

CATALOG &
TECHNICAL
GUIDE 2021.1



TURNING

>30,000

STANDARD PRODUCTS



>75

COUNTRIES



>4,100

DEDICATED EMPLOYEES



Headquartered in Fagersta, Sweden and present in more than 75 countries, Seco Tools is a leading global provider of metal cutting solutions for milling, stationary tools, holmaking and tooling systems.

For more than 80 years, the company has provided the technologies, processes and support that manufacturers depend on for maximum productivity and profitability. For more information on how Seco's innovative products and expert services bring success to manufacturers across all industry segments, please visit www.secotools.com.

Index

Tools.....	4-7
Inserts	8-9

General ISO Turning, product guidance

Index	10
Code keys – to read ISO & ANSI product codes	11-31
Choose Product Guidance – to choose turning products	32-71
Troubleshooting Guidance – to make turning products work better	72-81
Product Detail Guidance – to understand turning products in depth	82-148

General ISO Turning, toolholder products

QC Toolholders, external Jetstream Tooling®.....	150-158
Toolholders, external Seco-Capto™, Jetstream Tooling®.....	159-191
Toolholders, external Seco-Capto™.....	192-243
Toolholders, external Seco-Capto™, cassettes.....	244-246
Toolholders for MTM, Seco-Capto™	247-253
Toolholders, external, Jetstream Tooling®	254-277
Toolholders, external.....	278-410
Toolholders, internal Seco-Capto™	411-432
Toolholders, internal Seco-Capto™, Multi insert-pocket tools	433-434
Toolholders, internal.....	435-500
Toolholders for boring	501-503
Toolholders, cartridges	504-517
Cassettes for railway wheel re-turning (RWRT)	518-520

General ISO Turning, insert products

Inserts carbide	521-571
Inserts PCBN	572-596
Inserts PCBN with chipbreaker.....	597-598
Inserts PCD.....	599-602
Inserts ceramic	603-605

Steadyline® Turning, toolholder products

Steadyline®, damping holders for GL-heads.....	606-620
Steadyline®, GL-heads, internal Jetstream Tooling®.....	621-629
Steadyline®, GL-heads, internal	630-655
Steadyline®, GL-heads, MDT Jetstream Tooling®.....	656-659

MDT – Multi Directional Turning

General information	660-661
Application overview	662-678
Code keys	679-685
Product guidance	686-705
Trouble shooting.....	706-708
Cutting data.....	709-718
Toolholders, external, Jetstream Tooling®, Seco-Capto™	719-726

Toolholders, external axial, Jetstream Tooling®, Seco-Capto™	727-743
Toolholders, external, Jetstream Tooling®	744-758
Toolholders, external axial, Jetstream Tooling®	759-775
Toolholders, external Seco-Capto™	776-777
Toolholders, external	778-794
Toolholders, external axial	795-801
Toolholders, internal Seco-Capto™	802-808
Toolholders, internal	809-816
Toolholders for MTM, Jetstream Tooling®, Seco-Capto™	817
Holders, external for modular blades, Seco-Capto™	818-819
Holders, external for modular blades	820-821
Holders, internal for modular blades, Seco-Capto™	822-823
Holders, internal for modular blades	824-825
Blades, modular	826
Blades, modular axial	827-830
Reinforced blades, radial, Jetstream Tooling®	831
Reinforced blades, radial	832
Holder and blades	833
Blades for holder 150.10	834
Inserts carbide	835-852
Inserts PCBN	853-855

Mini-Shaft™ – Small part boring tools

General information	856-857
Code keys	858-860
Product guidance	861
Cutting data	862
Holders	863-864
Inserts	865-876

Grooving

Code keys	878-879
Product guidance	880-882
Cutting data	883-884
Toolholders for MTM, Seco-Capto™	885
Toolholders, external	886-891
Toolholders, internal	892-897
Toolholders MDT, ext. for Secomax ceramic inserts	898
Inserts carbide	899-905
Inserts ceramic	906

Parting-off – 150.10

Code keys	908
Product guidance	909-914
Cutting data	915-919
Toolholders and blades, Jetstream Tooling®	920-927
HSS- blades	928-930
Adapters, Seco-Capto™, Jetstream Tooling®	931-932
Adapters, HSK-T, Jetstream Tooling®	933
Adapters, VDI Jetstream Tooling®	934-935
Inserts	936-937

X4 – Multi edge parting & grooving tools

General information	938-939
Code keys	940-942
Product guidance	943-944
Cutting data.....	945-947
Toolholders, external – Jetstream Tooling® Duo, Seco-Capto™	948
Toolholders, external – Jetstream Tooling® Duo.....	949-951
Toolholders, external.....	952-953
Blades	954
Inserts carbide	955-959
Inserts PCBN	960

Adapters

Product guidance	961
Adapters for shank tools, Jetstream Tooling®, Seco-Capto™	962-968
Adapters for shank tools, Jetstream Tooling®, HSK-T.....	969-971
Adapters for shank tools, Jetstream Tooling®, VDI	972-973
Adapters for shank tools, Seco-Capto™	974-978
Mini-turret for shank tools, Seco-Capto™.....	979-980
Adapters for solid boring bars, Seco-Capto™	981-982
Adapters for solid boring bars.....	983
Adapters for boring tools.....	984

Seco-Capto™ clamping units

Product guidance	985-989
Type 2085	990
Type 2000/3000	991-992
Type VDI, angled.....	993-994
Type VDI, straight.....	995
Type 2090	996

Accessories and Spare parts

Spare parts, Seco-Capto™ Clamping units.....	997-1001
Accessories and Spare Parts, Jetstream Tooling®	1002
Accessories, Seco-Capto™	1003
Screw torque keys and Torque values	1004-1005

Workpiece material classifications – SMG..... 1006-1017

Declaration of conformity..... 1018-1020

General ISO Turning
Steadyline®
MDT
Mini-Shaft™
Grooving
Parting-off
X4
Adapters Clamping units
Accessories and Spare parts
Workpiece materials

1	
131-.....	984
132N.....	983
150.10...JETI.....	926-927
150.10A.....	928, 930
150.10A...JETI.....	920, 924-925
A	
A.-CGER/L.....	809-810
A.-CGFR/L.....	809-812
A.-CGGR/L.....	811-814
A.-CGHR/L.....	809-810, 815-816
A.-CGIR/L.....	811-812
A.-CGJR/L.....	809-810, 815-816
A.-DDUNR/L...-C.....	500
A.-DWLNR/L.....	436
A.-DWLNR/L...-C.....	435
A.-FR/L.....	824-825
A.-FR/L-V21.....	824
A.-MCLNR/L.....	480
A.-MDUNR/L.....	482
A.-MTFNR/L.....	486
A.-MVLNR/L.....	490
A.-MVPNR/L.....	490
A.-MVUNR/L.....	491
A.-MWLNR/L.....	494
A.-PCLNR/L.....	437-438
A.-PDQNR/L.....	461-462
A.-PDUNR/L.....	440-441
A.-PDYNR/L.....	468
A.-PTFNR/L.....	444-445
A.-PVLNR/L.....	446-447
A.-PVPNR/L.....	446-447
A.-PWLNR/L.....	448-449
A.-SCFCR/L.....	453
A.-SCFCR/L.....	450-451
A.-SCFCR/L...-R.....	450
A.-SCFDR/L.....	457
A.-SCLCR/L.....	453-455
A.-SCLCR/L...-R.....	454
A.-SCLDR/L.....	457
A.-SDQCR/L.....	459, 466
A.-SDQCR/L...-R.....	459
A.-SDQNR/L.....	461-462
A.-SDUCR/L.....	463-464, 466
A.-SDUCR/L...-R.....	463
A.-SDUNR/L.....	465, 467
A.-SDYNR/L.....	468
A.-SGXN.....	863-864
A.-SGXN...-R.....	863
A.-STFCR/L.....	469-471
A.-STFDR/L.....	473
A.-STLDR/L.....	473
A.-STUCR/L.....	471
A.-SVBUR/L.....	477
A.-SVQBR/L.....	475-477
A.-SVUBR/L.....	475
A.-SWLCR/L.....	478
ASHA-R/L...JETI.....	972-973
B	
BA...-GL.....	619
C	
C.-131.....	981-982
C.-150.10...JETI.....	932
C.-ASHA.....	975
C.-ASHA...-M.....	974
C.-ASHA...JETI.....	962-963
C.-ASHR/L.....	976, 978-980
C.-ASHR/L...JETI.....	964-965, 967-968
C.-ASHS.....	977
C.-ASHS...JETI.....	966
C.-CCLNR/L.....	236-237
C.-CDIR/L...JETI.....	817
C.-CER/L.....	885
C.-CER/L...-HD.....	885
C.-CFIR/L.....	776-777
C.-CFIR/L...JETI.....	719-720, 727-731
C.-CFMR/L...JETI.....	721-722
C.-CFOR/L...JETI.....	723-724, 732-743
C.-CFXN...RBJET.....	726
C.-CFZN...RBJET.....	726
C.-CFZR/L...RBJET.....	725
C.-CGER/L.....	802-803
C.-CGFR/L.....	802-805
C.-CGGR/L.....	804-805, 807-808
C.-CGHR/L.....	802-803, 806
C.-CGIR/L.....	804-805
C.-CGJR/L.....	802-803, 806
C.-CRSNR/L.....	238-239
C.-CRSNR/L...-C.....	243
C.-CSDNN.....	240
C.-CSRNR/L.....	241
C.-CTJNR/L.....	242
C.-CTUNR/L.....	432
C.-CXXXR/L-CT10.....	244
C.-D...-BA.....	612
C.-D...-GL.....	610-611
C.-DCKNR/L...-M.....	192-193
C.-DCLCR/L...JETI.....	159-160
C.-DCLNR/L.....	194-195
C.-DCLNR/L...JETI.....	161-162
C.-DCMNN...-M.....	247
C.-DCRNR/L.....	196
C.-DCRNR/L...-M.....	196-197
C.-DCRNR/L...JETI.....	163
C.-DDJCR/L...JETI.....	164
C.-DDJNR/L.....	198-199
C.-DDJNR/L...-M.....	198-199
C.-DDJNR/L...JETI.....	165-166
C.-DDMNR/L...-M.....	248
C.-DDNN...-M.....	200
C.-DDUNR/L.....	201-202
C.-DDUNR/L...-M.....	201-202
C.-DDUNR/L...JETI.....	167
C.-DRSNR/L...-M.....	203
C.-DSDNN...-M.....	204-205
C.-DSKNR/L.....	206
C.-DSKNR/L...-M.....	206
C.-DSKNR/L-PCLNR/L.....	433
C.-DSRNR/L.....	207-208
C.-DSRNR/L...-M.....	207-208
C.-DSSNR/L.....	209-210
C.-DSSNR/L...-M.....	209-210
C.-DSSNR/L...JETI.....	168-169
C.-DTFNR/L...-M.....	211
C.-DTGNR/L...-M.....	212
C.-DTJNR/L...-M.....	213
C.-DTJNR/L...JETI.....	170
C.-DVHBR/L...JETI.....	171
C.-DVJBR/L...JETI.....	172-173
C.-DVJNR/L.....	214
C.-DVJNR/L...JETI.....	174-175
C.-DVMNL...-M.....	249
C.-DVVBN...JETI.....	176
C.-DWLNR/L.....	215-216
C.-DWLNR/L...JETI.....	177-178
C.-FL-V21.....	818, 822
C.-FR-V21.....	818, 822-823
C.-GL-V21.....	818
C.-GR-V21.....	818-819
C.-LC2030...-M.....	993, 995
C.-LC2040.....	993, 995
C.-LC2050.....	993, 995
C.-LC2060.....	993-995
C.-LC2085.....	990

C.-LC2085..-M	990
C.-LC2090	996
C.-LC2090..-M	996
C.-MSKNR/L-PCLNR/L	434
C.-MVUNR/L	416-417
C.-NC2000	991-992
C.-NC3000	991-992
C.-PCLNR/L	217-218, 411-412
C.-PCLNR/L...JETL	179-180
C.-PDJNR/L...JETL	181-182
C.-PDQNR/L	422-423
C.-PDUNR/L	413-414, 427-428
C.-PSDNN	219
C.-PSKNR/L	220
C.-PSRNR/L	221
C.-PTFNR/L..-W	415
C.-PTJNR/L...JETL	183
C.-PVJNR/L...JETL	184
C.-PVUNR/L	416-417
C.-PWLNN	250
C.-PWLNR/L	222-223, 418-419
C.-PWLNR/L...JETL	185-186
C.-R/L150.10...JETI	931
C.-R/LC2030..-M	993, 995
C.-R/LC2040	993, 995
C.-R/LC2050	993, 995
C.-R/LC2060	993-995
C.-R/LC2085	990
C.-R/LC2085..-M	990
C.-R/LC2090	996
C.-R/LC2090..-M	996
C.-SCLCR/L	224-225, 420-421
C.-SCLCR/L...JET	187-188
C.-SCMCN	251
C.-SDJCR/L	226
C.-SDJCR/L...JET	189
C.-SDNCN	227
C.-SDQNR/L	422-423
C.-SDUCR/L	424-425
C.-SDUCR/L..-X	426
C.-SDUNR/L	427-428
C.-SR/L-V21	818
C.-SRDCN	252
C.-SRDCN..-A	228-229
C.-SRSCR/L	230-231
C.-SRSCR/L...JET	190
C.-SR-V21	818
C.-STFCR/L	429
C.-SVHBR/L	232
C.-SVJBR/L	233-234
C.-SVJBR/L...JET	191
C.-SVMBR/L	253
C.-SVQBR/L	430-431
C.-SVVBN	235
C.-X4FR/L...JET	948
CCBNR/L	392
CCLNR/L	392
CCLNR/L..-C	393
CDJNR/L	394
CDNNN	394
CEAR/L	891
CEAR/L...D	890
CEAR/L...HD	890
CEAR/L...QHD	890
CEAR/L...QHD	890
CER/L...D	886-887
CER/L...QHD	886-887
CER/L..-Q	888-889
CER/L..-QHD	888-889
CFHN	833
CFIN	833
CFIR/L	778-781, 795-798
CFIR/L...JET	746, 763
CFIR/L...JETI	744-745, 759, 761-762

CFIR/L...JET	747-748, 760, 764-765
CFJN	833
CFKN	833-834
CFKR/L..-M..-C	898
CFLN	833
CFLR/L..-M..-C	898
CFMN	834
CFMR/L	782-785
CFMR/L...JET	749
CFMR/L...JETI	752
CFMR/L...JET	750-751
CFNN	833
CFON	834
CFOR/L	786, 789-790
CFOR/L...JET	753, 768, 773
CFOR/L...JETI	766-767, 771-772
CFOR/L..-C	898
CFOR/L...JET	754, 769-770, 774-775
CFOR/L.ITX...JET	831
CFPR/L	786-787
CFQR/L.ITX...JET	831
CFSR/L	789-792
CFSR/L...JETI	755
CFSR/L..-JET	756
CFTR/L	786-787
CFTR/L.ITX	832
CFTR/L.ITX...JET	831
CFXR/L.ITX	832
CFZR/L	793-794
CFZR/L...JETI	757
CFZR/L..-JET	758
CFZR/L.ITX	832
CFZR/L.ITX...JET	831
CGIR/L	799-801
CIIR/L	788
CNR/L	896-897
CNR/L...A	894-895
CNR/L...DA	894-895
CNR/L..-AHD	896-897
CNR/L..-H	896-897
CNR/L...AHD	894-895
CRDCN..-C	395
CRDCR/L..-C	395
CRDNN	396, 398
CRDNN..-C	400
CRSNR/L	398-399
CRSNR/L..-C	400
CSBNR/L	401
CSDNN	402-403
CSKNR/L	402
CSRNR/L	401
CSSNR/L	404
CT..-CCLNX	245
CT..-CRSNX	246
CTFNR/L	406-407
CTGNR/L	397
CTGNR/L..-PL	405
CTJNR/L	406-407
CT-PLANR/L	518
CT-PLFNR/L	520
CVVNN	408

D

D..-BA	618
D..-GL	613-614
DA..-GL	615-616
DCBNR/L...JETI	254
DCBNR/L..-M	278-279
DCKNR/L	281
DCKNR/L..-M	280
DCLCR/L...JETI	255
DCLCR/L..-XJETI	256-257
DCLNR/L	284-285
DCLNR/L...JETI	258

General ISO Turning

Steadyline®

MDT

Mini-Shaft™

Grooving

Parting-off

X4

Adapters
Clamping units

Accessories and
Spare parts

Workpiece
materials

General ISO Turning

Steadyline®

MDT

Mini-Shaft™

Grooving

Parting-off

X4

Adapters
Clamping units

Accessories and
Spare parts

Workpiece
materials

DCLNR/L...-M	282-283
DCLNR/L...XJETI	259
DDHNR/L	286
DDJCR/L...JETI	260
DDJCR/L...XJETI	261
DDJNR/L	287-288
DDJNR/L...JETI	262-263
DDJNR/L...-C	289
DDJNR/L...-M	287
DDJNR/L...XJETI	264
DDNN...-C	289
DDPNN	290
DDQNR/L	291
DRGNR/L	292
DRSNR/L...-M	293
DSBnr/L...-C	409
DSBnr/L...-M	294
DSDNN	296
DSDNN...-M	295
DSKnr/L	298
DSKnr/L...-M	297
DSSnr/L	301
DSSnr/L...-C	409
DSSnr/L...JETI	265
DSSnr/L...-M	299-300
DSSnr/L...XJETI	266
DTFnr/L	303
DTFnr/L...-M	302
DTGnr/L	305
DTGnr/L...-M	304
DTJnr/L	306
DTJnr/L...JETI	267
DTJnr/L...XJETI	268
DVJBR/L...JETI	269
DVJBR/L...XJETI	270
DVJnr/L	307-308
DVJnr/L...JETI	271
DVJnr/L...XJETI	272
DVPnr/L	309-310
DWLnr/L	311-312
DWLnr/L...JETI	273-274
DWLnr/L...-C	410
DWLnr/L...XJETI	275
E	
E...SCFCR/L...-R	452
E...SCLCR/L	456
E...SGXN	863-864
E...SGXN...-R	863
E...STFCR/L	472
E9364-ASHA...JETI	969-970
E9364-ASHR/L...JETI	971
E9364-R/L150.10...JETI	933
E9374-D...-GL	607-608
E9376-D...-BA	609
E9376-D...-GL	607
F	
FR/L	820-821
G	
GL...-CCLNR/L	653
GL...-CGGR/L...JETI	658
GL...-CGHR/L...JETI	659
GL...-CGIR/L...JETI	656, 659
GL...-CGJR/L...JETI	657
GL...-CRSNR/L	654
GL...-CTUNR/L	655
GL...-DCLCR/L...JETI	621
GL...-DCLNR/L	630-631
GL...-DCLNR/L...JETI	622
GL...-DDUCR/L...JETI	623-624
GL...-DDUNR/L	632-633
GL...-DDUNR/L...JETI	625-626

GL...-DVUBR/L...JETI	627-628
GL...-DWLNR/L	634-635
GL...-DWLNR/L...JETI	629
GL...-SCLCR/L	636-638
GL...-SDUCR/L	639-640
GL...-SDUCR/L...-X	641-642
GL...-SDUNR/L	643
GL...-SDXCR/L	645-646
GL...-STFCR/L	648-649
GL...-SVUBR/L	650-651
GL...-SVUNR/L	652
GR/L	820-821

H

H...-SCLDR/L	458
H...-STLDR/L	474
HSKTA...-GL	607-608

M

MCFnr/L...CA	513
MCKnr/L	367
MCLnr/L	368
MCLnr/L...CA	513
MCMNN	369
MCRnr/L	370
MDJnr/L	371
MRGnr/L	372
MRGOR/L	373
MSBnr/L	374
MSDNN	375
MSKnr/L...CA	514-515
MSRnr	376
MSRnr/L	377
MSSnr/L...CA	514
MSSnr/L...CX	515
MSTnr/L...CX	515
MTCNN	378
MTENNS	379
MTFnr/L	380
MTFnr/L...CA	516
MTFnr/L...CX	517
MTGnr/L	381
MTJnr/L.S	382
MTLnr/L	383
MVJnr/L	384
MVLnr/L	385
MVTnr/L	386
MWLnr/L	387-388

N

N...F-QC	150-152
----------	---------

P

PCBnr/L	313
PCLnr/L	314-315
PDJnr/L	316
PDNNR/L	317
PRDCN	318
PROON	319
PSBnr/L	320-321
PSDNN	322
PSKnr/L	322
PSSnr/L	323
PSYnr/L	324
PTAR/L	324
PTBnr/L	325
PTGnr/L	326-327
PTGnr/L...-A	326-327
PTJnr/L	328-329
PTNNR/L	325, 330
PWLnr/L	331

Q

QC...-CFOR/L...JETI	156
---------------------	-----

QC..-PER/L..HDJET 158
 QC..-R/L150.10...JETI 157
 QC..-SCLCR/L...JET 153
 QC..-SDJCR/L...JET 154
 QC..-SVJBR/L...JET 155

R

R/L150.10 929
 R/L150.10...JETI 921-922
 R/L150.10A 928, 930
 R/L150.10A...JETI 920
 R/L150.10-VDI...JETI 934-935
 R/L150.10X...JETI 923
 R/L175.32 519

S

S..-CCLNR/L 496
 S..-CRSNR/L 497
 S..-CSKNR/L 498
 S..-CTUNR/L 499
 S..-MCLNR/L 479, 481
 S..-MDUNR/L 483
 S..-MSKNR/L 484
 S..-MTFNR/L 485, 487
 S..-MTUNR/L 488
 S..-MVLNR/L 489
 S..-MVPNR/L 489
 S..-MVYNR/L 492
 S..-MWLNR/L 493, 495
 S..-PCLNR/L 439
 S..-PDUNR/L 442
 S..-PSKNR/L 443
 S..-SCACR/L 502
 S..-SCDCR/L 503
 S..-SCECR/L 502
 S..-SCLDR/L 458
 S..-SDQCR/L 460
 S..-STFDR/L 474
 S..-STLDR/L 474
 SCACR/L 332, 501
 SCBCR/L 333
 SCDCR/L 334
 SCECL 501
 SCFCR/L 334
 SCFCR/L..CA 504-505
 SCGCR/L 335-336
 SCGCR/L..CA 506
 SCLCR/L 337-338
 SCLCR/L..CA 504-505
 SCMCN 339
 SCRCR/L 340
 SCRCR/L..CA 507
 SCSCR/L..CA 506
 SCTCR/L..CA 507
 SCWCR/L..CA 504
 SDACR/L 341
 SDHCR/L 342
 SDJCR/L 343-345
 SDNCN 346
 SDPCN 347
 SFN 833
 SL16 984
 SNR/L 892-893
 SR/L 821
 SR/L..-V21 820
 SRDCN 348-350
 SRGCR/L 351
 SRSCR/L 352-353
 SRSCR/L...JET 276
 SRSCR/L...JET 277
 SSBCL/L 356
 SSDCN 354-355
 SSKCR/L..CA 508
 STFCR/L 357

STFCR/L..CA 509-510
 STGCR/L 357-359
 STGCR/L..CA 511-512
 STJCR/L 360
 STRCR/L..CA 511
 STSCR/L..CA 509-510
 STTCR/L..CA 511
 STWCR/L..CA 509
 SVABR/L 362
 SVJBR/L 361
 SVJCR/L 362
 SVLBR/L 363-364
 SVVBN 364-365
 SWLCR/L 366

T

TRAOR/L 389-390
 TRDON 389
 TRGOR/L 391
 TROON 390

V

V21-CHR/L 827-830
 V21-CIR/L 826-830
 V21-CJR/L 827, 829
 V21-CKR/L 827, 829
 V21-CMR/L 826, 828, 830
 V21-COR/L 827, 829

X

X4FR/L 952-953
 X4FR/L...JET 950
 X4FR/L...JETI 949
 X4FR/L...JET 951
 X4FR/L.ITX 954

General ISO Turning
 Steadyline®
 MDT
 Mini-Shaft™
 Grooving
 Parting-off
 X4
 Adapters
 Clamping units
 Accessories and
 Spare parts
 Workpiece
 materials

General ISO Turning
Steadyline®
MDT
Mini-Shaft™
Grooving
Parting-off
X4
Adapters
Clamping units
Accessories and
Spare parts
Workpiece
materials

1
10EAR/L
 ..FA 901
10ER
 ..D76 903
 ..FD 902
 ..FG 900
 ..R 903
10FG 900
12EAR
 ..FD 901
12ER
 ..FD 902
14EAR
 ..AX 904
 ..FA 901
14ER
 ..D76 903
 ..DY 905
 ..FG 900
 ..R 903
 ..ST 904
150.10 936-937

2
20EAR
 ..AX 904
 ..FA 901
20ER
 ..D76 903
 ..DY 905
 ..FG 900
 ..R 903
 ..ST 904
26ER
 ..FG 900
 ..R 903
 ..ST 904

9
9NR/L
 ..FG 899

C
CCGT 522-524, 597
CCGW 573-574
CCGX 522-523
CCMT 522-525
CCMW 599
CDCB 526
CNGA 575-576
CNGG 527-528
CNGM 597
CNGN 603
CNMA 527-532
CNMG 527-533
CNMM 527, 529-533
CNMN 577

D
DCGT 534-536
DCGW 578
DCMT 534-536
DCMW 600
DCMX 534-536
DNGA 579
DNGG 537-538
DNGM 537-539, 598
DNGN 580
DNMA 537-540, 580
DNMG 537-541
DNMM 537, 540-541
DNMN 581

DNMU 537-538
DNMX 537-540

L
LCEX 865-876
LCGA 837
LCGF 836, 845-847
LCGN 847-855
LCMF 835-836, 838-842
LCMR 835-836, 841, 843-844
LNMX 542-543
LPGN 906

R
RCGN 600
RCGS 544, 581
RCGX 603
RCMM 545-546
RCMT 545-546
RCMX 545-546
RNGN 582, 601, 604
RNGN-LF 582
RNMA 547
RNMG 547
RNMN 583
RPGN 604
RPGX 605

S
SCGW 584
SCMN 584
SCMT 548-549
SNGA 585
SNGF 585
SNGN 586
SNMA 550-552
SNMG 550-553
SNMM 550-553
SNMN 587
SNUN 554
SPGW 588

T
TCGN 588
TCGT 555-556
TCGW 589
TCGX 555
TCMT 555-556
TCMW 601
TCMX 555-556
TDAB 557
TDCH 557
TNGA 590
TNGN 591
TNGX 592
TNMA 558-561
TNMG 558-561
TNMM 558-561
TNMN 592
TNMX 558-560, 593
TPGN 593, 602
TPMM 562

V
VBGT 563-564
VBGW 594
VBMT 563-564
VBMW 602
VCGT 564
VNGA 595
VNGG 565-566
VNGM 565
VNMA 565-566, 595
VNMG 565-566

VNMU	565
W	
WCMT	567
WNGA	596
WNGG	568-570
WNMA	568-571, 596
WNMG	568-571
WNMM	568, 570-571
X	
X4G	960
X4GK	955-959

General ISO Turning
Steadyline ®
MDT
Mini-Shaft™
Grooving
Parting-off
X4
Adapters Clamping units
Accessories and Spare parts
Workpiece materials

General ISO Turning

Steadyline®

MDT

Mini-Shaft™

Grooving

Parting-off

X4

Adapters
Clamping units

Accessories and
Spare parts

Workpiece
materials

Code keys – to read ISO & ANSI product codes

Seco-Capto™ – External toolholders – Metric 11-12
 Seco-Capto™ – Internal toolholders and modular GL-turning heads – Metric 13-14
 External toolholders – Metric (ISO) 15-16
 External toolholders – Inch (ANSI) 17-18
 Internal toolholders – Metric (ISO) 19-20
 Internal toolholders – Inch (ANSI) 21-22
 Cartridges – Inch (ANSI) 23-24
 Coolant clamps for toolholders and modular turning heads 25
 Insert series, Extract from ISO 1832 – Metric (ISO) 26-28
 Insert series, Extract from ANSI B212 – Inch (ANSI) 29-31

Choose Product Guidance – to choose turning products

Introduction to choose product 32
 First steps 32-38
 Application overview 39-60
 Chipbreaker application areas 61-62
 High Feed Wiper inserts 63
 Searching Turning Tools 64
 Searching using filter options 65
 Exploring cutting data recommendations 66
 Component based product recommendations 67
 Insert grades – Carbide 68
 Introduction – PCBN 69
 Introduction – PCD 70
 Introduction – Ceramic 71

Troubleshooting Guidance – to make turning products work better

Turning problems & recommended solutions 72
 Optimization – Carbide insert wear 73
 Carbide insert wear and failure modes 74-77
 Optimisation – Carbide grades 78
 PCBN 79
 PCD 80
 Ceramic 81

Product Detail Guidance – to understand turning products in depth

ISO attributes 82-83
 Toolholder clamping 84
 Jetstream Tooling® 85-89
 Seco-Capto™ 90-91
 Steadyline® 92-96
 Toolholder QC Modular 97-98
 Shims & shim screws for alternate use 99
 Small diameter boring – Introduction 100
 Cutting data, Nomenclature and Formulae 101-102
 Cutting data, Workpiece materials 103
 Cutting data, ISO carbide Inserts 104-108
 Cutting data, Rainway wheels 109
 Inserts packaging 110
 Inserts Carbide chipbreakers 111-115
 Inserts Carbide High Feed Wiper 116-118
 Inserts Carbide grades 119-121
 Cartridges – Mounting information 122
 Railway Wheel Turning 123-125
 PCBN 126-141
 PCD 142-144
 Ceramic 145-148

Seco-Capto™ – External toolholders – Metric

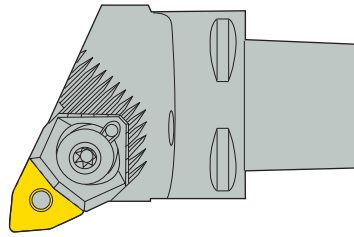

C4	-	P	W	L	N	R	-	27	050	-	06	-	
1		2	3	4	5	6		7	8		9		10

1. Seco-Capto™ and QC size

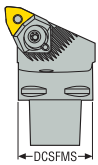

- C3 = 32 mm / 1.260 inch
- C4 = 40 mm / 1.575 inch
- C5 = 50 mm / 1.969 inch
- C6 = 63 mm / 2.480 inch
- C8 = 80 mm / 3.150 inch
- C10 = 100 mm / 3.937 inch

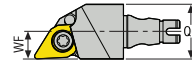

- QC12 = WF 6 mm / 0.240 inch
- QC16 = WF 8 mm / 0.315 inch

2. Insert clamping

D	P	M	S	C
Clamp/inserts with centre hole	Pin/Wedge or Lever	Pin/Clamp	Screw	Clamp

3. Insert shape

A	B	C	D	E	H	K	L
M	O	P	R	S	T	V	W

4. Tool type

A	B	D	F	G	H	J	K
L	N	P	R	S	T	V	

General ISO Turning
Technical information

Steadyline®

MDT

Mini-Shaft™

Grooving

Parting-off

X4

Adapters
Clamping units

Accessories and
Spare parts

Workpiece
materials

General ISO Turning
Technical information

Steadyline®

MDT

Mini-Shaft™

Grooving

Parting-off

X4

Adapters
Clamping units

Accessories and
Spare parts

Workpiece
materials

5. Insert side clearance angle

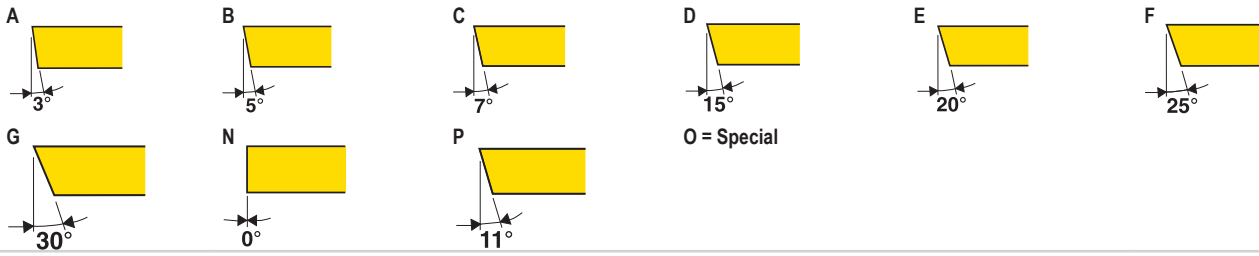

6. Cutting direction

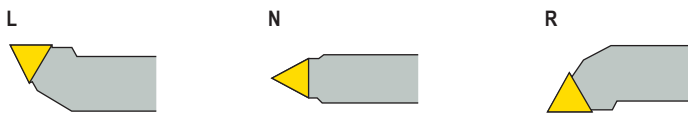

7. WF-dimension

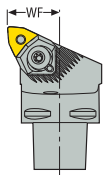

22 = 22 mm / 0.866 inch
27 = 27 mm / 1.063 inch
35 = 35 mm / 1.378 inch
45 = 45 mm / 1.772 inch
etc.

N/A for QC toolholder

8. LF-dimension

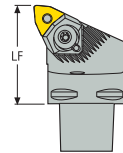

040 = 40 mm / 1.575 inch
042 = 42 mm / 1.654 inch
044 = 44 mm / 1.732 inch
050 = 50 mm / 1.969 inch
060 = 60 mm / 2.362 inch
etc.

N/A for QC toolholder

9. Cutting edge length



10. Internal designation

JET = Jetstream Tooling®
JETI = Jetstream Tooling® integrated coolant inlet
JETL = Jetstream Tooling® with P-lever clamp

-PL = Plunging
X = Back boring

Seco-Capto™ – Internal toolholders and modular GL-turning heads – Metric

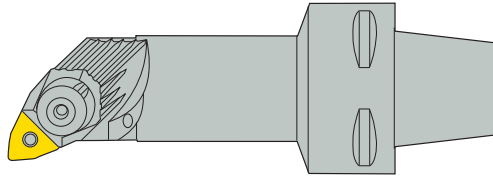

C4	P	W	L	N	R	- 13	080	- 06	
1	2	3	4	5	6	7	8	9	10

1. Seco-Capto™ and GL size

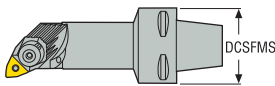

C3 = 32 mm / 1.260 inch
C4 = 40 mm / 1.575 inch
C5 = 50 mm / 1.969 inch
C6 = 63 mm / 2.480 inch
C8 = 80 mm / 3.150 inch

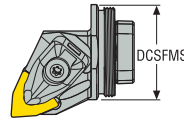

GL25 = 25 mm / 0.984 inch
GL32 = 32 mm / 1.260 inch
GL40 = 40 mm / 1.575 inch
GL50 = 50 mm / 1.969 inch

2. Insert clamping

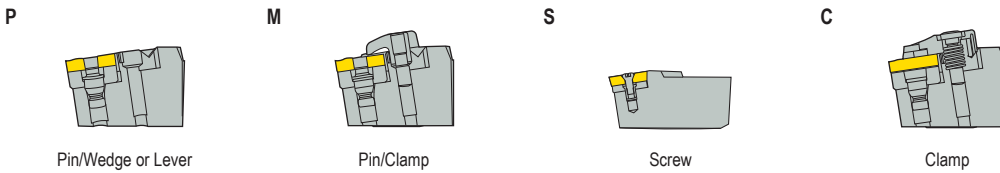

3. Insert shape

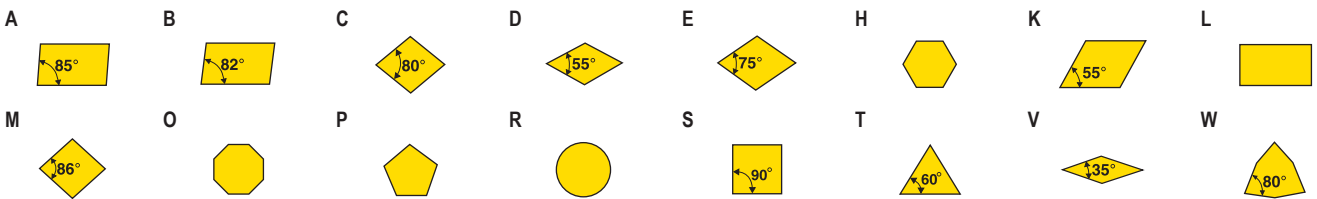

4. Tool type

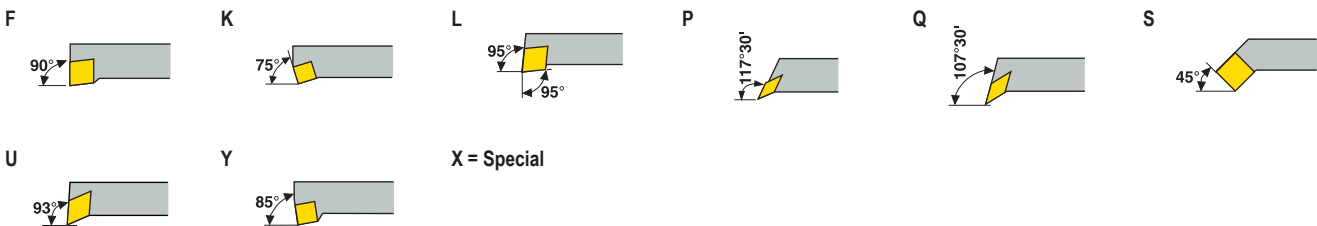

General ISO Turning
Technical information

Steadyline®

MDT

Mini-Shaft™

Grooving

Parting-off

X4

Adapters
Clamping units

Accessories and
Spare parts

Workpiece
materials

General ISO Turning
Technical information

5. Insert side clearance angle

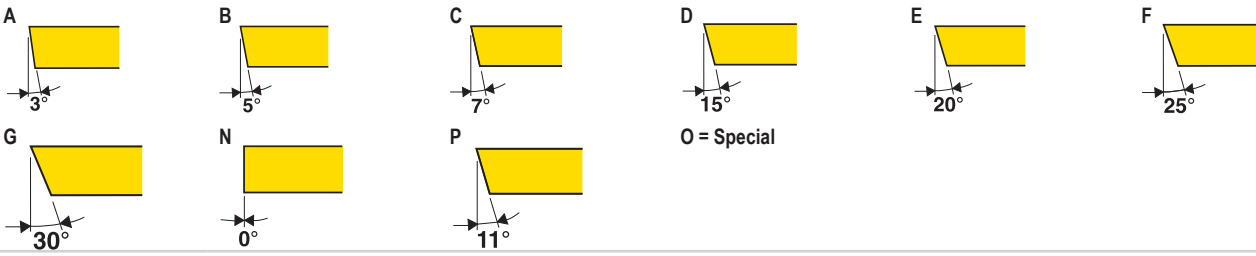

Steadyline®

6. Cutting direction



MDT

7. WF-dimension

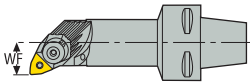

11 = 11 mm / 0.433 inch
13 = 13 mm / 0.512 inch
17 = 17 mm / 0.669 inch
22 = 22 mm / 0.866 inch
etc.

8. LF-dimension

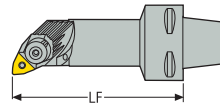

064 = 64 mm / 2.520 inch
065 = 65 mm / 2.559 inch
070 = 70 mm / 2.756 inch
075 = 75 mm / 2.953 inch
etc.

Mini-Shaft™

9. Cutting edge length

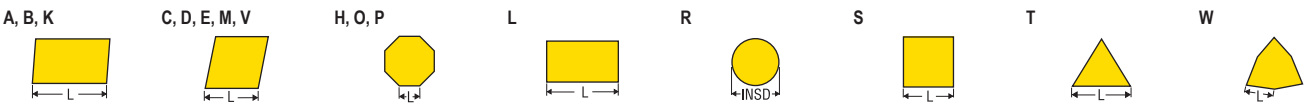

Grooving

10. Internal designation

PL = Plunging
X = Back boring
JET = Jetstream Tooling®
JETI = Jetstream Tooling® integrated coolant inlet

Parting-off

X4

Adapters
Clamping units

Accessories and
Spare parts

Workpiece
materials

External toolholders – Metric (ISO)



D	W	L	N	R	25	25	X	06	JETI
1	2	3	4	5	6	7	8	9	10

1. Insert clamping

D	P	M	S	C
Clamp/inserts with centre hole	Pin/Wedge or Lever	Pin/Clamp	Screw	Clamp

2. Insert shape

A	B	C	D	E	H	K	L
M	O	P	R	S	T	V	W

3. Tool type

A	B	D	F	G	H	J	K
L	N	P	R	S	T	V	

4. Insert side clearance angle

A	B	C	D	E	F
G	N	P	O = Special		

General ISO Turning
Technical information

Steadyline®

MDT

Mini-Shaft™

Grooving

Parting-off

X4

Adapters
Clamping units

Accessories and
Spare parts

Workpiece
materials

General ISO Turning
Technical information

5. Cutting direction

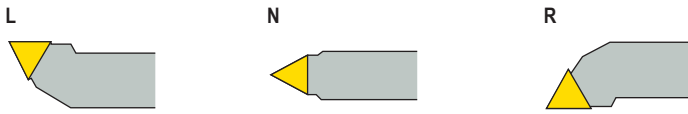

Steadyline®

6. Shank height

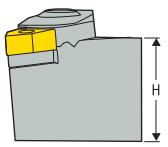

12 = 12 mm / 0.470 inch
25 = 25 mm / 0.984 inch
32 = 32 mm / 1.260 inch
etc.

7. Shank width

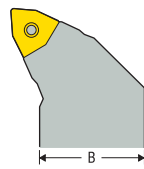

12 = 12 mm / 0.470 inch
25 = 25 mm / 0.984 inch
32 = 32 mm / 1.260 inch
etc.

MDT

8. Tool length

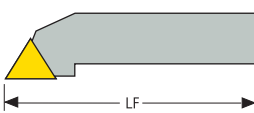

A = 32 mm / 1.260 inch
C = 50 mm / 1.969 inch
D = 60 mm / 2.362 inch
E = 70 mm / 2.756 inch
F = 80 mm / 3.150 inch

H = 100 mm / 3.937 inch
K = 125 mm / 4.921 inch
M = 150 mm / 5.906 inch
P = 170 mm / 6.693 inch
R = 200 mm / 7.874 inch

S = 250 mm / 9.843 inch
T = 300 mm / 11.811 inch
V = 400 mm / 15.748 inch
X = Special

Standard length as above

Mini-Shaft™

Grooving

9. Cutting edge length

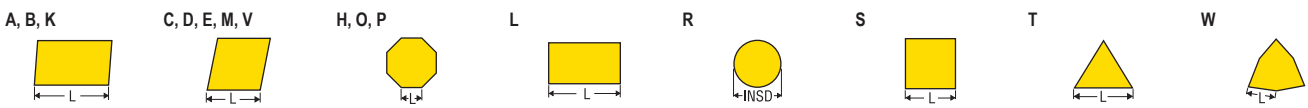

Parting-off

10. Internal designation

JET = Jetstream Tooling®
JETI = Jetstream Tooling® integrated coolant inlet
JETL = Jetstream Tooling® with P-lever clamp

-PL = Plunging

X4

Adapters
Clamping units

Accessories and
Spare parts

Workpiece
materials

External toolholders – Inch (ANSI)

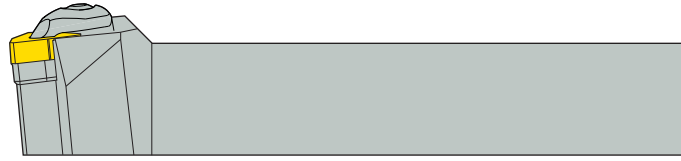

D	W	L	N	R		- 16 -	3	C	
1	2	3	4	5	6	7	8	9	10

1. Insert clamping

D	P	M	S	C	T
Clamp/inserts with centre hole	Pin/Wedge or Lever	Pin/Clamp	Screw	Clamp	Tapered stem (Tee-lock)

2. Insert shape

A	B	C	D	E	H	K	L
M	O	P	R	S	T	V	W

3. Tool type

A	B	D	F	G	H	J	K
ANSI lead = 0°	ANSI lead = 15°	ANSI lead = 45°	ANSI lead = 0°	ANSI lead = 0°		ANSI lead = -3°	ANSI lead = 15°
L	N	P	R	S	T	V	
ANSI lead = -5°	ANSI lead = 27°30'	ANSI lead = -27°30'	ANSI lead = 15°	ANSI lead = 45°	ANSI lead = 30°	ANSI lead = 17°30'	

4. Insert side clearance angle

A	B	C	D	E	F
G	N	P	O = Special		

General ISO Turning
Technical information

Steadyline®

MDT

Mini-Shaft™

Grooving

Parting-off

X4

Adapters
Clamping units

Accessories and
Spare parts

Workpiece
materials

General ISO Turning
Technical information

5. Cutting direction

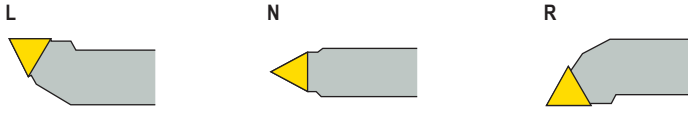

Steadyline®

6. Pocket style

S = Single wall pocket construction
Full pocket construction when letter position is vacant

7. Toolholder shank size

For square shanks, the number represents the number of sixteenths of width and height. For rectangular shanks, the first digit represents the number of eighths of width and the second digit represents the number of quarters of height.

MDT

8. Insert size I.C.

Number of eighths of I.C.

9. Qualified surface & length

- | | |
|---------------------------------------|--|
| A = Qualified back and end. 4" long | M = Qualified front and end. 4" long |
| B = Qualified back and end. 4.5" long | N = Qualified front and end. 4.5" long |
| C = Qualified back and end. 5" long | P = Qualified front and end. 5" long |
| D = Qualified back and end. 6" long | R = Qualified front and end. 6" long |
| E = Qualified back and end. 7" long | S = Qualified front and end. 7" long |
| F = Qualified back and end. 8" long | T = Qualified front and end. 8" long |
| J = Qualified back and end. 3.5" long | X = Special length |

Mini-Shaft™

10. Internal designation

JET = Jetstream Tooling®
 JETI = Jetstream Tooling® integrated coolant inlet
 JETL = Jetstream Tooling® with P-lever clamp
 -PL = Plunging

Grooving

Parting-off

X4

Adapters
Clamping units

Accessories and
Spare parts

Workpiece
materials



Internal toolholders – Metric (ISO)



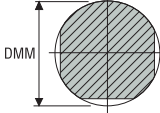

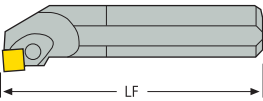

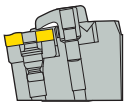

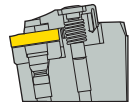









A	20	Q	-	P	W	L	N	R	06	R
1	2	3		4	5	6	7	8	9	10

1. Toolholder type	2. Shank diameter
<p>A = Steel with coolant passage</p> <p>S = Solid steel</p> <p>E = Solid carbide with brazed* cutting head and coolant passage</p> <p>* Brazed or equivalent</p>	 <p>12 = 12 mm / 0.470 inch 20 = 20 mm / 0.787 inch 25 = 25 mm / 0.984 inch etc.</p>

3. Tool length
 <p>K = 125 mm / 4.921 inch L = 140 mm / 5.512 inch M = 150 mm / 5.906 inch N = 160 mm / 6.299 inch P = 170 mm / 6.693 inch Q = 180 mm / 7.087 inch</p> <p>R = 200 mm / 7.874 inch S = 250 mm / 9.843 inch T = 300 mm / 11.811 inch U = 350 mm / 13.780 inch</p> <p>Standard length as above</p>

4. Insert clamping			
P	M	S	C
			
Pin/Wedge or Lever	Pin/Clamp	Screw	Clamp

5. Insert shape							
A	B	C	D	E	H	K	L
							
M	O	P	R	S	T	V	W
							

General ISO Turning
Technical information

Steadyline®

MDT

Mini-Shaft™

Grooving

Parting-off

X4

Adapters
Clamping units

Accessories and
Spare parts

Workpiece
materials

General ISO Turning
Technical information

Steadyline®

MDT

Mini-Shaft™

Grooving

Parting-off

X4

Adapters
Clamping units

Accessories and
Spare parts

Workpiece
materials

6. Tool type

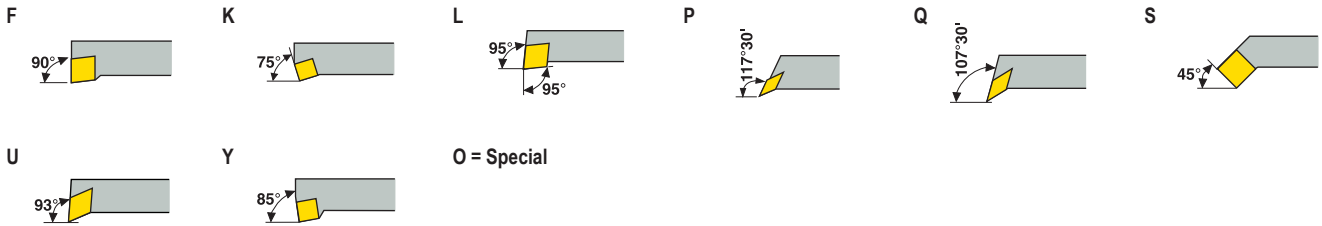

7. Insert side clearance angle

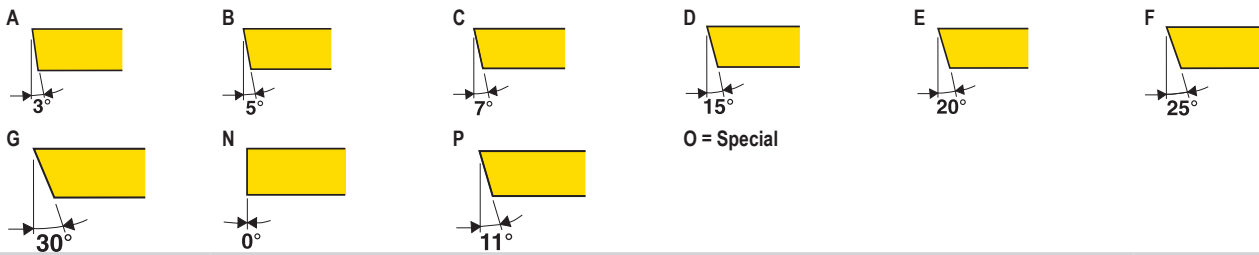

8. Cutting direction



9. Cutting edge length

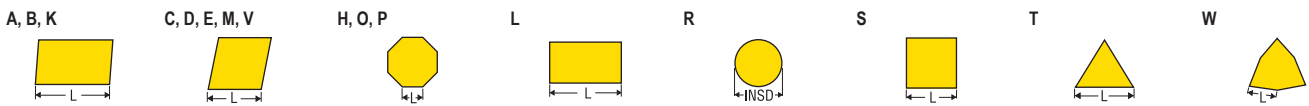

10. Internal designation

R = Round
W = Wedge clamping
PL = Plunging
X = Back boring

Internal toolholders – Inch (ANSI)

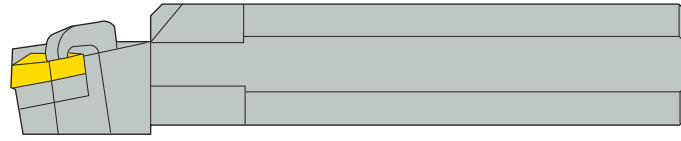

S	16		M	W	L	N	R	3
1	2	3	4	5	6	7	8	9

1. Toolholder type	2. Shank diameter
A = Steel with coolant passage C = Carbide E = Solid carbide with brazed* cutting head and coolant passage H = Heavy metal J = Heavy metal with coolant hole S = Solid steel * Brazed or equivalent	<p>Indicates bar diameter in sixteenths of an inch Stepped bar shows smallest diameter first</p>

3. Tool length
<div style="display: flex; justify-content: space-between;"> <div style="width: 45%;"> <p>K = 125 mm / 4.921 inch L = 140 mm / 5.512 inch M = 150 mm / 5.906 inch N = 160 mm / 6.299 inch P = 170 mm / 6.693 inch Q = 180 mm / 7.087 inch</p> <p>Standard length as above</p> </div> <div style="width: 45%;"> <p>R = 200 mm / 7.874 inch S = 250 mm / 9.843 inch T = 300 mm / 11.811 inch U = 350 mm / 13.780 inch</p> </div> </div>

4. Insert clamping
<div style="display: flex; justify-content: space-around;"> <div style="text-align: center;"> <p>P</p> <p>Pin/Wedge or Lever</p> </div> <div style="text-align: center;"> <p>M</p> <p>Pin/Clamp</p> </div> <div style="text-align: center;"> <p>S</p> <p>Screw</p> </div> <div style="text-align: center;"> <p>C</p> <p>Clamp</p> </div> </div>

5. Insert shape
<div style="display: grid; grid-template-columns: repeat(8, 1fr); gap: 10px;"> <!-- Row 1 --> <div style="text-align: center;"> <p>A</p> </div> <div style="text-align: center;"> <p>B</p> </div> <div style="text-align: center;"> <p>C</p> </div> <div style="text-align: center;"> <p>D</p> </div> <div style="text-align: center;"> <p>E</p> </div> <div style="text-align: center;"> <p>H</p> </div> <div style="text-align: center;"> <p>K</p> </div> <div style="text-align: center;"> <p>L</p> </div> <!-- Row 2 --> <div style="text-align: center;"> <p>M</p> </div> <div style="text-align: center;"> <p>O</p> </div> <div style="text-align: center;"> <p>P</p> </div> <div style="text-align: center;"> <p>R</p> </div> <div style="text-align: center;"> <p>S</p> </div> <div style="text-align: center;"> <p>T</p> </div> <div style="text-align: center;"> <p>V</p> </div> <div style="text-align: center;"> <p>W</p> </div> </div>

General ISO Turning
Technical information

Steadyline®

MDT

Mini-Shaft™

Grooving

Parting-off

X4

Adapters
Clamping units

Accessories and
Spare parts

Workpiece
materials

General ISO Turning
Technical information

Steadyline®

MDT

Mini-Shaft™

Grooving

Parting-off

X4

Adapters
Clamping units

Accessories and
Spare parts

Workpiece
materials

6. Tool type

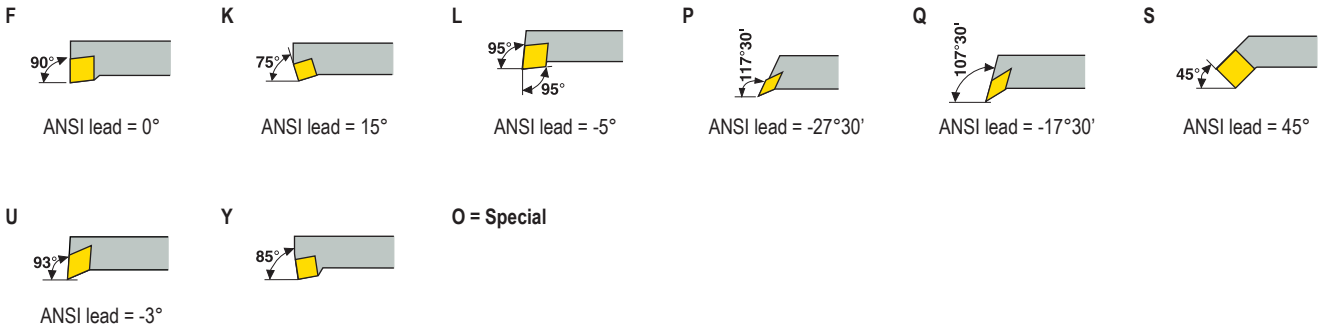

7. Insert side clearance angle

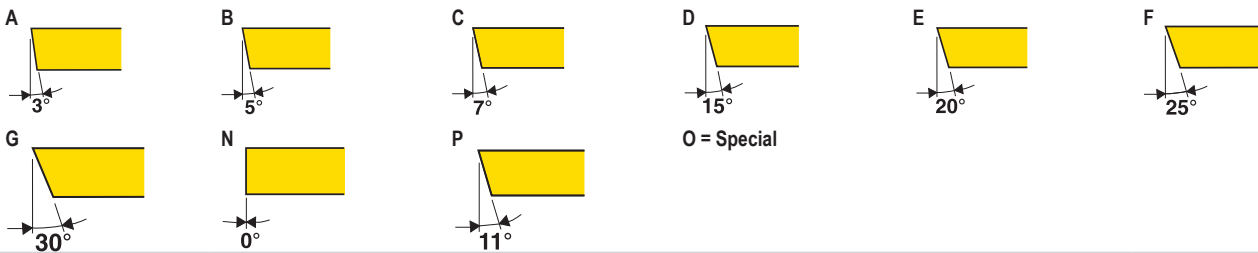

8. Cutting direction

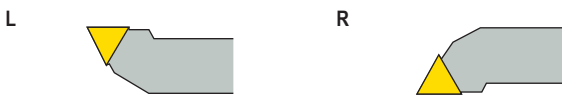

9. Insert size I.C.

Number of eights of I.C.

Cartridges – Inch (ANSI)

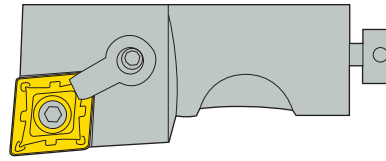

M	C	L	N	R	- 16	C	A	- 12
1	2	3	4	5	6	7	8	9

1. Insert clamping

D	P	M	S	C	T
Clamp/inserts with centre hole	Pin/Wedge or Lever	Pin/Clamp	Screw	Clamp	Tapered stem (Tee-lock)

1. Insert shape

A	B	C	D	E	H	K	L
M	O	P	R	S	T	V	W

3. Tool type

A	B	D	F	G	H	J	K
ANSI lead = 0°	ANSI lead = 15°	ANSI lead = 45°	ANSI lead = 0°	ANSI lead = 0°		ANSI lead = -3°	ANSI lead = 15°
L	N	P	R	S	T	V	
ANSI lead = -5°	ANSI lead = 27°30'	ANSI lead = -27°30'	ANSI lead = 15°	ANSI lead = 45°	ANSI lead = 30°	ANSI lead = 17°30'	

General ISO Turning
Technical information

Steadyline®

MDT

Mini-Shaft™

Grooving

Parting-off

X4

Adapters
Clamping units

Accessories and
Spare parts

Workpiece
materials

General ISO Turning
Technical information

4. Insert side clearance angle

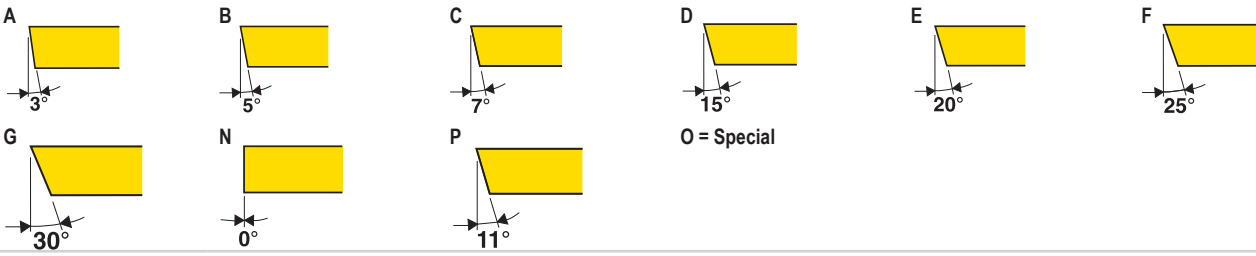

Steadyline®

5. Cutting direction

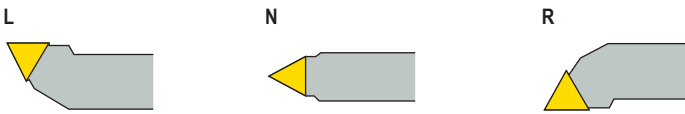

MDT

6. Cartridge cutting height

A Type = Length of cutting edge in millimeters
W, X & Z Type = Height in thousandths of an inch rounded (2) places

7. Thickness

C = Indicates cartridge

Mini-Shaft™

8. Cartridge type

A = Metric cartridge/metric components-metric hex wrench
W = Metric cartridge/metric components-Inch hex wrench
X = 90° mount cartridge
Z = Mini-cartridge

9. Insert type

A Type = Length of cutting edge in millimeters
W, X & Z Type = Insert I.C. in eighths of an inch
...JET = Jetstream Tooling®

Grooving

Parting-off

X4



Adapters
Clamping units

Accessories and
Spare parts

Workpiece
materials

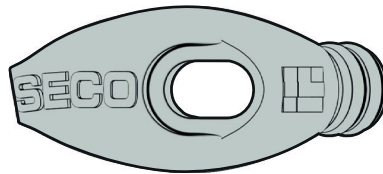
Coolant clamps for toolholders and modular turning heads

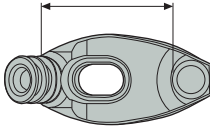
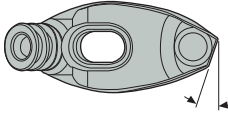

1. Coolant clamp type	2. Clamping length
CN = Coolant clamp for negative inserts CP = Coolant clamp for screw clamped inserts CX = Coolant clamp for custom clamping	 <p>14 = 14 mm / 0.550 inch 17 = 17 mm / 0.669 inch 21 = 21 mm / 0.827 inch</p>
3. Hole diameter	4. Outlet angle
U = 1,6 mm / 0.063 inch L = 2,2 mm / 0.085 inch X = Custom	 <p>00 = 0° 10 = 10° 20 = 20°</p>
5. Coolant clamp application type	6. Number of holes
F = Fine R = Roughing S = Standard X = Custom	0, 1, 2 etc.
7. Orientation of outlet face	
R = Right  L = Left  <p>Otherwise neutral</p>	

General ISO Turning
Technical information

Steadyline®

MDT

Mini-Shaft™

Grooving

Parting-off

X4

Adapters
Clamping units

Accessories and
Spare parts

Workpiece
materials

Insert series, Extract from ISO 1832 – Metric (ISO)

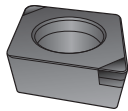
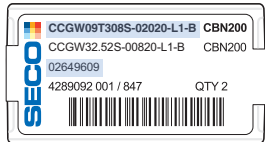
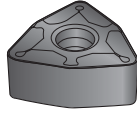
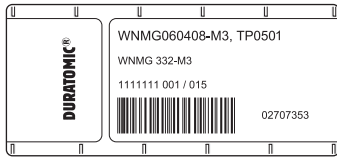

1. Insert shape

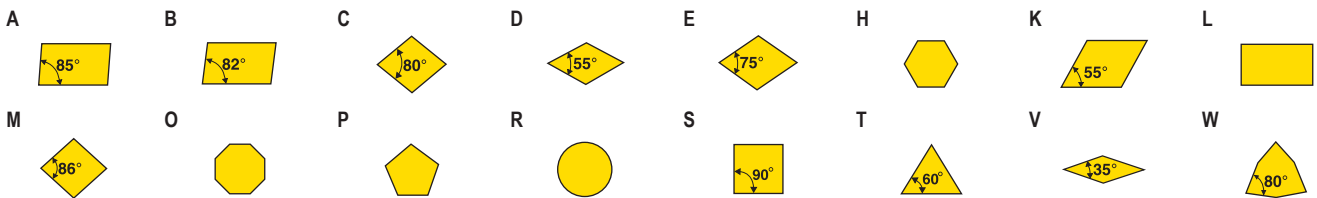

2. Insert side clearance angle

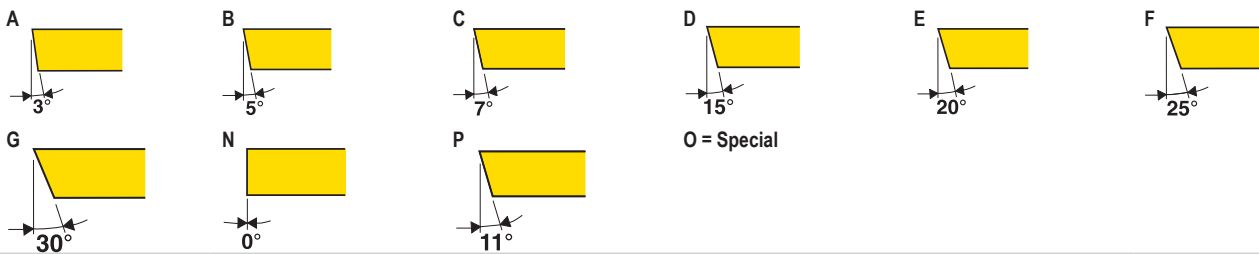

General ISO Turning
Technical information

Steadyline®

MDT

Mini-Shaft™

Grooving

Parting-off

X4

Adapters
Clamping units

Accessories and
Spare parts

Workpiece
materials

3. Tolerances																	
Tolerance class	Tolerances: mm/Inch				For IC, dimension in mm/Inch												
					3,18*	3,97	4,06	4,76	6,35	9,53	12,70	15,88	19,05	20,00	25,40	31,750	38,10
	S mm	IC mm	S Inch	IC Inch	0.125			0.187	0.250	0.375	0.500	0.625	0.750		1.000	1.250	1.500
A	0,025	0,025	0.0010	0.0010	•			•	•	•	•	•	•	•	•	•	•
C	0,025	0,025	0.0010	0.0010	•	•	•	•	•	•	•	•	•	•	•	•	•
E	0,025	0,025	0.0010	0.0010	•			•	•	•	•	•	•	•	•	•	•
F	0,025	0,013	0.0010	0.0005	•			•	•	•	•	•	•	•	•	•	•
G	0,050*	0,025	0.0020	0.0010	•			•	•								
	0,130	0,025	0.0051	0.0010						•	•	•	•	•	•	•	•
H	0,025	0,013	0.0010	0.0005	•			•	•	•	•	•	•	•	•	•	•
J	0,025	0,050	0.0010	0.0020	•			•	•								
	0,025	0,080	0.0010	0.0031							•						
	0,025	0,100	0.0010	0.0039								•	•	•			
	0,025	0,130	0.0010	0.0051											•		
	0,025	0,150	0.0010	0.0059												•	•
K	0,025	0,050	0.0010	0.0020	•			•	•								
	0,025	0,080	0.0010	0.0031							•						
	0,025	0,100	0.0010	0.0039								•	•	•			
	0,025	0,130	0.0010	0.0051											•		
	0,025	0,150	0.0010	0.0059												•	•
M	0,050*	0,050	0.0020	0.0020	•			•	•								
	0,130	0,050	0.0051	0.0020						•							
	0,130	0,080	0.0051	0.0031							•						
	0,130	0,100	0.0051	0.0039								•	•	•			
	0,130	0,130	0.0051	0.0051											•		
	0,130	0,150	0.0051	0.0059												•	•
U	0,050*	0,080	0.0020	0.0031	•			•	•								
	0,130	0,080	0.0051	0.0031						•							
	0,130	0,130	0.0051	0.0051							•						
	0,130	0,180	0.0051	0.0071								•	•	•			
	0,130	0,250	0.0051	0.0098											•	•	•

* Not ISO

4. Fixing and/or chipbreaker									
A	B	G	M	N	R				
T	U	W	X = Special						

5. Cutting edge length								
A, B, K	C, D, E, M, V	H, O, P	L	R	S	T	W	

6. Thickness			
			01 = 1,59 mm / 0.063 inch T1 = 1,98 mm / 0.078 inch 02 = 2,38 mm / 0.094 inch 03 = 3,18 mm / 0.125 inch
			T3 = 3,97 mm / 0.156 inch 04 = 4,76 mm / 0.187 inch 05 = 5,56 mm / 0.219 inch 06 = 6,35 mm / 0.250 inch
			07 = 7,94 mm / 0.313 inch 08 = 8,00 mm / 0.315 inch 09 = 9,52 mm / 0.375 inch

General ISO Turning
Technical information

Steadyline®

MDT

Mini-Shaft™

Grooving

Parting-off

X4

Adapters
Clamping units

Accessories and
Spare parts

Workpiece
materials

General ISO Turning
Technical information

Steadyline®

MDT

Mini-Shaft™

Grooving

Parting-off

X4

Adapters
Clamping units

Accessories and
Spare parts

Workpiece
materials

7. Corner configuration

nose radius	ISO Code No.	Decimal value	ANSI Code No.	Decimal value "	Fractional value
	M0	Round	00	Round	Round
	00	0,04 mm	X0	0.0015"	1/(64x10)
	01	0,1 mm	0 (0,25)	0.004"	1/(64x4)
	02	0,2 mm	0,5	0.008"	1/(64x2)
	04	0,4 mm	1	0.016"	1/64
	06	0,6 mm	1,5	0.020"	1/48
	08	0,8 mm	2	0.031"	1/32
	10	1,0 mm	2,5	0.040"	1/24
	12	1,2 mm	3	0.047"	3/64
	16	1,6 mm	4	0.062"	1/16
	20	0,8 mm	5	0.078"	5/64
	24	2,4 mm	6	0.094"	3/32
	28	2,8 mm	7	0.109"	7/64
	32	3,2 mm	8	0.125"	1/8
	40	4,0 mm	10	0.156"	5/32

8. Cutting edge condition



9. Cutting direction



10. Internal designation

e.g. chipbreaker designation
F = Finishing
M = Medium
R = Roughing

e.g. edge designation
e.g. 01020 = 0,1 mm x 20°

Not mandatory information

11. Manufacturers option

Tip sizes:
L0
L1
L2
LF = full-face insert (sintered layer)

Not mandatory information

12. Internal designation

Turning
e.g. chipbreaker designation
F = Finishing
M = Medium
R = Roughing
WZ = Wiper (PCBN)
etc.

Not mandatory information

13. No. of tips

B = 2
C = 3
D = 4
U = 4 (double sided)
V = 6 (double sided)

Not mandatory information

Insert series, Extract from ANSI B212 – Inch (ANSI)

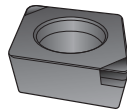
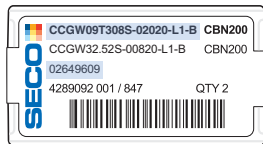
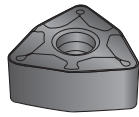
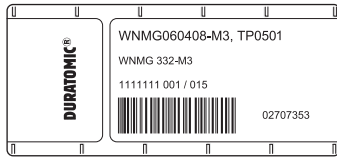

1. Insert shape

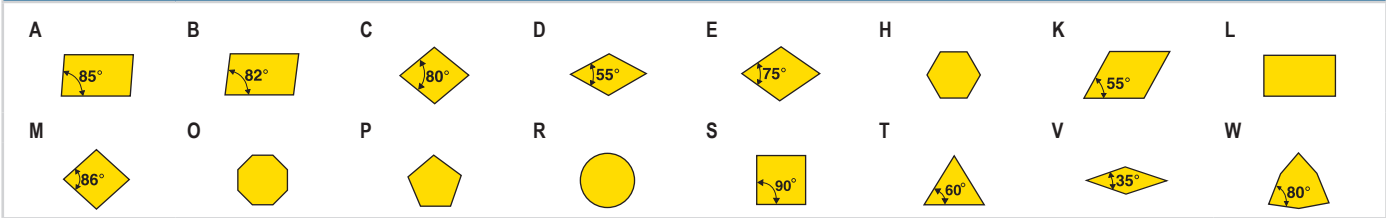

2. Insert side clearance angle

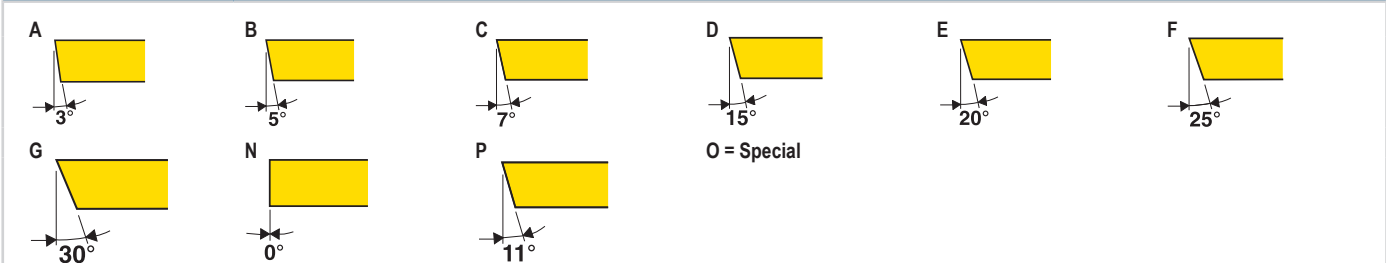

General ISO Turning
Technical information

Steadyline®

MDT

Mini-Shaft™

Grooving

Parting-off

X4

Adapters
Clamping units

Accessories and
Spare parts

Workpiece
materials

General ISO Turning
Technical information

Steadyline®

MDT

Mini-Shaft™

Grooving

Parting-off

X4

Adapters
Clamping units

Accessories and
Spare parts

Workpiece
materials

3. Tolerances

Tolerance class	Tolerances: mm/In				For IC, dimension in mm/Inch													
					3,18*	3,97	4,06	4,76	6,35	9,53	12,70	15,88	19,05	20,00	25,40	31,75	38,10	
	S mm	IC mm	S Inch	IC Inch	0,125			0,187	0,250	0,375	0,500	0,625	0,750		1,000	1,250	1,500	
A	0,025	0,025	0.0010	0.0010	•			•	•	•	•	•	•	•	•	•	•	•
C	0,025	0,025	0.0010	0.0010	•	•	•	•	•	•	•	•	•	•	•	•	•	•
E	0,025	0,025	0.0010	0.0010	•			•	•	•	•	•	•	•	•	•	•	•
F	0,025	0,013	0.0010	0.0005	•			•	•	•	•	•	•	•	•	•	•	•
G	0,050*	0,025	0.0020	0.0010	•			•	•									
	0,130	0,025	0.0051	0.0010						•	•	•	•	•	•	•	•	•
H	0,025	0,013	0.0010	0.0005	•			•	•	•	•	•	•	•	•	•	•	•
J	0,025	0,050	0.0010	0.0020	•			•	•	•								
	0,025	0,080	0.0010	0.0031							•							
	0,025	0,100	0.0010	0.0039								•	•	•				
	0,025	0,130	0.0010	0.0051											•			
K	0,025	0,050	0.0010	0.0020	•			•	•	•								
	0,025	0,080	0.0010	0.0031							•							
	0,025	0,100	0.0010	0.0039								•	•	•				
	0,025	0,130	0.0010	0.0051											•			
M	0,025	0,050	0.0010	0.0020				•	•	•								
	0,130	0,050	0.0051	0.0020	•					•								
	0,130	0,080	0.0051	0.0031							•							
	0,130	0,100	0.0051	0.0039								•	•	•				
	0,130	0,130	0.0051	0.0051											•			
U	0,050*	0,080	0.0020	0.0031	•			•	•									
	0,130	0,080	0.0051	0.0031						•								
	0,130	0,130	0.0051	0.0051							•							
	0,130	0,180	0.0051	0.0071								•	•	•				
	0,130	0,250	0.0051	0.0098											•	•	•	•

* Not ISO

4. Fixing and/or chipbreaker

A	B	G	M	N	R
T	U	W	X = Special		

5. Size

For equal sided inserts I.C. in 1/8 ths of an inch

1/8 = 1	1/2 = 4
5/32 = 1.2	5/8 = 5
3/16 = 1.5	3/4 = 6
7/32 = 1.8	7/8 = 7
1/4 = 2	1 = 8
5/16 = 2.5	1 1/4 = 10
3/8 = 3	

Rectangle and parallelogram inserts require two digits:

1st Digit – Number of 1/8ths in width

2nd Digit – Number of 1/4ths in length

6. Thickness

Number of 1/32nds on inserts less than 1/4" I.C.

Number of 1/16ths on inserts 1/4" I.C. and over.

7. Corner configuration

nose radius



ANSI Code No.	Decimal value "	Fractional value	ISO Code No.	Decimal value
00	Round	Round	MO	Round
X0	0.0015"	1/(64x10)	00	0,04 mm
0 (0.25)	0.004"	1/(64x4)	01	0,1 mm
0.5	0.008"	1/(64x2)	02	0,2 mm
1	0.016"	1/64	04	0,4 mm
1.5	0.020"	1/48	06	0,6 mm
2	0.031"	1/32	08	0,8 mm
2.5	0.040"	1/24	10	1,0 mm
3	0.047"	3/64	12	1,2 mm
4	0.062"	1/16	16	1,6 mm
5	0.078"	5/64	20	0,8 mm
6	0.094"	3/32	24	2,4 mm
7	0.109"	7/64	28	2,8 mm
8	0.125"	1/8	32	3,2 mm
10	0.156"	5/32	40	4,0 mm

8. Cutting edge condition

F



E



T



S

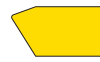

W = High feed inserts
Not mandatory information

9. Manufacturers option

e.g. chipbreaker designation
 F = Finishing
 M = Medium
 R = Roughing
 1 = For low feed rates and easy conditions
 2 = For high feed rates and rough conditions

General ISO Turning
Technical information

Steadyline®

MDT

Mini-Shaft™

Grooving

Parting-off

X4

Adapters
Clamping units

Accessories and
Spare parts

Workpiece
materials

Introduction to choose product

To choose turning products can be quite a comprehensive task if every single detail should be taken into account. Since we have chosen turning the sought shape is basically well-turned or using the technical term a rotational symmetric component.

The present section will focus on coated cemented carbide applications and there is a separate section for advanced materials applications such as PCBN, PCD and Ceramics, but there are of course topics general for turning.

First steps – the Secolor® principle

Seco has a long tradition to work in accordance with the principle attributed to Albert Einstein in the 1950's: "Everything should be made as simple as possible, but not simpler". However, it should always be easy to be successful, but the more detailed the requirements, the more details need to be considered.

The intention of this "Choose Product" section is to show how easy the choice of a product can be and the starting point is how Seco always intends to make turning easy. However, depending on your insight and your actual conditions it is recommended you jump in the process to fit your specific needs.

One first point is considering the purpose of the turning operation, and that most often starts with considering the turning insert, which can be studied in a lot of detail, or as simple as possible to ensure a successful outcome.

Secolor® is a simple system used to present recommended application areas of a specific turning insert. It is based on a matrix with eighteen squares symbolizing workpiece materials under different states of machining, indicating the main application areas by black dots and alternative application areas as circles. It should also only be understood as a starting point as most skilled professional in machining in general and turning in particular do.

In the example below, the product is recommended for medium and rough turning of steel workpieces as it's main application area, and in machining of cast iron components as an alternative solution.

The objective is to eliminate waste, and this will become clearer as we go forward.

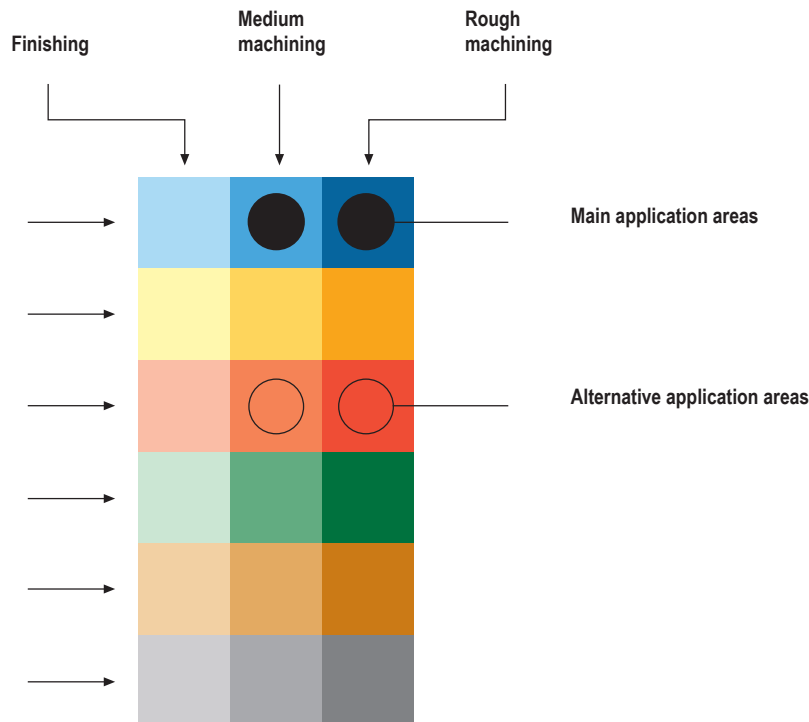

First steps – the insert shape & size

To choose turning products, one also needs to consider the purpose of the turning operation with its conditions, requirements and the degrees of freedom.

Now, the key points are

- How much stock is to be taken away?
- What does the pre-machined component look like?
- What does the drawing specify about the finished component?
- And, last but not the least – What else needs to be taken into account?

Standards created in the 70's define the insert by using the first letter of its shape as the first letter of the nomenclature, see the first letter of the code key below. Note that not all shapes are commonly used in turning.

1. Insert shape





When choosing a common shape, for example a "C" shape with the 80° corner (see above), the stock on a component possible to remove is then depending on the size of the insert and its maximum depth of cut according to the table below.

Insert shape	Insert size	Maximum depth of cut a_p (mm)														
		2	4	6	8	10	12	14	16	18	20	22	24	26	28	
C 	04	—														
	06	—	—													
	09	—	—	—												
	12	—	—	—	—											
	16	—	—	—	—	—										
	19	—	—	—	—	—	—									
	25	—	—	—	—	—	—	—								

In the above table the size of the inserts is indicated. If for example the stock is 4 mm and the idea is to cut it away in one (1) pass, it is recommended to use a "12" size "C" insert or bigger. On the next page a more complete set of relevant turning inserts are shown with their respective recommended ranges for depths of cut.

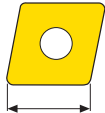
Insert shape and size

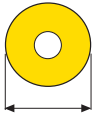
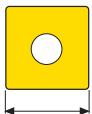
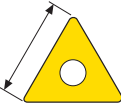
The application often determines what insert shape and size should be utilized

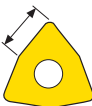
Insert shape	Insert size	Maximum depth of cut a_p (mm)														
		2	4	6	8	10	12	14	16	18	20	22	24	26	28	
C 	04	—														
	06	—	—													
	09	—	—	—												
	12	—	—	—	—											
	16	—	—	—	—	—										
	19	—	—	—	—	—	—									
	25	—	—	—	—	—	—	—								
D 	07	—	—													
	11	—	—	—												
	15	—	—	—	—											
R 	06	—	—													
	08	—	—	—												
	10	—	—	—	—											
	12	—	—	—	—	—										
	15	—	—	—	—	—	—									
	16	—	—	—	—	—	—	—								
	19	—	—	—	—	—	—	—								
	20	—	—	—	—	—	—	—	—							
	25	—	—	—	—	—	—	—	—	—						
32	—	—	—	—	—	—	—	—	—	—						
S 	09	—	—													
	12	—	—	—												
	15	—	—	—	—											
	19	—	—	—	—	—										
	25	—	—	—	—	—	—									
	31	—	—	—	—	—	—	—								
	38	—	—	—	—	—	—	—	—							
T 	06	—														
	11	—	—													
	16	—	—	—												
	22	—	—	—	—											
	27	—	—	—	—	—										
	33	—	—	—	—	—	—									
V 	11	—	—													
	16	—	—	—												
	22	—	—	—	—											
W 	06	—	—													
	08	—	—	—												

First steps – from insert to toolholder

It is obvious from the earlier table that for the same stock removal, there are several insert options based on their shapes and sizes.

Just briefly, look at the insert sketches below.

An "R" shape insert has no corner however has big strong radius, an "S" shape insert has strong and equal corners, a "C" shape insert has a corner that can make 90° shoulders, and a "V" shape insert has a weaker corner but deep reach for deep profiles.

Now, the key points are

- How much stock is to be taken away?
- What does the pre-machined component look like?
- What does the drawing specify about the finished component?
- And, last but not the least- What else needs to be considered?

Look at the application sketches below, considering the two questions where to start and where to end. A rough first conclusion starting from below,

the "R" shape insert is perfect for round profiles,

the "S" shape insert is perfect for simple surfaces,

the "C" shape insert is perfect for varying surfaces and

the "V" shape insert has a weaker corner but deep reach for deep profiles

The chart below explains the different insert shapes with their relative strength, number of edges, operational freedom, and accessibility.

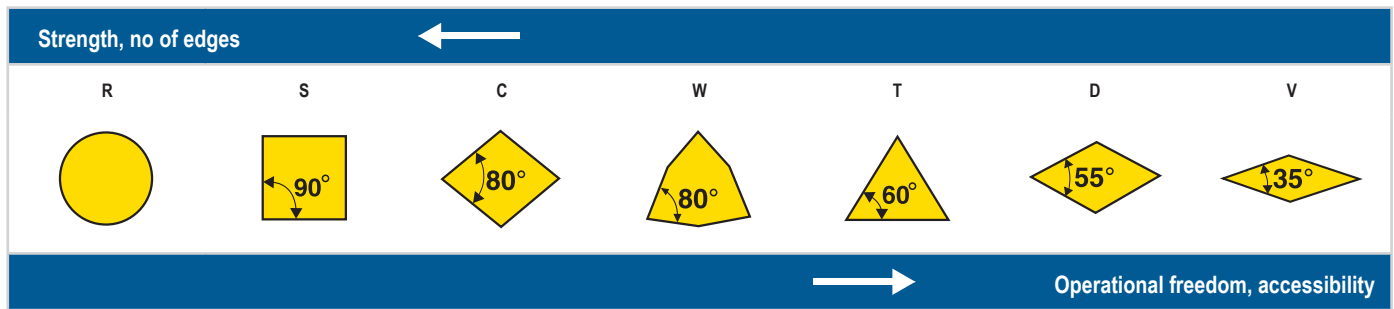

A second conclusion indicates the toolholder's importance to achieve the needed final part. The toolholder enables an insert to achieve a specific surface or profile. After focusing on the aspects of the toolholder there will be a comprehensive list of application toolholder guidance.

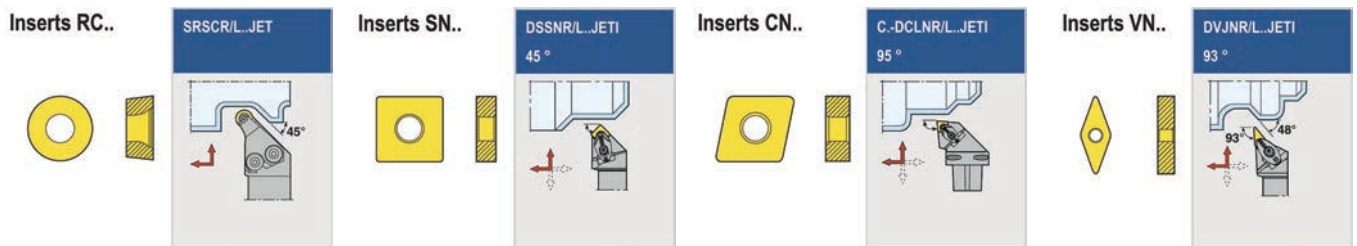

General ISO Turning
Technical information

Steadyline®

MDT

Mini-Shaft™

Grooving

Parting-off

X4

Adapters
Clamping units

Accessories and
Spare parts

Workpiece
materials

First steps – the toolholder

1. Insert clamping

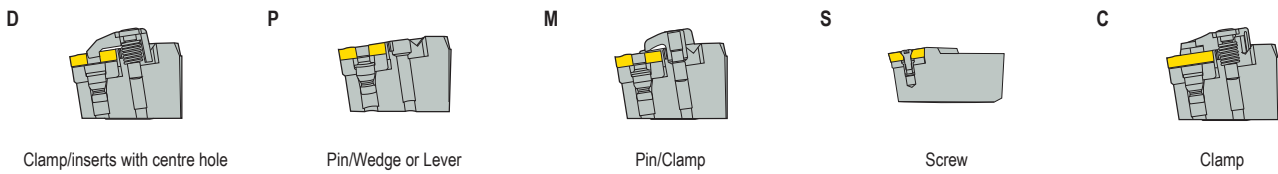

In the pictures above a range of common toolholder solutions for insert clamping where Seco has chosen to mainly offer "C", "D" and "S", but there are a number of options. On this page there will however be brief suggestions how to handle options with brief "pros" and "cons" on each, but it will be fully covered later in the Product Detail Guidance sections in the catalogue.

These letters denote the clamping style on a toolholder, and should not be mixed up with the earlier mentioned letters for the insert nomenclature.

Seco clamping designs can be summarized as follows

"C" clamping

– extremely rigid top clamp with pressure plate suited especially for advanced material inserts but also a number of cemented carbide inserts.

"D" clamping

– stable and rigid top clamp also re-appearing in the form of the Jetstream Tooling® JETI coolant clamp for for most applications with double sided inserts with a through hole.

"M" clamping

– classic double security clamping with eccentric pin locking in hole, and complimented by a top clamp, still common in some areas for double sided inserts.

"P" clamping

– a group of several clamping designs avoiding interference in the chip space above double sided inserts with hole in different ways. It consists of, for example, toggle lever-clamping, wedge-clamping and excenter-pin clamping.

"S" clamping

– the most straight forward proven solution for screw-hole, often single sided inserts without interference in the chip space above the insert where the screw needs to be removed to exchange the insert.

First steps – code for toolholder application

3. Tool type

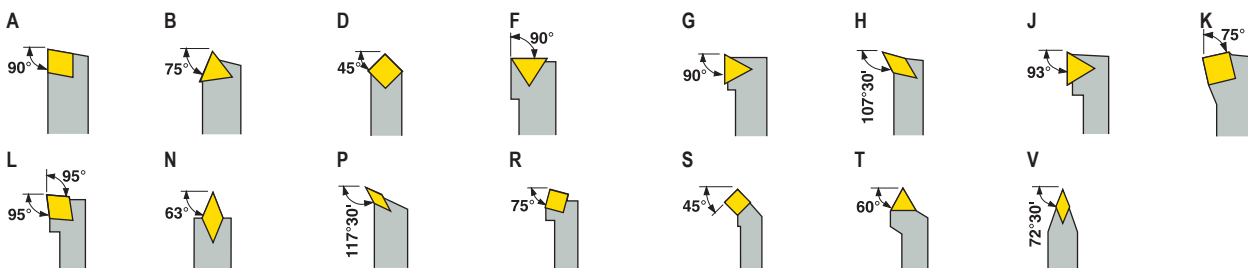

Now as seen earlier there are several demands and requirements on the generation of surfaces in turning. The above sketches on the codes for tool types give hint on the options connected to the position "3" in the below code key for toolholders.



D	W	L	N	R	25	25	X	06	JETI
1	2	3	4	5	6	7	8	9	10

The options so far actually connect to the code keys of toolholders where

"Position 1" corresponds to the "Clamping design"

"Position 2" corresponds to the "Insert shape"

"Position 3" corresponds to the "Tool type"

Please go back to the earlier comprehensive Code Key pages for detailed descriptions.

First steps – toolholder to machine

There are several connections to a standardized machine connection and this will be covered briefly here to connect to the code keys.

Please refer back to the earlier comprehensive Code Keys pages for detailed descriptions.

The most common classic toolholder connection for external application is a square connection and most often fixed with a set of screws. In the code key to the right that connection size is indicated with "2525" in "position 6" and "position 7". In position 8, the length code "X" indicates a non-standard length, and this will be found in the product pages.

Note ANSI shank code relates to how many 16th of an inch, further detailed in the ANSI [inch] Code Key.

Going to internal applications the toolholder connections are similar and fixed with screws but in the standard the connection size is indicated in "position 2" where "20" in the example to the right means 20 mm. The length is represented in "position 3" in the letter "Q" corresponding to 180 mm (see the Code Key).

Note that a ANSI shank code A20-... corresponds to the number of 16th of an inch i.e. significantly bigger shank than the metric version. 20 on an ANSI description would represent 1.250".

However more modern machine connection standards such as Seco-Capto™ to the right, Seco-Capto™ uses the logic to start with the connections size i.e. the connection size "C4" in "position 1" in the code key to the right. The functional width and length are found in that order in "position 7" and "position 8" always measured in mm.

There are a number of interesting modular solutions available such as the GL-connection especially for stabilized internal applications and QC-connection for external applications in small part machining, but those are connected to machines with a back-end according to above e.g. Seco-Capto™ or square shank.

Please go back to the earlier comprehensive Code Keys pages for detailed descriptions.

Seco-Capto™ – brief description

This, now standardized system, as per ISO26623 is a modular system for machines such as lathes introduced from the 1990's for fast and efficient change of holders and inserts summarized as "quick-change".

The main benefits are

- Increased total productivity from the faster tools changes
- High precision, rigid, self-centering connection due to the strong conical polygon giving repeatability within microns
- Increased productivity since no need for cutting data adjustments due to the stable connection
- Reduced inventory of holders in a workshop due to same precise standardized machine side connection
- Through coolant means no separate coolant handling



D	W	L	N	R	25	25	X	06	JETI
1	2	3	4	5	6	7	8	9	10



A	20	Q	-	P	W	L	N	R	06	R
1	2	3		4	5	6	7	8	9	10

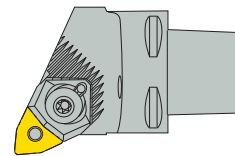

C4	-	P	W	L	N	R	-	27	050	-	06	-	
1		2	3	4	5	6		7	8		9		10

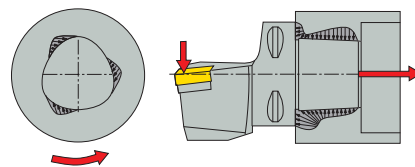

Seco Jetstream Tooling® – brief introduction

This revolutionary innovation delivers high pressure coolant jet precisely to cutting zone – available in all Seco turning product areas.

The General ISO Turning Jetstream Tooling® toolholder to the right indicates yet another revolution using the leading JETI-coolant clamp designs.

The main benefits with Seco Jetstream Tooling® are

- Tool life improvement due to the high-pressure jet lifting chips away from the rake face
- Improved chip control
- Increased tool life due to the precise and undisturbed coolant delivery even at low pressures in nearly all component materials



General ISO Turning
Technical information

Steadyline®

MDT

Mini-Shaft™

Grooving

Parting-off

X4

Adapters
Clamping units

Accessories and
Spare parts

Workpiece
materials

Application overview

The following Application overview pages will provide a good insight of the usage of toolholders and inserts from an application perspective. It should also be said and recommended to look into the Seco Suggest or explore the opportunities directly on www.secotools.com/suggest at any webbrowser.

QC Toolholders

Inserts CC..

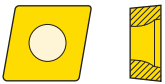

QC..-SCLCR/L..JET
95 °

page(s) 153

Inserts DC..

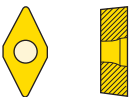

QC..-SDJCR/L..JET
93 °

page(s) 154

Inserts VB..

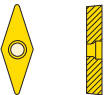

QC..-SVJBR/L..JET
93 °

page(s) 155

Inserts LC..

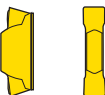

QC..-CFOR/L..RBJET
90 °

page(s) 156

Inserts 150.10..



QC..-R/L150.10..JETI

page(s) 157

General ISO Turning
Technical information

Inserts SnapTap threading

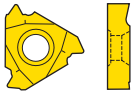

QC...PER/L...HDJET

page(s) 158

Steadyline®

Toolholders external, Seco-Capto™

Inserts CC..

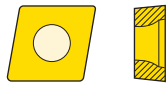

C.-DCLCR/L...JETI 95 °	C.-SCLCR/L...JET 95 °	C.-SCLCR/L 95 °	C.-SCMCN 95 °
page(s) 159, 160	page(s) 187, 188	page(s) 224, 225	page(s) 251

MDT

Mini-Shaft™

Inserts CN..



C.-DCLNR/L...JETI 95 °	C.-DCRNR/L...JETI 75 °	C.-PCLNR/L...JETL 95 °	C.-DCLNR/L 95 °	C.-DCMNN 95 °	C.-DCRNR/L 75 °
page(s) 161, 162	page(s) 163	page(s) 179, 180	page(s) 194, 195	page(s) 247	page(s) 196, 197

C.-DCKNR/L 75 °	C.-PCLNR/L 95 °
page(s) 192, 193	page(s) 217, 218

Grooving

Parting-off

X4

Inserts CN.N



**C.-CCLNR/L
95 °**

page(s) 236, 237

Adapters
Clamping units

Accessories and
Spare parts

Inserts DC..

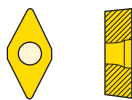

C.-DDJCR/L...JETI 93 °	C.-SDJCR/L...JET 93 °	C.-SDJCR/L 93 °	C.-SDNCN 62,5 °
page(s) 164	page(s) 189	page(s) 226	page(s) 227

Workpiece
materials

Inserts DN..

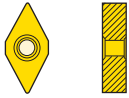

C.-DDJNR/L...JETI 93 °	C.-DDUNR/L...JETI 93 °	C.-PDJNR/L...JETL 93 °	C.-DDJNR/L 93 °	C.-DDMNL 93 °	C.-DDNNN 62,5 °
page(s) 165, 166	page(s) 167	page(s) 181, 182	page(s) 198, 199	page(s) 248	page(s) 200

C.-DDUNR/L 93 °
page(s) 201, 202

Inserts RC..



C.-SRSCR/L...JET	C.-SRDCN	C.-SRDCN...A	C.-SRSCR/L
page(s) 190	page(s) 252	page(s) 228, 229	page(s) 230, 231

Inserts RN..

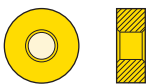

C.-DRSNR/L
page(s) 203

General ISO Turning
Technical information

Steadyline®

MDT

Mini-Shaft™

Grooving

Parting-off

X4

Adapters
Clamping units

Accessories and
Spare parts

Workpiece
materials

General ISO Turning
Technical information

Inserts RN.N



C.-CRSNR/L	C.-CRSNR/L-.C
page(s) 238, 239	page(s) 243

Steadyline®

Inserts SC..

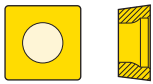

C.-SSRCR/L
75 °
page(s) N/A

MDT

Inserts SN..

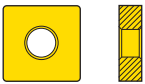

C.-DSSNR/L...JETI	C.-DSNR/L	C.-DSKNR/L	C.-DSDNN	C.-DSSNR/L
45 °	75 °	75 °	45 °	45 °
page(s) 168, 169	page(s) 207, 208	page(s) 206	page(s) 204, 205	page(s) 209, 210
C.-PSKNR/L	C.-PSNR/L	C.-PSDNN		
75 °	75 °	45 °		
page(s) 220	page(s) 221	page(s) 219		

Mini-Shaft™

Grooving

Parting-off

Inserts SN.N



C.-CSNR/L	C.-CSDNN
75 °	45 °
page(s) 241	page(s) 240

X4

Adapters
Clamping units

Inserts TN..



C.-DTJNR/L...JETI	C.-PTJNR/L...JETL	C.-DTJNR/L	C.-DTGNR/L	C.-DTFNR/L
93 °	93 °	93 °	90 °	90 °
page(s) 170	page(s) 183	page(s) 213	page(s) 212	page(s) 211

Accessories and
Spare parts

Workpiece
materials

Inserts TN.N



C.-CTJNR/L 93 °
page(s) 242

Inserts VB../VC..

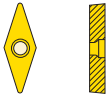

C.-DVJBR/L...JETI 93 °	C.-DVHBR/L...JETI 107,5 °	C.-DVVBN...JETI 72,5 °	C.-SVJBR/L...JET 93 °	C.-SVHBR/L 107,5 °	C.-SVJBR/L 93 °
page(s) 172, 173	page(s) 171	page(s) 176	page(s) 191	page(s) 232	page(s) 233, 234

C.-SVMBL 95 °	C.-SVVBN 72,5 °
page(s) 253	page(s) 235

Inserts VN..

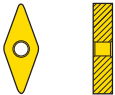

C.-DVJNR/L...JETI 93 °	C.-PVJNR/L...JETL 93 °	C.-DVJNR/L 93 °	C.-DVMNL 93 °
page(s) 174, 175	page(s) 184	page(s) 214	page(s) 249

Inserts WN..



C.-DWLNR/L...JETI 95 °	C.-PWLNR/L...JETL 95 °	C.-DWLNR/L 95 °	C.-PWLNN 95 °	C.-PWLNR/L 95 °
page(s) 177, 178	page(s) 185, 186	page(s) 215, 216	page(s) 250	page(s) 222, 223

General ISO Turning
Technical information

Steadyline®

MDT

Mini-Shaft™

Grooving

Parting-off

X4

Adapters
Clamping units

Accessories and
Spare parts

Workpiece
materials

Toolholders external, Seco-Capto™, cassettes

Inserts CN.N

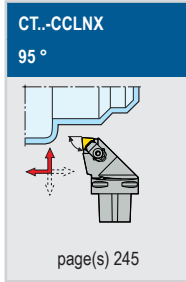

Inserts RN.N

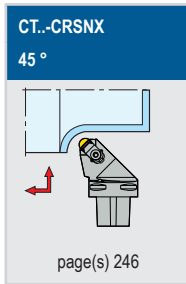

General ISO Turning
Technical information

Steadyline®

MDT

Mini-Shaft™

Grooving

Parting-off

X4

Adapters
Clamping units

Accessories and
Spare parts

Workpiece
materials

Toolholders external

Inserts CC..



DCLCR/L...JETI 95 °	SCLCR/L 95 °	SCACR/L 90 °	SCGCR/L 90 °	SCFCR/L 90 °	SCBCR/L 75 °
page(s) 255, 256, 257	page(s) 337, 338	page(s) 332	page(s) 335, 336	page(s) 334	page(s) 333
SCDCR/L 45 °	SCMCN 90 °	SCRCR/L 90 °			
page(s) 334	page(s) 339	page(s) 340			

Inserts CN..



DCLNR/L...JETI 95 °	DCBNR/L...JETI 75 °	DCLNR/L 95 °	PCLNR/L 95 °	DCBNR/L 75 °	PCBNR/L 75 °
page(s) 258, 259	page(s) 254	page(s) 282, 283, 284, 285	page(s) 314, 315	page(s) 278, 279	page(s) 313
DCKNR/L 75 °	MCKNR/L 90 °	MCLNR/L 90 °	MCMNN 90 °	MCRNR/L 90 °	
page(s) 280, 281	page(s) 367	page(s) 368	page(s) 369	page(s) 370	

Inserts CN.N



CCLNR/L 95 °	CCBNR/L 75 °	CCLNR/L-C 95 °
page(s) 392	page(s) 392	page(s) 393

Inserts DC..

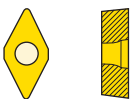

DDJCR/L...JETI 93 °	SDHCR/L 107,5 °	SDJCR/L 93 °	SDACR/L 90 °	SDNCN 62,5 °	SDPCN 90 °
page(s) 260, 261	page(s) 342	page(s) 343, 344, 345	page(s) 341	page(s) 346	page(s) 347

General ISO Turning
Technical information

Steadyline®

MDT

Mini-Shaft™

Grooving

Parting-off

X4

Adapters
Clamping units

Accessories and
Spare parts

Workpiece
materials

General ISO Turning
Technical information

Inserts DN..

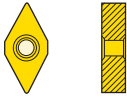

DDJNR/L...JETI 93 °	DDHNR/L 107,5 °	DDJNR/L 93 °	PDJNR/L 93 °	PDNNR/L 63 °	DDPNN 90 °
page(s) 262, 263, 264	page(s) 286	page(s) 287, 288	page(s) 316	page(s) 317	page(s) 290

Steadyline®

DDQNR/L 90 °	MDJNR/L 90 °
page(s) 291	page(s) 371

MDT

Inserts DN.A



DDJNR/L...-C 93 °	DDNN...-C 62,5 °
page(s) 289	page(s)

Mini-Shaft™

Grooving

Inserts DN.N



CDJNR/L 93 °	CDNNN 62,5 °
page(s) 394	page(s) 394

Parting-off

X4

Inserts LNMX19/30



CT-PLANR/L (175.32) 90 °	CT-PLFNR/L 90 °
page(s)	page(s)

Adapters
Clamping units

Accessories and
Spare parts

Workpiece
materials

Inserts RC..



SRSCR/L...JET	PRDCN	SRDCN	SRSCR/L	CRDCR/L..C	CRDCN...C
page(s) 276, 277	page(s) 318	page(s) 348, 349, 350	page(s) 352, 353	page(s) 395	page(s) 395
MRGOR/L 90 °	SRGCR/L 90 °	PROON 90 °			
page(s) 373	page(s) 351	page(s) 319			

Inserts RCG.

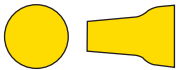

TRAOR/L	TRDON	TRGOR/L 90 °	TROON 90 °
page(s) 389, 390	page(s) 389	page(s) 391	page(s) 390

Inserts RN..

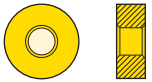

DRSNR/L	DRGNR/L 90 °	MRGNR/L 90 °
page(s) 293	page(s) 292	page(s) 372

Inserts RN.N



CRSNR/L	CRDNN	CRSNR/L..C	CRDNN..C	CRGNR/L 90 °
page(s) 398, 399	page(s) 396, 398, 399	page(s) 400	page(s) 400	page(s) 397

Inserts SC..

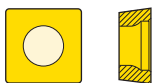

SSDCN 45 °	SSBCR/L 75 °
page(s) 354, 355	page(s) 356

- General ISO Turning Technical information
- Steadyline®
- MDT
- Mini-Shaft™
- Grooving
- Parting-off
- X4
- Adapters Clamping units
- Accessories and Spare parts
- Workpiece materials

General ISO Turning
Technical information

Inserts SN..

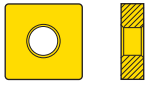

DSSNR/L...JETI 45 °	DSBNR/L 75 °	PSBNR/L 75 °	MSSNR/L 75 °	DSKNR/L 75 °	PSKNR/L 75 °
page(s) 265, 266	page(s) 294	page(s) 320, 321	page(s) 374	page(s) 297, 298	page(s) 322
MSRNR/L 75 °	DSDNN 45 °	DSSNR/L 45 °	PSDNN 45 °	PSSNR/L 45 °	MSDNN 90 °
page(s) 376, 377	page(s) 295, 296	page(s) 299, 300, 301	page(s) 322	page(s) 323	page(s) 375

Steadyline®

MDT

Inserts SN.A



DSBNR/L...C 75 °	DSSNR/L...C 45 °
page(s) 409	page(s) 409

Mini-Shaft™

Grooving

Inserts SN.N



CSBNR/L 75 °	CSRNR/L 75 °	CSKNR/L 75 °	CSSNR/L 45 °	CSDNN 45 °
page(s) 401	page(s) 401	page(s) 402	page(s) 404	page(s) 402, 403

Parting-off

Inserts TC..

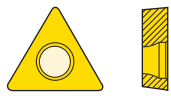

STJCR/L 93 °	STGCR/L 90 °	STFCR/L 90 °
page(s) 360	page(s) 357, 358, 359	page(s) 357, 358

X4

Adapters
Clamping units

Accessories and
Spare parts

Workpiece
materials

Inserts TN..



DTJNR/L...JETI 93 ° page(s) 267, 268	PTJNR/L 93 ° page(s) 328, 329	DTGNR/L 90 ° page(s) 304, 305	PTGNR/L 90 ° page(s) 326, 327	DTFNR/L 90 ° page(s) 302, 303	PTBNR/L 75 ° page(s) 325
PTNNR/L 63 ° page(s) 325	PTTNR/L 60 ° page(s) 330	DTJNR/L 90 ° page(s) 306	MTCNN 90 ° page(s) 378	MTENNS 90 ° page(s) 379	MTFNR/L 90 ° page(s) 380
MTGNR/L 90 ° page(s) 381	MTLNR/L 90 ° page(s) 383	MTJNR/LS 90 ° page(s) 382			

Inserts TN.N



CTJNR/L 93 ° page(s) 406, 407	CTGNR/L...PL 90 ° page(s) 405	CTFNR/L 91 ° page(s) 406, 407
--	--	--

Inserts VB/VC..

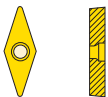

DVJBR/L...JETI 93 ° page(s) 269, 270	SVLBR/L 95 ° page(s) 363, 364	SVJBR/L 93 ° page(s) 361	SVJCR/L 93 ° page(s) 362	SVABR/L 90 ° page(s) 362	SVVBN 72,5 ° page(s) 364, 365
---	--	---	---	---	--

Inserts WC..



SWLCR/L 95 ° page(s) 366

General ISO Turning
Technical information

Steadyline®

MDT

Mini-Shaft™

Grooving

Parting-off

X4

Adapters
Clamping units

Accessories and
Spare parts

Workpiece
materials

General ISO Turning
Technical information

Inserts VN..

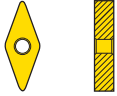

DVJNR/L...JETI 93 °	DVPCR/L 117,5 °	DVJNR/L 93 °	MVJNR/L 90 °	MVLNR/L 90 °	MVTNR/L 90 °
page(s) 271, 272	page(s) 309, 310	page(s) 307, 308	page(s) 384	page(s) 385	page(s) 386

Steadyline®

Inserts WN..



DWLR/L...JETI 95 °	DWLR/L 95 °	PWLR/L 95 °	MWLR/L 95 °
page(s) 273, 274, 275	page(s) 311, 312	page(s) 331	page(s) 387, 388

MDT

Mini-Shaft™

Inserts VN.A



CVVNN 72,5 °
page(s) 408

Grooving

Parting-off

Inserts WN.A



DWLR/L...C 95 °
page(s) 410

X4

Adapters
Clamping units

Accessories and
Spare parts

Workpiece
materials

Toolholders internal, Seco-Capto™

Inserts CC..



C.-SCLCR/L
95 °

page(s) 420, 421

Inserts CN..



C.-PCLNR/L
95 °

page(s) 411, 412

Inserts DC..

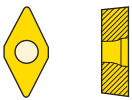

<p>C.-SDUCR/L 93 °</p> <p>page(s) 424, 425</p>	<p>C.-SDUCR/L..X 93 °</p> <p>page(s) 426</p>
---	---

Inserts DN..

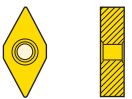

<p>C.-PDUNR/L..-15 93 °</p> <p>page(s) 413, 414</p>	<p>C.-PDQNR/L 107,5 °</p> <p>page(s) 422, 423</p>	<p>C.-SDQNR/L 107,5 °</p> <p>page(s) 422, 423</p>	<p>C4-S/PDUNR/L..-11 93 °</p> <p>page(s) 427, 428</p>	<p>C5-S/PDUNR/L..-11 93 °</p> <p>page(s) 427, 428</p>
--	--	--	--	--

Inserts SN../CN..



<p>C.-MSKNR/L - PCLNR/L 75 °</p> <p>page(s) 434</p>	<p>C.-DSKNR/L - PCLNR/L 75 °</p> <p>page(s) 433</p>
--	--

General ISO Turning
Technical information

Inserts TC..

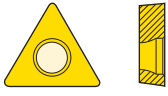

C.-STFCR/L
90 °

page(s) 429

Steadyline®

Inserts TN..

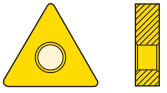

C.-PTFNR/L..-W
90 °

page(s) 415

MDT

Inserts TN.N



C.-CTUNR/L
93 °

page(s) 432

Mini-Shaft™

Grooving

Inserts VB../VC..

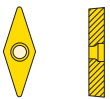

C.-SVQBR/L
107,5 °

page(s) 430, 431

Parting-off

X4

Inserts VN..

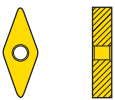

<p>C.-PVUNR/L 93 °</p> <p>page(s) 416, 417</p>	<p>C.-MVUNR/L 93 °</p> <p>page(s) 416, 417</p>
---	---

Adapters
Clamping units

Accessories and
Spare parts

Inserts WN..



C.-PWLNR/L
95 °

page(s) 418, 419

Workpiece
materials

Toolholders internal

Inserts CC..



A..SCLCR/L06 95 °	A..SCLCR/L09 95 °	A..SCFCR/L 90 °	E..SCFCR/L 90 °
page(s)	page(s)	page(s) 450, 451, 453	page(s) 452

Inserts CD..

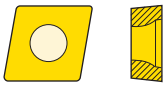

A..SCFDR/L 90 °	A..SCLDR/L 95 °	xx-SCLDR 90 °
page(s) 457	page(s) 457	page(s) 458

Inserts CN..

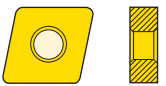

A..PCLNR/L 95 °	S..PCLNR/L 95 °	S..MCLNR/L 95 °	A..MCLNR/L 90 °
page(s) 437, 438	page(s) 439	page(s) 479, 481	page(s) 480

Inserts CN.N



S..CCLNR/L 95 °
page(s) 496

Inserts DC..



A..SDUCR/L 93 °	A..SDQCR/L 107,5 °	S..SDQCR/L 90 °
page(s) 463, 464, 466	page(s) 459, 466	page(s) 460

General ISO Turning
Technical information

Inserts DN..

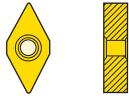

A..SDUNR/L 93 ° page(s) 465, 467	A..PDQNR/L 107,5 ° page(s) 461, 462	A..SDQNR/L 107,5 ° page(s) 461, 462	A..PDYNR/L 95 ° page(s) 468	A..SDYNR/L 95 ° page(s) 468	A..PDUNR/L 93 ° page(s) 440, 441
---	--	--	--	--	---

Steadyline®

S..PDUNR/L 93 ° page(s) 442	A..MDUNR/L 90 ° page(s) 482	S..MDUNR/L 90 ° page(s) 483
--	--	--

MDT

Inserts DNMA



A..DDUNR/L..-C 93 ° page(s) 500
--

Mini-Shaft™

Grooving

Inserts RN.N



S..CRSNR/L page(s) 497

Parting-off

X4

Inserts SN..

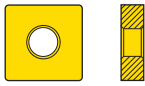

S..MSKNR/L 75 ° page(s) 484	S..PSKNR/L 75 ° page(s) 443
--	--

Adapters
Clamping units

Accessories and
Spare parts

Inserts SN.N



S..CSKNR/L 75 ° page(s) 498
--

Workpiece
materials

Inserts TC..

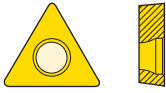

A..-STFCR/L 90 °	A..-STUCR/L 90 °	E..-STFCR/L 90 °
page(s) 469, 470, 471	page(s) 471	page(s) 472

Inserts TD..



A..-STFDR/L 90 °	A..-STLDR/L 95 °	S..-STFDR/L 90 °	xx-STLDR 90 °
page(s) 473	page(s) 473	page(s) 474	page(s) 474

Inserts TN..



A..-PTFNR/L 90 °	A..-PTFNR/L 90 °	S..-MTFNR/L 90 °	A..-MTFNR/L 90 °	S..-MTUNR/L 90 °
page(s) 444, 445	page(s) 444, 445	page(s) 485, 487	page(s) 486	page(s) 488

Inserts TN.N



S..-CTUNR/L 93 °
page(s) 499

Inserts VB..

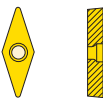

A..-SVUBR/L 93 °	A..-SVQBR/L 107,5 °
page(s) 475, 476, 477	page(s) 475, 476, 477

General ISO Turning
Technical information

Steadyline®

MDT

Mini-Shaft™

Grooving

Parting-off

X4

Adapters
Clamping units

Accessories and
Spare parts

Workpiece
materials

General ISO Turning
Technical information

Inserts VN..

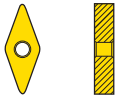

A..-PVLNR/L 95 °	A..-PVPNR/L 117,5 °	S..-MVPNR/L 117,5 °	S..-MVLNR/L 95 °	S..-MVYNR/L 95 °	A..-MVLNR/L 90 °
page(s) 446, 447	page(s) 446, 447	page(s) 489	page(s) 489	page(s) 492	page(s) 490

Steadyline®

A..-MVPNR/L 90 °	A..-MVUNR/L 90 °
page(s) 490	page(s) 491

MDT

Inserts WC..



A..-SWLCR/L 95 °
page(s) 478

Mini-Shaft™

Grooving

Inserts WN..



A..-PWLNR/L 95 °	S..-MWLNR/L 95 °	A..-MWLNR/L 90 °
page(s) 448, 449	page(s) 493, 495	page(s) 494

Parting-off

X4

Inserts WN.A



A..-DWLNR/L..-C 95 °
page(s) 435, 436

Adapters
Clamping units

Toolholders for boring

Inserts CC..



SCACL 90 °	S-SCACL 90 °	SCECL 60 °	S-SCECL 60 °	S-SCDCL 45 °
page(s) 501	page(s) 502	page(s) 501	page(s) 502	page(s) 503





Accessories and
Spare parts

Workpiece
materials

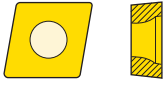
Cartridges

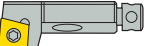

Inserts CC..

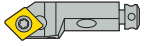

SCFCR/L 90 °	SCLCR/L 95 °	SCGCR/L 90 °	SCRCR/L 75 °	SCTCR/L 60 °	SCWCR/L 60 °
					
page(s) 504, 505	page(s) 504, 505	page(s) 506	page(s) 507	page(s) 507	page(s) 504, 505
SCSCR/L 45 °					
					
page(s) 506					

Inserts CN..



MCFNR/L 90 °	MCLNR/L 90 °
	
page(s) 513	page(s) 513

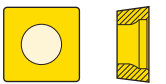

Inserts SC..



SSKCR/L 75 °

page(s) 508





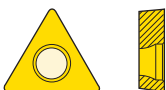

Inserts SN..



MSKNR/L 90 °	MSSNR/L 90 °	MSTNR/L 90 °
		
page(s) 514, 515	page(s) 514, 515	page(s) 515

Inserts TC..



STFCR/L 90 °	STGCR/L 90 °	STRCR/L 75 °	STTCR/L 60 °	STWCR/L 60 °	STSCR/L 45 °
					
page(s) 509, 510	page(s) 511, 512	page(s) 511, 512	page(s) 511, 512	page(s) 509, 510	page(s) 509, 510

General ISO Turning
Technical information

Steadyline®

MDT

Mini-Shaft™

Grooving

Parting-off

X4

Adapters
Clamping units

Accessories and
Spare parts

Workpiece
materials

General ISO Turning
Technical information

Inserts TN..



MTFNR/L
90 °

page(s) 516, 517

Steadyline®

GL-heads internal

Inserts CC..

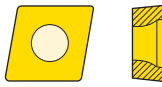

GL...DCLCR/L...JET 95 °	GL...SCLCR/L 95 °
page(s) 621	page(s) 636, 637, 638

MDT

Mini-Shaft™

Inserts CN..



GL...DCLNR/L...JET 95 °	GL...DCLNR/L 95 °
page(s) 622	page(s) 630, 631

Grooving

Parting-off

Inserts CN.N



GL...CCLNR/L
95 °

page(s) 653

X4

Adapters
Clamping units

Inserts DC..

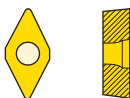

GL...DDUCR/L...JET 93 °	GL...SDUCR/L 93 °	GL...SDUCR/L...X 93 °	GL...SDXCR/L 62,5 °
page(s) 623, 624	page(s) 639, 640	page(s) 641, 642	page(s) 645, 646

Accessories and
Spare parts

Workpiece
materials

Inserts DN..

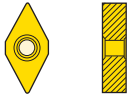

<p>GL...DDUNR/L...JET 93 °</p> <p>page(s) 625, 626</p>	<p>GL...DDUNR/L 93 °</p> <p>page(s) 632, 633</p>	<p>GL...SDXNR/L 62,5 °</p> <p>page(s) 647</p>	<p>GL...SDUNR/L 93 °</p> <p>page(s) 643</p>	<p>GL...SDUNR/L...X 93 °</p> <p>page(s) 644</p>
--	--	---	---	---

Inserts RN.N



<p>GL...CRSNR/L</p> <p>page(s) 654</p>
--

Inserts TC..

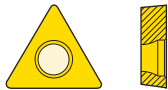

<p>GL...STFCR/L 90 °</p> <p>page(s) 648, 649</p>
--

Inserts TN.N



<p>GL...CTUNR/L 93 °</p> <p>page(s) 655</p>

Inserts VB..

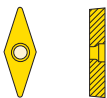

<p>GL...DVUBR/L...JET 93 °</p> <p>page(s) 627, 628</p>	<p>GL...SVUBR/L 93 °</p> <p>page(s) 650, 651</p>
--	--

Inserts VN..

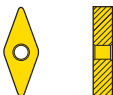

<p>GL...SVUNR/L 93 °</p> <p>page(s) 652</p>

General ISO Turning
Technical information

Steadyline®

MDT

Mini-Shaft™

Grooving

Parting-off

X4

Adapters
Clamping units

Accessories and
Spare parts

Workpiece
materials

General ISO Turning
Technical information

Inserts WN..

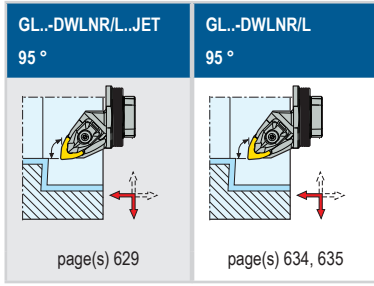
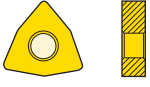

Steadyline®

MDT

Mini-Shaft™

Grooving

Parting-off

X4

Adapters
Clamping units

Accessories and
Spare parts

Workpiece
materials

Chipbreaker application areas – positive inserts

The chart below is to visualize three critical design elements in one diagram for positive basic shape inserts.

The first element is seen on the left side of the diagram with the following letters and explanations

F = Finish turning

M = Medium turning

R = Rough turning

and combinations thereof, also indicated in the description of the chipbreaker.

The second element is seen in the lower part of the diagram: A relative edge strength value, also indicated in the description of the chipbreaker.

The third element is the color code indicating the ISO workpiece material area as per the table and examples below and for each chipbreaker in the diagram further described below.

Chipbreaker chart for positive basic shape inserts

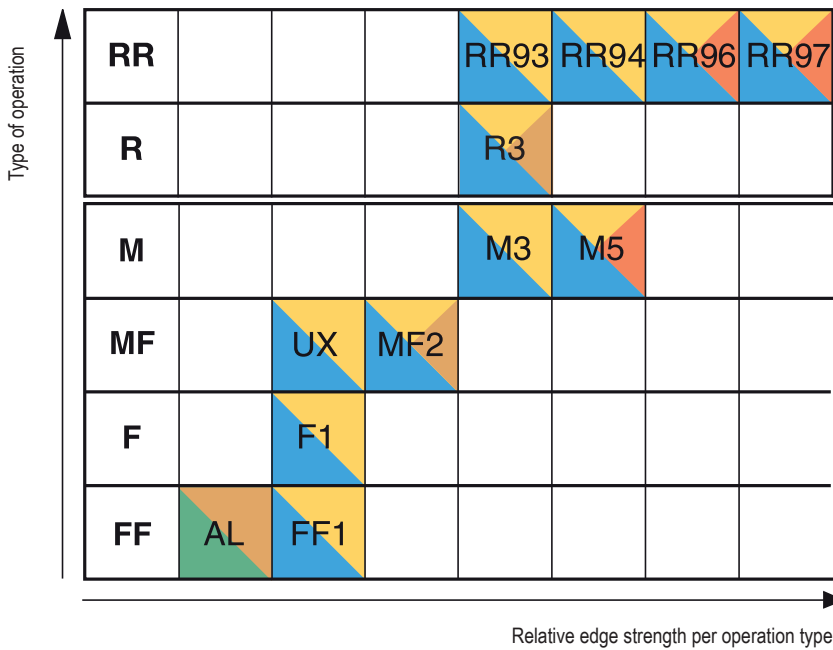

Steel P
Stainless steel M
Cast iron K
Non-ferrous metals N
Superalloys and titanium S
Hard materials H

ISO material group use, positive basic shape inserts



Superalloys (ISO S)
Non-ferrous alloys (ISO N)



Steel (ISO P)
Stainless steel (ISO M)



Steel (ISO P)
Stainless steel (ISO M)
Cast iron (ISO K)



Steel (ISO P)
Stainless steel (ISO M)
Superalloys (ISO S)

General ISO Turning
Technical information

Steadyline®

MDT

Mini-Shaft™

Grooving

Parting-off

X4

Adapters
Clamping units

Accessories and
Spare parts

Workpiece
materials

Chipbreaker application areas – negative inserts

The turning chipbreakers are designed to give the proper edge geometry for different application areas. The product designs are considering capability in chipbreaking, chipcontrol, edge toughness behavior, edge line integrity as well as the overall turning work to be done such as rough and finish turning for certain workpiece materials.

The idea with the chart below for negative basic shape inserts is to visualize three of these design elements in one diagram.

The first element is seen on the left side of the diagram with the letters

F = Finish turning

M = Medium turning

R = Rough turning

and combinations thereof also indicated in the description of the chipbreaker.

The second element is seen in the lower part of the diagram: A relative edge strength value, also indicated in the description of the chipbreaker.

The third element is the color code indicating the ISO workpiece material area as per the table on the previous page and examples below.

Chipbreaker chart for negative basic shape inserts

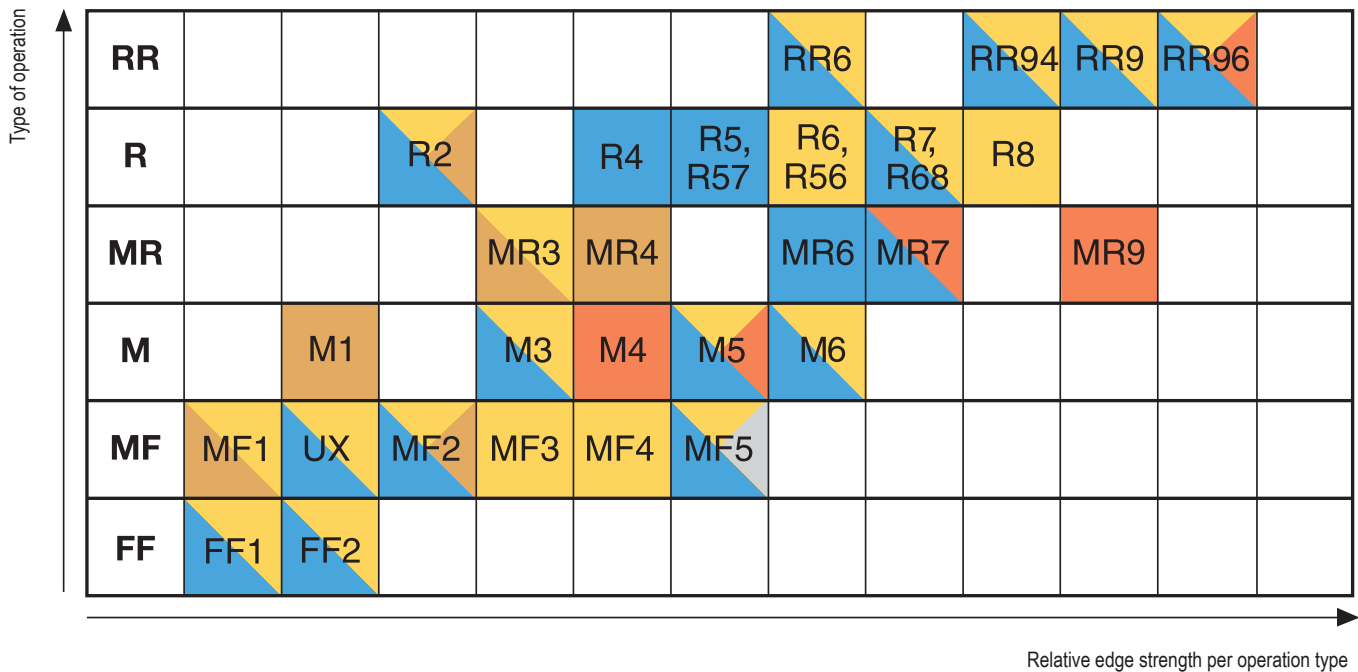

ISO material group use, negative basic shape inserts

	Stainless steel (ISO M) Superalloys (ISO S)		Steel (ISO P) Stainless steel (ISO M) Superalloys (ISO S)		Stainless steel (ISO M)
	Steel (ISO P) Stainless steel (ISO M) Hardened steel (ISO H)		Superalloys (ISO S)		Steel (ISO P) Stainless steel (ISO M) Cast iron (ISO K)
	Steel (ISO P) Cast iron (ISO K)		Cast iron (ISO K)		Steel (ISO P)

High Feed Wiper inserts – brief introduction

For the turning professional with an ambition to have higher effectiveness and efficiency, especially when looking at chipbreakers and connecting back to insert shapes there is a need to mention High Feed Wiper inserts.

Seco High Feed Wiper Inserts offer either

– Excellent surface finish and productivity at high feed rates

or

– Superior surface finish at normal feed rates

W	N	M	G	06	04	08	W	-	M3
1	2	3	4	5	6	7	8		9

Seco has a high feed wiper offering in inserts for most applications such as Advanced Materials and can for example be recognized by the "W" in the edge property "position 8" in the ISO insert Code Key as indicated above.

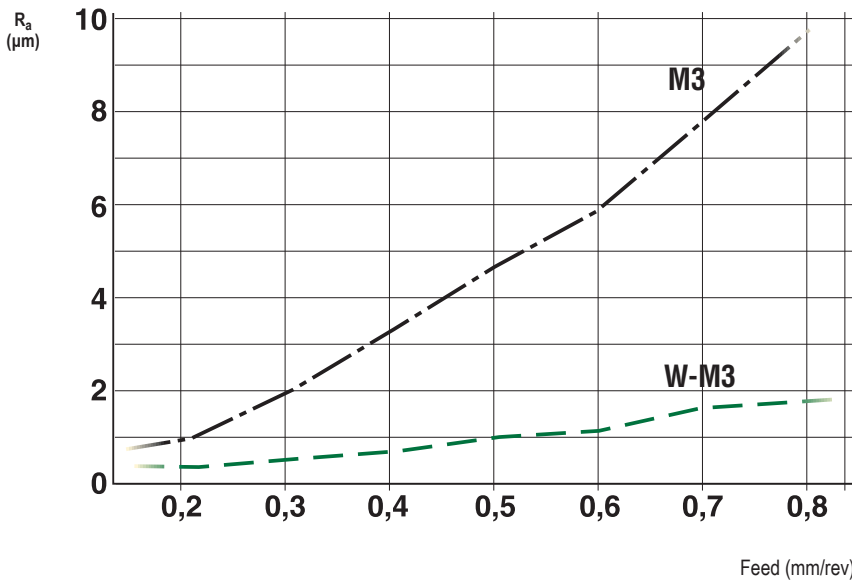

The outcome from using a High Feed Wiper insert can actually even eliminate the need for a separate finishing cut, which is indicated and described below.

According to the diagram above Seco High Feed Wiper Inserts (in this case CNMG120408W-M3, TP2501) shows an outcome with superior surface finish in R_a (see Y-axis) achieved in steel turning compared to standard insert (in this case CNMG120408-M3, TP2501).

For clarity the conditions for the test were 1mm depth of cut and cutting speed adjusted according to recommendations depending of feed used in SMG P4 longitudinal steel turning. Further details can be found exploring for example the www.secotools.com (see following pages).

General ISO Turning
Technical information

Steadyline®

MDT

Mini-Shaft™

Grooving

Parting-off

X4

Adapters
Clamping units

Accessories and
Spare parts

Workpiece
materials

Searching Turning Tools



To complement this present catalogue there are several ways to connect to www.secotools.com which help you make the use of your tools from Seco.

The webpage of www.secotools.com contains several entries like "Search for anything" including direct Product Search as well as the sequential route by clicking "Products" in the head-banner according to the below below, ending up in the view shown to the next page.

Under products you find overall applications and the Turning subgroups easily.

However, the "Search for anything" field in the heading gives instant access to many things available at www.secotools.com especially if you want to know more about the topic or tool you are looking for.

It is recommended to try yourself by reading the QR-code in the upper right corner for easy access alternatively search by Designation, Item-number, Grade or Type in www.secotools.com in any webbrowser or download and use this functionality in our Seco Assistant application, available in the Google Playstore or Apple App-store.

SECO		Search for anything!	Products	Indu
	Milling	>		General Turning - ISO
	Turning	<		Grooving and Parting-off
	Holemaking	>		Advanced Cutting Materials (PCBN PCD Ceramic)
	Threading	>		
	Tooling Systems	>		

General ISO Turning
Technical information

Steadyline®

MDT

Mini-Shaft™

Grooving

Parting-off

X4

Adapters
Clamping units

Accessories and
Spare parts

Workpiece
materials

Searching using filter options



General ISO Turning
Technical information

You can filter among our products here

Search

- Insert/Toolholder
- Toolholder options
- Insert pocket options
- Selection
- Insert options
- Chipbreaker options
- Workpiece material
- Applications
 - Longitudinal turning external
 - Turning external taper outward
 - Facing external
 - Radial plunging external
 - Longitudinal turning internal
 - Turning internal taper inward

If a Turning subgroup is chosen such as General Turning – ISO (previous page) you enter a filtering view (above) where several options open up, principal application types and workpiece materials in addition to all available features on inserts, chipbreakers and toolholders.

There are opportunities to expand each filter section by pressing the right-most "plus" as indicated done for the "Application"-section of the filter.

Search materials or select material category

Search standard material

14M

Select material from category

Name (Std)	DIN	Condition	Category	Rm N101	Rm range	WRC 60M	WRC range
UNI 16 MnCr 5	16 MnCr 5	Case hardened	K3	60	58-60		
UNI 16 MnCr 5	16 MnCr 5	Annealed	P3	550	430- 580		
EN 16 MnCr5 5	16 MnCr5 5	Case hardened	K3	59	58-60		
EN 16 MnCr5 5	16 MnCr5 5	Annealed	P3	550	430- 580		
EN 16 Mn 3	15 Mn 3	Annealed	P3	520	410- 580		
UNI 16 Mn 5	16 Mn 5	Annealed	P3	520	430- 580		
BS 818 M 40	36 CrNiMo 4	Quenched & Tempered	P5	750	550- 1200		

Steadyline®

MDT

Mini-Shaft™

Grooving

Parting-off

X4

Adapters
Clamping units

Accessories and
Spare parts

Workpiece
materials

Exploring cutting data recommendations



The screenshot displays the SECO website interface for product WNMG080412-M3 TP3501. The 'Cutting Data' section is active, showing parameters for 'Material: SMG P4' and 'Longitudinal turning external'. Key data points include: Number of passes (ap) 1, Depth of cut (ap) 2.0 mm, Feed/rev 0.34 mm/rev, and Cutting speed 355 m/min. The interface also features an 'Advanced Cutting Data' section with input fields for 'Desired number of passes (ap)', 'Desired feed/rev', and 'Desired cutting speed', along with a 'Calculate Cutting Data' button.

After filtering and choosing a specific product or directly product-searched an insert (in this case WNMG080412-M3,TP3501), the product specific information is accessed such as availability of stock and cutting data recommendations for the specific product (refer to the screenshot on the left).

However, there are many things to explore even when looking only at the cutting data view (lower left).

For example in the lower part of cutting data sheet there are options to refine the cutting data in order to get closer to any specific operation in particular. For example, the stock to be removed, number of passes estimated, or to adjust to the actual tensile strength of the steel. After you have made these changes, you can click on "Calculate Cutting Data", and the cutting data view will be updated accordingly.

For the turning professional there is also an "Advanced Cutting Data" section available when logged into MyPages.

This section will expand when clicking anywhere within the marked row.

Once you expand the "Advanced Cutting data", you will have access to change actual limitations such as "RPM", "Machine Power" and "Operation type – finishing" entering a surface finish requirement to come even closer to actual and specific application conditions.

Once again it is recommended that you try these yourself by reading the QR-code in the upper right corner for easy access alternatively search or type in directly www.secotools.com in a webbrowser.

If you are at the machine and not have access to a computer, you can find cutting data or machining calculators in the Seco Assistant app (see separate QR-code).

However also as indicated to the left there is further help for the turning professional to explore how to achieve maximum effectiveness and efficiency out of turning operations as long as you are logged in.

By further expanding into "Cutting Data Graphs" the dynamic graphs for the specific insert selected (in this case WNMG080412-M3 / WNMG433-M3,TP3501) give further detail visualizing (however not limited to) the recommended use of the insert. Generally the graphs show ranges for the basic cutting data together with the current result and the applicable constraints.

To the upper left there is a graph of the "Working Range" indicating the recommended depth of cut and feed range.

In the center the "Taylor-curve" diagram connects the estimated tool life and cutting speed recommendation for the chosen SMG category workpiece material and insert combination.

To the very right the "Speed Range" graph indicates the relationship between recommended speeds and feeds.

The turning professional should be aware that there are options to introduce constraints such as "Machine Power", "RPM" and "Surface finish" in cutting data calculations.

Consequently these kinds of constraints will then appear in graphs such as the below shown. It is highly recommended to try and explore how cutting calculations and cutting data graphs can provide insight and understanding for easier problem solving and during preparations of turning.

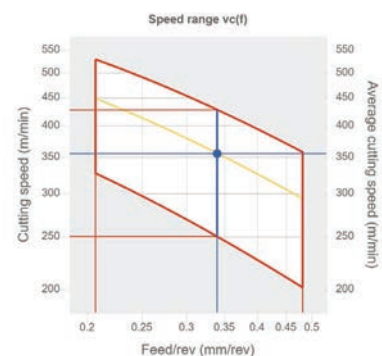
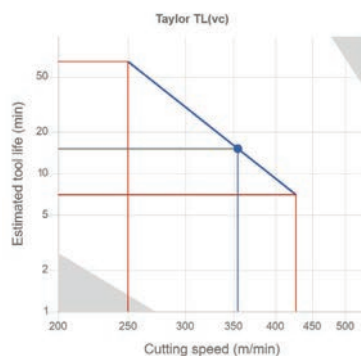
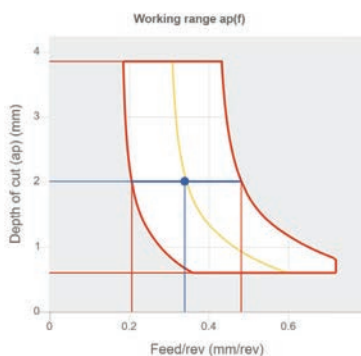

Component based product recommendations



General ISO Turning
Technical information

When starting from and considering a component instead of going directly to a turning product it is highly recommended that you use the Seco Suggest to search for tool recommendations based on principal components, applications and requirements. Below the entry view of Seco Suggest.

Please also note the four shortcut icons to the right of the screen shot above where Seco Suggest also can be accessed directly. Those are recommended to try yourself via reading the QR-code in the upper right corner for easy access by cell phone alternatively search or type in www.secotools.com as well as in your computer webbrowser or download and use this functionality in our new Seco Assistant application, available in the Google Playstore or Apple App-store.

Steadyline®

MDT

Mini-Shaft™

Grooving

Parting-off

X4

Adapters
Clamping units

Accessories and
Spare parts

Workpiece
materials



Insert grades – Carbide

To say that the choice of a grade everytime is easy may be an exaggeration, but there are easy rules of thumb to be used using the diagram below as a starting point.

If you are looking for the first choice grade, you could follow this methodology:

1. Start from the type of workpiece material. For example, in the table below, for steel, the ISO-P grades are the first choice.
2. You should look for black application coverage areas below first which indicate grades first of all designed for the application area then white for the complementary areas.
3. Then there are application divisions based on an ISO platform from center to i.e. for example P25 towards higher P35 which means tougher requirements and lower cutting speeds or P15 towards higher speeds or often higher surface requirements.
4. When one of the promising option chosen follow the row to the left i.e. if looking at medium turning with medium size inserts P25 the first choice would be Duratomic TP2501, but considering as high requirement on reliability but more versatility and less productivity focus the TP25 could be an option.

This is a straight-forward method giving a good first choice but there are several ways to address a skilled turning artisans' needs.

Indicative ISO classification of the grades

Steel P
Stainless steel M
Cast iron K
Non-ferrous metals N
Superalloys and titanium S
Hard materials H

	P					M					K					N				S				H					
	P01	P10	P20	P30	P40	P50	M01	M10	M20	M30	M40	K01	K10	K20	K30	K40	N01	N10	N20	N30	S01	S10	S20	S30	H01	H10	H20	H30	H40
TP0501	Black											White	White	White															
TP1501		Black	Black									White	White	White													White		
TP2501			Black	Black	Black			White	White			White	White	White															
TP3501				Black	Black				White			White	White	White															
TP25				Black	Black				White			White	White	White															
TP200				Black	Black				White			White	White	White															
TP40					Black					Black																			
TM1501			White					Black	Black																				
TM2501				White					Black	Black																			
TM3501					White					Black																			
TK0501												Black	Black	Black													White		
TK1501		White						White				Black	Black	Black															
TH1500												White														Black			
TS2000		White						Black				White	White	White								Black	Black	Black				White	
TS2050								White														Black	Black	Black				White	
TS2500			White						White													Black	Black	Black					
TH1000																						Black	Black	Black		Black			
CP200		White						Black				White	White	White								Black	Black	Black					
CP500			White						Black	Black			White	White									White	White					
CP600				White						Black													White	White					
TP1030	Black	Black						White																					
TP1020	Black	Black																											
HX									White			White	White	White								Black	Black	Black				White	
KX																						Black	Black	Black					
883									White			White	White	White								Black	Black	Black				White	
890									White			White	White	White								White	White					White	

The black areas in the chart indicate an insert's main ISO application groups and the white areas indicate other supplementary application groups.

An alternative would be to try finding a recommended solution in Seco systems yourself by reading the QR-code in the upper right corner for for easy access alternatively websearch or type in www.secotools.com/suggest in your webbrowser.

General ISO Turning
Technical information

Steadyline®

MDT

Mini-Shaft™

Grooving

Parting-off

X4

Adapters
Clamping units

Accessories and
Spare parts

Workpiece
materials

Introduction – PCBN

Polycrystalline Cubic Boron Nitride (PCBN) is a material which is sintered at extremely high pressure and high temperature into a wear-resistant material with properties close to those of diamond. Due to the hot hardness, oxidation resistance and fracture toughness of the material, inserts made of PCBN have excellent edge strength and long tool life when machining hard ferrous materials and pearlitic grey cast iron.

Secomax™ PCBN inserts are suitable for machining:

- Hardened steel (including hard-facing alloys)
- Pearlitic grey cast iron
- Chilled and white cast iron
- Manganese steel
- Cemented carbide
- Valve seat materials
- Powder Metallurgy (PM) alloys
- Nickel-based superalloys e.g. Inconel 718

For more information including a comprehensive guide to understanding and applying PCBN successfully, please ask your sales representative for the Secomax™ PCBN, Technical Guide (available in English).

Insert grades – PCBN

The Secomax™ PCBN range of grades consists of both coated and uncoated grades. The application areas for the Secomax™ grades are shown below.

Indicative ISO classification of the grades

Steel P
Stainless steel M
Cast iron K
Non-ferrous metals N
Superalloys and titanium S
Hard materials H

	P					M					K					N				S				H						
	P01	P10	P20	P30	P40	P50	M01	M10	M20	M30	M40	K01	K10	K20	K30	K40	N01	N10	N20	N30	S01	S10	S20	S30	H01	H10	H20	H30	H40	
CBN010																														
CBN060K																														
CBN150																														
CBN170																														
CBN170C																														
CBN200																														
CBN300																														
CBN300P																														
CBN400C																														
CBN500																														
CBN600																														
CH0550																														
CH2540																														
CH3515																														
CK2065																														

The black areas in the chart indicate an insert's main ISO application groups and the white areas indicate other supplementary application groups.

General ISO Turning
Technical information

Steadyline®

MDT

Mini-Shaft™

Grooving

Parting-off

X4

Adapters
Clamping units

Accessories and
Spare parts

Workpiece
materials

Introduction – PCD

Polycrystalline Diamond (PCD) is produced by sintering together carefully selected particles of diamond under conditions of high temperature and high pressure. PCD cutting tools combine the hardness, abrasion resistance and thermal conductivity of diamond with the toughness of tungsten carbide.

Secomax™ PCD inserts are suitable for machining non-ferrous metals and alloys, e.g.:

- Aluminium
- Copper
- Brass
- Bronze

It can also be used for other materials, e.g.:

- Composites (MMC, ...)
- Reinforced plastics
- Graphite
- Cemented/tungsten carbide
- Ceramics
- Titanium alloys

Indicative ISO classification of the grades

Steel P
Stainless steel M
Cast iron K
Non-ferrous metals N
Superalloys and titanium S
Hard materials H

	P					M					K					N				S				H					
	P01	P10	P20	P30	P40	P50	M01	M10	M20	M30	M40	K01	K10	K20	K30	K40	N01	N10	N20	N30	S01	S10	S20	S30	H01	H10	H20	H30	H40
PCD20																													
PCD30																													

General ISO Turning
Technical information

Steadyline®

MDT

Mini-Shaft™

Grooving

Parting-off

X4

Adapters
Clamping units

Accessories and
Spare parts

Workpiece
materials

Introduction – Ceramic

Secomax ceramics include a range of products developed to meet the manufacturing industries ever increasing demands on productivity and product performance.

The inserts are die-pressed and sintered by a HIP process using very fine and pure raw materials with fine microstructure to reach excellent material properties. All surfaces are then ground ensuring a product with superior dimensions and tolerances.

This comes together in a product with outstanding features:

- high thermal shock resistance
- optimised fracture toughness
- excellent wear resistance
- high product quality

Application areas

Heat resistant superalloys (HRSA) include a broad range of nickel, iron and cobalt based alloys developed specifically for applications demanding exceptional mechanical and chemical properties at elevated temperatures.

Seco ceramic inserts are intended for rough machining of nickel based heat resistant superalloys. The most common nickel based superalloy is Inconel 718, which is a precipitation hardenable nickel chromium alloy containing significant amounts of iron, niobium and molybdenum along with lesser amounts of aluminium and titanium.

Other common nickel based superalloy names are:

- Hastalloy
- Haynes (Waspaloy)
- MAR
- Nimonic
- Rene
- Udimet

Indicative ISO classification of the grades

Steel P
Stainless steel M
Cast iron K
Non-ferrous metals N
Superalloys and titanium S
Hard materials H

	P					M					K					N				S				H					
	P01	P10	P20	P30	P40	P50	M01	M10	M20	M30	M40	K01	K10	K20	K30	K40	N01	N10	N20	N30	S01	S10	S20	S30	H01	H10	H20	H30	H40
CS100																													
CS300																													
CW100																													

General ISO Turning
Technical information

Steadyline®

MDT

Mini-Shaft™

Grooving

Parting-off

X4

Adapters
Clamping units

Accessories and
Spare parts

Workpiece
materials



Turning problems & recommended solutions

Search and install the Seco Assistant App on AppStore or GooglePlay. Please explore the app for example Utilities and connected to this page Tool Optimization under Turning. Here you get a more complete list of recommended solution options.

Too long unstable chips (e.g. risks for tangling)

One of the main concerns even for the turning professional is the chipcontrol often concerning chipbreaking. Here is how to start:

Too long unstable chips (e.g. risks for tangling)

1. Try increasing the feed rate and/or depth of cut
2. Change to a more suitable tighter chipbreaker. Use the chart on page(s) 61-62 and choose one below or to the left of the one in present use or search a recommended insert via www.secotools.com/suggest
3. Start the Seco Assistant app. Check under Utilities/Tool Optimization/Turning/Poor chip control for a more complete list of options

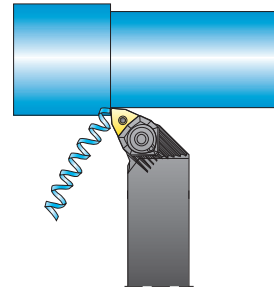

Too hard-curlled very short chips (e.g. risks for excess heat)

1. Try lowering the feed rate and/or depth of cut
2. Change to a more suitable open chipbreaker. Use the chart on page(s) 61-62 and choose one above or to the right of the one in present use or search a recommended insert via www.secotools.com/suggest
3. Start the Seco Assistant app. Check under Utilities/Tool Optimization/Turning/Hard chip control for a more complete list of options

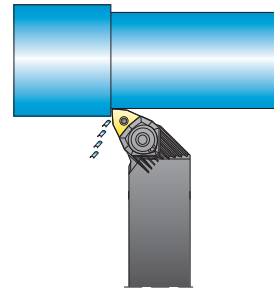

Too much vibrations (e.g. risk marks and breakages)

1. Secure workpiece clamping and tools
2. Try changing cutting speed and/or feed
3. Reduce the depth of cut
4. Select a more easy-cutting chipbreaker. Use the chart on page(s) 61-62 and choose one often left of the present in use or search recommended products via www.secotools.com/suggest
5. Start the Seco Assistant app. Check under Utilities/Tool Optimization/Turning/Vibrations for a more complete list of options



Poor surface finish (e.g. risk not reach requirements)

1. Reduce the feed rate
2. Increase cutting speed
3. Select a high-feed Wiper insert chipbreaker in accordance to the code key then use the product-search feature at www.secotools.com or search recommended products via www.secotools.com/suggest
4. Start the Seco Assistant app. Check under Utilities/Tool Optimization/Turning/Poor surface finish for a more complete list of options



Optimization – Wear

When optimizing tool life for coated carbide grade inserts we ought to look at and consider wear behavior which to a high degree relates to the workpiece material and conditions for a turning application.

A general straight-forward method to achieve optimum tool life could be described as the below chart as long as there are freedom to change cutting speed and feed rate. However it requires some insight in insert wear as in the picture indicated below, but most turning professionals have to consider that any severe wear process may end up with a fracture.

The diagram below should be read in the following way for example if you find plastic deformation as indicated in "3" you should reduce the feed and/or speed to have a stable flank wear as indicated in "1" to get long tool life.

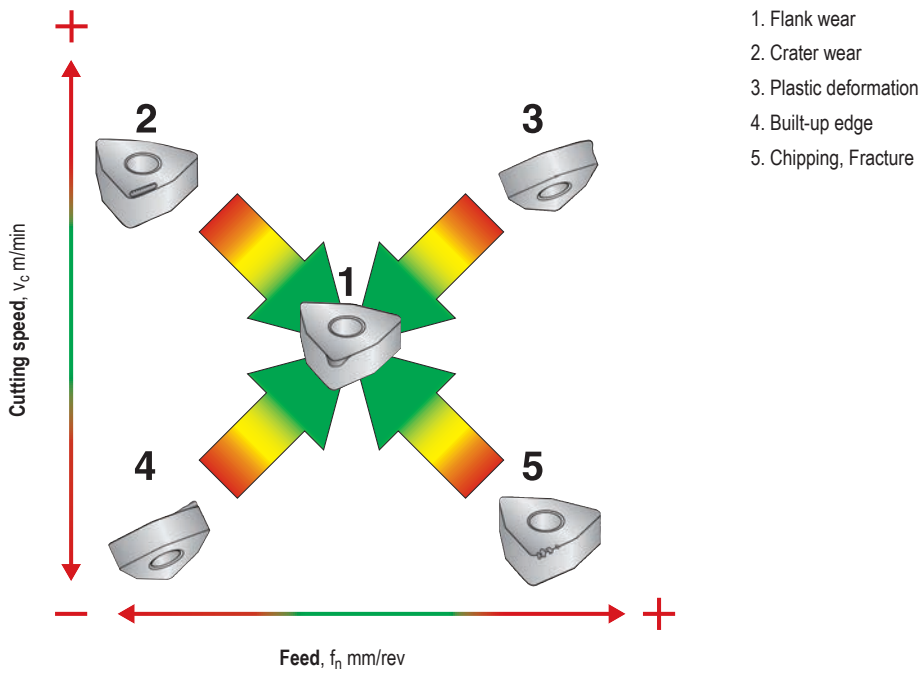

1. Flank wear
2. Crater wear
3. Plastic deformation
4. Built-up edge
5. Chipping, Fracture

Insert wear and failure modes

When in need to go in more depth on the topic of wear of coated carbide insert and solve challenges based on wear processes the following collection will provide a comprehensive platform.

Normal flank wear

The normal flank wear, since it is uniform, predictable and dependable, is the most desirable wear mode.

Cause

Abrasive wear. Hard microscopic inclusions often of carbides at workpiece material surface in contact with insert cut into the insert. In some cases fractions of non-contained microscopic hard particles that cannot be retained in a matrix may tumble between surfaces in contact and also cut into the insert. An irregular flank wear that initially may look uniform, as well as too rapid though uniform flank wear, prematurely reaching a set target wear criterion, requires a corrective action in some form.

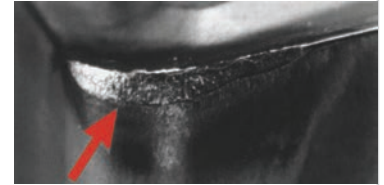

What to look for

- Relatively uniform abrasion along the cutting edge
 - Non-uniform appearance may indicate influence of other wear modes (see other wear descriptions)
- Note: Metal from the workpiece can be smeared over the cutting edge and can exaggerate the apparent size of the wear scar.

When to expect it

- In all materials, an insert will finally fail due to normal flank wear if it doesn't fail from something else first.

Corrective actions (to rapid flank wear)

- Select a more wear resistant, harder, or coated carbide grade
- Reduce the cutting speed (or RPM)
- Apply coolant correctly
- If possible, select insert with larger radius

Crater wear

Cause

A combination of chemical diffusion, decomposition and abrasive wear causes cratering. Classically, the heat from workpiece chips decomposes the tungsten carbide grains in the substrate, and carbon leaches into the chips (diffusion), creating a 'crater' on the top surface or rake face of the insert. The crater will eventually grow large enough to cause the insert to fail e.g. by chipping or rapid flank wear. Modern coating technology such as Duratomic® has reduced this wear mode drastically, but when trying to improve the productivity, using higher cutting data, it inevitably appears again.

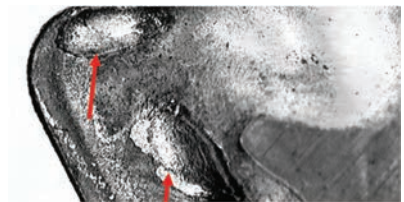

What to look for

- Craters or pits on the top or the rake face of the inserts
- Chipbreaking may change to better or worse after cratering started

When to expect it

- Iron or titanium-based alloys

Corrective actions

- Use wear resistant grades and if needed try another grade with other coating design
- Or reduce heat by...
- Using coolant
 - Using a freer cutting geometry
 - Reducing the cutting speed (or RPM)
 - Changing feed rate

Built-up edge

Cause

Material adhesion. Built-up edge (BUE) is a result of the workpiece material being pressure welded to the cutting edge. This could be an indicator of exit conditions from cutting in workpiece materials with high chemical affinity, high cutting forces/pressure, and locally insufficient temperature around the cutting zone. The wear mode itself could in some cases even be beneficial for tool life, but the consequence of built-up edge breaks off and allows chips to bring pieces of the insert with it or acting as an indicator of chipping, notching or other discontinuous wear modes, makes it important.

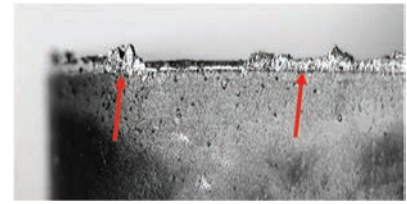

What to look for

- Shiny material on the top or flank of the insert edge
- Erratic changes in part size or surface finish

When to expect it

- High temp alloys and stainless steel and other workpiece materials appearing 'gummy'
- At relatively low speeds especially at limited cuts e.g. facing to center & parting-off and even more apparent in the centre of a drill

Corrective actions

- Change of grade to other coating designs may reduce built-up edge.
- Increase the cutting speed (or RPM) or increase the feed rate
- Try an insert with a sharper cutting edge geometry
- Apply coolant correctly or not at all; perhaps do another check on the emulsion concentration

Chipping

Cause

Mechanical instability or material adhesion. Chipping of the insert edge could be a result of vibrations in the workpiece or spindle. Larger hard inclusions in the material being cut and interrupted cuts may result in local stress concentrations that can cause chipping. In addition adhered material may cause a tensile stress that on removal can tear off parts of an insert.

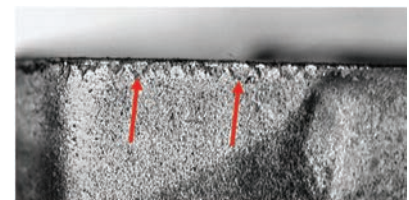

What to look for

- Chipping along the edge of the insert

When to expect it

- Non-rigid set-ups (bad bearings, worn spindles, etc.)
- Demanding entrance and exit conditions
- Hard spots at well as soft spots in work materials
- Powder Metallurgically (PM) made materials

Corrective actions

- Ensure rigid machine tool setup
- Change over to tougher insert grade or stronger cutting edge geometry
- Reduce the feed rate
- In some cases, turn-off the coolant
- See also corrective actions for built-up edge

General ISO Turning
Technical information

Steadyline®

MDT

Mini-Shaft™

Grooving

Parting-off

X4

Adapters
Clamping units

Accessories and
Spare parts

Workpiece
materials

General ISO Turning
Technical information

Steadyline®

MDT

Mini-Shaft™

Grooving

Parting-off

X4

Adapters
Clamping units

Accessories and
Spare parts

Workpiece
materials

Thermomechanical failure

Cause

A combination of thermal cycling (frequency changing the working temperature for the insert rapidly), thermal load (amount of heat), thermal shock (fast temperature change from warm to cold and the other way around in different zones), and mechanical shock (stress change from release to full load) causes thermo mechanical failure. Stress cracks form along the insert edge, eventually causing sections of carbide to pull out and appear to be chipping. Seen most commonly in milling.

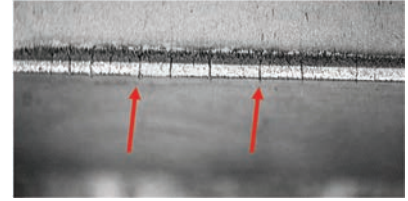

What to look for

- Multiple cracks perpendicular to cutting edge
- Irregular chipping on edges or wear spots on rake face

When to expect it

- Intermittent cuts e.g. facing over slots, but also tool paths when machining a large number of parts creating the thermal cycling or intermittence in coolant flow

Corrective Actions

- Apply coolant differently or not at all
- Select a tougher grade
- Reduce the cutting speed (or RPM) or reducing the feed rate
- Use a free-cutting geometry or chipbreaker to reduce heat

Edge deformation

Cause

Thermal overloading. Excessive heat causes the carbide binder (cobalt) to soften. It could come in combination with mechanical overloading where the pressure of the insert against the workpiece all in all making an insert edge deform partly or fully, eventually breaking off or leading to irregular flank wear.

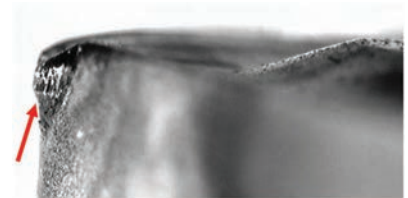

What to look for

- Deformation at the cutting edge or excessive irregular flank wear
- The dimensions of the workpiece may change drastically

When to expect it

- High speed and/or high feed rates
- Hard steels or work-hardened surfaces
- High temperature superalloys or stainless steels

Corrective actions

- Apply coolant correctly
- Try a harder, more wear resistant grade
- Reduce cutting speed (or RPM) or reduce the feed rate
- Select an insert with other geometric features

Notching

Cause

Combinations of local properties in workpiece materials and cutting conditions. Notching is often caused by the conditions at the surface of the workpiece e.g. surface hardening from previous cuts, forged or cast surfaces, or surface scale. This causes the insert to wear more rapidly in that part of the cutting zone. Local stress concentration can also lead to notching as a result of the compressive stress along the cutting edge and lack of the same behind the cutting edge – the insert is particularly affected at the depth of cut.

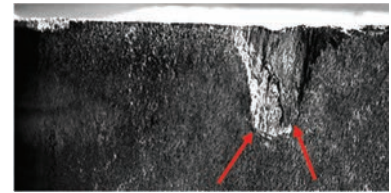

What to look for

– Notching or clusters of chippings for example at the depth of cut area on the insert

Note: The notch could be of two kinds; the smoother which indicate more chemical/abrasive interaction or the irregular more mechanical/adhesive extensive chipping.

When to expect it

- Materials with surface scale or oxidation
- Work hardening materials
- Cast or other process affected surfaces

Corrective actions

- Vary the depth of cut
- Adjust the feed rate or increase cutting speed (Note: This will generate more flank wear)
- Select a tougher insert grade
- Exchange chipbreaker design drastically
- Prevent built-up edge

Mechanical fracture

Cause

Excessive load (also caused by other wear modes than finally) can cause mechanical fracture. Mechanical overload could of course cause the insert to break from the first moments in a cut to the exit or even after the release from cut. To be considered are also surrounding cutting conditions such as the conditions of the shim, workpiece clamping or machine condition.

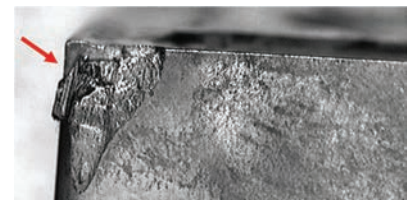

What to look for

- Fracture of insert (e.g. appearing as irregular flank wear often at the insert radius)
- Sudden increase of cutting force level

When to expect it

- Inhomogeneous workpieces e.g. with major inclusions, pores or design features that cause heavy impact or load release
- Unstable cutting conditions
- Low cutting data especially cutting speed

Corrective actions

- Reduce the feed rate or the depth of cut
- Increase speed
- Verify set-up rigidity
- Select a tougher insert grade or a more secure insert or cutting edge
- If possible reduce workpiece's inclusions and difficult geometrical features

Optimisation – Grades

However when considering wear there are limitations as well as property relations for each and between every grade even though Duratomic grades have redefined the actual opportunities considering productivity and tool life.

When looking at the simple coated cemented carbide grade overview for steel turning in the chart below, you can see that the TP2501 grade is placed in the center corresponding to the P25 application area referred earlier. However, in this chart, the speed capabilities of different grades and their wear properties are illustrated with more clarity.

Steel

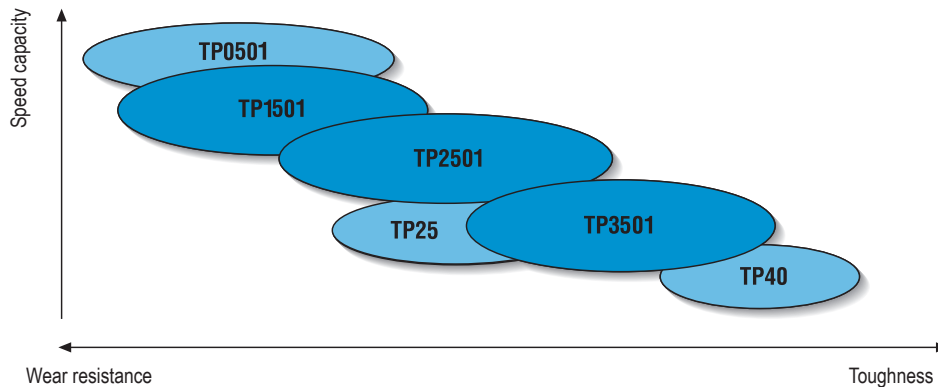

That means a chain of property relations could guide you towards a more insightful choice e.g. if you are after dry continuous steel turning TP0501 is a good choice, but lower speed medium turning application TP25 is better.

When instead, looking at the simple coated cemented carbide grade overview for stainless steel turning area below the number of grades introduced in the diagram have grown. However, the pattern where TM2501 is placed in the center, corresponding to the M25 application area can be recognized.

Stainless steel

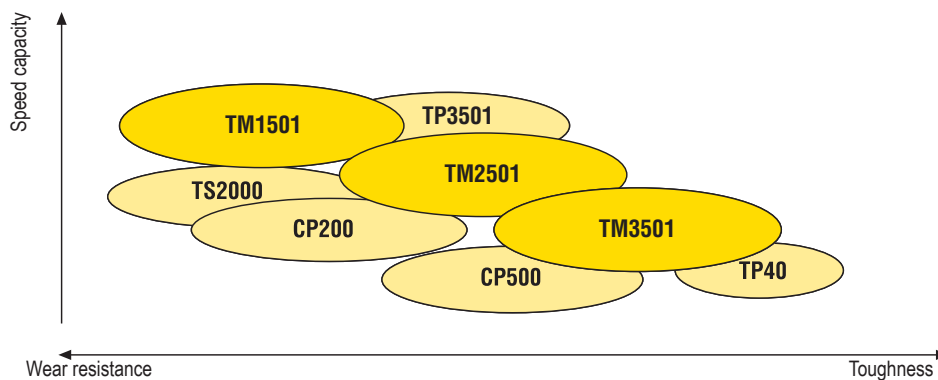

The well connected TM1501, TM2501 and TM3501 Duratomic grade chain covers applications in stainless steel turning, but also the thin PVD-coated TS2000, CP200 to CP500 complements the above high productivity CVD grades with reliability, but not at as high speeds as the Duratomic grades.

On the other hand TP3501 has been designed to have complementary properties to work in stainless steels despite the grade was developed for steel turning.

Troubleshooting – PCBN

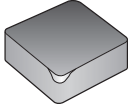
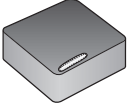
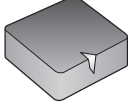
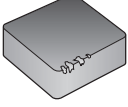
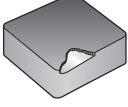
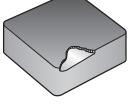
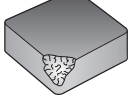
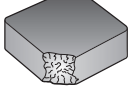
Problem	Cause	Suggested action(s)
Flank wear 	<ul style="list-style-type: none"> • Not correct edge temperature 	<ul style="list-style-type: none"> • Increase cutting speed • Increase feed rate • Increase depth of cut • Check cutting tool centre height • Check the ferrite content
Crater wear 	<ul style="list-style-type: none"> • Not correct edge temperature 	<ul style="list-style-type: none"> • Decrease cutting speed • Decrease feed rate • Reduce chamfer angle • Use E edge preparation • Use coated insert • Use coolant (only in continuous cut)
Notch wear 	<ul style="list-style-type: none"> • Not correct edge temperature • Too high cutting forces 	<ul style="list-style-type: none"> • Increase cutting speed • Decrease feed rate • Increase insert approach angle (preferably round inserts) • Vary the depth of cut • Use inserts with chamfered cutting edges
Edge chipping 	<ul style="list-style-type: none"> • Too high cutting forces 	<ul style="list-style-type: none"> • Use inserts with chamfered cutting edges • Increase system rigidity • For interrupted cuts, chamfer the tool entry/exit slots and holes • Vary the cutting speed to eliminate vibrations
Edge flaking (continuous cut) 	<ul style="list-style-type: none"> • Too high cutting forces 	<ul style="list-style-type: none"> • Increase cutting speed • Reduce feed rate • Use chamfered and honed cutting edges • Check cutting tool center height • Reduce insert approach angle
Edge flaking (interrupted cut) 	<ul style="list-style-type: none"> • Too high cutting forces 	<ul style="list-style-type: none"> • Do not use coolant • Use chamfered and honed cutting edges • Reduce feed rate • Increase cutting speed • Check cutting tool centre height • Reduce insert approach angle
Edge breakage 	<ul style="list-style-type: none"> • Too high cutting forces 	<ul style="list-style-type: none"> • Reduce depth of cut • Reduce cutting speed • Increase nose radius • Use chamfered and honed inserts • Check cutting tool center height
Insert breakage 	<ul style="list-style-type: none"> • Too high cutting forces 	<ul style="list-style-type: none"> • Check insert seating • Check insert shim and insert clamp • Check cutting tool centre height

General ISO Turning
Technical information

Steadyline®

MDT

Mini-Shaft™

Grooving

Parting-off



X4

Adapters
Clamping units

Accessories and
Spare parts

Workpiece
materials

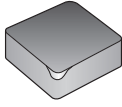
Troubleshooting – PCD

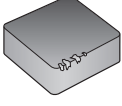
Problem	Cause	Suggested action(s)
Flank wear 	<ul style="list-style-type: none"> • Wrong grade • Presence of Fe/Ni/Co 	<ul style="list-style-type: none"> • Change to coarser PCD grade • Check material composition • Reduce cutting speed • Use coolant
Built-up edge 	<ul style="list-style-type: none"> • Not correct edge temperature • Wrong grade 	<ul style="list-style-type: none"> • Decrease or increase cutting speed • Choose a sharper insert • Change to a finer grade
Edge chipping 	<ul style="list-style-type: none"> • Poor rigidity • Wrong grade • Incorrect cutting data • High run-out 	<ul style="list-style-type: none"> • Minimize vibrations • Change to a tougher grade • Change cutting data • Check set-up
Poor surface finish	<ul style="list-style-type: none"> • Wrong grade • Too high cutting data • Incorrect wiper position 	<ul style="list-style-type: none"> • Change to a finer PCD grade • Reduce cutting speed and feed rate • Check wiper position
Flaking of workpiece	<ul style="list-style-type: none"> • To high depth of cut 	<ul style="list-style-type: none"> • Decrease depth of cut • Add entry chamfer on component

General ISO Turning
Technical information

Steadyline®

MDT

Mini-Shaft™

Grooving

Parting-off



X4

Adapters
Clamping units

Accessories and
Spare parts

Workpiece
materials

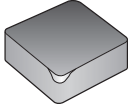
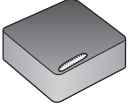
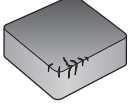
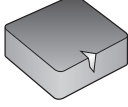
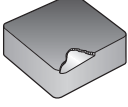
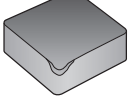
Troubleshooting – Ceramics

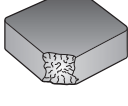
Problem		Cause	Suggested action(s)
Flank wear		<ul style="list-style-type: none"> Excessive feed rate and cutting speed 	<ul style="list-style-type: none"> Reduce cutting speed Use larger corner radius Use high wear-resistant grade
Crater wear		<ul style="list-style-type: none"> Excessive feed rate and cutting speed 	<ul style="list-style-type: none"> Reduce cutting speed Use smaller lead angle Check edge geometry
Thermal cracking		<ul style="list-style-type: none"> Severe cycle of heating & cooling during cutting Excessive feed rate and cutting speed 	<ul style="list-style-type: none"> Change to dry machining Reduce cutting speed Reduce feed rate
Notch wear		<ul style="list-style-type: none"> Excessive feed rate and cutting depth 	<ul style="list-style-type: none"> Reduce cutting depth Reduce feed rate Increase coolant supply
Edge flaking		<ul style="list-style-type: none"> Excessive feed rate Separation of BUE Weak cutting edge 	<ul style="list-style-type: none"> Check edge geometry Increase stability of the system Use larger lead angle
Plastic deformation		<ul style="list-style-type: none"> Excessive feed rate and cutting speed 	<ul style="list-style-type: none"> Reduce cutting speed Reduce feed rate Reduce cutting depth
Built-up edge		<ul style="list-style-type: none"> High affinity with workpiece Low cutting speed 	<ul style="list-style-type: none"> Increase cutting speed Increase feed rate Use larger rake angle
Breakage		<ul style="list-style-type: none"> Excessive feed rate and cutting depth 	<ul style="list-style-type: none"> Reduce feed rate Reduce cutting depth Increase stability of the system

General ISO Turning
Technical information

Steadyline®

MDT

Mini-Shaft™

Grooving

Parting-off

X4

Adapters
Clamping units

Accessories and
Spare parts

Workpiece
materials

ISO attributes

ISO attribute	Explanation
AN	clearance angle major
B	shank width
BAWS	workpiece side body angle
BD	body diameter
BLQ	balance quality code
CDRX	cutting depth radial maximum
CDX	cutting depth maximum
CDXI	cutting depth maximum insert
CDXSH	cutting depth maximum shank
CF	spot chamfer
CNT	coolant entry thread size
CP	coolant pressure
CTMS	connection text machine side
CTWS	connection text workpiece side
CUTDIA	work piece parting diameter maximum
CW	cutting width
D1	fixing hole diameter
DCB	connection bore diameter
DCB1	connection bore diameter 1
DCB2	connection bore diameter 2
DCINN	cutting diameter internal minimum
DCINN2	cutting diameter internal minimum 2
DCINN3	cutting diameter internal minimum 3
DCP	data chip provision
DCSFMS	contact surface diameter machine side
DF	flange diameter
DIX	tool changer interference diameter maximum
DMM	shank diameter
EPSR	insert included angle
GAMO	rake angle orthogonal
H	shank height
HF	functional height
HRY	measure, Measure from ref. plane of mounting to bottom plane of unit in direction Y m
IC	inscribed circle diameter
INPLM	minimum initial plunge diameter
INPLX	initial plunge maximum
INSD	insert diameter
INSL	insert length
KCHL	corner chamfer angle left hand
KCHR	corner chamfer angle right hand
L	cutting edge length
LAMS	inclination angle
LB1	body length 1
LB2	body length 2
LCOG	length to center of gravity
LF	functional length
LF2	functional length_2
LFS	functional length secondary
LH	head length
LH2	head length 2
LIG	insert gauge length
LPR	protruding length

General ISO Turning Technical information
Steadyline®
MDT
Mini-Shaft™
Grooving
Parting-off
X4
Adapters Clamping units
Accessories and Spare parts
Workpiece materials

ISO attribute	Explanation
LS	shank length
LSC	clamping length
LU	usable length
OAH	overall height
OAL	overall length
OAW	overall width
PDX	profile distance ex
PSIRL	cutting edge angle major left hand
PSIRR	cutting edge angle major right hand
RADH	radial body height
RADW	radial body width
RE	corner radius
RETL	flank radius left hand
RETR	flank radius right hand
RoundedUpWeight	roundedUpWeight
RPMX	rotational speed maximum
S	insert thickness
TDZ	thread diameter size
TPI	threads per inch
W1	insert width
WF	functional width
WF2	functional width 2
WFS	functional width secondary

General ISO Turning
Technical information

Steadyline®

MDT

Mini-Shaft™

Grooving

Parting-off

X4

Adapters
Clamping units

Accessories and
Spare parts

Workpiece
materials

Toolholders, insert clamping principles

D Toolholder First choice for general machining, external

- For negative basic shape inserts with hole
- Robust, stable locking arrangement

The insert is locked in position by means of a clamp which presses the insert into and down onto the fixed insert seat

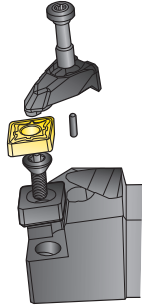

D.....-C Toolholder

- With pin and carbide pressure plate

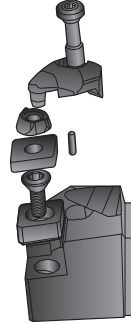

D.....-JETI Toolholder

- With coolant clamp for Jetstream Tooling

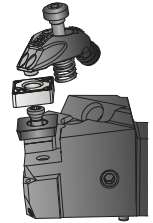

P Toolholder A complement to the D Toolholder, external

- For negative inserts with hole
- No clamp on the top, facilitates free chip flow

In the illustration when the clamping screw is tightened and the toggle lever secures the insert in the insert seat with a shim by a shim clip

In the alternative design the clamping screw acts upon the wedge that pushes the insert towards the centre pin according to the illustration to the right

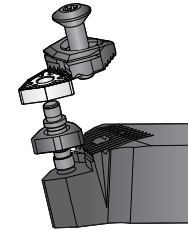
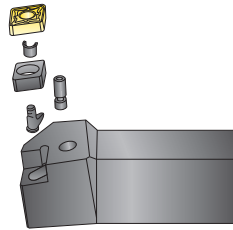

C Toolholder Designed mainly for Seco PCBN inserts without hole

The insert is locked in position by means of a clamp, which is equipped with a carbide plate

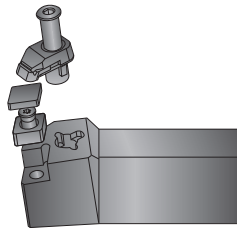

S Toolholder For external and internal turning with positive inserts

The insert is locked in position by a centre screw

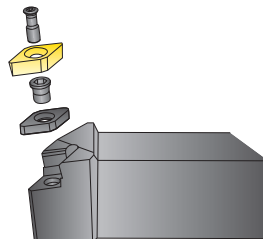

General ISO Turning
 Technical information

Steadyline®

MDT

Mini-Shaft™

Grooving

Parting-off

X4

Adapters
 Clamping units

Accessories and
 Spare parts

Workpiece
 materials

Jetstream Tooling® – Introduction

Seco Jetstream Tooling® is a revolutionary solution to the problem of delivering coolant precisely to the cutting zone. It works by delivering a concentrated high pressure jet of coolant at high velocity straight to the optimum position close to the cutting edge. The jet lifts the chips away from rake face, improving chip control and tool life enabling increased cutting data. It is proven to show improvement in nearly all material groups and with a wide choice of coolant pressures.

Seco Jetstream Tooling® consists of holders for external turning, both square shanks, Parting-off blades and Seco-Capto™ backends. For internal turning, Jetstream Tooling® capability is being integrated to JET GL-Turning heads for Steadyline® and some internal turning bars with the help of the unique coolant clamps. It can be mounted and used on a large selection of machines. For general ISO turning coolant can either be supplied to the toolholder internally in the case of JETI or Seco-Capto™ toolholders or externally through a coolant hose.

The JETI product platform is developed with a compact assembly in mind. The JETI toolholders with integrated coolant channels eliminates the need for any external piping and connections that would otherwise obstruct machine movements in tight workspaces. Integrated channels in adapter and toolholder make it possible for coolant to reach the cutting edge directly from the adapter.

Hoses for external connection which is attached to one of the inlet positions of the toolholder allow the coolant supply to be connected to almost any position on the turret or tool block.

Seco Jetstream Tooling® Duo toolholders, feature both a rake face and flank face jet, that may provide even better chip control and significantly longer tool life.

Products are available for ISO turning with positive and negative inserts, as well as for Grooving and Parting-off. Note that it is up to the turning professional to make sure that all aspects of health and security are fulfilled.

Insert carrier	Maximum recommended coolant pressure	
	bar	psi
Square shank with hose	275	4000
GL-Head with Steadyline® bar - Cylindrical	200	3000
GL-Head with Steadyline® bar – HSK	100	1500
GL-Head with Steadyline® bar – Seco-Capto™ (with coolant tubes)	70 (150)	1000 (2000)
Seco-Capto (with coolant tubes)	70 (150)	1000 (2000)
JETI toolholders and blades	200	3000

Adapters	Maximum recommended coolant pressure	
	bar	psi
JETI Adapter with Seco-Capto™ (with coolant tubes)	70 (150)	1000 (2000)
JETI Adapter with VDI	80	1100 (2000)
JETI Adapter with HSK-T	100	1500
JETI Adapter with Square shank	275	4000

When using toolholder together with an adapter the maximum coolant pressure is limited to the adapter's maximum coolant pressure.

Designation of Jetstream Tooling® holders follows ISO, see page(s) 11-16, 17-18.

Jetstream Tooling® for Grooving and Parting-off, see page(s) 661, 909, 939.



- General ISO Turning Technical information
- Steadyline®
- MDT
- Mini-Shaft™
- Grooving
- Parting-off
- X4
- Adapters Clamping units
- Accessories and Spare parts
- Workpiece materials

Coolant clamps

The unique 3D printed coolant clamps



The coolant clamp executes many functions. It provides a secure and fast clamping of the insert by virtue of the spring loaded design with a single screw. It directs and orients the high pressure coolant jets straight and close to the cutting edge. The manufacturing flexibility of the coolant clamp allows it to have an optimised coolant channel with different hole diameters.

Selection includes standard, finishing and roughing coolant clamps with orientations neutral, right and left.

The horizontal orientation angles 0°, 10° and 20° are also available.

A major portion of the ordering code is laser marked on the coolant clamp.

The Jetstream Tooling coolant clamp is designed to have the coolant beam oriented as close as possible to the cutting point, this to get the best effect of the Jetstream coolant and to be able to break or redirect the chips. The APNOM value is a cutting depth indicator we recommend to stay below to get the intended performance.

Changing the insert

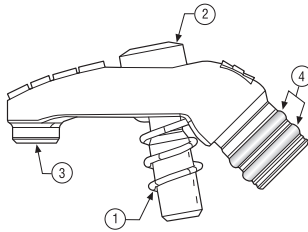

Simply loosen the spring loaded coolant clamp screw.

Change or index the insert. Ensure the coolant clamp pin and the double O-ring are well inside the fixing hole before tightening from the top.

Tighten the screw with recommended torque.

1. Spring
2. Clamp screw
3. Clamp pin
4. O-rings

Changing the O-Rings



After changing the O-rings, ensure that both the Coolant clamp pin & the O-rings are in the correct angle to the fixing hole position before tightening the screws, otherwise it may cause damage to the O-rings.

The double O-rings at the entry point of the Coolant clamps ensures high pressure operational safety up to 200 bars.

JET/ JETL inducer

Holders with this original Jetstream Tooling® innovation will step by step be discontinued however to support earlier investments the inducers will be available to the end of 2024.

Finishing inducer

The mounted Jetstream Tooling® Finishing Inducer gives a universally applicable coolant jet, which provides a well positioned coolant wedge from finishing to medium-roughing applications.

The inducers are marked with “-F” suffix.

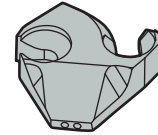

Roughing inducer

As accessories there are Jetstream Tooling® Roughing Inducers available for easy exchange providing a more boosted coolant wedge for clearer roughing applications or for cases demanding more space for the chip flow.

The inducers are marked with “-R” suffix.

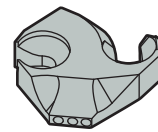

Changing the insert

Simply loosen both locking screws, and rotate the inducer clear of the insert. Check the condition of the tool, screws and O-ring and exchange regularly. Change or index the insert in the standard way before rotating the inducer back into position (make sure the inducer O-ring is still in place) and re-tighten the insert locking screw before locking the inducer.



Jetstream Tooling® Assembly instructions

JETI Assembly instructions with hoses

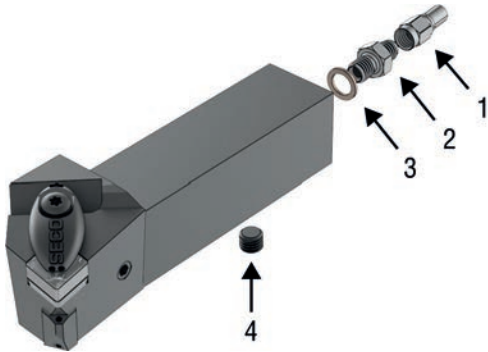

For personal safety, Jetstream Tooling® should only be used with the machine door in a fully closed position in accordance with general machine safety procedures. Please ensure that the coolant hose is located correctly and fully tightened with all seals in position. The unused coolant hose should have a blanking plug fitted.

For accessories, see page(s) 1002.

1. Coolant hose
2. 1/8" BSP Adapter
3. Copper washer
4. Plug

JETI Assembly instructions with adapter



To use the benefits of a JETI-holder there is a need to use toolholder adapter designed for JETI-connections. Maximum coolant pressure when using this feature is limited to the adapter's maximum coolant pressure.

Note: The unused coolant hole (from the back) should have a blanking plug fitted.

Jetstream Tooling® Assembly instructions

JET/ JETL Assembly instructions

Holders with this original Jetstream Tooling® innovation will step by step be discontinued however to support earlier investments the inducers will be available to the end of 2024.

For personal safety, Jetstream Tooling® should only be used with the machine door in a fully closed position in accordance with general machine safety procedures. Please ensure that the coolant hose is located correctly and fully tightened with all seals in position. The unused coolant hole should have a blanking plug fitted. Please note the maximum safe working pressures shown below.

The recommended torque for tightening the inducer locking screw [117.26-655](#) is 4 Nm, see page(s) 1004.



1. Locking screws (can be ordered separately)
2. Coolant inducer
3. Inducer 'O' ring
4. Blanking plug*
5. Copper washer
6. 1/8" BSP Adapter
7. Coolant hose

* Make sure the blanking plug is securely in position in the unused coolant hole prior to use.

Maximum working pressures

Seco-Capto™ – 70 bar (1000 psi)

Square shank – 275 bar (4000 psi)

In the rare cases you need to shut off the Duo outlet underneath the insert, first remove the short screw in the side of the toolholder.

Then mount the long plugging screw [P6SS4X8](#) (02885815) using suitable glue (e.g. Loctite® 270). Plugging the underneath outlet should be considered permanent and irreversible.

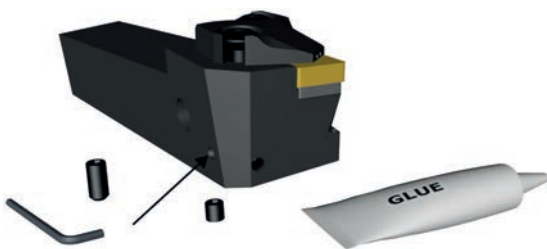

Replace the short screw here with the long screw to shut off underneath coolant

Seco-Capto™ – Introduction

Seco-Capto™ is a quick-change modular tooling system for quick set-up and replacement of the cutting edge.

Advantages

- Quick tool change, increases the available productive time.
 - Flexible, same toolholder can be used in different machines which reduces the tool stock.
 - Modular, building of tools with extension adapters reduces the tool stock.
 - Rigid, no reduction of cutting data.
 - Accurate, tapered polygon coupling produces a strong, self centering joint with repeatability within $\pm 0,002$ mm / 0.000078 inch.
- All toolholders have through holes for coolant.

Seco-Capto™, Cassette holders for Advanced material

The replaceable cassette for PCBN and Ceramic inserts are made out of a special stainless steel with high hardness and high strength. This avoids damage to the pocket which is an otherwise normal occurrence in heavy roughing applications and will also protect the brittle insert.

The centering accuracy and repeatability of the cassette holder are as good as std Seco-Capto™ holders.

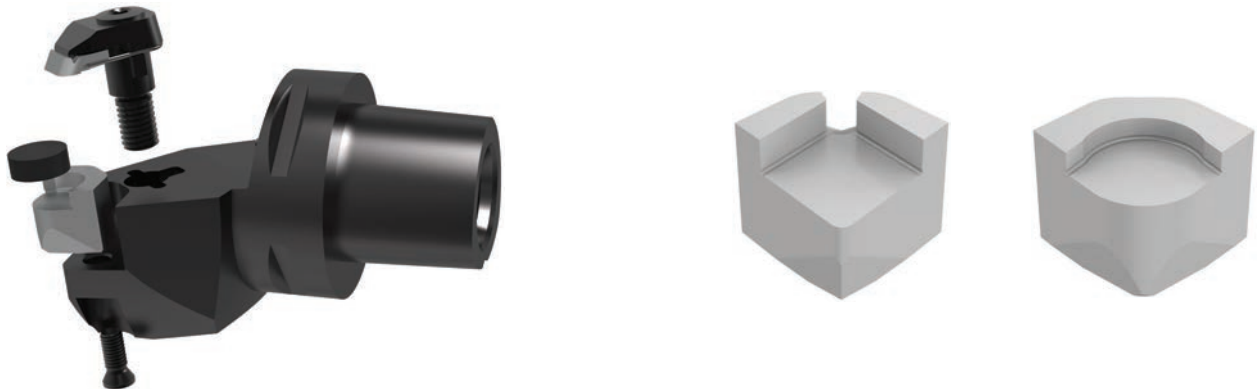

Advantages

- Flexibility and versatility by using different cassettes/ insert types in the same Capto unit will significantly reduce stock volume and net working capital.
- Cost savings as only pockets will need to be exchanged instead of entire holdes when insert pocket damages occur.
- Exceptional process reliability in applications with high risk of extensive tool wear.

Recommended tightening torques for the cassette and clamp

6 Nm

To apply the recommended tightening torque, we recommend to use torque spanners, available as accessories, see MN Tooling Systems catalogue.

Clamping units

The manual clamping units are available in different versions;

- VDI shaft, straight or angled.
- Shank type to use with external toolholders.
- Cylindrical type to use with internal toolholders.
- Versions for special applications.

The unit is locked with a drawbar or screw from the back

Clamping units, please see page(s) 985-996.

Unclamped position

When the drawbar is pushed forward the diameter of the clamping segments decreases and the clamping segments are loosened from the cutting unit. The drawbar also pushes the cutting unit out from the joint.

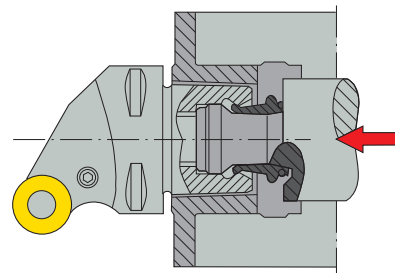

Clamping segments

Clamped position

When the drawbar is pulled back, the diameter of the clamping segments expand and the cutting unit is pulled into position.

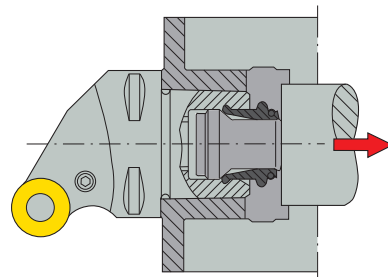

Clamping segments

Steadyliner® vibration damping holders for turning and boring operations

Steadyliner® for tool overhang challenges

Seco's patented Steadyliner® vibration damping holders drastically improve the productivity of the turning assembly.

It allows the use of much higher cutting data, with quieter operation and optimum stability.

They are available in:

- Body diameters $\varnothing 25, 32, 40, 50, 60, 80$ and 100 mm / $\varnothing 0.984, 1.260, 1.575, 1.969, 2.362, 3.150$ and 3.937 inch.
- Lengths 6xD, 8xD and 10xD.
- Seco-Capto™ C4, C5, C6, C8 connections, HSK-T/A 63, HSK-T/A 100.
- Cylindrical shanks-Both in Metric & Inch Sizes.
- With the unique work-piece side connection called GL-Heads in 4 sizes. GL25, GL32, GL40, GL50.
- Flexibility by using same bars for turning and hole making applications.
- Intermediate BA connection for Body diameters $\varnothing 60, 80$ and 100 mm / $\varnothing 2.362, 3.150$ and 3.937 inch.

The Picture shows a Steadyliner bar together with Jet GL-Turning head on a machine.

A Steadyliner bar is one of the most stable solution in the market for tool overhang challenges for reducing vibrations and increasing productivity.



Benefits from increased productivity

Every aspect of Steadyliner® holders has been designed with the consideration for increasing productivity, capacity and machining economy. The design features of the unique GL-Turning heads enhances the steadyline bars to perform & deliver maximum benefits. The Jetstream integrated Jet GL-Heads ensure a cool & steady turning to utmost stability & productivity.

- Increase productivity by increased parameters, surface finish, tool life and vibration free machining
- Reduce head changing down times & insert indexing down times thanks to the unique GL-Heads
- Achieve highly accurate parts with secured surface finish
- Increase selection & less critical spares for maximized versatility
- Increase flexibility by using same bars for turning and boring & same heads for $0^\circ/180^\circ$ turning head orientation
- Control wear, heat & chips with Jetstream Tooling®
- Increased operational safety at high pressures



GL -Turning heads are of different designs.

- Jetstream tooling integrated "Jet GL heads" $\varnothing 32, \varnothing 40$ and $\varnothing 50$.
- Standard GL Heads for $\varnothing 25, \varnothing 32, \varnothing 40$ and $\varnothing 50$.
- Jetstream tooling integrated GL- Grooving/Parting off heads $\varnothing 25, \varnothing 32, \varnothing 40$ and $\varnothing 50$.
- Jetstream tooling integrated GL- Threading heads $\varnothing 25, \varnothing 32, \varnothing 40$ and $\varnothing 50$.



$\varnothing 25$ Steadyliner bars with 10XBD are with carbide re-in forced shanks for maximum stability. GL25-turning heads are not Jetstream tooling integrated and most of them are with positive inserts so as to reduce the deflections to the minimum.

Detailed operating instructions are part of bars delivery content.

For details of GL-Turning Heads for Turning, and MDT, see page(s) 621-659.
For details of GL-Boring heads, see MN Holemaking catalogue.

Note: The Jet GL-Turning heads use a coolant clamp. See Coolant clamp page for more details regarding this in page(s) 86.

General ISO Turning
Technical information

Steadyliner®

MDT

Mini-Shaft™

Grooving

Parting-off

X4

Adapters
Clamping units

Accessories and
Spare parts

Workpiece
materials

Product range and design

Steadyline body diameter	Machine side connections	Working length	BA Connection	GL-Heads	Jetstream Integration	GL-Head styles LH & RH	Inserts
Ø25	C4, C5, C6 HSK-T/A63 Ø25, Ø25.4 (1")	6xBD (Steel) 8xBD (Steel) 10xBD (Carbide reinforced)	–	GL25	–	SCLCx-09, SDUCx-07 & 11, SDXCx-11, SDUCx-11X, STFCx-11, SVUBx-11, SDUNx-11	CC09, DC07, DC11, TC11, VB11, DN11
Ø32	C4, C5, C6, C8 HSK-T/A 63 HSK-T/A100 Ø32, Ø31.8 (1.25")	6xBD (Steel) 8xBD (Steel) 10xBD (Steel)	–	GL32	–	SCLCx-06, 09 & 12, SDUCx-11, SDXCx-11, SDUCx-11X, SDXNx-11, SDUNx-11X, STFCx-16, SVUBx-16, SVUNx-13, DCLNx-12, DDUNx-11 & 15, DWLNx-06 & 08; CTUNx-11, CRSNx-09, CRSNx-09	CC06, CC09, CC12, DC11, TC16, CN12, DN11, VN13, WN06, WN08, TN11, RN09
					GL32...JET	DCLCx-09JET, DDUcX-11JET, DVUBx-16JET, DCLNx-12JET, DDUNx-11JET, DDUNx15JET, DWLNx-06 JET	CC09, DC11, VB16, CN12, DN11, DN15, WN06
Ø40	C5, C6, C8 HSK-T/A 63 HSK-T/A100 Ø40, Ø38.1 (1.5")	6xBD (Steel) 8xBD (Steel) 10xBD (Steel)	–	GL40	–	SCLCx-06, 09 & 12, SDUCx-11, SDXCx-11, SDUCx-11X, SVUBx-16, DDUNx-11 & 15, STFCx-16, DCLNx-12, DWLNx-06 & 08	CC06, CC09, CC12, CN12, DC11, DN11, DN15, TC16, WN06, WN08
					GL40...JET	DCLCx-09JET, DDUcX-11JET, DVUBx-16JET, DCLNx-12 JET, DDUNx-11JET, DDUNx-15JET, DWLNx-06 JET	CC09, DC11, VB16, CN12, DN11, DN15, WN06
Ø50	C6, C8 HSK-T/A 63 HSK-T/A100 Ø50, Ø50.8 (2")	6xBD (Steel) 8xBD (Steel) 10xBD (Steel)	–	GL50	–	SCLCx-06, 09 & 12; SDUCx-11, SDXCx-11, SDUCx-11X, STFCx.16, SUBx-16, DCLNx-12, 16 & 19; DDUNx-15, DWLNx-06 & 08; CCLNx-12	CC06, CC09, CC12, DC11, TC16, CN12, CN16, CN19, DN15, WN06, WN08, CNMN12
Ø60	C6, C8 HSK-T/A100 Ø60, Ø63,5 (2.5")	6xBD (Steel) 8xBD (Steel) 10xBD (Steel)	BA60		GL50...JET	DCLCx-09JET, DDUcX-11JET, DVUBx-16JET, DCLNx-12JET, DDUNx-15JET, DWLNx-06JET	CC09, DC11, VB16, CN12, DN15, WN06
Ø80	C8 HSK-T/A100 Ø80, Ø76.2 (3")	6xBD (Steel) 8xBD (Steel) 10xBD (Steel)	BA80				
Ø100	Ø100, Ø101.6 (4")	10xBD (Steel)	BA100				

Body diameters:
Ø25, 32, 40, 50, 60, 80 and 100 mm / Ø0.984, 1.260, 1.575, 1.969, 2.362, 3.150 and 3.937 inch

Internal turning, Thread-turning, MDT & Boring heads

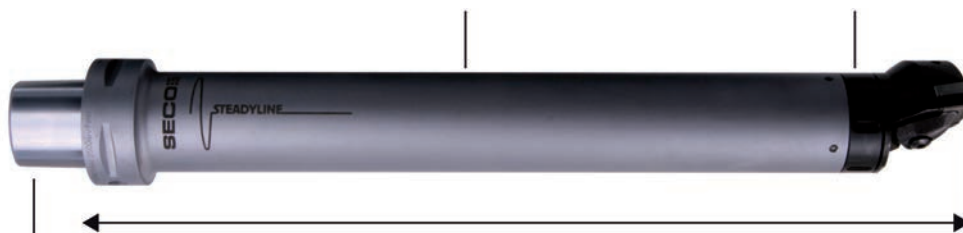

Machine side connections: Seco-Capto™ (C4, C5, C6, C8) & HSK-T/A63, and HSK-T/A100, Cylindrical (Ø25, 32, 40, 50, 60, 80 and 100 mm / Ø0.984, 1.260, 1.575, 1.969, 2.362, 3.150 and 3.937 inch.)

Lengths: 6xD, 8xD, 10xD

GL-Heads: GL25, GL32, GL40 and GL50
Intermediate BA-Connection for Ø60, 80 and 100 mm / 2.362, 3.150 and 3.937 inch

General ISO Turning
Technical information
Steadyline®
MDT
Mini-Shaft™
Grooving
Parting-off
X4
Adapters
Clamping units
Accessories and Spare parts
Workpiece materials

Unique GL-Turning Heads

The patented unique GL-Turning Heads are precisely ground, taper quadrilobe based connection which can be accurately centered & grabbed firm to the Steadyline® bar using the fine pitch threaded clamping nut.

- The centering accuracy and repeatability of the GL-Heads as good as Seco-Capto™.
- Designed for 0°/180° turning head orientation.
- Optimum damping effect through short and compact GL-Heads.
- Wide range of selection of GL-Turning heads, more than 200 GL-Heads available.
- Jet GL-Heads for Integrated Jetstream Tooling® capability.
- Jet GL-Heads are designed with the unique 3D printed coolant clamp.
- Good selection of GL-Head styles, insert sizes & insert shapes.

The compact GL-Turning head preserves the damping strengths of the Steadyline® bars. A Steadyline® bar is one of the most stable solutions in the market for tool overhang challenges for reducing vibrations and increasing productivity.

JET GL-Turning heads

The JET GL-Turning heads further strengthen the solution by integrating the Jetstream Tooling® benefits to the GL-Turning head and in turn to the Steadyline® bar. JET GL-Turning heads use a multifunction coolant clamp for the successful integration.

Advantages

Efficient: Ensures a quick and firm connection and thus decreases the head changing time drastically and increases productivity.

- Flexible: The quadrilobe enables 180 degree orientation of the turning head and hence can be used as left & right hand tools depending on the machining system.
- Accurate: The taper quadrilobe coupling produces a strong self-centering connection with repeatability within $\pm 0,002$ mm at identical conditions.
- Modular: Building different types and styles of Steadyline® bars with suitable GL-Turning heads reduces the inventory.
- Enhances the damping function: The compact and short GL-turning heads are close to the Steadyline® damping mass.
- Jetstream Tooling® gives higher tool life, especially for superalloys and enhances chipbreaking.
- Operational safety: The coolant seal at the backend and the double O-rings of the coolant clamp ensures maximum operational safety up to 200 bars.

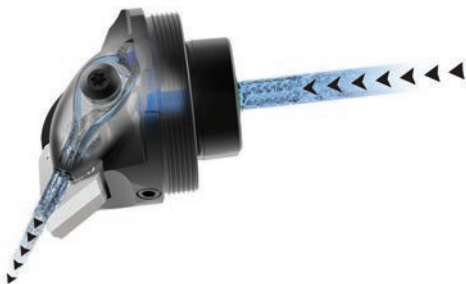

Coolant Seal

General ISO Turning
Technical information

Steadyline®

MDT

Mini-Shaft™

Grooving

Parting-off

X4

Adapters
Clamping units

Accessories and
Spare parts

Workpiece
materials

For GL workpiece side size	Recommended tightening torque
GL25	25 Nm / 221 In/Lbs.
GL32	25 Nm / 221 In/Lbs.
GL40	35 Nm / 310 In/Lbs.
GL50	55 Nm / 487 In/Lbs.



To apply the recommended tightening torque, we recommend to use torque spanners, available as Accessories, see MN Tooling systems catalogue.

BA-Connection allows making use of a wide range of GL50-Heads for Steadyline® bars $\varnothing 60$, $\varnothing 80$, $\varnothing 100$ mm / 2.362, 3.150, 3.937 inch. Each BA-Connection is available in 2 radial offset sizes 'WF' to achieve 2 'f1' reaches, for flexibility over minimum bore diameter & chip space.



First choice: Wide offset WF providing a wider space.

Additional option: Mini offset WF when accessibility is limited.

Steadyline® BA-Connection with Seco-Capto™ and HSK-T/A machine side connections can also be used for rotating boring operations, when fitted.

For detailed information about BA to GL adapters, see page(s) 619-620.

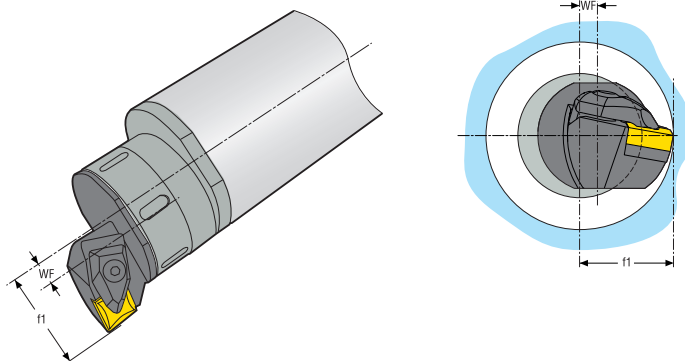

Recommended tightening torques for BA connection screws

For BA workpiece side size	Kit of 4 locking screws	Recommended tightening torque
BA060	90FQ4	11 Nm / 97 In/Lbs.
BA080	90FQ52	16 Nm / 142 In/Lbs.
BA100	90FQ6	23 Nm / 204 In/Lbs.

We recommend to use HC torque spanners, commonly available on the market.

Steadyliner® bars in automatic tool changers

The maximum swinging torque (T) of heavy, long assemblies must be taken into consideration when an automatic tool changers is used to move the bar in the machine. As a first rough estimate comparing the needed swinging torque of a Steadyliner® bar with a specific machine's automatic tool change torque limit, $T_{swinglimit}$, the following simplified formula can be used using only data from the Steadyliner® bar in mind.

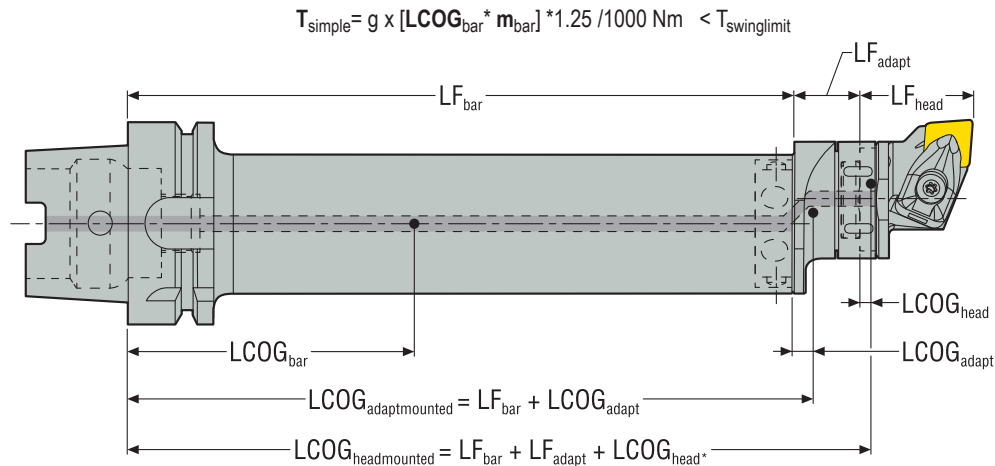

However, it is recommended to consider the swinging torque for the whole assembly by using the following formula.

$$T = \frac{g \times (LCOG_{bar} * m_{bar} + LCOG_{adaptmounted} * m_{adapt} + LCOG_{headmounted} * m_{head})}{1000}$$

T = Maximum swinging torque of the assembly in Nm
m = mass in kg
Lf = functional lengths in mm
LCOG = Positions of the center of gravity in mm

- Notes:
- During tool change, the tool acceleration generates an additional force. It is strongly recommended to slow down the tool changing process if the tool weight or torque is close to the machine limits or to change the tool manually.
 - LCOG, Lf and mass values are available in Product pages. If $LCOG_{adapt} / LCOG_{head}$ is unknown, a good estimation can be obtained by replacing LCOG by respective $\frac{1}{2}$ Lf.

Machine clamping recommendations

Seco's first recommendation for clamping the bars onto the machines is to use bars with Seco-Capto™ machine side connections.

Second choice is the bars with HSK-T/A machine side connections, as both these solutions provide several benefits:

- Maximum stability thanks to the taper-face system and higher bending resistance
- High positioning accuracy of cutting edge, etc.

While using the third choice, the cylindrical bars, Seco strongly recommend to clamp on the marked cylindrical clamping area ensuring the full 4xØ clamping lengths using split sleeves / boring holders.

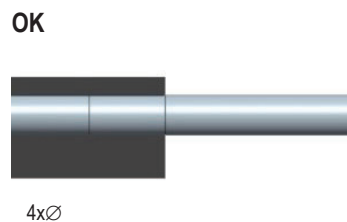
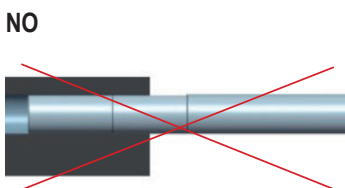

QC Modular Toolholder Introduction

QC Modular Toolholders provide small part machining companies access to benefits seen as given for larger lathes such as:

- Flexible and reduced down-time by fast QC modular head exchange.
- Precise QC modular interface allow for high repeatability
- Jetstream Tooling precise coolant delivery for improved chip control and long predictable tool life
- Multiple heads fit in same shank for greater versatility

Experience these proven solutions for all sliding head machines and see the recommended connections directly under spare parts of the shanks at www.secotools.com.

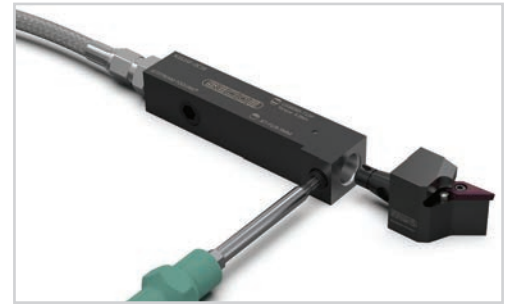

QC Shank adapter to JET-HOSE

Shank 1616 needs only a JET-Hose kit to be connected, all other sizes need also the [JET-ADM8-1.0](#) adapter.

QC Shank adapter to JET-HOSE		QC Shanks
10001981	JET-ADM8-1.0	N03..., N05..., N10..., N12...
-	Included in JET-HOSE kit (JET-AD1/8BSP)	N16...

QC-shank JET-HOSE KITS

"...BB" in the description means Bolt-Bolt connections i.e. on each end of the hose there are threaded interfaces straight with the hose.

"...BS" in the description means Bolt-Swivel connections i.e. on one end there is a threaded interface straight with the hose and on the other there is a 90° interface with free rotation and a separate hollow bolt.

"...SS" in the description means Swivel-Swivel connections i.e. on each end there are 90° interfaces with free rotation and separate hollow bolts.

QC-shank JET-HOSE KITS		Length mm / inch	QC Shank Adapter
02936673	JET-HOSE100BB	100 / 3.937	N16... adapter included
02936674	JET-HOSE100BS	100 / 3.937	N16... adapter included
02936675	JET-HOSE100SS	100 / 3.937	N16... adapter included
02639688	JET-HOSE150BB	150 / 5.906	N16... adapter included
02639688	JET-HOSE150BS	150 / 5.906	N16... adapter included
02639663	JET-HOSE150SS	150 / 5.906	N16... adapter included
02639689	JET-HOSE200BB	200 / 7.874	N16... adapter included
02639682	JET-HOSE200BS	200 / 7.874	N16... adapter included
02639664	JET-HOSE200SS	200 / 7.874	N16... adapter included
02639691	JET-HOSE250BB	250 / 9.843	N16... adapter included
02639684	JET-HOSE250BS	250 / 9.843	N16... adapter included
02639665	JET-HOSE250SS	250 / 9.843	N16... adapter included
02639693	JET-HOSE300BB	300 / 11.811	N16... adapter included
02639686	JET-HOSE300BS	300 / 11.811	N16... adapter included
02639667	JET-HOSE300SS	300 / 11.811	N16... adapter included

General ISO Turning
Technical information

Steadyline®

MDT

Mini-Shaft™

Grooving

Parting-off

X4

Adapters
Clamping units

Accessories and
Spare parts

Workpiece
materials

QC Modular Assembly instructions

QC Modular Toolholder assembly instructions

Assembly the QC toolholder with one screw only, for precise and safe assembly between the head and shank we recommend using a torque of 4.0 Nm (Torque key T00-15P40), for all torque key's available see page(s) 1005.

1. Torque 4.0 Nm

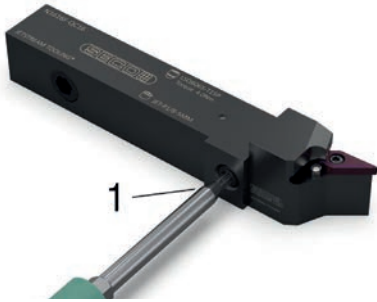

Jetstream Tooling® – Assembly instruction for hoses

For personal safety, Jetstream Tooling® should only be used with the machine door in a fully closed position in accordance with general machine safety procedures. Please ensure that the coolant hose is located correctly and fully tightened with all seals in position. The unused coolant hose should have a blanking plug fitted.

Hoses can be assembled from both the side as well as in the back of the shank. The thread to be use for hose connection varies between different sizes, for 1616 shank the 1/8BSP thread are used and for the smaller shank sizes M8*1.0 thread.

For accessories, see page(s) 1002.

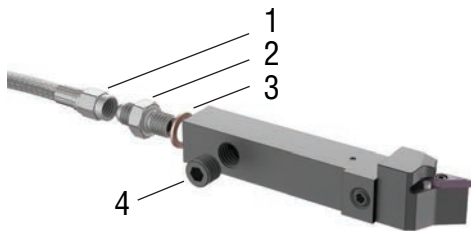

1. Coolant hose
2. Hose dapter
3. Copper washer
4. Plug screw

Jetstream Tooling® Duo

Jetstream Tooling® Duo, available on a selection of cutting heads, adds a second coolant outlet from the clearance side. The second coolant outlet can be shut off if needed for specific applications for even more versatile machining or limitation in coolant supply. To shut off Duo coolant outlet, remove [P6SS3X3G](#) and change to the longer screw [P6SS3X5](#) available as accessories. Important to also use suitable glue to seal the thread (e.g. Loctite® 270).

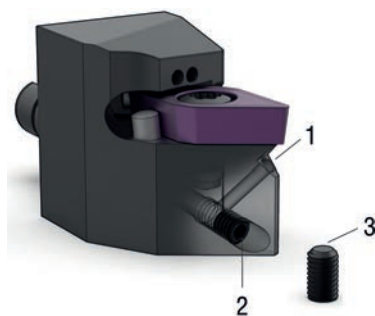

1. Duo Coolant
2. [P6SS3X3G](#)
3. [P6SS3X5](#)

Shims & shim screws for alternate use of DN.1506.. & DN.1504.. Inserts

Toolholder style	Insert	Insert (ANSI)	Shim	Shim (ANSI)	Shim GPN	Shim screw	Shim screw GPN
D-Clamp Toolholders Seco-Capto, GL-heads	DN..1506	DN..44	DDN150416	DDN434	02570509	C04008-T15P	02440234
	DN..1504	DN..43	DDN150616	DDN444	02570508	C04008-T15P	02440234
D-Clamp holders- C4-DDxxx-xx-15-04JETI & C6-DDxxx-xx-15-04JETI	DN..1504	DN..43	DDN150616	DDN444	02570508	C04011-T15P	00040421
	DN..1506	DN..44	DDN150416	DDN434	02570509	C04008-T15P	02440234
D- Clamp Inch holders- DDJxx-xx4x & DDJxx-xx4XJETI	DN..1504	DN..43	DDN150616	DDN444	02570508	C04011-T15P	00040421
	DN..1506	DN..44	DDN150416	DDN434	02570509	C04008-T15P	02440234
D- Clamp Inch holders -DDPxx-xx-4D & DDQxx-xx4D	DN..1504	DN..43	DDN150616	DDN444	02570509	C04008-T15P	00040421
	DN..1506	DN..44	DDN150416	DDN434	02570509	C04008-T15P	02440234
P- Clamp holders	DN..1506	DN..44	PDN150308	PDN422	00039784	LS0822	00039793
	DN..1504	DN..43	PDN150408		02897106	LS0822	00039793
P- Clamp holders C4, C5, C6-PDxxx-xx-15-04JETL	DN..1504	DN..43	PDN150408		02897106	LS0818	00039791
	DN..1506	DN..44	PDN150308	PDN422	00039784	LS0822	00039793
P-clamping bars Sxxx-PDxxx15	DN..1506	DN..44	PDN150308	PDN422	00039784	LS0822	00039793
	DN..1504	DN..43	PDN150408		02897106	LS0822	00039793
Wedge clamping bars, Axxx-PDxxx15	DN..1506	DN..44	PDD150312		74011470	WS2325-T25P	02483615
	DN..1504	DN..43	PDD150412		00084514	WS2325-T25P	02483615
Wedge clamp PDJR4032-15	DN..1506	DN..44	PDN150412		74011060	170.26-655	75009750
Inch holders MDxxx, Axx-MDxxx	DN..1506	DN..44	DSN423	DSN-423	74048118	C04008-T15P	02440234
	DN..1504	DN..43	DSN150412	DSN-433	74072198	C04008-T15P	02440234

Shims & shim screws for alternate use of WN.0804.. & WN.0806.. Inserts

Toolholder style	Insert	Insert (ANSI)	Shim	Shim (ANSI)	Shim GPN	Shim screw	Shim screw GPN
D-Clamp toolholders- Seco-Capto JETI,Seco-Capto, Shank toolholders JETI, Shank toolholders & GL-heads	WN..0804	WN..43	DWN080416	DWN434	02570511	C04008-T15P	02440234
	WN..0806	DN..44	DWN080316	DWN424	02639481	C04008-T15P	02440234
D-Clamp toolholders- Inch	WN..0804	WN..43	DWN080416	DWN434	02570511	C04008-T15P	02440234
	WN..0806	DN..44	DWN080316	DWN424	02639481	C04008-T15P	02440234
D- Clamp boring bars Axxx-DWxxx-C	WN..0804	WN..43	DWD080316		02643406	C04008-T15P	02440234
P- Clamp toolholders-Wedge	WN..0804	WN..43	WAE080412	WAE433	74027939	WS2325-T25P	02483615
	WN..0806	DN..44	WAE080312	WAE423	74037377	WS2325-T25P	02483615
P- Clamp toolholders-Seco-Capto Wedge Clamp	WN..0804	WN..43	WAI080312	WAI423	74027940	WS2325-T25P	02483615
P- Clamp boring bars s Axxx-PW...08	WN..0804	WN..43	WAI080312	WAI423	74027940	WS2325-T25P	02483615
M-clamp toolholders- MW...08	WN..0804	WN..43	MWN080412	IWSN-433	74079689	LD6025-T15P	02483533
	WN..0806	DN..44	MWN080312	IWSN-423	74079690	LD6025-T15P	02483533
M-clamp boring bars Sxx-MW...-4, Sxxx-MW...08, A32-MW...-4	WN..0804	WN..43	MWN080412	IWSN-433	74079689	NL46	00018595
	WN..0806	DN..44	MWN080312	IWSN-423	74079690	NL46L	00048120

General ISO Turning
Technical information

Steadyline®

MDT

Mini-Shaft™

Grooving

Parting-off

X4

Adapters
Clamping units

Accessories and
Spare parts

Workpiece
materials

Small diameter boring – Introduction

Seco offers a range of small diameter boring bars to machine holes as small as 5,5 mm / 0.216". Inserts are available in C and T shape. The toolholders are available in steel and have the possibility for internal through coolant.

Set-up information

When positioned in the machine the insert will sit slightly above centre line. This is a design feature of the tool that compensates for the deflection and improves the machining operation.

When setting the tool in the machine be sure to position it with the flat parallel and in the same plane as the bed of the machine.

The boring bars can be used with or without the cylindrical toolholder sleeve.

Please see page(s) 984.

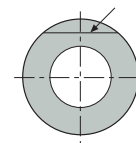
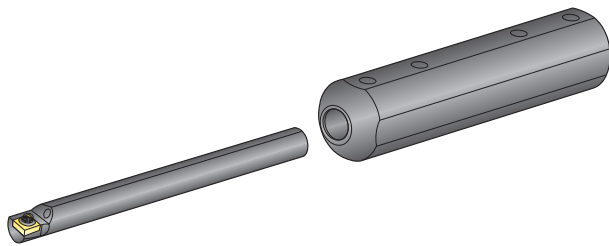

Position flat parallel
with machine bed

General ISO Turning
Technical information

Steadyline®

MDT

Mini-Shaft™

Grooving

Parting-off

X4

Adapters
Clamping units

Accessories and
Spare parts

Workpiece
materials

Cutting data, general

There are several opportunities to adjust and explore cutting data adjustments in www.secotools.com under the Cutting Data section especially when logging in since this unlock option not available as "Guest" For example explore cutting data directly by reading the QR-code.



General ISO Turning
Technical information

Depth of cut

The maximum depth of cut that can be used depends on a number of factors. Machine power, stability, workpiece material, insert shape and size, nose radius, chipbreaker, grade and cutting edge angle.

Start with the insert size to get an indication and proceed with the recommendations for the chosen chipbreaker. This will give a suitable maximum depth of cut.

A rule of thumb could be that the minimum depth of cut should not be smaller than the nose radius.

Feed rate

The maximum feed rate that can be used depends on a number of factors. Machine power, stability, workpiece material, insert shape and size, nose radius, chipbreaker, grade and cutting edge angle.

Another, very important factor is the required surface finish. Start by looking at the recommendations for the chosen chipbreaker. Then look in the surface finish table below to be sure that the required surface finish can be achieved.

The maximum feed rate should preferably be considerably smaller than the nose radius.

A too low feed rate can result in poor chipbreaking and tool life.

Surface finish

A large nose radius normally produces a better surface finish.

The table gives recommended maximum, theoretical, feed rates to achieve a specified R_a -value.

Always consider the possibility to use high feed inserts (Seco Wiper), for turning with high feed with retained surface finish.

For more information, see page(s) 63, 116-118, 129-130.

Note: The refined estimate R_a equation is based on work by J-E Ståhl and gives better surface estimates often indicating potential to increase feeds compared to other estimates.

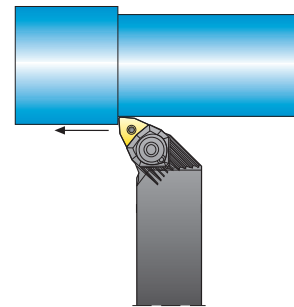
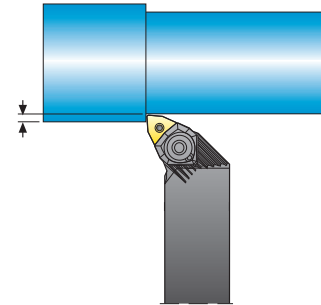

Data according to refined estimate R_a equation

Surface finish R_a value (μm)	Nose radius, RE mm / inch					
	0,2 / 0.008	0,4 / 0.016	0,8 / 0.032	1,2 / 0.047	1,6 / 0.063	2,4 / 0.094
	Feed rate, f mm/ inch / rev					
0,6	0,06 / 0.0023	0,08 / 0.0031	0,12 / 0.0047	0,14 / 0.0055	0,17 / 0.007	0,21 / 0.008
1,6	0,10 / 0.0039	0,14 / 0.0055	0,20 / 0.008	0,24 / 0.009	0,28 / 0.011	0,34 / 0.013
3,2	0,14 / 0.0055	0,20 / 0.008	0,28 / 0.011	0,34 / 0.013	0,39 / 0.015	0,48 / 0.019
6,3	–	0,27 / 0.011	0,39 / 0.015	0,48 / 0.019	0,55 / 0.022	0,68 / 0.027
8,0	–	–	0,44 / 0.017	0,54 / 0.021	0,63 / 0.025	0,77 / 0.030

Steadyline®

MDT

Mini-Shaft™

Grooving

Parting-off

X4

Adapters
Clamping units

Accessories and
Spare parts

Workpiece
materials

Cutting data – Nomenclature and formulae

RPM	$n = \frac{v_c \cdot 1000}{\pi \cdot D_c}$	(rev/min)
Cutting speed	$v_c = \frac{n \cdot \pi \cdot D_c}{1000}$	(m/min)
Surface finish (arithmetic average deviation) Rough estimates	$R_a = \frac{f^2 \cdot 50}{RE}$	(μm)
	$R_a = \frac{R_t}{3,5}$	(μm)
Refined estimate	$R_a \approx 770 \cdot \left(1 - \frac{\frac{f}{2RE}}{\arcsin\left(\frac{f}{2RE}\right)}\right) \cdot RE (\mu\text{m})$	
	Valid for:	
	$f \leq 2 \sqrt{a_p (2RE - a_p)} \leq 2RE$	
	see note and table in page(s) 101	
Surface finish total height of profile estimate	$R_t = k \cdot \frac{f^2 \cdot 1000}{8 \cdot RE}$	(μm)
Power demand estimate	$P_c = \frac{v_c \cdot f \cdot a_p}{25}$	(kW)
Metal removal rate	$Q = v_c \cdot f \cdot a_p$	(cm^3/min)

a_p	= Depth of cut	(mm)
DC	= Workpiece diameter	(mm)
f	= Feed rate	(mm/rev)
h	= Chip thickness	(mm)
k	= Constant = 1,0 for steel and stainless steel 1,4 for cast iron	
n	= RPM	(rev/min)
P_c	= Power demand	(kW)
Q	= Metal removal rate	(cm^3/min)
R_a	= Surface finish (arithmetic average deviation)	(μm)
RE	= Nose radius	(mm)
R_t	= Total height of profile surface	(μm)
v_c	= Cutting speed	(m/min)

General ISO Turning
Technical information

Steadyline®

MDT

Mini-Shaft™

Grooving

Parting-off

X4

Adapters
Clamping units

Accessories and
Spare parts

Workpiece
materials

Cutting data, workpiece materials



In SMG classification of workpiece materials involves a specific material standard in a specific condition assigned as reference for easy and unambiguous adjustment of cutting data for any actual material compared to any Seco reference material. As examples the reference materials EN C45E for SMG P4 and EN 42 CrMo 4 for both SMG P5 and SMG H5 shown below in table 1 where the reference level material property is indicated. (A more complete extract can be found on SMG section starting page 1006.

SMG	Description	Properties	Reference	SMG	Description	Properties	Reference
P4	Low-alloy general structural steels, 0.25% < C < 0.67%wt Low-alloy Quench & Temper steels	520 < R _m < 1200	C 45E R _m = 660 N/mm ²	H5	Quenched & Tempered steels	38 < HRC < 56	42 CrMo 4 50 HRC
P5	Structural steels, 0.25% < C < 0.67%wt Quench & Temper steels	550 < R _m < 1200	42 CrMo 4 R _m = 700 N/mm ²				

Focusing specifically on EN 42 CrMo 4 in annealed condition, the ultimate tensile strength R_m may typically vary between R_m = 630 N/mm² and R_m = 780 N/mm², which provide a referencing level for SMG P5. In Quenched & Tempered condition, the ultimate tensile strength R_m may typically be between R_m = 900 N/mm² and R_m = 1100 N/mm² thus still belongs to SMG P5. However, if hardened above R_m = 1200 N/mm² it instead belongs to SMG H5.

SMG	EN	W.-Nr	AFNOR	BS	UNI	JIS	AISI / ASTM	GOST	Condition	R _m nom	HRC nom
P5	42 CrMo 4	1.1201	42 CD 4	708 M 40	42 CrMo 4	SCM 440 (H)	4142, 4140	38HM	Annealed	700	
	42 CrMo 4	1.1201	42 CD 4	708 M 40	42 CrMo 4	SCM 440 (H)	4142, 4140	38HM	Quenched & Tempered	1000	
H5	42 CrMo 4	1.1201	42 CD 4	708 M 40	42 CrMo 4	SCM 440 (H)	4142, 4140	38HM	Quenched & Tempered		45
	42 CrMo 4	1.1201	42 CD 4	708 M 40	42 CrMo 4	SCM 440 (H)	4142, 4140	38HM	Quenched & Tempered		50

The EN 42CrMo4 quench & tempered steel could be used to illustrate the machinability dependence of materials' condition.

The graphs below indicate how speed recommendations for a nominal material conditions may be adjusted for relative R_m (left diagram valid for ISO-P) and for relative HRC (valid for ISO-H).

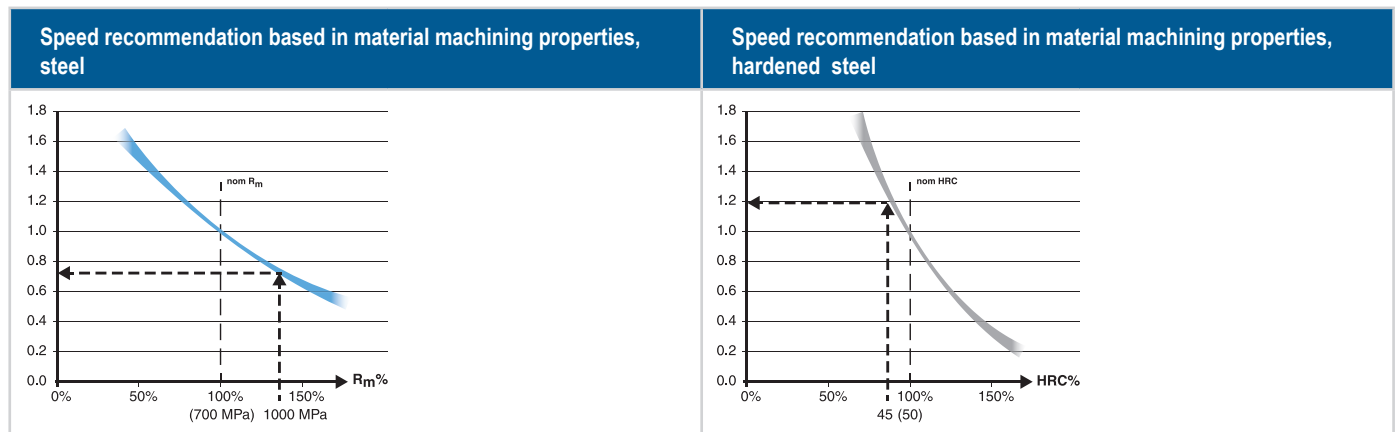

To further illustrate how the SMG P5 nominal v_c can be adjusted to a more accurate recommended v_c we need ultimate tensile strength R_m data and in this case we use the EN 42 CrMo 4 quenched & tempered to R_m = 1000 N/mm² according to above table (bold blue arrows).

Assume that we find that the SMG P5 nominal v_c = 280 m/min / 918.64 sfm for a certain product and machining.

Then, actual recommended v_c = 280 m/min x 0,75 = 210 m/min / v_c = 918.64 sfm x 0.75 = 688.98 sfm.

Consequently in the SMG H5 the nominal v_c can be adjusted using the hardened EN 42 CrMo 4 at HRC 45 (smaller grey arrows).

Assume that the SMG H5 nominal v_c = 50 m/min / 164.04 sfm for a certain product and machining using a coated cemented carbide tools then, actual recommended v_c = 50 m/min x 1,2 = 60 m/min.

Note that when using PCBN tools cutting data recommendation starts at page(s) 138.

For further workpiece material details please see page(s) 1006 and suggested cutting data at applicable pages.

For more convenient cutting data handling we recommend applicable tools in My Pages – on www.secotools.com

These cutting data compensations for steels are fully implemented at www.secotools.com in MyPages (see QR-code in the upper right corner).

General ISO Turning
Technical information
Steadyline®
MDT
Mini-Shaft™
Grooving
Parting-off
X4
Adapters
Clamping units
Accessories and
Spare parts
Workpiece
materials

Cutting data



Cutting speed v_c (m/min)

In this section a recommended cutting speed is indicated under specified conditions and a selected SMG.

Use the tables beginning on page(s) 1006 to classify the workpiece material into a SMG.

In order to increase the accuracy towards the actual cutting conditions and requirements of the applications the recommendation is to use Seco MyPages, Suggest or explore www.secotools.com (see QR-code in the upper right corner).

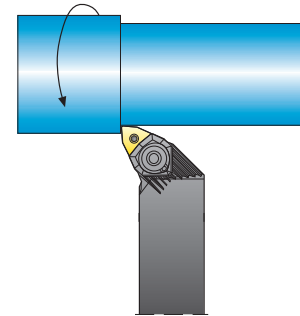

KAPR = cutting edge angle (°) (from holder)

RE = nose radius (mm / inch)

a_p = depth of cut (mm / inch)

f = feed rate (mm/rev / inch/rev)

Representative insert: CCMT09T304-MF2 / CCMT32.51-MF2

Tool life = 15 min

$a_p = 1 \text{ mm} / 0.040 \text{ Inch}$

Holder: SCLCL1212M09

SMG	TP1501 f (mm/r) (in/rev)			TP2501 f (mm/r) (in/rev)			TP3501 f (mm/r) (in/rev)			CP500 f (mm/r) (in/rev)			TM1501 f (mm/r) (in/rev)		
	0,15 0.006	0,2 0.008	0,25 0.010	0,15 0.006	0,2 0.008	0,25 0.010	0,15 0.006	0,2 0.008	0,25 0.010	0,15 0.006	0,2 0.008	0,25 0.010	0,15 0.006	0,2 0.008	0,25 0.010
P1	820	750	700	680	640	600	710	640	580	295	265	250	530	490	450
	2650	2450	2300	2225	2075	1975	2300	2075	1900	950	870	800	1750	1600	1475
P2	790	730	680	560	580	580	690	620	570	285	260	240	520	475	440
	2600	2400	2225	1825	1900	1900	2225	2025	1825	940	850	790	1700	1550	1425
P3	530	530	520	580	600	590	450	420	395	245	225	210	445	410	380
	1750	1750	1700	1900	1975	1925	1450	1375	1300	800	740	670	1450	1325	1225
P4	600	560	520	500	470	440	520	470	430	215	195	185	390	360	335
	1975	1800	1675	1650	1550	1450	1700	1550	1400	710	640	590	1275	1175	1075
P5	445	445	435	410	425	425	375	355	335	205	190	175	375	345	320
	1450	1450	1425	1350	1400	1375	1225	1150	1075	670	610	570	1225	1125	1025
P6	640	600	550	540	500	475	560	500	460	230	210	195	420	385	355
	2100	1925	1800	1775	1650	1550	1825	1650	1500	750	690	640	1375	1275	1175
P7	475	475	460	370	400	410	400	375	355	220	200	185	395	365	335
	1550	1550	1500	1225	1300	1350	1300	1225	1150	720	660	610	1300	1175	1100
P8	445	445	435	410	425	425	375	355	335	205	190	175	375	345	320
	1450	1450	1425	1350	1400	1375	1225	1150	1075	670	610	570	1225	1125	1025
P11	460	460	445	280	310	320	285	295	285	275	235	200	310	295	275
	1500	1500	1450	920	1025	1050	940	970	940	900	750	640	1025	950	900
P12	270	270	265	165	180	190	170	175	170	125	115	105	185	175	160
	890	890	870	540	610	620	560	570	560	410	375	345	610	560	520

Representative insert: CCMT09T304-MF2 / CCMT32.51-MF2

Tool life = 15 min

$a_p = 1 \text{ mm} / 0.040 \text{ Inch}$

Holder: SCLCL1212M09

SMG	TP1030 f (mm/r) (in/rev)			TP1020 f (mm/r) (in/rev)			TP25 f (mm/r) (in/rev)		
	0,1 0.004	0,2 0.008	0,25 0.01	0,1 0.004	0,2 0.008	0,25 0.01	0,1 0.004	0,2 0.008	0,25 0.01
P1	560	445	400	350	235	200	600	500	465
	1800	1450	1300	1150	750	640	1975	1650	1525
P2	540	430	390	340	230	195	580	490	455
	1775	1400	1275	1125	740	620	1900	1600	1475
P3	465	370	335	295	195	165	500	420	390
	1525	1225	1075	950	640	540	1650	1375	1275
P4	410	325	295	260	170	145	445	370	345
	1350	1075	950	840	560	475	1450	1225	1125
P5	390	310	280	245	165	140	425	355	330
	1275	1025	920	800	540	460	1375	1150	1075
P6	440	350	315	280	185	155	475	395	370
	1450	1150	1025	900	610	510	1550	1300	1200
P7	415	330	300	260	175	150	450	375	350
	1350	1075	970	850	560	475	1450	1225	1125
P8	390	310	280	245	165	140	425	355	330
	1275	1025	920	800	540	460	1375	1150	1075
P11	270	190	165	245	170	145	285	280	265
	890	620	540	800	560	475	940	920	870
P12	160	110	95	145	100	85	165	165	155
	520	360	310	475	330	280	560	540	510

Representative insert: CNMG120408-M3 / CNMG432-M3

Tool life = 15 min

$a_p = 2,5 \text{ mm} / 0.100 \text{ Inch}$

Holder: DCLNR2525M12-M

SMG	TP0501 f (mm/r) (in/rev)			TP1501 f (mm/r) (in/rev)			TP2501 f (mm/r) (in/rev)			TP3501 f (mm/r) (in/rev)			TP25 f (mm/r) (in/rev)		
	0,2 0.008	0,3 0.012	0,4 0.016	0,2 0.008	0,3 0.012	0,4 0.016	0,2 0.008	0,3 0.012	0,4 0.016	0,2 0.008	0,3 0.012	0,4 0.016	0,2 0.008	0,3 0.012	0,4 0.016
P1	780	690	610	690	590	510	590	510	450	580	480	410	465	395	345
	2550	2275	1975	2275	1900	1675	1925	1675	1450	1900	1550	1325	1500	1275	1125
P2	760	670	590	680	570	495	560	520	460	570	465	400	450	385	335
	2500	2200	1925	2200	1875	1625	1800	1675	1500	1825	1525	1300	1475	1250	1100
P3	620	590	510	500	450	400	570	530	465	390	340	300	390	330	290
	2025	1900	1675	1650	1475	1300	1875	1700	1525	1275	1100	970	1275	1075	950
P4	580	510	450	510	435	375	435	375	330	430	355	300	340	290	255
	1875	1675	1450	1675	1400	1225	1425	1225	1075	1400	1150	980	1125	950	840
P5	520	495	435	420	380	335	405	375	330	325	285	250	325	280	245
	1700	1600	1400	1375	1250	1075	1325	1225	1075	1075	940	820	1075	900	790
P6	620	550	480	550	465	405	465	405	355	460	380	325	365	310	275
	2025	1775	1575	1800	1500	1300	1525	1300	1175	1500	1225	1050	1200	1025	890
P7	550	520	460	445	405	355	390	380	350	345	300	265	345	295	260
	1800	1700	1500	1450	1300	1150	1275	1250	1125	980	870	770	1125	950	840
P8	520	495	435	420	380	335	405	375	330	325	285	250	325	280	245
	1700	1600	1400	1375	1250	1075	1325	1225	1075	1075	940	820	1075	900	790
P11	540	510	445	435	390	345	300	295	270	275	240	200	265	230	195
	1775	1650	1450	1425	1275	1125	980	970	870	900	790	660	870	740	640
P12	315	300	265	255	230	205	175	175	160	165	145	120	155	135	115
	1025	980	850	840	750	660	590	570	510	540	460	395	510	445	375

Representative insert: CNMG190616-MR7 / CNMG644-MR7

Tool life = 15 min

$a_p = 6 \text{ mm} / 0.240 \text{ Inch}$

Holder: DCLNR4040R19-M

SMG	TP0501 f (mm/r) (in/rev)			TP1501 f (mm/r) (in/rev)			TP2501 f (mm/r) (in/rev)			TP3501 f (mm/r) (in/rev)			TP25 f (mm/r) (in/rev)			TP40 f (mm/r) (in/rev)		
	0,4 0.016	0,55 0.022	0,7 0.028	0,4 0.016	0,55 0.022	0,7 0.028	0,4 0.016	0,55 0.022	0,7 0.028	0,4 0.016	0,55 0.022	0,7 0.028	0,4 0.016	0,55 0.022	0,7 0.028	0,4 0.016	0,55 0.022	0,7 0.028
P1	590	480	400	490	405	340	435	365	315	390	315	265	335	280	240	235	190	155
	1900	1550	1300	1600	1300	1125	1400	1175	1025	1275	1025	850	1075	900	790	750	610	510
P2	570	465	385	480	395	335	440	350	285	380	305	255	325	270	235	230	185	155
	1875	1500	1250	1550	1275	1075	1425	1125	920	1225	1000	840	1050	890	770	740	590	490
P3	490	375	290	385	310	250	450	355	285	290	245	210	280	235	200	195	155	130
	1600	1225	940	1250	1000	820	1450	1150	920	940	790	690	900	750	660	640	510	425
P4	430	355	295	360	295	250	320	270	230	290	230	195	245	205	180	170	140	115
	1400	1150	950	1175	970	820	1050	870	750	940	750	620	800	670	570	560	445	375
P5	415	315	245	320	260	210	315	245	195	245	205	175	235	195	170	165	130	110
	1350	1025	790	1050	840	690	1025	800	620	790	670	570	770	640	560	540	425	360
P6	465	380	315	390	320	270	345	290	250	310	250	210	265	220	190	185	150	125
	1500	1225	1025	1275	1025	890	1125	940	800	1000	800	670	850	720	620	610	475	410
P7	435	335	260	340	275	225	335	275	225	260	215	190	250	210	180	175	140	115
	1425	1075	840	1125	890	720	1100	900	740	840	710	610	800	670	590	570	460	375
P8	415	315	245	320	260	210	315	245	195	245	205	175	235	195	170	165	130	110
	1350	1025	790	1050	840	690	1025	800	620	790	670	570	770	640	560	540	425	360
P11	425	325	250	330	265	220	260	210	165	190	140	100	185	145	120	100	85	75
	1375	1050	800	1075	870	710	840	670	540	620	445	330	610	475	375	330	280	245
P12	250	190	150	195	155	130	155	125	100	110	80	60	110	85	70	60	50	46
	820	620	475	640	510	410	490	395	310	360	260	195	360	280	230	195	165	150

Representative insert: CNMG120408-MF2 / CNMG432-MF2

Tool life = 15 min

$a_p = 1,5 \text{ mm} / 0.060 \text{ Inch}$

Holder: DCLNR2525M12-M

SMG	TH1000 f (mm/r) (in/rev)		
	0,1 0.004	0,25 0.010	0,4 0.016
H3	90	70	55
	295	230	180
H5	170	125	100
	560	410	330
H7	90	70	55
	295	230	180
H8	170	125	100
	560	410	330
H11	215	160	130
	710	520	410
H12	200	150	115
	660	475	375
H21	170	125	100
	560	410	330

General ISO Turning
Technical information

Steadyline®

MDT

Mini-Shaft™

Grooving

Parting-off

X4

Adapters
Clamping units

Accessories and
Spare parts

Workpiece
materials

Representative insert: CCMT09T308-MF2 / CCMT32.52-MF2

Tool life = 10 min

$a_p = 1 \text{ mm} / 0.040 \text{ Inch}$

Holder: C4-SCLCR-13080-09

SMG	TM1501 f (mm/r) (in/rev)			TM2501 f (mm/r) (in/rev)			TM3501 f (mm/r) (in/rev)			CP500 f (mm/r) (in/rev)			TP25 f (mm/r) (in/rev)		
	0,1 0.004	0,2 0.008	0,3 0.012	0,1 0.004	0,2 0.008	0,3 0.012	0,1 0.004	0,2 0.008	0,3 0.012	0,1 0.004	0,2 0.008	0,3 0.012	0,1 0.004	0,2 0.008	0,3 0.012
P4	485 1575	415 1350	365 1175	—	—	—	—	—	—	280 900	225 740	195 640	495 1600	425 1375	375 1225
M1	400 1300	380 1250	345 1125	400 1300	335 1100	290 940	395 1300	335 1075	285 940	430 1400	335 1075	255 820	335 1100	355 1150	325 1075
M2	325 1075	310 1025	275 900	325 1050	270 890	235 750	320 1050	270 890	230 750	350 1125	270 890	205 660	270 890	285 940	265 850
M3	245 800	235 770	210 690	245 800	205 670	180 570	245 800	205 670	175 570	265 870	205 670	155 510	205 670	215 710	200 660
M4	—	—	—	175 570	160 520	155 510	200 640	180 590	160 520	200 660	155 510	115 375	135 445	125 410	120 375
M5	—	—	—	145 475	135 445	130 410	165 540	150 490	130 425	165 540	130 410	95 310	115 375	105 345	100 330

Representative insert: CNMG120408-MF4 / CNMG432-MF4

Tool life = 10 min

$a_p = 3 \text{ mm} / 0.120 \text{ Inch}$

Holder: PCLNL2020K12JETL

SMG	TM1501 f (mm/r) (in/rev)			TM2501 f (mm/r) (in/rev)			TM3501 f (mm/r) (in/rev)			CP500 f (mm/r) (in/rev)			TP25 f (mm/r) (in/rev)		
	0,2 0.008	0,3 0.012	0,4 0.016	0,2 0.008	0,3 0.012	0,4 0.016	0,2 0.008	0,3 0.012	0,4 0.016	0,2 0.008	0,3 0.012	0,4 0.016	0,2 0.008	0,3 0.012	0,4 0.016
P4	390 1275	330 1075	290 940	—	—	—	—	—	—	210 690	180 590	160 520	370 1200	315 1025	275 900
M1	370 1200	315 1025	270 870	315 1025	260 840	220 720	310 1025	255 820	215 710	285 920	195 620	140 460	320 1025	275 890	235 750
M2	300 970	255 820	220 710	255 820	210 690	180 590	250 820	205 670	175 570	230 740	155 510	115 360	255 840	220 720	190 610
M3	225 740	195 620	165 540	190 620	160 520	135 445	190 620	155 510	135 425	175 570	120 395	85 280	195 640	170 540	145 460
M4	—	—	—	160 520	150 490	140 460	170 560	145 475	125 410	130 425	90 295	65 215	115 375	105 345	100 330
M5	—	—	—	135 445	125 410	120 395	140 460	120 395	105 345	110 360	75 245	55 180	95 310	90 295	85 280

Representative insert: CCMT09T308-M5 / CCMT32.52-M5

Tool life = 15 min

$a_p = 1 \text{ mm} / 0.040 \text{ Inch}$

Holder: C4-SCLCL-17090-09

SMG	TK0501 f (mm/r) (in/rev)			TK1501 f (mm/r) (in/rev)			TP1501 f (mm/r) (in/rev)			TP0501 f (mm/r) (in/rev)		
	0,2 0.008	0,3 0.012	0,4 0.016	0,2 0.008	0,3 0.012	0,4 0.016	0,2 0.008	0,3 0.012	0,4 0.016	0,2 0.008	0,3 0.012	0,4 0.016
K1	600 1975	560 1800	520 1700	530 1750	475 1550	440 1450	455 1500	470 1550	460 1500	485 1600	495 1625	490 1600
K2	465 1525	435 1425	415 1350	455 1475	420 1375	400 1300	395 1300	405 1325	400 1300	420 1375	430 1400	425 1400
K3	395 1275	370 1200	350 1150	385 1275	355 1175	340 1100	335 1100	345 1125	340 1125	355 1175	365 1200	360 1175
K4	375 1225	350 1150	335 1100	365 1200	340 1125	325 1050	320 1050	330 1075	325 1075	340 1125	350 1150	345 1125
K5	225 720	210 690	200 660	220 710	205 660	190 620	190 620	195 640	195 620	200 660	205 670	205 670
K6	375 1225	345 1125	320 1050	325 1075	295 970	270 890	280 920	290 950	285 940	300 980	305 1000	305 980
K7	285 940	265 870	255 840	280 920	260 850	245 800	245 800	250 820	245 800	255 850	265 870	260 850

General ISO Turning
Technical information

Steadyline®

MDT

Mini-Shaft™

Grooving

Parting-off

X4

Adapters
Clamping units

Accessories and
Spare parts

Workpiece
materials

Representative insert: **CNMG120412-MR7 / CNMG433-MR7**

Tool life = 15 min

$a_p = 3 \text{ mm} / 0.120 \text{ Inch}$

Holder: A40U-PCLNL12

SMG	TK0501 f (mm/r) (in/rev)			TK1501 f (mm/r) (in/rev)			TP1501 f (mm/r) (in/rev)			TP25 f (mm/r) (in/rev)		
	0,2 0.008	0,35 0.014	0,5 0.020	0,2 0.008	0,35 0.014	0,5 0.020	0,2 0.008	0,35 0.014	0,5 0.020	0,2 0.008	0,35 0.014	0,5 0.020
P4	—	—	—	—	—	—	520	410	340	345	275	230
K1	570	495	455	480	405	355	450	435	405	465	365	305
	1825	1625	1475	1575	1300	1175	1475	1425	1300	1500	1200	1000
K2	420	380	355	420	375	345	390	380	350	400	320	265
	1375	1250	1150	1350	1225	1125	1275	1225	1150	1300	1025	870
K3	355	320	300	355	315	290	330	320	295	340	270	225
	1175	1050	980	1175	1025	950	1075	1050	970	1125	870	740
K4	340	305	285	340	300	280	315	305	280	325	255	215
	1125	1000	940	1100	980	900	1025	1000	920	1050	840	710
K5	205	180	170	200	180	165	185	180	170	—	—	—
	660	590	560	660	590	540	610	590	540	—	—	—
K6	350	305	280	295	250	220	275	270	250	—	—	—
	1150	1000	920	970	820	720	900	890	800	—	—	—
K7	260	235	215	260	230	210	240	235	215	—	—	—
	850	770	710	840	750	690	790	750	710	—	—	—

Representative insert: **CCGT060204F-AL / CCGT21.51F-AL**

Tool life = 15 min

$a_p = 1 \text{ mm} / 0.040 \text{ Inch}$

Holder: A10L-SCLCR06

SMG	KX f (mm/r) (in/rev)			CP500 f (mm/r) (in/rev)			TP25 f (mm/r) (in/rev)		
	0,1 0.004	0,15 0.006	0,2 0.008	0,1 0.004	0,15 0.006	0,2 0.008	0,1 0.004	0,15 0.006	0,2 0.008
P3	—	—	—	280	245	225	510	460	425
	—	—	—	900	800	740	1675	1500	1375
M3	—	—	—	235	200	170	205	210	205
	—	—	—	770	660	540	670	690	670
K3	—	—	—	265	230	205	435	395	365
	—	—	—	870	750	670	1425	1300	1175
N3	330	290	265	—	—	—	—	—	—
	1075	950	870	—	—	—	—	—	—
N11	375	335	305	215	190	170	—	—	—
	1225	1075	980	690	620	560	—	—	—
S3	—	—	—	27	24	22	—	—	—
	—	—	—	90	80	70	—	—	—

Representative insert: **CCMT09T304-F1 / CCMT32.51-F1**

Tool life = 10 min

$a_p = 1 \text{ mm} / 0.040 \text{ Inch}$

Holder: C4-SCLCR-27050-09JET

SMG	TS2000 f (mm/r) (in/rev)			CP200 f (mm/r) (in/rev)			CP500 f (mm/r) (in/rev)		
	0,08 0.003	0,15 0.006	0,2 0.008	0,08 0.003	0,15 0.006	0,2 0.008	0,08 0.003	0,15 0.006	0,2 0.008
S1	90	70	60	48	40	36	42	35	32
	295	215	180	160	130	120	140	115	100
S2	70	55	47	39	32	29	36	30	27
	245	180	150	130	105	95	120	100	90
S3	60	47	40	33	28	25	31	26	24
	215	155	130	110	90	80	105	85	80
S11	130	100	85	70	60	55	—	—	—
	425	310	280	230	195	165	—	—	—
S12	100	75	65	55	44	41	—	—	—
	330	245	215	180	145	130	—	—	—
S13	75	60	50	41	34	31	—	—	—
	260	195	160	140	110	100	—	—	—

General ISO Turning
Technical information

Steadyline®

MDT

Mini-Shaft™

Grooving

Parting-off

X4

Adapters
Clamping units

Accessories and
Spare parts

Workpiece
materials

Representative insert: **CNMG120408-MF1 / CNMP432-MF1**

Tool life = 10 min

$a_p = 1,5 \text{ mm} / 0.060 \text{ Inch}$

Holder: C6-DCLNR-45065-12JETI

SMG	TS2000 f (mm/r) (in/rev)			CP200 f (mm/r) (in/rev)			890 f (mm/r) (in/rev)			CP500 f (mm/r) (in/rev)			TH1000 f (mm/r) (in/rev)		
	0,1 0.004	0,2 0.008	0,3 0.012	0,1 0.004	0,2 0.008	0,3 0.012	0,1 0.004	0,2 0.008	0,3 0.012	0,1 0.004	0,2 0.008	0,3 0.012	0,1 0.004	0,2 0.008	0,3 0.012
S1	80	55	43	44	35	31	40	33	28	38	31	27	105	75	55
	260	180	140	145	115	100	130	105	90	125	100	85	345	245	180
S2	65	46	35	36	29	25	33	26	23	33	27	23	85	60	45
	215	150	115	115	90	80	105	85	75	110	90	75	280	195	150
S3	55	39	30	31	25	21	28	23	20	29	23	20	75	50	39
	180	130	100	100	80	70	90	70	60	95	75	65	245	165	130
S11	115	80	65	65	50	44	60	47	41	—	—	—	150	105	80
	375	260	195	215	165	145	195	155	130	—	—	—	490	345	260
S12	90	65	48	49	39	34	45	36	31	—	—	—	115	80	65
	295	195	155	160	130	110	150	120	100	—	—	—	375	260	195
S13	70	49	37	38	31	26	35	28	24	—	—	—	90	65	49
	230	155	120	125	100	85	115	90	80	—	—	—	295	215	155

Representative insert: **CNMG120412-MR4 / CNMG433-MR4**

Tool life = 10 min

$a_p = 3 \text{ mm} / 0.120 \text{ Inch}$

Holder: C8-DCLNR-55080-12JETI

SMG	TS2500 f (mm/r) (in/rev)			883 f (mm/r) (in/rev)		
	0,2 0.008	0,3 0.012	0,45 0.018	0,2 0.008	0,3 0.012	0,45 0.018
S1	47	35	25	25	22	18
	155	115	80	80	70	60
S2	38	29	21	20	17	15
	125	90	65	65	55	49
S3	33	25	18	18	15	13
	110	80	55	55	49	43
S11	70	50	37	36	31	26
	230	165	120	120	100	85
S12	55	39	28	28	24	20
	165	130	90	90	80	65
S13	41	31	22	22	19	16
	130	100	70	70	60	50

General ISO Turning
Technical information

Steadyline®

MDT

Mini-Shaft™

Grooving

Parting-off

X4

Adapters
Clamping units

Accessories and
Spare parts

Workpiece
materials

Representative insert: LNMX191940-MR / LNMX191940-MR

Tool life = 60 min

$a_p = 3 \text{ mm} / 0.120 \text{ Inch}$

Holder: CT-PLANL3223-19

SMG	TP0501 f (mm/r) (in/rev)			TP1501 f (mm/r) (in/rev)			TP25 f (mm/r) (in/rev)		
	0,5 0.024	0,9 0.035	1,3 0.051	0,5 0.024	0,9 0.035	1,3 0.051	0,5 0.024	0,9 0.035	1,3 0.051
P4	290	190	135	250	165	125	195	140	110
	840	620	445	720	540	410	570	460	360

Representative insert: RCMX250700-R3 / RCMX250700-R3

Tool life = 60 min

$a_p = 5 \text{ mm} / 0.200 \text{ Inch}$

Holder: PRDCN4040S25

SMG	TP0501 f (mm/r) (in/rev)			TP1501 f (mm/r) (in/rev)		
	0,6 0.023	1 0.039	1,4 0.055	0,6 0.023	1 0.039	1,4 0.055
P4	315	220	165	275	195	145
	1050	740	540	920	640	475

Representative insert: RCMX250700-RR93 / RCMX250700-RR93

Tool life = 45 min

$a_p = 3 \text{ mm} / 0.120 \text{ Inch}$

Holder: PRDCN4040S25

SMG	TP0501 f (mm/r) (in/rev)			TP1501 f (mm/r) (in/rev)			TP2501 f (mm/r) (in/rev)			TP25 f (mm/r) (in/rev)		
	0,6 0.023	0,9 0.035	1,2 0.047	0,6 0.023	0,9 0.035	1,2 0.047	0,6 0.023	0,9 0.035	1,2 0.047	0,6 0.023	0,9 0.035	1,2 0.047
P7	380	315	250	300	245	205	280	250	210	190	165	145
	1250	1025	820	1000	820	670	940	820	690	640	540	475

Representative insert: SNMM250724-R7 / SNMM856-R7

Tool life = 45 min

$a_p = 6 \text{ mm} / 0.240 \text{ Inch}$

Holder: PSBNR4040S25

SMG	TP0501 f (mm/r) (in/rev)			TP2501 f (mm/r) (in/rev)			TP3501 f (mm/r) (in/rev)			TP25 f (mm/r) (in/rev)			TP40 f (mm/r) (in/rev)		
	0,6 0.020	0,9 0.035	1,2 0.047	0,6 0.020	0,9 0.035	1,2 0.047	0,6 0.020	0,9 0.035	1,2 0.047	0,6 0.020	0,9 0.035	1,2 0.047	0,6 0.020	0,9 0.035	1,2 0.047
P4	225	155	115	200	155	125	185	130	100	160	120	100	105	75	55
	850	510	375	740	510	410	690	425	330	570	395	330	395	245	180

General ISO Turning
Technical information

Steadyline®

MDT

Mini-Shaft™

Grooving

Parting-off

X4

Adapters
Clamping units

Accessories and
Spare parts

Workpiece
materials

Insert label and packaging

Inserts have to correspond to insert seat pocket on a toolholder and on the back of a insert box the insert code is written in accordance to ISO and ANSI standard. To simplify storage these codes also are added to one short side of the box.

The back also holds information of the unique batch number and product number also available as bar code see to the right.







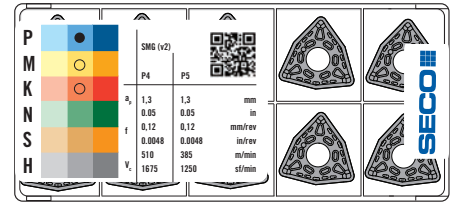
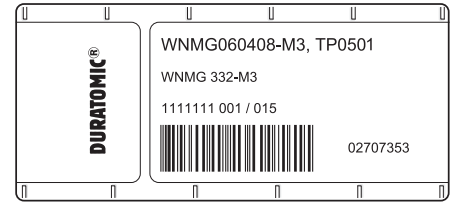





























On the front side of a general turning insert box the secolor code is present to the left (see page 32 for more clarity) and a first very general cutting data recommendation presented for two different workpiece materials categories according to the SMG classification in both metric and inch system.

Note that the QR-code in the corner provides a direct link to the present product cutting data page to allow more precise cutting data recommendations based on the specific adjustments to actual application done at www.secotools.com webpage.

If you don't have access to a computer download the Seco Assistant application, available in the Google Playstore or Apple App-store. Then you can scan the barcode or QR-code and get instant access to product-information and many more functions.



- General ISO Turning Technical information
- Steadyline®
- MDT
- Mini-Shaft™
- Grooving
- Parting-off
- X4
- Adapters Clamping units
- Accessories and Spare parts
- Workpiece materials

Chipbreaker program, positive basic shape inserts				
-AL				Chipbreaker for positive inserts. Intended for machining of aluminium alloys. The highly polished rake face and the very large rake angle ensure extremely light cutting action. Recommended machining range: $f = 0,15-0,60$ mm/rev, $a_p = 0,5-4,0$ mm. ($f = 0.006-0.024$ in/rev, $a_p = 0.020-0.160$ inch).
-FF1				Chipbreaker for positive inserts. Used to achieve a very fine finish when turning slender steel and stainless steel components. Recommended machining range: $f = 0,05-0,30$ mm/rev, $a_p = 0,2-2,0$ mm. ($f = 0.002-0.012$ in/rev, $a_p = 0.008-0.080$ inch).
-F1				Chipbreaker for positive inserts. Positive geometry with sharp cutting edge gives easy-cutting properties. Suitable for high feed rates at fine depths of cut in precision forgings and castings. Recommended machining range: $f = 0,1-0,5$ mm/rev, $a_p = 0,2-3,0$ mm. ($f = 0.004-0.020$ in/rev, $a_p = 0.008-0.120$ in). Machining in bar automatics, for instance: $f = 0,08-0,25$ mm/rev, $a_p = 1-3$ mm. ($f = 0.003-0.010$ in/rev, $a_p = 0.040-0.120$ inch).
-MF2				A versatile finishing to semi-finishing chipbreaker with light-cutting action for positive inserts. Suitable for a wide range of cuts in steel and stainless steel finishing applications including boring. Recommended machining range: $f = 0,08-0,50$ mm/rev, $a_p = 0,15-3,00$ mm. ($f = 0.003-0.020$ in/rev, $a_p = 0.006-0.120$ inch).
-M3				A reliable semi-finishing to medium roughing chipbreaker ensuring safe chip flow. Suitable for medium cuts in steel and stainless steels application including boring. Recommended machining range: $f = 0,12-0,60$ mm/rev, $a_p = 0,2-4,0$ mm. ($f = 0.005-0.024$ in/rev, $a_p = 0.008-0.160$ inch).
-M5				A highly reliable chipbreaker for positive inserts. Intended for medium-rough and rough machining of steels, stainless steels and cast iron. Combines high edge strength with comparatively low cutting forces. Safe action in interruptions and rough skin on parts also including boring. Recommended machining range: $f = 0,15-0,60$ mm/rev, $a_p = 1-5$ mm. ($f = 0.006-0.024$ in/rev, $a_p = 0.040-0.200$ inch).
-R3				Chipbreaker for large round inserts are for finishing and medium machining of difficult to machine materials from steel to superalloys also in large components such as railway wheels for enhanced difficult machine materials for enhanced chipbreaking and surface finish. Recommended machining range: $f = 0,5-1,2$ mm/rev, $a_p = 1,5-5,0$ mm. ($f = 0.020-0.047$ in/rev, $a_p = 0.060-0.200$ inch).
-RR93				Chipbreaker for large round inserts are for medium machining and roughing of railway wheels, large components. Recommended machining range: $f = 0,6-1,5$ mm/rev, $a_p = 3,0-10,0$ mm ($f = 0.024-0.060$ in/rev, $a_p = 0.120-0.400$ inch).
-RR94				Chipbreaker for large inserts intended for roughing of railway wheels. Recommended machining range: $f = 0,6-1,5$ mm/rev, $a_p = 3,0-10,0$ mm. ($f = 0.024-0.060$ in/rev, $a_p = 0.120-0.400$ inch).
-RR96				Chipbreaker for large inserts intended for machining of steel with high depth of cut and large feed rates. Recommended machining range: $f = 0,6-2,2$ mm/rev, $a_p = 3,0-24,0$ mm. ($f = 0.024-0.085$ in/rev, $a_p = 0.120-0.945$ inch).
-RR97				Chipbreaker for large inserts intended for machining of steel with high depth of cut and large feed rates. The -RR97 geometry is stronger than the -RR96. Recommended machining range: $f = 0,8-2,2$ mm/rev, $a_p = 3,0-24,0$ mm. ($f = 0.032-0.085$ in/rev, $a_p = 0.120-0.945$ inch).
-UX				Chipbreaker for positive inserts. Smooth and easy chip flow on finishing and medium roughing in steel and stainless steel. Well suited for slim components. Recommended machining range: $f = 0,05-0,40$ mm/rev, $a_p = 0,5-4,0$ mm. ($f = 0.002-0.016$ in/rev, $a_p = 0.020-0.160$ inch).

General ISO Turning
Technical information

Steadyline®

MDT

Mini-Shaft™

Grooving

Parting-off

X4

Adapters
Clamping units

Accessories and
Spare parts

Workpiece
materials

General ISO Turning
Technical information

Steadyline®

MDT

Mini-Shaft™

Grooving

Parting-off





































X4

Adapters
Clamping units

Accessories and
Spare parts

Workpiece
materials

Chipbreaker program, negative basic shape inserts			
-FF1			Chipbreaker for negative inserts. Used to achieve a very fine finish when turning slender steel and stainless steel components. Recommended machining range: $f = 0,08-0,30$ mm/rev, $a_p = 0,2-3,0$ mm. ($f = 0.003-0.012$ in/rev, $a_p = 0.008-0.120$ inch)
-FF2			Chipbreaker for negative inserts. Intended for fine-finishing and semi-finishing of steels and stainless steels. The positive, tight chip groove offers light cutting action combined with superior chip forming. Recommended machining range: $f = 0,08-0,30$ mm/rev, $a_p = 0,2-1,5$ mm. ($f = 0.003-0.012$ in/rev, $a_p = 0.008-0.060$ inch).
-MF1			Chipbreaker intended for machining stainless steel, superalloys and titanium alloys. Type ..GG insert has a sharp, precision ground edge. Type ..MG insert has a lightly honed cutting edge for increased strength. MF1 is intended for use in semi-finishing and finishing applications. Recommended machining range: $f = 0,08-0,30$ mm/rev, $a_p = 0,2-3,5$ mm. ($f = 0.003-0.012$ inch/rev, $a_p = 0.008-0.140$ inch).
-MF2			First choice for finishing with negative inserts. Suitable for chip control at depths of cut down to 0,25 mm, provided that the feed rate is in excess of 0,25 mm/rev. Good capacity for medium rough machining. Recommended machining range: $f = 0,10-0,40$ mm/rev, $a_p = 0,2-3,0$ mm. ($f = 0.004-0.016$ in/rev, $a_p = 0.008-0.120$ inch).
-MF3			Chipbreaker with positive cutting rake angle intended for moderately difficult stainless steel. The MF3 is also intended for light roughing in relatively soft, "tacky" steel and difficult to machine stainless steel if the depth of cut is limited. MF3 can also be used for finishing of cast iron. Recommended machining range: $f = 0,2-0,4$ mm/rev, $a_p = 1-4$ mm. ($0.008-0.016$ in/rev, $a_p = 0.040-0.160$ inch).
-MF4			Chipbreaker intended for medium/finishing of stainless steel, very open and highly positive geometry. Recommended machining range: $f = 0,15-0,50$ mm/rev, $a_p = 0,5-4,0$ mm. ($f = 0.006-0.020$ in/rev, $a_p = 0.020-0.160$ inch).
-MF5			Chipbreaker intended for medium finishing of steel and stainless steel at high feeds. Very easy cutting and open geometry. Recommended machining range: $f = 0,2-0,8$ mm/rev, $a_p = 0,2-2,7$ mm. ($f = 0.008-0.032$ in/rev, $a_p = 0.008-0.100$ inch).
-M1			Chipbreaker intended for superalloys and titanium alloys. It has a positive cutting rake angle which is slightly honed to increase the edge strength. Also available with a perfectly sharp edge (type ..GG insert). The M1 is intended for light roughing and for semi-finishing. Recommended machining range: $f = 0,2-0,4$ mm/rev, $a_p = 1,5-5,0$ mm. ($f = 0.008-0.016$ in/rev, $a_p = 0.60-0.200$ inch).
-M3			First choice for medium-rough machining and also the most versatile Seco chipbreaker. In most cases, it is the only chipbreaker needed. Offers the best useful life and best chipbreaking in a wide range of cutting data and workpiece materials. Suitable for precision forged and cast workpieces (NNS or Near Net Shape workpieces) as regards both chip control and edge strength. Recommended machining range: $f = 0,15-0,50$ mm/rev, $a_p = 0,5-5,0$ mm. ($f = 0.006-0.020$ in/rev, $a_p = 0.020-0.200$ inch).
-M4			Chipbreaker intended for cast iron. Positive rake angle with a narrow T-land gives low cutting forces. First choice for cast iron machining at high speeds. Recommended machining range: $f = 0,1-0,7$ mm/rev, $a_p = 0,2-5,0$ mm. ($f = 0.004-0.028$ in/rev, $a_p = 0.008-0.200$ inch).
-M5			The choice for roughing by means of double-sided inserts. Intended for demanding operations at high feed rates in steel, stainless steel and cast iron. Combines high edge strength with comparatively low cutting forces. Recommended machining range: $f = 0,3-0,7$ mm/rev, $a_p = 1,5-7,0$ mm. ($f = 0.012-0.028$ in/rev, $a_p = 0.060-0.280$ inch).
-M6			Strong double-sided chipbreaker, intended for semi-roughing and roughing of steel. A well-balanced design combining excellent chip control and relatively low cutting forces which provides reliable cutting action in both continuous as well as interrupted cuts. Well suited also for machining of ferritic and martensitic stainless steels. Recommended machining range: $f = 0,2-0,8$ mm/rev, $a_p = 1,0-7,0$ mm. ($f = 0.008-0.031$ in/rev, $a_p = 0.040-0.275$ inch).

Chipbreaker program, negative basic shape inserts			
-MR3		 	Chipbreaker with a positive cutting rake angle that reduces cutting forces and gives a very high edge strength. Intended for medium-rough and rough machining of superalloys, titanium alloys and stainless and hardened steel. Recommended machining range: $f = 0,2-0,6$ mm/rev, $a_p = 1,5-7,0$ mm. ($f = 0.008-0.024$ in/rev, $a_p = 0.060-0.280$ inch).
-MR4		 	The MR4 has a negative T-land, which gives extremely high edge strength. The chipbreaker is intended for more difficult machining applications on superalloys and titanium alloys, such as intermittent cuts and the machining of parts with raw surface. Recommended machining range: $f = 0,15-0,50$ mm/rev, $a_p = 1,5-7,0$ mm. ($f = 0.006-0.020$ in/rev, $a_p = 0.060-0.280$ inch).
-MR6		 	Chipbreaker for medium and medium roughing of steel. Very easy cutting and open geometry. Double and single-sided. Recommended machining range: $f = 0,25-0,80$ mm/rev, $a_p = 0,9-5,0$ mm. ($f = 0.010-0.032$ in/rev, $a_p = 0.035-0.200$ inch).
-MR7		 	The strongest chipbreaker for double-sided inserts. The MR7 is suitable for high feed rates and depths of cut that normally require a single-sided insert. The chipbreaker has a wide negative T land, which gives high edge strength. Recommended machining range: $f = 0,35-0,90$ mm/rev, $a_p = 1,5-7,0$ mm. ($f = 0.014-0.035$ in/rev, $a_p = 0.060-0.280$ inch).
-MR9		 	The strongest chipbreaker intended for cast iron. The negative chamfers makes it very suitable for high feeds in interrupted cuts and still with very reliable action in cast irons. Recommended machining range: $f = 0,2-1,0$ mm/rev, $a_p = 1,0-12$ mm. ($f = 0.008-0.040$ in/rev, $a_p = 0.040-0.470$ inch).
-R4		 	Chipbreaker for single-sided inserts. It has a positive cutting edge which gives low cutting forces. Recommended machining range: $f = 0,2-0,6$ mm/rev, $a_p = 2-10$ mm. ($f = 0.008-0.024$ in/rev, $a_p = 0.080-0.400$ inch).
-R5		 	Chipbreaker for single-sided inserts. Recommended for medium-roughing of steel. Recommended machining range: $f = 0,3-1,0$ mm/rev, $a_p = 2-12$ mm. ($f = 0.012-0.040$ in/rev, $a_p = 0.080-0.475$ inch).
-56 -R56		 	Chipbreaker with easy-cutting geometry for single-sided inserts. Intended for stainless steel machining applications. Recommended machining range: $f = 0,4-0,8$ mm/rev, $a_p = 2-12$ mm. ($f = 0.016-0.032$ in/rev, $a_p = 0.080-0.470$ inch).
-57 -R57		 	Chipbreaker for single-sided roughing inserts. Recommended for roughing operations on steel at high feed rates and high depth of cut. Recommended machining range: $f = 0,45-1,10$ mm/rev, $a_p = 2-12$ mm. ($f = 0.018-0.042$ in/rev, $a_p = 0.080-0.470$ inch).
-R6		 	Chipbreaker for single-sided inserts. Recommended for medium-roughing of stainless steel. Recommended machining range: $f = 0,25-0,70$ mm/rev, $a_p = 2-10$ mm. ($f = 0.010-0.028$ in/rev, $a_p = 0.080-0.400$ inch).
-R68		 	Chipbreaker for single sided insert. Recommended for heavy-roughing of steel. Recommended machining range: $f = 0,4-1,4$ mm/rev, $a_p = 4-14$ mm. ($f = 0.016-0.055$ in/rev, $a_p = 0.160-0.550$ inch).
-R7		 	A strong but easy-cutting chipbreaker for single sided inserts. The R7 is well suited for intermittent machining of both stainless and ordinary carbon steel. Recommended machining range: $f = 0,4-1,6$ mm/rev, $a_p = 3-18$ mm. ($f = 0.016-0.063$ in/rev, $a_p = 0.120-0.700$ inch).

General ISO Turning
Technical information

Steadyline®

MDT

Mini-Shaft™

Grooving

Parting-off

X4

Adapters
Clamping units

Accessories and
Spare parts

Workpiece
materials

Chipbreaker program, negative basic shape inserts			
-R8		 	A very strong chipbreaker for single-sided inserts. The R8 is intended for high feed rates when machining castings and forgings of austenitic stainless steel. Recommended machining range: $f = 0,35-0,80$ mm/rev, $a_p = 2-12$ mm. ($f = 0.014-0.032$ in/rev, $a_p = 0.080-0.470$ inch).
-RR6		 	A very easy-cutting chipbreaker for single-sided inserts. Recommended for roughing of stainless steel and steel. Recommended machining range: $f = 0,3-1,0$ mm/rev, $a_p = 2-12$ mm. ($f = 0.012-0.040$ in/rev, $a_p = 0.080-0.470$ inch).
-RR9		 	Extremely strong chipbreaker for single-sided negative inserts, for use at high feed rates. Suitable for difficult castings and forgings and for austenitic stainless steel. Recommended machining range: $f = 0,5-1,2$ mm/rev, $a_p = 2,5-15,0$ mm. ($f = 0.020-0.047$ in/rev, $a_p = 0.100-0.590$ inch).
-RR96		 	Heavy roughing chipbreaker for negative single-sided inserts for high parameters and chip control for all materials. Recommended machining range for LNMX50: $f = 1,5-2,6$ mm/rev, $a_p = 12-36$ mm. ($f = 0.060-0.100$ in/rev, $a_p = 0.470-1.415$ inch).
-UX		 	Chipbreaker for negative inserts. Positive cutting rake with sharp edge. Low cutting force. Suitable for slim components. Recommended machining range: $f = 0,2-0,4$ mm/rev, $a_p = 1,0-6,0$ mm. ($f = 0.008-0.016$ in/rev, $a_p = 0.040-0.240$ inch).

Chipbreakers

General ISO Turning
Technical information

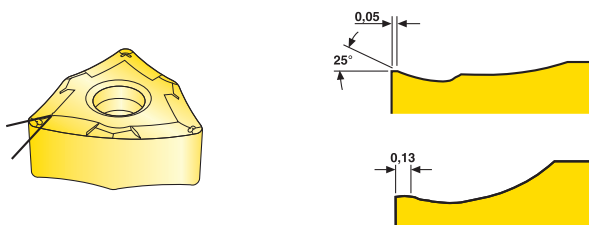
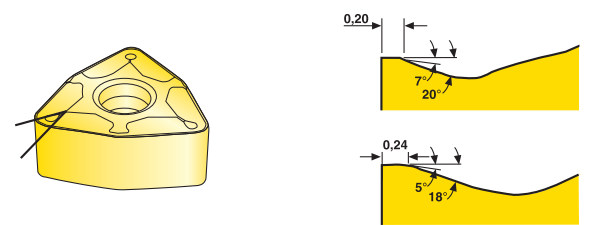
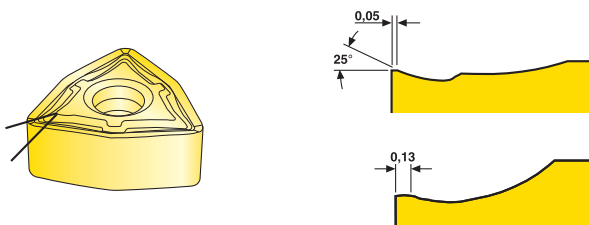
<p>-MF2 – For finishing</p> 	<p>-M3 – For general machining</p> 
<p>-M5 – For roughing</p> 	<p>The design of a chipbreaker is made to give both good chipcontrol and additional functional benefits appropriate for the intended materials, applications and components.</p> <p>Consequently a number of features on a specific insert differ to adapt to those needs as indicated in the drawings.</p>

Steadyline®

MDT

Mini-Shaft™

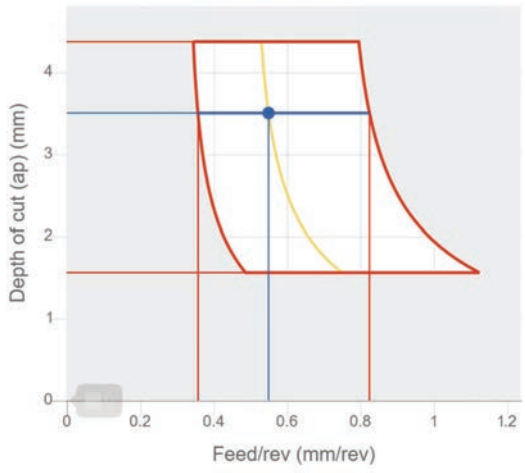
<p>-MF2, -M3, -M5</p> <p>Working range ap(f)</p> 	<p>For a certain insert and chipbreaker combination there is a recommended working range and depend on several aspects in insert design and of machining conditions such as component and path.</p> <p>When logged in on www.secotools.com or Mypages specific cutting data graphs for general turning insert are available if Advanced Cutting Data section are expanded.</p>
---	---

Grooving

Parting-off

X4

Adapters
Clamping units

Accessories and
Spare parts

Workpiece
materials

High Feed Wiper inserts

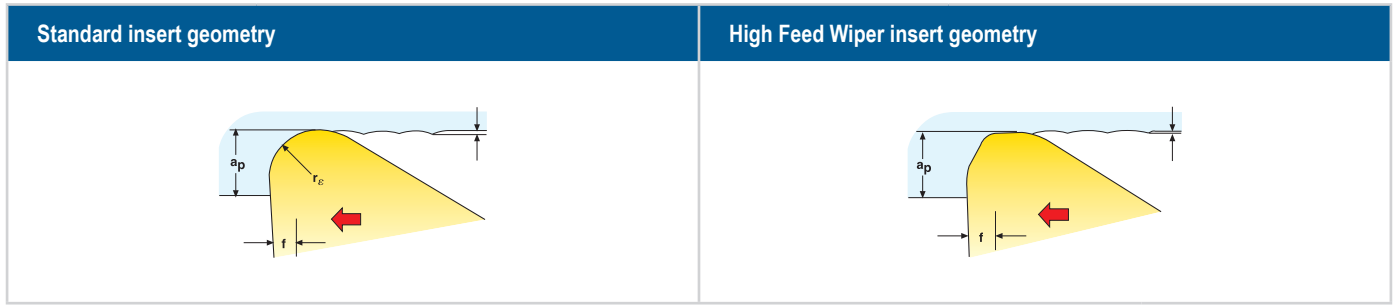

Often comes the question how a High Feed Wiper can generate that significantly better surface finish at the same feed rate compared to standard insert.

When looking closer to the design of an insert edge regardless if either e.g. coated carbide or PCBN insert there are similarities.

Below diagrams show the Ra-value as a function of feed rate when using standard nose radius inserts and High Feed Wiper inserts.

Regardless of chipbreaker design and workpiece material there are solutions available corresponding to the need.

M3 = Standard -M3, W-M3 = Wiper -M3

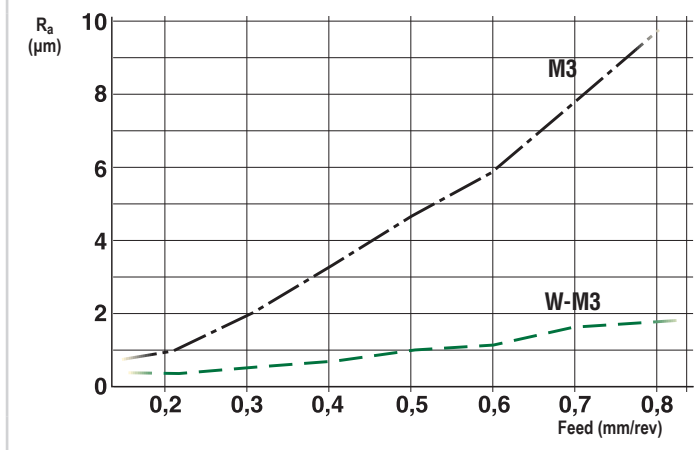

The diagram shows the superior surface finish in steel achieved with a Seco High Feed W-M3 wiper insert compared to a conventional insert.

CNMG120408W-M3 TP2501, $a_p = 1$ mm, cutting speed adjusted for feed, workpiece material: (steel) SMG P4.

Note that opportunities to do the same surface finish comparison for each specific product and application when logged in on www.secotools.com under the Advanced Cutting Data section.



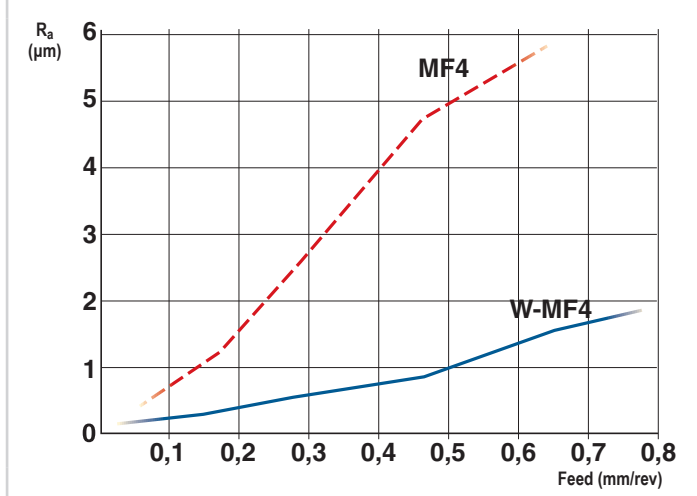























MF4 = Standard -MF4, W-MF4 = Wiper -MF4



When applying a Seco High Feed W-MF4 wiper insert in stainless steel the diagram shows the superior surface finish achieved compared to a conventional insert in stainless steel.

CNMG120408W-MF4 TM4000, $a_p = 1$ mm, cutting speed tool life adjusted for feed in SMG M2 (stainless steel).

General ISO Turning Technical information
Steadyline®
MDT
Mini-Shaft™
Grooving
Parting-off
X4
Adapters Clamping units
Accessories and Spare parts
Workpiece materials

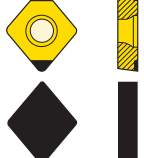
Chipbreaker program, High Feed Wiper inserts			
W-F1		 	A versatile chipbreaker for positive inserts. For finishing machining of steel, stainless steel and cast iron giving good surface finish. Suitable for high feed rates at small depths of cut. Recommended machining range: $f = 0,05-0,50$ mm/rev, $a_p = 0,25-3,00$ mm. ($f = 0.002-0.020$ in/rev, $a_p = 0.010-0.120$ inch).
W-FF2		 	Chipbreaker for high feed finishing of steel and stainless steel. Wide chip control range in finishing and generates a superior surface quality. Recommended machining range: $f = 0,1-0,5$ mm/rev, $a_p = 0,2-1,5$ mm. ($f = 0.004-0.020$ in/rev, $a_p = 0.008-0.060$ inch).
W-MF2		 	First choice for finishing with both positive and negative inserts. Chipbreaker suitable for finishing machining of steel, stainless steel and cast iron at high feed rates giving good surface finish. Recommended machining range: $f = 0,05-0,60$ mm/rev, $a_p = 0,5-4,0$ mm. ($f = 0.002-0.024$ in/rev, $a_p = 0.020-0.160$ inch).
W-MF4		 	Easy cutting action chipbreaker for high feed machining of stainless steel. Provides good surface finish in finishing operations and High Feed Wiper productivity in medium-roughing machining. Recommended machining range: $f = 0,05-0,90$ mm/rev, $a_p = 0,2 - 6,0$ mm. ($f = 0.002-0.035$ in/rev, $a_p = 0.008 - 0.240$ inch).
W-MF5		 	Chipbreaker intended for medium finishing of steel at high feed. The geometry is very open and highly positive and equipped with wiper radius. Recommended machining range: $f = 0,2-0,8$ mm/rev, $a_p = 0,2-2,7$ mm. ($f = 0.008-0.032$ in/rev, $a_p = 0.008-0.105$ inch).
W-M3		 	Versatile chipbreaker in both positive and negative inserts for high feed finishing and medium-roughing machining of steel, stainless steel and cast iron. Operates in a wide application area. Gives a good surface finish even at high feeds. Recommended machining range: $f = 0,2-0,9$ mm/rev, $a_p = 0,5-6,0$ mm. ($f = 0.008-0.035$ in/rev, $a_p = 0.020-0.240$ inch).
W-M6		 	Strong double-sided chipbreaker, intended for high-feed semi-roughing and roughing of steel. A well-balanced design combining excellent chip control and relatively low cutting forces which provides reliable cutting action in both continuous as well as interrupted cuts. Recommended machining range: $f = 0,3-1,0$ mm/rev, $a_p = 1,0-7,0$ mm. ($f = 0.012-0.040$ in/rev, $a_p = 0.040-0.275$ inch).
W-R4		 	Chipbreaker for single sided inserts intended for high feed medium-roughing and rough machining of steel, stainless steel and cast iron. Gives a good surface finish even at high feeds. Low cutting forces. Recommended machining range: $f = 0,3-1,0$ mm/rev, $a_p = 2,0-7,5$ mm. ($f = 0.012-0.040$ inch/rev, $a_p = 0.080-0.295$ inch).
W-R7		 	A strong easy cutting chipbreaker for single sided inserts. Intended for the highest feeds when medium-roughing and roughing machining of steel, stainless steel and cast iron. Gives a good surface finish even at the higher feeds. Recommended machining range: $f = 0,4-1,2$ mm/rev, $a_p = 2,0-9,5$ mm. ($f = 0.016-0.048$ in/rev, $a_p = 0.080-0.375$ inch).
-WZ -WZN -WZP -WS -WL			Wiper geometries on PCBN inserts. Available in various insert styles in solid or brazed format. Developed for machining pearlitic grey cast iron and hardened steel. Gives a high quality surface finish at high feeds.

General ISO Turning
Technical information

Steadyline®

MDT

Mini-Shaft™

Grooving

Parting-off

X4

Adapters
Clamping units

Accessories and
Spare parts

Workpiece
materials

Operation guidelines

C- and W-basic shape High Feed Wiper inserts

- The favourable surface finish results are lost, if the cutting edge angle diverges from 95°.
- Max diversion allowed: $\pm 2^\circ$.
- Back-turning is NOT recommended.

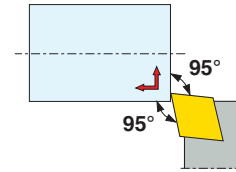

On C-style High Feed inserts, except for PCBN inserts, the wiper geometry is also located on the 100° corner.
When using W-R4 or W-R7 chipbreaker use a toolholder with P- or M-type clamping.

D- and T-basic shape High Feed Wiper inserts

- The favourable surface finish results are lost, if the cutting edge angle diverges from 93°.
- Max diversion allowed: $\pm 2^\circ$.
- Back-turning is NOT recommended.

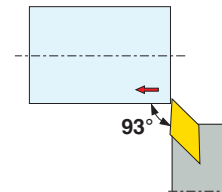

S-basic shape High Feed Wiper inserts

- S-style High Feed insert to be used in a toolholder with 75° setting angle. The favourable surface finish results are lost, if the cutting edge angle diverges from 75°. Max diversion allowed: $\pm 2^\circ$.

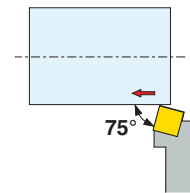

Copying with D- and T-style Wiper inserts

Since D- and T-style High Feed inserts not are designed within ISO-tolerances, an adjustment in the tool offset must be made.
A deviation from the nominal nose radius shape, will always occur (D1, D2) when going towards a corner.

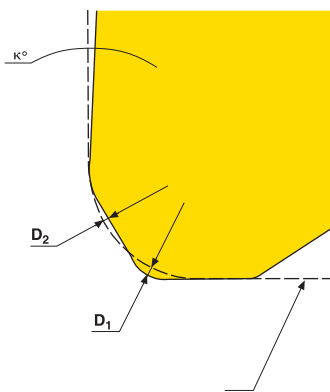



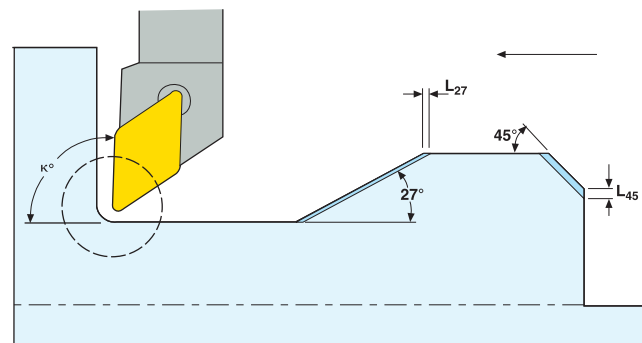







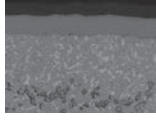





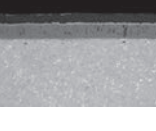

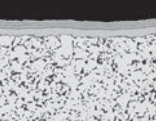

ISO-profile (Nominal nose radius)

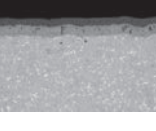

The High Feed geometry on a D-and T-style insert does not provide an exact corner radius.

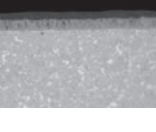
When copying with a D- or T-style High Feed insert, an adjustment must be made for dimensional deviations.

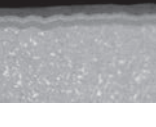
CVD Coated Grades			
TP0501			Duratomic® grade. A grade with an extremely high degree of heat and wear resistance for many steel applications such as in alloy steels and especially capable under dry conditions. Also applicable for demanding applications in cast irons. Ti(C,N) + Al ₂ O ₃ + Used Edge Detection (Chrome)
TP1501			Duratomic® grade. Highly heat and wear resistant grade extremely well suited for productive general turning of steels and a useful backup in other material groups. Ti(C,N) + Al ₂ O ₃ + Used Edge Detection (Chrome)
TP2501			Duratomic® grade. Designed with high wear resistance and edge strength applicable in a wide range of turning applications in steels as well as many stainless steels and cast irons. Ti(C,N) + Al ₂ O ₃ + Used Edge Detection (Chrome)
TP3501			Duratomic® grade. Enhanced edge toughness still with the characteristic high wear resistance intended for versatile performance in turning applications in steels as well as stainless steels especially including interrupted cuts. Ti(C,N) + Al ₂ O ₃ + Used Edge Detection (Chrome)
TP25			Universal grade for high versatile performance over a wide range of applications in steels, stainless steels and cast irons. Trustworthy alternative at limited cutting speeds or high surface finish requirements. Ti(C,N) + Al ₂ O ₃ + Used Edge Detection (Chrome)
TP200			Universal grade for high versatile performance over a wide range of application in steels, stainless steels and cast irons. Ti(C,N) + Al ₂ O ₃ + TiN
TP40			Universal grade for a extremely secure performance in the most demanding application from steels, stainless steels to superalloys especially in castings and forgings. TiC/Ti(C,N) + TiN
TH1500			Duratomic® grade. An extremely hard super micrograin grade intended for machining of partly hardened steels and provides an alternative for cast iron finishing. Ti(C,N) + Al ₂ O ₃
TM1501			Duratomic® grade. Highly resistant and optimized grade for many continuous cut in stainless steel turning applications. Complements in mixes of steel and stainless steel turning. Ti(C,N) + Al ₂ O ₃ + Used Edge Detection (Chrome)
TM2501			Duratomic® grade. A highly capable grade for austenitic stainless steel turning with combinations of high resistance and superior edge toughness. First choice in austenitic stainless steel turning. Complements in steel turning with heavy intermittent cuts. Ti(C,N) + Al ₂ O ₃ + Used Edge Detection (Chrome)
TM3501			Duratomic® grade. First choice in duplex and more difficult-to-cut stainless steels and highly resistant to notch wear and chipping. Superior in finishing and in intermittent cuts in all stainless steel alloys. Versatile grade, covering a variety of stainless steel alloys and operations. Ti(C,N) + Al ₂ O ₃ + Used Edge Detection (Chrome)

General ISO Turning
Technical information

Steadyline®

MDT

Mini-Shaft™

Grooving

Parting-off

X4

Adapters
Clamping units

Accessories and
Spare parts

Workpiece
materials

General ISO Turning
Technical information

Steadyline®

MDT

Mini-Shaft™

Grooving

Parting-off









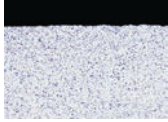

X4

Adapters
Clamping units

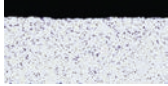
Accessories and
Spare parts

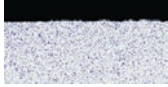
Workpiece
materials

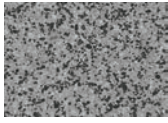
CVD Coated Grades			
TK0501			Duratomic® grade. A extremely wear resistant optimized grade choice for machining of grey cast iron and many ductile cast irons. Ti(C,N) + Al ₂ O ₃ + Used Edge Detection (Chrome)
TK1501			Duratomic® grade. A highly wear resistant grade for cast irons in general as well as in steels. The grade is particularly capable in machining of ductile (nodular) cast irons also in more demanding setups and interrupted cuts. Ti(C,N) + Al ₂ O ₃ + Used Edge Detection (Chrome)
PVD Coated Grades			
TH1000			Very hard supermicrograin grade intended for partly hardened steel components as well as general "hard-to-cut" workpiece materials such as superalloys and due to remarkable edge toughness it also provides high performance in interrupted cuts and hard-surface removal. Ti-Al-Si-N nanolaminate coating
TS2000			Hard micrograin wear resistant grade intended for finishing in superalloys and titanium as well as in many stainless steels. (Ti,Al)N + TiN
TS2050			Hard and wear resistant micrograin grade intended for finishing and semi-finishing of superalloys. Ti-Al-Si-N nanolaminate coating
TS2500			Relatively hard micrograin grade for machining of superalloys and titanium in roughing applications and due to its design also applicable in a wide range of materials such as stainless steels. (Ti,Al)N + TiN
CP200			Hard micrograin grade principally intended for finishing in superalloys and titanium. Also works well in stainless steels. (Ti, Al) N + TiN
CP500			Tough micrograin grade intended for finishing to medium-roughing of stainless steels but with wide applicability for example in steels and aluminium alloys. Especially suitable in intermittent cuts. (Ti,Al)N + TiN
CP600			Very tough micrograin grade intended for stainless steels and steels applicable but generally applicable when ever high edge toughness required e.g. more difficult interrupted cuts. (Ti,Al)N + TiN

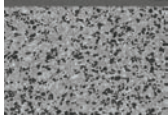
Uncoated Grades			
HX			Universal uncoated grade intended for machining of cast iron and hardened steels useful also in non-ferrous materials.
KX			Optimized micrograin grade intended for the machining of aluminium and other non-ferrous materials.
883			Relatively hard and still tough uncoated micrograin grade for machining of titanium in roughing applications and also suitable for superalloys.
890			High hardness uncoated micrograin grade maintaining good toughness intended for superalloys and titanium can also be applied in other materials.
Cermets			
TP1020			High wear resistance cermet grade for highest surface finish with predictability, first of all, in steels and stainless steels.
TP1030			Coated highly wear resistant cermet grade for high surface finish and productivity requirements mainly used in steels and stainless steels. Ti-Al-Si-N nanolaminate coating.

General ISO Turning
Technical information

Steadyline®

MDT

Mini-Shaft™

Grooving

Parting-off

X4

Adapters
Clamping units

Accessories and
Spare parts

Workpiece
materials

Cartridges – Mounting information

Angular Mount Cartridges

- Conform to ISO-ANSI standards
- Accommodate positive and negative rakes
- Use standard, interchangeable Seco seats and chipbreakers
- Fit any cat-head, boring bar or tool block
- now using ISO-ANSI cartridges
- Allow axial and radial adjustment
- Instant metric/inch conversion with simple substitution of components

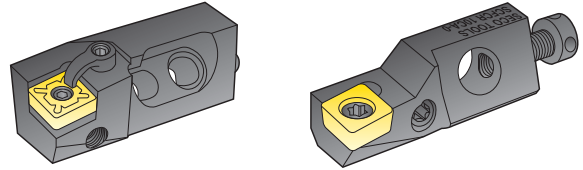

90° Mount Cartridges

- Provide close-tolerance machining with radial and axial adjustments of M and PC types

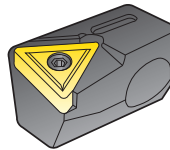

Mounting Information: ISO-ANSI, Angular Mount Cartridges

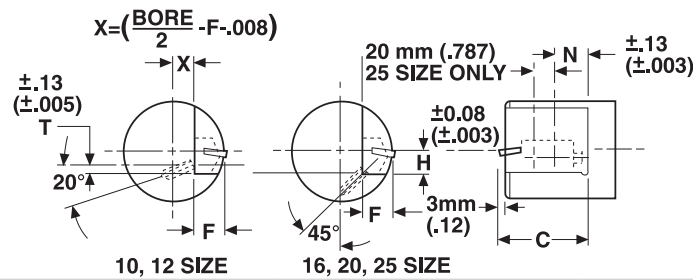

Cartridge size		C mm/inch	F mm/inch	H mm/inch	T mm/inch	N mm/inch	Hold Down Screw	
Metric Std.	Inch Std.						Metric Std.	Inch Std.
10	39	50 / 1.968	14 / .551	10 / .394	5 / .196	20 / .787	M6 (Low Hd.)	1/4 (Low Hd.)
12	47	55 / 2.165	20 / .787	12 / .472	6 / .236	20 / .787	M6	1/4
16	63	63 / 2.480	24 / .945	16 / .630	-	25 / .984	M8	5/16
20	79	70 / 2.756	25 / .984	20 / .787	-	30 / 1.181	M8	5/16
25	98	100 / 3.937	32 / 1.260	25 / .984	-	30 / 1.181	M10 (2)	3/8 (2)

Cartridge Reference Guide

Cartridges are stocked with metric parts as standard.
Components with inch drives are available as optional spare parts.
See substitution charts below.







Lock Pins		Clamp Screws		Rad. Adj. Screws	
Metric (standard)	Inch (optional)	Metric (standard)	Inch (optional)	Metric (standard)	Inch (optional)
NLM-23	NLC-23	XNSM-0515	XNSC-0515	SASM-0406	SASC-0406
NLM-33	NLC-33	XNSM-0620	XNSC-0620	SASM-0412	SASC-0412
NLM-34L	NLC-34L	XNSM-0825	XNSC-0825	SASM-0516	SASC-0516
NLM-43	NLC-43			SASM-0620	SASC-0620
NLM-46S	NLC-46S			SASM-0820	SASC-0820
NLM-54	NLC-54				
NLM-58	NLC-58				
NLM-68	NLC-68				

Railway wheels – Introduction

Turning – New railway wheels

The product range consists of:

- Inserts for finish machining RCMT-R3 and RCMX-R3 geometries
- Inserts for rough machining RR93, H-RR93 & RR94 geometries
- Inserts for heavy roughing at high feed rate RR97 geometry
- Solid PRDCN toolholders up to 50x50 shank
- Seco-Capto™ custom made toolholders

R3	RR94, RR93
<p>Strong geometries for finishing and semi finishing at high feed rates</p> <div style="display: flex; justify-content: space-around;">   </div> <p style="text-align: center;"> RCMX-R3 RCMT-R3 </p> <p>Feed recommendation: 0,5-1,2 mm/rev / 0.002-0.047 in/rev D.O.C. recommendation: $a_p < 5 \text{ mm}$ / 0.197 inch</p>	<p>Strong geometries for medium machining and roughing at high feed rates</p> <div style="display: flex; justify-content: space-around;">    </div> <p style="text-align: center;"> RCMX-RR94 RCMX-RR93 RCMX-H-RR93 </p> <p>Feed recommendation: 0,6-1,4 mm/rev / 0.024-0.055 in/rev D.O.C. recommendation: $a_p < 12 \text{ mm}$ / 0.472 inch</p>
RCMX-RR97	SNMM-R7
<p>Strong geometries for machining at high feed rates.</p> <div style="text-align: center;">  </div> <p>Feed recommendation: 0,6-1,5 mm/rev / 0.024-0.059 in/rev D.O.C. recommendation: $a_p < 15 \text{ mm}$ / 0.591 inch</p>	<p>For roughing operations at high feed rates and large depth of cut.</p> <div style="text-align: center;">  </div> <p>Feed recommendation: 0,6-1,2 mm/rev / 0.024-0.047 in/rev D.O.C. recommendation: $a_p < 15 \text{ mm}$ / 0.591 inch</p>

R3, RR93 geometries with the chipbreaker grooves and bumps improves the chipbreaking.

Seco dedicated Duratomic® grades improves the performance.

Railway wheel re-turning

The product range consists of:

- Inserts for finish machining MF and R2 geometries
- Inserts for medium rough machining RR94 geometry
- Inserts for rough machining MR and RR97 geometries
- Edge strength order R2-MF-RR94-MR-RR97
- Cassettes for railway wheel re-turning RWRT

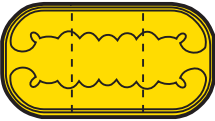
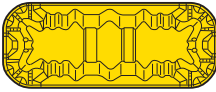
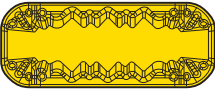
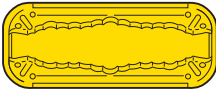
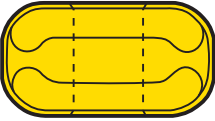
<p>LNMX-MF</p> <p>For re-machining at small depth of cut. (Normally used when machining with an under floor lathe.)</p>  <p>Feed recommendation: 0,4-1,0 mm/rev / 0.016-0.039 in/rev D.O.C. recommendation: $a_p < 10$ mm / 0.394 inch</p>	<p>LNMX19-R2</p> <p>R2 – for less worn out, soft wheels for best chip control.</p>  <p>Feed recommendation: 0,40-1,10 mm/rev / 0.016-0.043 in/rev D.O.C. recommendation: $a_p = 2-5$ mm / 0.079-0.197 inch</p>
<p>LNMX-RR94</p> <p>RR94 – for the moderately damaged wheels.</p>  <p>D.O.C. and feed recommendation: LNMX19, $a_p = 2-5$ mm / 0.079-0.197 inch; $f = 0,45-1,40$ mm/rev / 0.018-0.055 in/rev LNMX30, $a_p = 2-10$ mm / 0.079-0.394 inch; $f = 0,55-1,80$ mm/rev / 0.022-0.071 in/rev</p>	<p>LNMX-RR97</p> <p>RR97 – for the highly damaged wheels at high parameters.</p>  <p>D.O.C. and feed recommendation: LNMX30, $a_p = 2-12$ mm / 0.079-0.472 inch; $f = 0,75-1,80$ mm/rev / 0.030-0.071 in/rev</p>
<p>LNMX-MR</p> <p>Basic choice for re-machining.</p>  <p>Feed recommendation: 0,6-2,0 mm/rev / 0.024-0.079 in/rev D.O.C. recommendation: $a_p < 15$ mm / 0.591 inch</p>	

General ISO Turning
Technical information

Steadyline®

MDT

Mini-Shaft™

Grooving

Parting-off

X4

Adapters
Clamping units

Accessories and
Spare parts

Workpiece
materials

Cassettes for railway wheel re-turning RWRT

Standard products

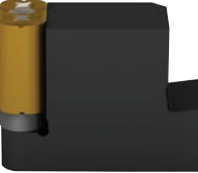
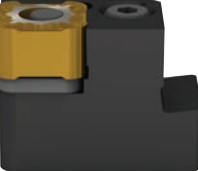
CT-PLANR/L (R/L175.32)	CT-PLFNR/L (R/L177.32-3219-19)
<p>Pin clamped cassettes for LNMX19 and LNMX30</p>  <p>Right-hand version shown</p>	<p>Pin clamped cassettes for LNMX19 and LNMX30</p>  <p>Right-hand version shown</p>
CT-PSANR/L	<p>The cassettes are equipped with carbide shims for insert support and cassette protection. The toolholders for these cassettes are machine specific. The combination cassettes are also machine specific. Some of them are offered as specials.</p>
<p>Lever clamped cassettes for SNMX1911</p>  <p>Right-hand version shown</p>	

General ISO Turning
Technical information

Steadyline®

MDT

Mini-Shaft™

Grooving

Parting-off

X4

Adapters
Clamping units

Accessories and
Spare parts

Workpiece
materials

Selection of insert format – PCBN

Insert grades – PCBN

Uncoated:

CBN010
CBN150
CBN170
CBN200
CBN300
CBN500
CBN600

PVD coated grades:

CBN060K
CBN170C
CBN300P
CK2065
CBN400C
CH0550
CH2540
CH3515

Solid insert

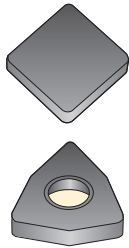

According to the geometry, two sides can be used.

Grades:

CH0550, CBN060K, CH2540, CBN300P, CK2065, CBN400C, CBN010, CBN150, CBN170, CBN200, CBN300, CBN500, CBN600

Toolholder styles:

D, P, C and M

CBN060K and CBN300 are also, in some geometries, available with hole.

Sintered layer insert -LF

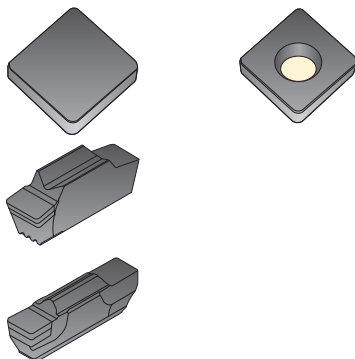

CBN layer sintered on to carbide. One side is usable.

Grades:

CBN060K, CH3515, CBN010, CBN150, CBN200

Toolholder styles:

S, C and M

MDT

Grades:

CBN010, CBN170, CBN200

Brazed tip insert -L1 (single and double sided) and -L2

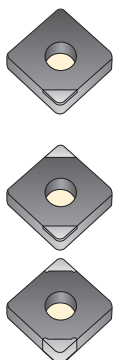

CBN brazed onto standard carbide inserts.

Grades:

CH0550, CBN060K, CH2540, CH3515, CBN010, CBN150, CBN170, CBN200

Toolholder styles:

D, P, S and M

General ISO Turning
Technical information

Steadyline®

MDT

Mini-Shaft™

Grooving





Parting-off

X4

Adapters
Clamping units

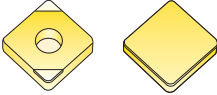
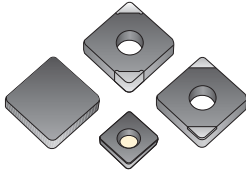
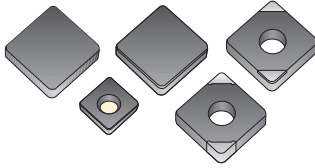
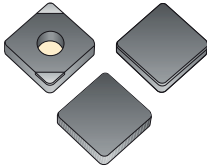
Accessories and
Spare parts

Workpiece
materials

PCBN grades, coated		
CH0550		<p>Format: Solid & brazed tips (single & double sided).</p> <p>Composition: 40% cBN bi-modal grain size distribution with average grain size of 3 μm and a TiCN ceramic binder.</p> <p>Coating: (Ti, Al, Cr)N coating.</p>
CBN060K		<p>Format: Solid, full-face layer and brazed tips (single and double sided).</p> <p>Composition: 60% cBN content grade with an average grain size of 1-2 μm and a TiCN ceramic binder.</p> <p>Coating: (Ti, Al, Si)N coating.</p>
CH2540		<p>Format: Solid & brazed tips.</p> <p>Composition: 65% cBN bi-modal grain size distribution with average grain size of 6 μm and a TiCN ceramic binder.</p> <p>Coating: (Ti, Si)N coating.</p>
CH3515		<p>Format: Full-face layer and brazed tips (single sided).</p> <p>Composition: 90% cBN average grain size of 4 μm and a AlN ceramic binder.</p> <p>Coating: (Ti, Al)N coating.</p>
CBN300P		<p>Format: Solid.</p> <p>Composition: 90% cBN content grade with an average grain size of 22 μm and a Al ceramic binder.</p> <p>Coating: (Ti, Al)N coating.</p>
CK2065		<p>Format: Solid</p> <p>Composition: 90% cBN content grade with an average grain size of 22 mm and a Al ceramic binder.</p> <p>Coating: Wear detection coating</p>
CBN400C		<p>Format: Solid.</p> <p>Composition: 90% cBN content grade with an average grain size of 3-6 μm and a Al ceramic binder.</p> <p>Coating: (Ti, Si)N coating.</p>

General ISO Turning
Technical information

Steadyline®

MDT

Mini-Shaft™

Grooving

Parting-off

X4

Adapters
Clamping units

Accessories and
Spare parts

Workpiece
materials

General ISO Turning
Technical information

Steadyline®

MDT

Mini-Shaft™

Grooving

Parting-off

X4

Adapters
Clamping units

Accessories and
Spare parts

Workpiece
materials

PCBN grades, uncoated		
CBN010		<p>Format: Solid, full-face layer and brazed tips (single & double sided).</p> <p>Composition: 50% cBN content grade with an average grain size of 2 µm and a TiC ceramic binder.</p> <p>Coating: No coating.</p>
CBN150		<p>Format: Solid, full-face layer and brazed tips (single sided).</p> <p>Composition: 45% cBN content grade with an average grain size of < 1 µm and a TiCN ceramic binder.</p> <p>Coating: No coating.</p>
CBN170		<p>Format: Solid and brazed tips (double sided).</p> <p>Composition: 65% cBN content grade with an average grain size of 2 µm and a TiCN+SiCw ceramic binder.</p> <p>Coating: No coating.</p>
CBN200		<p>Format: Full-face layer and brazed tips (single sided).</p> <p>Composition: 85% cBN content grade with an average grain size of 2 µm and a Co-W-Al ceramic binder.</p> <p>Coating: No coating.</p>
CBN200		<p>Format: Solid.</p> <p>Composition: 90% cBN content grade with an average grain size of 3-6 µm and a Al ceramic binder.</p> <p>Coating: No coating.</p>
CBN300		<p>Format: Solid.</p> <p>Composition: 90% cBN content grade with an average grain size of 22 µm and a Al ceramic binder.</p> <p>Coating: No coating.</p>
CBN500		<p>Format: Solid.</p> <p>Composition: 90% cBN content grade with an average grain size of 15 µm and a Al ceramic binder.</p> <p>Coating: No coating.</p>
CBN600		<p>Format: Solid.</p> <p>Composition: 90% cBN content grade with multi modal grain size and Al ceramic binding.</p> <p>Coating: No coating.</p>

PCBN High Feed Wiper inserts – Introduction

The surface finish in a turning operation is affected by a great number of factors. Two of the most important factors are feed rate and the size of the corner radius. A relation commonly used in industry when choosing relevant cutting data regarding feed and surface finish, is that Ra roughly can be said to increase with the square of the feed rate and decrease with increased size of the corner radius. At least this was the case before the development of wiper geometries designed for high feed finishing, which is now gaining popularity in the metalworking industry. Wiper geometries changed this relationship with the capability to generate high surface finishes even at higher feed rates.

Seco High Feed Wiper inserts combine the high feed capability and high quality surface finish given by large round inserts and the low cutting forces and flexibility permitted by sharp pointed inserts. This can be achieved by the fact that the main part of the radial cutting force is generated by the main cutting edge. By transferring a small part of the round insert edges into the straight cutting edges of the pointed insert, an insert design adjusted for high feed machining producing superior surface finish is achieved.

General hints

- Use a High Feed Wiper insert to increase the feed without sacrificing surface finish, relative to conventional insert geometries.
- Use a High Feed Wiper insert to eliminate grinding operations. In many cases it is possible to obtain surface finishes and dimensional tolerances previously only possible with a final grinding operation.

Seco has four different types of wiper geometries designed for optimum performance in different applications:

- Conventional wiper -WZ
- Crossbill™ wiper -L-WZ and -R-WZ
- Helix™ wiper -WZN and -WZP
- Long/short wiper -WL/-WS

Conventional PCBN High Feed Wiper inserts

A conventional High Feed Wiper insert consists of a large radius added to the insert outside the nose radius. This wiper segment is added on both sides of the nose radius, allowing for turning left or right.

The Seco range of conventional High Feed Wiper products include all commonly used inserts shapes.

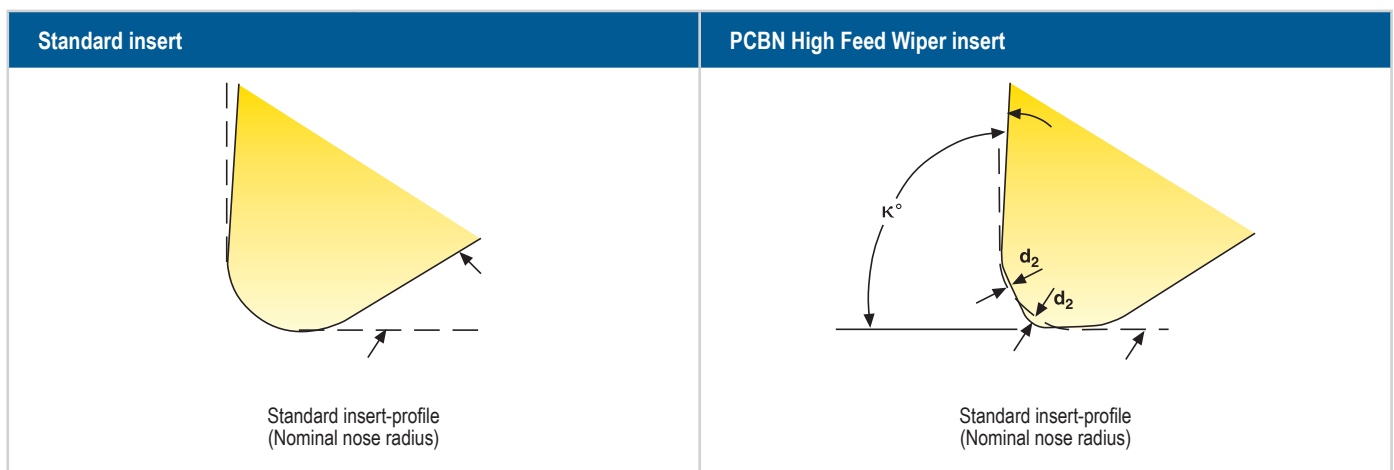

Seco Crossbill™ High Feed Wiper insert

A deviation from the normal radius shape will always occur when a standard wiper geometry is used to machine towards a corner/face.

The Crossbill High Feed Wiper insert gives the opportunity to produce a radius without deviation from the normal shape and without losing the advantages from a standard High Feed Wiper insert.

The Seco Crossbill™ High Feed Wiper inserts are available in PCBN grade CBN010 and CBN060K.

Design/Function

Axial turning (full wiper effect)

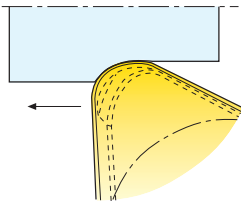

Facing (no wiper effect)

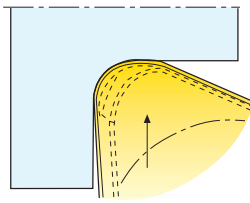

Copying (no deviation forming a radius)

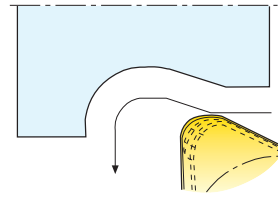

Right-hand version

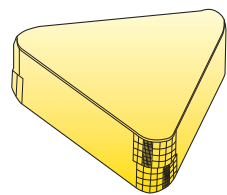

Wiper segment

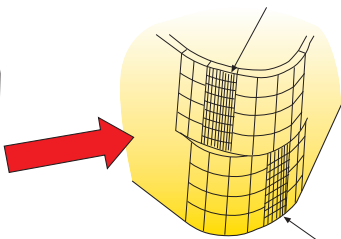

Wiper segment

Seco Helix™ High Feed Wiper insert

Our unique patented, Helix™ High Feed Wiper concept is designed for optimization in finish machining. It has a wiper on both sides of the corner radii (as the standard) but the protection chamfer is twisted from negative to positive or from positive to negative depending on the application.

It is available in grade CH0550, CBN060K and CBN010.

Design/Function

The following considerations apply when selecting the appropriate geometry:

Positive Wiper, WZP

- Reducing vibrations in weak set-ups
- Lower radial cutting forces
- Used where standard wiper cannot be used

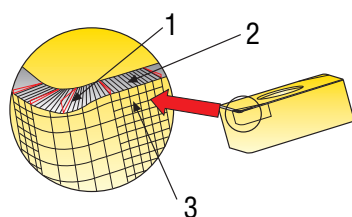

1. Big angle
2. Small angle
3. Wiper section

Negative Wiper, WZN

- Longer tool life
- Reducing vibrations in stable set-ups
- Increasing compressive stresses

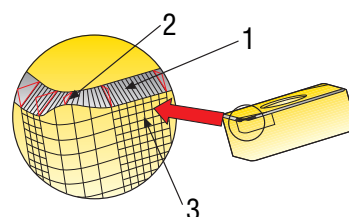

1. Big angle
2. Small angle
3. Wiper section

PCBN – Edge preparation

Edge preparation	
	<p> b_n = Chamfer width γ_n = Chamfer angle r_n = Hone radius </p>
Geometry recommendations	
<p>Strong cutting edge geometries are always preferred.</p> <ul style="list-style-type: none"> – Negative cutting geometry – Chamfered cutting edge – Large nose radius 	<p>Sharp positive cutting edge geometry can be advantageous when:</p> <ul style="list-style-type: none"> – Finishing of small hardened bores without interruptions – Finishing of unstable components without interruptions – Finishing of pearlitic grey cast iron

PCBN – Geometry

Edge preparation		Design	
E	= Honed	LF	= Complete top layer (full faced)
E25	= Extra honed, intended for Nickel-based superalloys	B	= Brazed tips (single sided), Insert geometry C, D and V
S	= Chamfered and honed	C	= Brazed tips (single sided), Insert geometry T and W
S25	= Chamfered and extra honed intended for PM material	D	= Brazed tips (single sided), Insert geometry S
WZ	= High Feed (Wiper) geometry	U	= Brazed tips (double sided), Insert geometry C, D and V
WZP	= High Feed (Wiper) geometry Positive	V	= Brazed tips (double sided), Insert geometry T and W
WZN	= High Feed (Wiper) geometry Negative		
WL	= High Feed (Wiper) geometry		
WS	= High Feed (Wiper) geometry		
Chamfer size and angle Solid CBN inserts		Chamfer size and angle Brazed & full faced CBN inserts	
CH0550	= 0,15 mm x 25°	CH0550	L1 = 0,10 mm x 15° L1 = 0,15 mm x 25°
CBN150	= 0,15 mm x 25°	CBN060K, CH2540	LF = 0,15 mm x 25° L1 = 0,15 mm x 25°
CBN060K	= 0,15 mm x 25°		L1 = 0,05 mm x 40°
CH2540	= 0,15 mm x 25°	CH3515	L1 = 0,20 mm x 20° LF = 0,20 mm x 20°
CK2065	= 0,20 mm x 20°		L1 = 0,10 mm x 20°
CBN400C	= 0,20 mm x 20°	CBN010	L2 = 0,20 mm x 20° LF = 0,10 mm x 20° LF-MDT = 0,10 mm x 25°
CBN010	= 0,10 mm x 20°		L1 = 0,20 mm x 20° (L1-WZ = 0,10mm x 20 °)
CBN200	= 0,20 mm x 20°	CBN200	L2 = 0,20 mm x 20° LF = 0,20 mm x 20° LF-MDT = 0,10 mm x 25° X4 = 0,10 mm x 20°
CBN300	= 0,20 mm x 20°		
CBN500	= 0,20 mm x 20°	CBN150	L1 = 0,15 mm x 25° (positive C-lock inserts, 0,10 mm x 20°)
CBN600	= 0,20 mm x 20°		LF = 0,15 mm x 25°
S-04015	= 0,40 mm x 15°		
X-05015	= 0,50 mm x 15°		

General ISO Turning
Technical information

Steadyline®

MDT

Mini-Shaft™

Grooving

Parting-off

X4

Adapters
Clamping units

Accessories and
Spare parts

Workpiece
materials

PCBN Chipbreaker inserts

The laser machined chipbreaker comes in two different styles, one for low and one for high feed applications. The non-wiper Secomax™ chipbreaker insert makes it possible to have good chip control when low feed rates are used. The wiper Secomax™ chipbreaker insert provides improved chip control when using high feed rates.

Secomax PCBN, non-wiper and wiper chipbreaker inserts

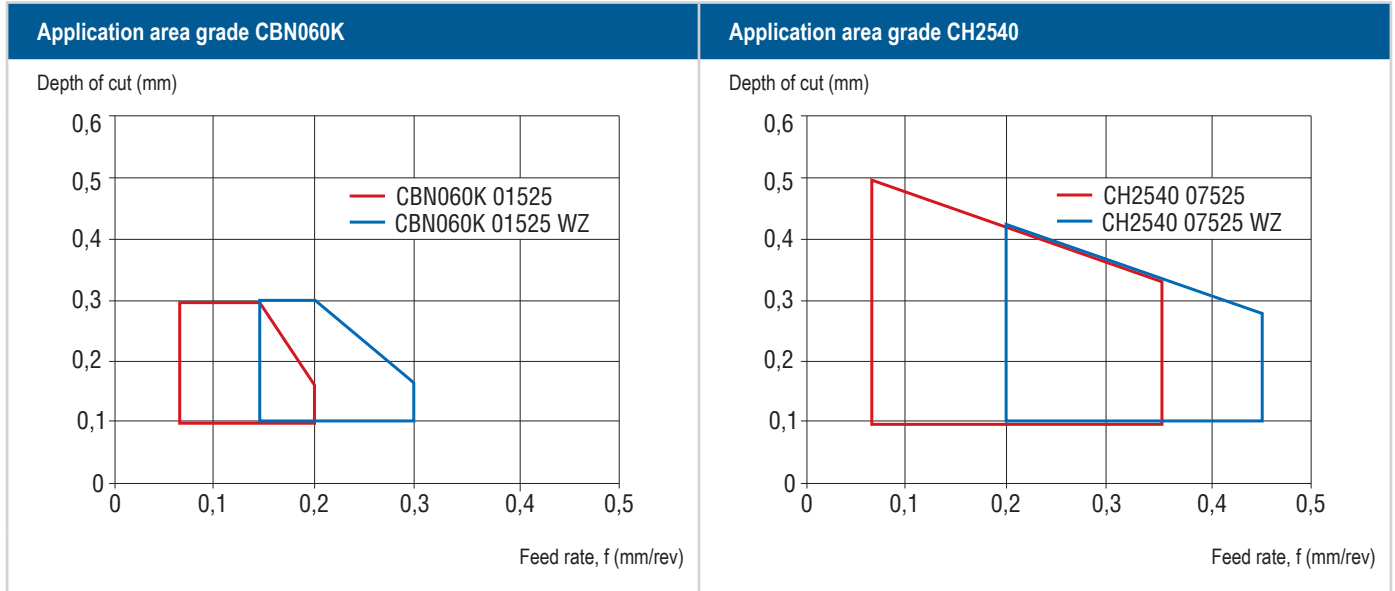

Laser machining provides several benefits over conventional production technologies such as grinding. Laser technology meets the highest requirements regarding dimensional accuracy, geometrical precision and surface quality for the machining of complex, three-dimensional geometries. These advantages and possibilities have led to a complex formed chipbreaker with "bumps" that would have been impossible to produce with any other production technology.



Plunge Turning

The vast majority of heat treated components in the metalworking industry are machined to their final geometrical form after hardening. Seco have developed a method in hard turning, the Seco patented Plunge Turning.

The plunging process consists of an orthogonal cut, using the solid CBN010, CBN150, CBN060K, CH0550 or CH2540.

Using the Plunge Turning method gives two great advantages compared to conventional hard turning, reduction in cutting time (up to 90%) and improved surface integrity.

Conventional Turning

F = Feed direction
W = Workpiece

Cutting time 5 seconds

General cutting data recommendation for Plunge Turning is $v_c = 200-400$ m/min / $656-1312$ sfm and $f = 0,04$ mm/rev / 0.0016 in/rev.

To avoid the cutting edge profile affecting surface finish, complete the operation with a small axial movement.

Plunge Turning

F = Feed direction
W = Workpiece
X = Set screws

Cutting time 0,5 seconds

In addition to the introduction of the Plunge Turning method there are also some standard toolholders. These toolholders have set screws which give the possibility to adjust the toolholder to an exact setting angle. The toolholders have a designation ending with – PL, and are available for inserts in sizes T..11 and T..16.

General ISO Turning
Technical information

Steadyline®

MDT

Mini-Shaft™

Grooving

Parting-off

X4

Adapters
Clamping units

Accessories and
Spare parts

Workpiece
materials

Maximum depth of cut recommendations

Round inserts

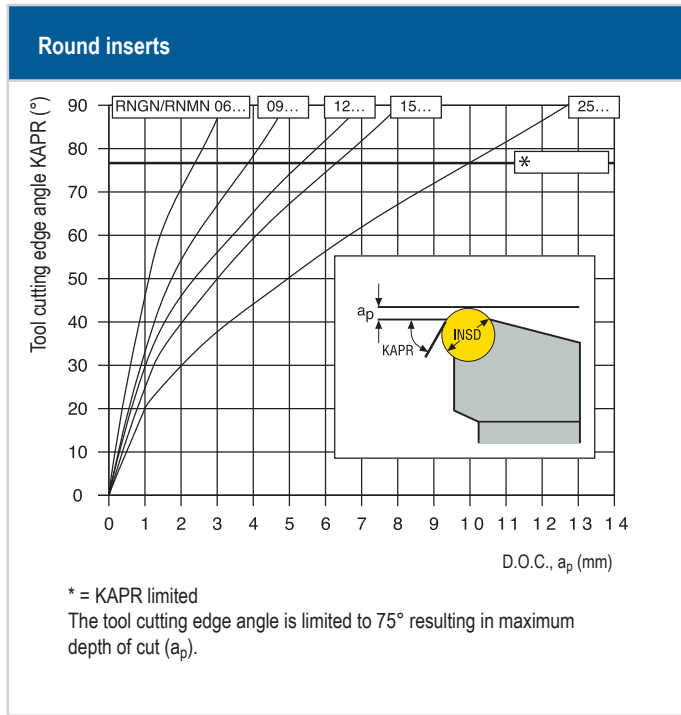

Max. D.O.C. a_p mm / inch	Number of usable cutting edges/side at 80% utilization		
	R...06	R...09	R...12
0,10 / 0.0039	20	24	–
0,15 / 0.0059	16	20	23
0,20 / 0.008	14	17	20
0,25 / 0.010	12	15	18
0,30 / 0.012	11	14	16
0,40 / 0.016	10	12	14
0,50 / 0.020	8	10	12
0,80 / 0.032	7	8	10
1,00 / 0.040	6	7	9
1,20 / 0.047	5	7	8
1,50 / 0.060	5	6	7
1,80 / 0.071	4	5	6
2,00 / 0.080	4	5	6
2,50 / 0.098	3	4	5
3,00 / 0.120	3	4	5
3,50 / 0.140	–	4	4
4,00 / 0.160	–	3	4
4,50 / 0.177	–	–	4
5,00 / 0.200	–	–	3

Other inserts

Type	Grade	Depth of cut a_p mm / inch
L1	CH0550	0,5 / 0.02
	CBN060K	0,5 / 0.02
	CH2540	0,5 / 0.02
	CH3515	1,0 / 0.04
	CBN170	0,5 / 0.02
	CBN010	0,5 / 0.02
	CBN150	0,5 / 0.02
	CBN200	1,0 / 0.04
L2	CBN010	0,5 / 0.02
LF	CBN010	0,5 / 0.02
	CBN150	0,5 / 0.02
	CBN200	30% of cutting edge length
Solid	CH3515	30% of cutting edge length
	CH0550	0,5 / 0.02
	CBN060K	0,5 / 0.02
	CH2540	0,5 / 0.02
	CBN010	0,5 / 0.02
	CBN150	0,5 / 0.02
	CK2065	30% of cutting edge length
	CBN200	30% of cutting edge length
	CBN300	30% of cutting edge length
	CBN400C	30% of cutting edge length
	CBN500	30% of cutting edge length
BN600	30% of cutting edge length	

MDT Type	Grade	Max. D.O.C. a_p mm / inch	
	-LF	CBN010	0,5 / 0.02
		CBN170	0,5 / 0.02
		CBN200	0,5 / 0.02
	M0-LF	CBN010	1,5 / 0.06
		CBN170	1,5 / 0.06
		CBN200	1,5 / 0.06

General ISO Turning
Technical information

Steadyline®

MDT

Mini-Shaft™

Grooving

Parting-off

X4

Adapters
Clamping units

Accessories and
Spare parts

Workpiece
materials

True tip length (TTL) in mm / inch per nose radius (RE) and tip type

Insert shape	Nose angle	RE = 0,2 / 0.008		RE = 0,4 / 0.016		RE = 0,8 / 0.032		RE = 1,2 / 0.047		RE = 1,6 / 0.063		RE = 2,0 / 0.080	
		L1	L2	L1	L2	L1	L2	L1	L2	L1	L2	L1	L2
C	80°	-	-	2,7 / 0.106	-	2,4 / 0.094	-	2,2 / 0.085	-	-	-	-	-
D	55°	3,5 / 0.140	-	3,2 / 0.126	-	2,7 / 0.106	-	2,2 / 0.085	-	-	-	-	-
S	90°	-	-	-	-	2,2 / 0.085	-	-	-	-	-	-	-
T	60°	-	-	2,6 / 0.100	-	2,2 / 0.085	-	1,8 / 0.071	-	1,4 / 0.055	-	1,8 / 0.071	-
V	35°	4,4 / 0.173	-	3,7 / 0.146	5,1 / 0.201	2,8 / 0.110	4,2 / 0.165	-	-	-	-	-	-
W	80°	-	-	-	-	2,2 / 0.085	-	1,9 / 0.075	-	-	-	-	-

MDT size	..-LF	..M0-LF
LC..13..	2,3 / 0.091	2,4 / 0.094
LC..1304..	2,4 / 0.094	2,4 / 0.094
LC 1603..	2,5 / 0.098	2,5 / 0.098
LC 1604..	2,5 / 0.098	3,1 / 0.122
LC 1605..	2,8 / 0.110	3,0 / 0.120
LC 1606..	3,2 / 0.126	3,0 / 0.120

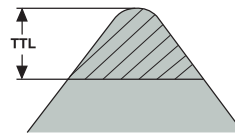

General ISO Turning
Technical information

Steadyline®

MDT

Mini-Shaft™

Grooving

Parting-off

X4

Adapters
Clamping units

Accessories and
Spare parts

Workpiece
materials

PCBN, SMG

Cast Irons

SMG	Description	Reference	Recommendations
K1	Grey cast irons (GCI)	EN-GJL-250	<p>First choice in dry machining: CBN300. Universal option: CBN600.</p> <p>First choice when coolant is used: CBN200. First choice for finish machining: CBN400C. Adjust the depth of cut to get under the casting skin and blow holes.</p>
K4	Nodular cast irons (SGI)	EN-GJS-500-7	<p>First choice for finish machining: CBN010.</p>

Superalloys and Titanium

SMG	Description	Reference	Recommendations
S1	Iron-based superalloys	Discalloy	<p>First choice for finish machining: CBN010 with E25 edge preparation. Use coolant.</p>
S2	Cobalt-based superalloys	Stellite 21	<p>First choice for finish machining: CBN010 with E25 edge preparation. Use coolant.</p>
S3	Nickel-based superalloys	Inconel 718	<p>PCBN tools can be used on Inconel 718 with following properties.</p> <p>Solution annealed + age hardened Direct age hardened</p> <p>Hardness 32 – 44 Hrc</p> <p>First choice for finish machining: CBN170. Use coolant.</p>

General ISO Turning
Technical information

Steadyline®

MDT

Mini-Shaft™

Grooving

Parting-off

X4

Adapters
Clamping units

Accessories and
Spare parts

Workpiece
materials

Hard Materials

SMG	Description	Reference	Recommendations
H3	Case-hardened steels	16 MnCr 5 60 HRC	<p>Dry machining is preferable. Coolant can be used. The chips should be fully annealed and brittle. First choice for finish machining: CH0550. Universal grade for finish machining: CBN010. For high surface finish requirements, use CBN150.</p> <p>In interrupted machining: Moderate interruptions, use CBN060K/CBN010. Aggressive interruptions, use CH2540/CH3515/CBN150. Reduce the feed rate. Machine without coolant. If possible, chamfer any sharp edges of the workpiece before machining.</p>
H5	Quenched & Tempered steels	42 CrMo 4 50 HRC	<p>Dry machining is preferable. Coolant can be used. The chips should be fully annealed and brittle. First choice for finish machining: CBN060K. Universal grade for finish machining: CBN010. For high surface finish requirements, use CH0550.</p> <p>In interrupted machining: Moderate interruptions, use CBN060K/CBN010. Aggressive interruptions, use CH2540/CH3515/CBN150. Reduce the feed rate. Machine without coolant. If possible, chamfer any sharp edges of the workpiece before machining.</p>
H7	Quenched & Tempered steels Bearing steels	100 Cr 6 60 HRC	<p>Dry machining is preferable. Coolant can be used. The chips should be fully annealed and brittle. First choice for finish machining: CBN060K. Universal grade for finish machining: CBN010. For rough machining, use CBN200/CBN300. For high surface finish requirements, use CH0550.</p> <p>In interrupted machining: Moderate interruptions, use CBN060K/CBN010. Aggressive interruptions, use CH2540/CH3515/CBN150. Reduce the feed rate. Machine without coolant. If possible, chamfer any sharp edges of the workpiece before machining.</p>
H8	Tool steels High Speed Steels (HSS)	X 40 CrMoV 5 1 50 HRC	<p>First choice for finish machining: CBN010. First choice for rough machining: CBN200. Interrupted machining of high speed steels can not be done.</p>
H11	Martensitic stainless steels	X 20 Cr 13 45 HRC	<p>First choice for finish machining: CBN010. First choice for rough machining: CBN300.</p> <p>In interrupted machining: Moderate interruptions, use CBN010. Aggressive interruptions, use CH2540/CH3515/CBN150.</p>
H21	Manganese steels	X 120 Mn 12 50 HRC	<p>First choice CBN300. When a tougher grade is needed use CBN500. Use chamfered inserts. Use stable toolholder and rigid clamping of the workpiece. Machine without coolant. Chamfer workpiece edges first.</p>
H31	White cast irons	EN-GJN- HV600(XCr11) 55 HRC	<p>Use CBN500 or when centerlock inserts are used CBN200. Universal option: CBN600. Adjust the depth of cut to get under the casting skin and blow holes. Dry machining is preferable.</p>

General ISO Turning
Technical information

Steadyline®

MDT

Mini-Shaft™

Grooving

Parting-off

X4

Adapters
Clamping units

Accessories and
Spare parts

Workpiece
materials

Other Difficult Materials

SMG	Description	Reference	Recommendations
PM1	Low-alloy PM-materials	F-0008 Fe-0.7C	<p>PCBN tools can be used on PM parts as soft as 25 HRC. The critical parameter is particle hardness, when the particle hardness exceeds 50 HRC, PCBN is useful, no matter what the bulk hardness is.</p> <p>First choice CBN200. Second choice CH3515. For rough machining CBN300 is an alternative. Use chamfered inserts, S25 edge preparation. Do not use coolant for interrupted cut.</p>
PM2	Medium-alloy PM-materials	FLC-4608 Fe2Cu1.8Ni 0.5Mo0.2Mn0.8C	<p>PCBN tools can be used on PM parts as soft as 25 HRC. The critical parameter is particle hardness, when the particle hardness exceeds 50 HRC, PCBN is useful, no matter what the bulk hardness is.</p> <p>First choice CBN200. Second choice CH3515. For rough machining CBN300 is an alternative. Use chamfered inserts, S25 edge preparation. Do not use coolant for interrupted cut.</p>
PM3	High-alloy PM-materials Exhaust valve seat materials, etc.		<p>First choice CBN150. Second choice CBN010. Use positive inserts. Use chamfered and honed edges for longer tool life. Use honed edges when tight tolerances are required. Machining can be carried out either with or without coolant.</p>
HF1	Hardfacing alloys Welded or plasma-deposited iron-based alloys		<p>Cr-based alloys – Hardness <60 HRC. Co-based alloys – Hardness >35 HRC. Ni-based alloys – Hardness >35 HRC. Fe-based alloys – Hardness >35 HRC.</p> <p>First choice for finish machining: CBN010. First choice for rough machining: CBN500, or when centerlock inserts are used: CBN200. Use round inserts if possible. Use chamfered inserts. Adjust the depth of cut to get under the welding skin and blow holes. Dry machining is preferable. Remove any weld spatter before machining.</p>
HF2	Hardfacing alloys Welded or plasma-deposited cobalt- and nickel-based alloys		<p>Cr-based alloys – Hardness <60 HRC. Co-based alloys – Hardness >35 HRC. Ni-based alloys – Hardness >35 HRC. Fe-based alloys – Hardness >35 HRC.</p> <p>First choice for finish machining: CBN010. First choice for rough machining: CBN500, or when centerlock inserts are used: CBN200. Use round inserts if possible. Use chamfered inserts. Adjust the depth of cut to get under the welding skin and blow holes. Dry machining is preferable. Remove any weld spatter before machining.</p>
CC1	Sintered tungsten carbide	G50	<p>Sintered tungsten carbide with a Co content >17%.</p> <p>Basic conditions: Use CBN300. When a tougher grade is needed use CBN500. Use round inserts. Use chamfered inserts. Machining with coolant is preferable. Chamfer the workpiece at entry and exit.</p>

General ISO Turning
Technical information

Steadyline®

MDT

Mini-Shaft™

Grooving

Parting-off

X4

Adapters
Clamping units

Accessories and
Spare parts

Workpiece
materials

PCBN, Finishing $a_p < 0,5 \text{ mm} / 0.020 \text{ Inch}$

SMG	CH0550		CBN060K		CH2540		CH3515	
	v_c	f	v_c	f	v_c	f	v_c	f
K1	—	—	—	—	—	—	500 — 1000	0,10 — 0,60
	—	—	—	—	—	—	1700 — 3200	0.00394 — 0.0236
K4	—	—	—	—	—	—	—	—
	—	—	—	—	—	—	—	—
H3	100 — 300	0,050 — 0,30	100 — 250	0,050 — 0,35	110 — 230	0,050 — 0,35	90 — 200	0,050 — 0,35
	330 — 980	0.00197 — 0.0118	330 — 820	0.00197 — 0.0137	370 — 750	0.00197 — 0.0137	300 — 650	0.00197 — 0.0137
H5	100 — 250	0,050 — 0,30	100 — 220	0,050 — 0,35	110 — 200	0,050 — 0,35	90 — 180	0,050 — 0,35
	330 — 820	0.00197 — 0.0118	330 — 720	0.00197 — 0.0137	370 — 650	0.00197 — 0.0137	300 — 590	0.00197 — 0.0137
H7	100 — 230	0,050 — 0,30	100 — 200	0,050 — 0,35	110 — 180	0,050 — 0,35	90 — 170	0,050 — 0,35
	330 — 750	0.00197 — 0.0118	330 — 650	0.00197 — 0.0137	370 — 590	0.00197 — 0.0137	300 — 550	0.00197 — 0.0137
H8	90 — 180	0,050 — 0,30	80 — 170	0,050 — 0,35	90 — 160	0,050 — 0,35	70 — 150	0,050 — 0,35
	300 — 590	0.00197 — 0.0118	270 — 550	0.00197 — 0.0137	300 — 520	0.00197 — 0.0137	230 — 490	0.00197 — 0.0137
H11	80 — 170	0,050 — 0,30	70 — 160	0,050 — 0,35	80 — 150	0,050 — 0,35	—	—
	270 — 550	0.00197 — 0.0118	230 — 520	0.00197 — 0.0137	270 — 490	0.00197 — 0.0137	—	—
PM1	—	—	—	—	—	—	100 — 250	0,050 — 0,30
	—	—	—	—	—	—	330 — 820	0.00197 — 0.0118
PM2	—	—	—	—	—	—	100 — 220	0,050 — 0,30
	—	—	—	—	—	—	330 — 720	0.00197 — 0.0118
PM3	100 — 170	0,050 — 0,15	—	—	—	—	—	—
	330 — 550	0.00197 — 0.00590	—	—	—	—	—	—
HF1	—	—	—	—	50 — 150	0,050 — 0,20	—	—
	—	—	—	—	170 — 490	0.00197 — 0.00787	—	—
HF2	—	—	—	—	100 — 200	0,050 — 0,20	—	—
	—	—	—	—	330 — 650	0.00197 — 0.00787	—	—

PCBN, Finishing $a_p < 0,5 \text{ mm} / 0.020 \text{ Inch}$

SMG	CBN010		CBN150		CBN170		CBN200	
	v_c	f	v_c	f	v_c	f	v_c	f
K1	—	—	—	—	—	—	500 — 1000	0,10 — 0,60
	—	—	—	—	—	—	1700 — 3200	0.00394 — 0.0236
K4	140 — 240	0,050 — 0,20	140 — 240	0,050 — 0,20	—	—	—	—
	460 — 780	0.00197 — 0.00787	460 — 780	0.00197 — 0.00787	—	—	—	—
S1	70 — 140	0,050 — 0,30	—	—	120 — 220	0,050 — 0,25	—	—
	230 — 450	0.00197 — 0.0118	—	—	400 — 720	0.00197 — 0.00984	—	—
S2	—	—	—	—	—	—	40 — 60	0,050 — 0,15
	—	—	—	—	—	—	140 — 190	0.00197 — 0.00590
S3	100 — 240	0,050 — 0,25	—	—	120 — 280	0,050 — 0,25	—	—
	330 — 780	0.00197 — 0.00984	—	—	400 — 910	0.00197 — 0.00984	—	—
H3	80 — 200	0,050 — 0,35	70 — 180	0,050 — 0,35	—	—	—	—
	270 — 650	0.00197 — 0.0137	230 — 590	0.00197 — 0.0137	—	—	—	—
H5	80 — 190	0,050 — 0,35	70 — 170	0,050 — 0,35	—	—	—	—
	270 — 620	0.00197 — 0.0137	230 — 550	0.00197 — 0.0137	—	—	—	—
H7	80 — 180	0,050 — 0,35	70 — 160	0,050 — 0,35	—	—	—	—
	270 — 590	0.00197 — 0.0137	230 — 520	0.00197 — 0.0137	—	—	—	—
H8	70 — 170	0,050 — 0,35	60 — 150	0,050 — 0,35	—	—	—	—
	230 — 550	0.00197 — 0.0137	200 — 490	0.00197 — 0.0137	—	—	—	—
H11	70 — 160	0,050 — 0,35	60 — 140	0,050 — 0,35	—	—	—	—
	230 — 520	0.00197 — 0.0137	200 — 450	0.00197 — 0.0137	—	—	—	—
PM1	—	—	—	—	—	—	100 — 220	0,050 — 0,30
	—	—	—	—	—	—	330 — 720	0.00197 — 0.0118
PM2	—	—	—	—	—	—	90 — 200	0,050 — 0,30
	—	—	—	—	—	—	300 — 650	0.00197 — 0.0118
PM3	80 — 170	0,050 — 0,15	80 — 150	0,050 — 0,15	—	—	—	—
	270 — 550	0.00197 — 0.00590	270 — 490	0.00197 — 0.00590	—	—	—	—
HF1	50 — 150	0,050 — 0,25	50 — 130	0,050 — 0,25	—	—	100 — 170	0,050 — 0,30
	170 — 490	0.00197 — 0.00984	170 — 420	0.00197 — 0.00984	—	—	330 — 550	0.00197 — 0.0118
HF2	60 — 190	0,050 — 0,25	60 — 170	0,050 — 0,25	—	—	170 — 250	0,050 — 0,30
	200 — 620	0.00197 — 0.00984	200 — 550	0.00197 — 0.00984	—	—	560 — 820	0.00197 — 0.0118

PCBN, Finishing $a_p < 0,5 \text{ mm} / 0.020 \text{ Inch}$

SMG	CBN300		CBN400C		CBN500		CBN600		CK2065	
	v_c	f	v_c	f	v_c	f	v_c	f	v_c	f
K1	500 – 1700 1700 – 5500	0,10 – 0,60 0.00394 – 0.0236	500 – 1800 1700 – 5900	0,10 – 0,60 0.00394 – 0.0236	500 – 1500 1700 – 4900	0,10 – 0,60 0.00394 – 0.0236	500 – 1300 1700 – 4200	0,10 – 0,60 0.00394 – 0.0236	500 – 1700 1700 – 5500	0,10 – 0,60 0.00394 – 0.0236
H21	130 – 250 430 – 820	0,10 – 0,60 0.00394 – 0.0236	— —	— —	150 – 270 500 – 880	0,10 – 0,60 0.00394 – 0.0236	120 – 220 400 – 720	0,10 – 0,60 0.00394 – 0.0236	130 – 250 430 – 820	0,10 – 0,60 0.00394 – 0.0236
H31	80 – 200 270 – 650	0,10 – 0,60 0.00394 – 0.0236	— —	— —	80 – 220 270 – 720	0,10 – 0,60 0.00394 – 0.0236	80 – 180 270 – 590	0,10 – 0,60 0.00394 – 0.0236	80 – 200 270 – 650	0,10 – 0,60 0.00394 – 0.0236
HF1	— —	— —	— —	— —	100 – 220 330 – 720	0,050 – 0,30 0.00197 – 0.0118	— —	— —	— —	— —
HF2	— —	— —	— —	— —	170 – 270 560 – 880	0,050 – 0,30 0.00197 – 0.0118	— —	— —	— —	— —
CC1	20 – 40 66 – 130	0,050 – 0,20 0.00197 – 0.00787	— —	— —	— —	— —	20 – 40 66 – 130	0,050 – 0,20 0.00197 – 0.00787	20 – 40 66 – 130	0,050 – 0,20 0.00197 – 0.00787

PCBN, Roughing $a_p 0,5 – 3,0 \text{ mm} / 0.020 – 0.120 \text{ Inch}$

SMG	CBN200		CBN300		CBN500		CBN600		CK2065	
	v_c	f	v_c	f	v_c	f	v_c	f	v_c	f
K1	500 – 1000 1700 – 3200	0,20 – 0,65 0.00788 – 0.0255	500 – 1500 1700 – 4900	0,20 – 0,70 0.00788 – 0.0275	500 – 1200 1700 – 3900	0,20 – 0,70 0.00788 – 0.0275	500 – 1200 1700 – 3900	0,20 – 0,70 0.00788 – 0.0275	500 – 1500 1700 – 4900	0,20 – 0,70 0.00788 – 0.0275
H7	70 – 150 230 – 490	0,10 – 0,50 0.00394 – 0.0196	90 – 180 300 – 590	0,10 – 0,50 0.00394 – 0.0196	90 – 180 300 – 590	0,10 – 0,60 0.00394 – 0.0236	70 – 150 230 – 490	0,10 – 0,55 0.00394 – 0.0216	90 – 180 300 – 590	0,10 – 0,50 0.00394 – 0.0196
H8	50 – 130 170 – 420	0,10 – 0,50 0.00394 – 0.0196	90 – 180 300 – 590	0,10 – 0,50 0.00394 – 0.0196	50 – 150 170 – 490	0,10 – 0,60 0.00394 – 0.0236	50 – 130 170 – 420	0,10 – 0,55 0.00394 – 0.0216	90 – 180 300 – 590	0,10 – 0,50 0.00394 – 0.0196
H21	— —	— —	130 – 230 430 – 750	0,10 – 0,60 0.00394 – 0.0236	150 – 250 500 – 820	0,10 – 0,60 0.00394 – 0.0236	120 – 200 400 – 650	0,10 – 0,60 0.00394 – 0.0236	130 – 230 430 – 750	0,10 – 0,60 0.00394 – 0.0236
H31	— —	— —	80 – 180 270 – 590	0,10 – 0,60 0.00394 – 0.0236	80 – 200 270 – 650	0,10 – 0,60 0.00394 – 0.0236	80 – 160 270 – 520	0,10 – 0,60 0.00394 – 0.0236	80 – 180 270 – 590	0,10 – 0,60 0.00394 – 0.0236
PM1	100 – 200 330 – 650	0,10 – 0,30 0.00394 – 0.0118	100 – 220 330 – 720	0,10 – 0,30 0.00394 – 0.0118	— —	— —	100 – 220 330 – 720	0,10 – 0,30 0.00394 – 0.0118	100 – 220 330 – 720	0,10 – 0,30 0.00394 – 0.0118
PM2	90 – 180 300 – 590	0,10 – 0,30 0.00394 – 0.0118	100 – 200 330 – 650	0,10 – 0,30 0.00394 – 0.0118	— —	— —	100 – 200 330 – 650	0,10 – 0,30 0.00394 – 0.0118	100 – 200 330 – 650	0,10 – 0,30 0.00394 – 0.0118
HF1	100 – 150 330 – 490	0,10 – 0,30 0.00394 – 0.0118	— —	— —	100 – 200 330 – 650	0,10 – 0,60 0.00394 – 0.0236	— —	— —	— —	— —
HF2	170 – 230 560 – 750	0,10 – 0,30 0.00394 – 0.0118	— —	— —	170 – 250 560 – 820	0,10 – 0,60 0.00394 – 0.0236	— —	— —	— —	— —
CC1	— —	— —	20 – 30 66 – 98	0,050 – 0,20 0.00197 – 0.00787	— —	— —	20 – 30 66 – 98	0,050 – 0,20 0.00197 – 0.00787	20 – 30 66 – 98	0,050 – 0,20 0.00197 – 0.00787

General ISO Turning
Technical information

Steadyline®

MDT

Mini-Shaft™

Grooving

Parting-off

X4

Adapters
Clamping units

Accessories and
Spare parts

Workpiece
materials

PCBN, Plunging

SMG	CH0550		CBN060K		CH2540		CBN010	
	v _c	f	v _c	f	v _c	f	v _c	f
K1	—	—	—	—	—	—	—	—
H3	180 — 330 600 — 1000	0,0300 — 0,13 0.00119 — 0.0051	170 — 300 560 — 980	0,0300 — 0,13 0.00119 — 0.0051	170 — 280 560 — 910	0,0300 — 0,13 0.00119 — 0.0051	160 — 320 530 — 1000	0,0300 — 0,13 0.00119 — 0.0051
H5	180 — 310 600 — 1000	0,0300 — 0,13 0.00119 — 0.0051	170 — 280 560 — 910	0,0300 — 0,13 0.00119 — 0.0051	170 — 260 560 — 850	0,0300 — 0,13 0.00119 — 0.0051	160 — 300 530 — 980	0,0300 — 0,13 0.00119 — 0.0051
H7	180 — 280 600 — 910	0,0300 — 0,13 0.00119 — 0.0051	170 — 260 560 — 850	0,0300 — 0,13 0.00119 — 0.0051	170 — 240 560 — 780	0,0300 — 0,13 0.00119 — 0.0051	160 — 370 530 — 1200	0,0300 — 0,13 0.00119 — 0.0051
H8	150 — 200 500 — 650	0,0300 — 0,13 0.00119 — 0.0051	140 — 230 460 — 750	0,0300 — 0,13 0.00119 — 0.0051	140 — 210 460 — 680	0,0300 — 0,13 0.00119 — 0.0051	130 — 200 430 — 650	0,0300 — 0,13 0.00119 — 0.0051
H11	—	—	—	—	—	—	—	—
H21	—	—	—	—	—	—	—	—
H31	—	—	—	—	—	—	—	—
PM1	—	—	—	—	—	—	—	—
PM2	—	—	—	—	—	—	—	—
PM3	130 — 260 430 — 850	0,0300 — 0,13 0.00119 — 0.0051	—	—	—	—	110 — 230 370 — 750	0,0300 — 0,13 0.00119 — 0.0051
HF1	—	—	—	—	—	—	—	—
HF2	—	—	—	—	—	—	—	—
CC1	—	—	—	—	—	—	—	—

PCBN, Plunging

SMG	CBN200	
	v _c	f
K1	—	—
S1	—	—
S2	—	—
S3	—	—
H3	—	—
H5	—	—
H7	—	—
H8	—	—
H11	—	—
H21	—	—
H31	—	—
PM1	200 — 350 660 — 1100	0,0300 — 0,13 0.00119 — 0.0051
PM2	150 — 300 500 — 980	0,0300 — 0,13 0.00119 — 0.0051
PM3	—	—
HF1	—	—
HF2	—	—
CC1	—	—

PCBN, Grooving

SMG	CBN010		CBN170		CBN200	
	v _c	f	v _c	f	v _c	f
K1	—	—	—	—	500 — 1000	0,0300 — 0,15
	—	—	—	—	1700 — 3200	0.00119 — 0.00590
S1	70 — 140	0,0300 — 0,15	120 — 220	0,0300 — 0,15	—	—
	230 — 450	0.00119 — 0.00590	400 — 720	0.00119 — 0.00590	—	—
S2	—	—	—	—	40 — 60	0,0300 — 0,15
	—	—	—	—	140 — 190	0.00119 — 0.00590
S3	100 — 240	0,0300 — 0,15	120 — 280	0,0300 — 0,15	—	—
	330 — 780	0.00119 — 0.00590	400 — 910	0.00119 — 0.00590	—	—
H3	80 — 200	0,0300 — 0,15	—	—	—	—
	270 — 650	0.00119 — 0.00590	—	—	—	—
H5	80 — 190	0,0300 — 0,15	—	—	—	—
	270 — 620	0.00119 — 0.00590	—	—	—	—
H7	80 — 180	0,0300 — 0,15	—	—	—	—
	270 — 590	0.00119 — 0.00590	—	—	—	—
H8	70 — 170	0,0300 — 0,15	—	—	—	—
	230 — 550	0.00119 — 0.00590	—	—	—	—
H11	70 — 160	0,0300 — 0,15	—	—	—	—
	230 — 520	0.00119 — 0.00590	—	—	—	—
H21	—	—	—	—	—	—
	—	—	—	—	—	—
H31	—	—	—	—	80 — 220	0,0300 — 0,15
	—	—	—	—	270 — 720	0.00119 — 0.00590
PM1	—	—	—	—	100 — 180	0,0300 — 0,15
	—	—	—	—	330 — 590	0.00119 — 0.00590
PM2	—	—	—	—	90 — 160	0,0300 — 0,15
	—	—	—	—	300 — 520	0.00119 — 0.00590
PM3	—	—	—	—	—	—
	—	—	—	—	—	—
HF1	—	—	—	—	100 — 170	0,0300 — 0,15
	—	—	—	—	330 — 550	0.00119 — 0.00590
HF2	—	—	—	—	170 — 250	0,0300 — 0,15
	—	—	—	—	560 — 820	0.00119 — 0.00590

- General ISO Turning Technical information
- Steadyline®
- MDT
- Mini-Shaft™
- Grooving
- Parting-off
- X4
- Adapters Clamping units
- Accessories and Spare parts
- Workpiece materials

Selection of insert format – PCD

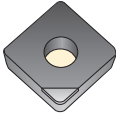
Sintered layer -LF	
	<p>PCD sintered on carbide. All cutting edges on one side are usable.</p> <p>Grade: PCD30</p> <p>Toolholder style: C</p>
Brazed tip insert -L1	
	<p>PCD brazed on to standard carbide inserts.</p> <p>Grades: PCD20, PCD30</p> <p>Toolholder styles: D, P, M and C</p>

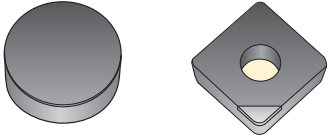
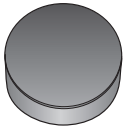
PCD grades, uncoated		
PCD20		<p>Format: Full-face sintered layer and brazed tips (single sided).</p> <p>Composition: Grade with an average grain size of 10 µm and a Co binder.</p> <p>Coating: No coating.</p>
PCD30		<p>Format: Full-face sintered layer (single sided).</p> <p>Composition: Grade with an average grain size of 25 µm and a Co binder.</p> <p>Coating: No coating.</p>

PCD – Edge preparation

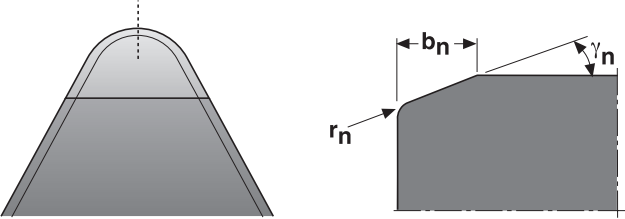
Edge preparation	
	<p>b_n = Chamfer width γ_n = Chamfer angle r_n = Hone radius</p>
Geometry recommendations	Edge preparation
A sharp cutting edge is always recommended.	F = Sharp cutting edge

PCD, SMG

Non Ferrous Metals

SMG	Description	Reference	Recommendations
N1	Aluminium alloys, Si < 9%	AW-7075	First choice for finish and rough machining: PCD20.
N2	Aluminium alloys, 9% < Si < 16%	AC-44200 Si = 12%	First choice for finish and rough machining: PCD20.
N3	Aluminium alloys, Si >16%	AlSi17Cu5	First choice for finish and rough machining: PCD30.
N11	Copper alloys	CW614N	First choice for finish and rough machining: PCD20.

Other Difficult Materials

SMG	Description	Reference	Recommendations
CC1	Sintered tungsten carbide	G50	First choice for finish machining: PCD30.

Plastics and Composites

SMG	Description	Reference	Recommendations
TS1	Thermosetting polymers	Urea formaldehyde (UF)	First choice for finish and rough machining: PCD20.
TS2	Thermosetting carbon-fibre composites	T300 T700 T800 HTA-S IMA - Epoxy (M21)...	First choice for finish and rough machining: PCD20.
TS3	Thermosetting glass-fibre composites	Epoxy - HX..(42..)/E glass (7781...)...	First choice for finish and rough machining: PCD20.
TS4	Thermosetting aramide-fibre composites	Kevlar 49	First choice for finish and rough machining: PCD20.
TP1	Thermoplastic polymers	Polycarbonate (PC)	First choice for finish and rough machining: PCD20.
TP2	Thermoplastic carbon-fibre composites	PPS/PEEK - T300..	First choice for finish and rough machining: PCD20.
TP3	Thermoplastic glass-fibre composites	PPS/PEEK - E glass or A glass...	First choice for finish and rough machining: PCD20.
TP4	Thermoplastic aramide-fibre composites		First choice for finish and rough machining: PCD20.

Graphites

SMG	Description	Reference	Recommendations
GR1	Graphite	R 8500	First choice for finish- and rough machining: PCD20.

PCD, Roughing a_p 0,5 – 3,0 mm / 0.020 – 0.120 Inch

SMG	PCD20		PCD30		PCD30M	
	v_c	f	v_c	f	v_c	f
N1	600 – 3500	0,050 – 0,30	—	—	—	—
	2000 – 11400	0.00197 – 0.0118	—	—	—	—
N2	450 – 2500	0,050 – 0,20	—	—	—	—
	1500 – 8200	0.00197 – 0.00787	—	—	—	—
N3	300 – 1000	0,050 – 0,10	300 – 1000	0,10 – 0,40	300 – 1000	0,10 – 0,40
	990 – 3200	0.00197 – 0.00393	990 – 3200	0.00394 – 0.0157	990 – 3200	0.00394 – 0.0157
N11	600 – 1200	0,10 – 0,50	600 – 1200	0,10 – 0,50	600 – 1200	0,10 – 0,50
	2000 – 3900	0.00394 – 0.0196	2000 – 3900	0.00394 – 0.0196	2000 – 3900	0.00394 – 0.0196
TS1	100 – 1500	0,10 – 0,40	—	—	—	—
	330 – 4900	0.00394 – 0.0157	—	—	—	—
TS2	400 – 800	0,10 – 0,20	400 – 800	0,10 – 0,20	400 – 800	0,10 – 0,20
	1400 – 2600	0.00394 – 0.00787	1400 – 2600	0.00394 – 0.00787	1400 – 2600	0.00394 – 0.00787
TS3	100 – 800	0,050 – 0,20	100 – 800	0,050 – 0,20	100 – 800	0,050 – 0,20
	330 – 2600	0.00197 – 0.00787	330 – 2600	0.00197 – 0.00787	330 – 2600	0.00197 – 0.00787
TS4	400 – 800	0,10 – 0,20	400 – 800	0,10 – 0,20	400 – 800	0,10 – 0,20
	1400 – 2600	0.00394 – 0.00787	1400 – 2600	0.00394 – 0.00787	1400 – 2600	0.00394 – 0.00787
TP1	100 – 1500	0,10 – 0,40	—	—	—	—
	330 – 4900	0.00394 – 0.0157	—	—	—	—
TP2	400 – 800	0,10 – 0,20	400 – 800	0,10 – 0,20	400 – 800	0,10 – 0,20
	1400 – 2600	0.00394 – 0.00787	1400 – 2600	0.00394 – 0.00787	1400 – 2600	0.00394 – 0.00787
TP3	100 – 800	0,050 – 0,20	100 – 800	0,050 – 0,20	100 – 800	0,050 – 0,20
	330 – 2600	0.00197 – 0.00787	330 – 2600	0.00197 – 0.00787	330 – 2600	0.00197 – 0.00787
TP4	400 – 800	0,10 – 0,20	400 – 800	0,10 – 0,20	400 – 800	0,10 – 0,20
	1400 – 2600	0.00394 – 0.00787	1400 – 2600	0.00394 – 0.00787	1400 – 2600	0.00394 – 0.00787
GR1	100 – 1500	0,10 – 0,20	—	—	—	—
	330 – 4900	0.00394 – 0.00787	—	—	—	—

PCD, Finishing a_p < 0,5 mm / 0.020 Inch

SMG	PCD20		PCD30		PCD30M	
	v_c	f	v_c	f	v_c	f
N1	600 – 3500	0,050 – 0,30	—	—	—	—
	2000 – 11400	0.00197 – 0.0118	—	—	—	—
N2	450 – 2500	0,050 – 0,20	—	—	—	—
	1500 – 8200	0.00197 – 0.00787	—	—	—	—
N3	300 – 1000	0,050 – 0,10	300 – 1000	0,10 – 0,40	300 – 1000	0,10 – 0,40
	990 – 3200	0.00197 – 0.00393	990 – 3200	0.00394 – 0.0157	990 – 3200	0.00394 – 0.0157
N11	600 – 1200	0,10 – 0,50	600 – 1200	0,10 – 0,50	600 – 1200	0,10 – 0,50
	2000 – 3900	0.00394 – 0.0196	2000 – 3900	0.00394 – 0.0196	2000 – 3900	0.00394 – 0.0196
CC1	—	—	10 – 20	0,050 – 0,15	10 – 20	0,050 – 0,15
	—	—	33 – 65	0.00197 – 0.00590	33 – 65	0.00197 – 0.00590
TS1	100 – 1500	0,10 – 0,40	—	—	—	—
	330 – 4900	0.00394 – 0.0157	—	—	—	—
TS2	400 – 800	0,10 – 0,20	400 – 800	0,10 – 0,20	400 – 800	0,10 – 0,20
	1400 – 2600	0.00394 – 0.00787	1400 – 2600	0.00394 – 0.00787	1400 – 2600	0.00394 – 0.00787
TS3	100 – 800	0,050 – 0,20	100 – 800	0,050 – 0,20	100 – 800	0,050 – 0,20
	330 – 2600	0.00197 – 0.00787	330 – 2600	0.00197 – 0.00787	330 – 2600	0.00197 – 0.00787
TS4	400 – 800	0,10 – 0,20	400 – 800	0,10 – 0,20	400 – 800	0,10 – 0,20
	1400 – 2600	0.00394 – 0.00787	1400 – 2600	0.00394 – 0.00787	1400 – 2600	0.00394 – 0.00787
TP1	100 – 1500	0,10 – 0,40	—	—	—	—
	330 – 4900	0.00394 – 0.0157	—	—	—	—
TP2	400 – 800	0,10 – 0,20	400 – 800	0,10 – 0,20	400 – 800	0,10 – 0,20
	1400 – 2600	0.00394 – 0.00787	1400 – 2600	0.00394 – 0.00787	1400 – 2600	0.00394 – 0.00787
TP3	100 – 800	0,050 – 0,20	100 – 800	0,050 – 0,20	100 – 800	0,050 – 0,20
	330 – 2600	0.00197 – 0.00787	330 – 2600	0.00197 – 0.00787	330 – 2600	0.00197 – 0.00787
TP4	400 – 800	0,10 – 0,20	400 – 800	0,10 – 0,20	400 – 800	0,10 – 0,20
	1400 – 2600	0.00394 – 0.00787	1400 – 2600	0.00394 – 0.00787	1400 – 2600	0.00394 – 0.00787
GR1	100 – 1500	0,10 – 0,20	—	—	—	—
	330 – 4900	0.00394 – 0.00787	—	—	—	—

Selection of insert format – Ceramic

Ceramic inserts are only available in solid format.

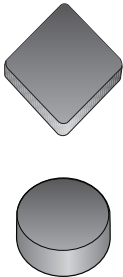
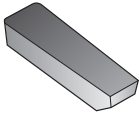
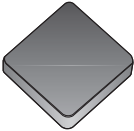
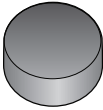
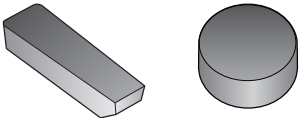
Solid insert		
		<p>According to the geometry, two sides can be used.</p> <p>Grade: CS100, CS300, CW100</p> <p>Toolholder style: C</p>
Solid insert		
		<p>According to the geometry, one edge can be used.</p> <p>Grade: CW100</p> <p>Toolholder style: CFxx</p>
Ceramic grades, uncoated		
CS100		<p>Format: Solid.</p> <p>Composition: Sialon (Si, Al, O, N) ceramic grade.</p> <p>Coating: No coating.</p>
CS300		<p>Format: Solid.</p> <p>Composition: Sialon (Si, Al, O, N) ceramic grade.</p> <p>Coating: No coating.</p>
CW100		<p>Format: Solid.</p> <p>Composition: Aluminium oxide (Al₂O₃) + SiC-whisker reinforced ceramic grade.</p> <p>Coating: No coating.</p>

Ceramics – Edge preparation

Edge preparation

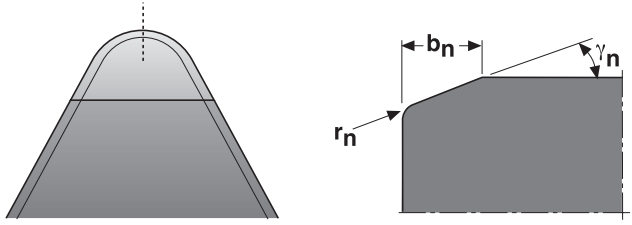

b_n = Chamfer width
 γ_n = Chamfer angle
 r_n = Hone radius

Geometry recommendations	Edge preparation	Chamfer size and angle
Strong cutting edge geometries are always preferred. – Negative cutting geometry – Chamfered cutting edge – Large nose radius	S = Chamfered and honed T = Chamfered, no honing E = Honed	CS100 = T or S = 0,10 mm x 20° CS300 = T = 0,10 mm x 20° CW100 = Honed or T = 0,10 mm x 20°

- General ISO Turning Technical information
- Steadyline®
- MDT
- Mini-Shaft™
- Grooving
- Parting-off
- X4
- Adapters Clamping units
- Accessories and Spare parts
- Workpiece materials

Ceramics, SMG

Superalloys

SMG	Description	Reference	Recommendations
S1	Iron-based superalloys	Discalloy	First choice for rough machining: CS100 First choice for grooving: CW100 Use coolant
S2	Cobalt-based superalloys	Stellite 21	First choice for rough machining: CS100 First choice for grooving: CW100 Use coolant
S3	Nickel-based superalloys	Inconel 718	First choice for rough machining: CS100 First choice for grooving: CW100 Use coolant

General ISO Turning
Technical information

Steadyline®

MDT

Mini-Shaft™

Grooving

Parting-off

X4

Adapters
Clamping units

Accessories and
Spare parts

Workpiece
materials

Ceramic, Roughing a_p 0,5 – 3,0 mm / 0.020 – 0.120 Inch – Cutting data and application area for CS100 is also applicable for CS300

SMG	CS100		CW100	
	v_c	f	v_c	f
S1	150 – 300	0,10 – 0,40	150 – 300	0,10 – 0,40
	500 – 980	0.00394 – 0.0157	500 – 980	0.00394 – 0.0157
S2	150 – 300	0,10 – 0,40	150 – 300	0,10 – 0,40
	500 – 980	0.00394 – 0.0157	500 – 980	0.00394 – 0.0157
S3	150 – 300	0,10 – 0,40	150 – 300	0,10 – 0,40
	500 – 980	0.00394 – 0.0157	500 – 980	0.00394 – 0.0157

Ceramic, Grooving

SMG	CW100	
	v_c	f
S1	150 – 300	0,050 – 0,10
	500 – 980	0.00197 – 0.00393
S2	150 – 300	0,050 – 0,10
	500 – 980	0.00197 – 0.00393
S3	150 – 300	0,050 – 0,10
	500 – 980	0.00197 – 0.00393

- General ISO Turning
Technical information
- Steadyline®
- MDT
- Mini-Shaft™
- Grooving
- Parting-off
- X4
- Adapters
Clamping units
- Accessories and
Spare parts
- Workpiece
materials



General ISO Turning holders for general turning machining

Seco offers a wide product range of ISO Turning holders. Jetstream Tooling® toolholders deliver coolant effectively through the toolholder to the optimum position close to the cutting edge. This improves chip control by lifting the chip away from the rake face and reducing the heat load, enabling longer tool life and drastically increasing cutting data to be applied. A comprehensive range of insert types, shapes and sizes are available.

- D Toolholder, first choice for stable clamping in general machining
- P Toolholder, complement reliable clamping in general machining e.g. more chip space required
- C Toolholder, designed mainly for SECO PCBN and Ceramic inserts without hole
- S Toolholder, first choice mainly for smaller inserts in general machining

Toolholders for QC-heads – Metric

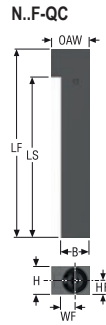





- QC = Quick Change modular toolholder
- CTWS = QC size
- Please check availability at www.secotools.com / Seco Online Store

Designation	Item number	CTWS	H	B	OAW	WF	HF	LF	LS	Weight
			mm	mm	mm	mm	mm	mm	mm	kg
N1010F-QC12	03280749	QC12	10	11	16,0	6,0	5,0	80,0	68,0	0,1
N1212F-QC12	03280750	QC12	12	12	16,0	6,0	6,0	80,0	68,0	0,1

Spare Parts

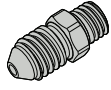
For size	Locking screw	Plug
QC12	 LSQ6065-T15P	 JET-M8X1.0

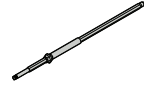
Accessories

For size	Coolant adapter	Insert clamping torque	Replacement blade	Torque key
QC12	 JET-ADM8-1.0	 4.0NM	 T00-15P	 T00-15P40

General ISO Turning Holders
 Steadyline®
 MDT
 Mini-Shaft™
 Grooving
 Parting-off
 X4
 Adapters Clamping units
 Accessories and Spare parts
 Workpiece materials

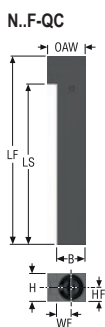

Toolholders for QC-heads – Metric/ Inch





- QC = Quick Change modular toolholder
- This metric denomination corresponds to a N065F-QC16 or ANSI size 10 shank
- CTWS = QC size
- Please check availability at www.secotools.com / Seco Online Store

Designation	Item number	CTWS	H	B	OAW	WF	HF	LF	LS	Weight
			mm Inch	mm Inch	mm Inch	mm Inch	mm Inch	mm Inch	mm Inch	
N1616F-QC16	03280751	QC16	16 0.630	16 0.630	18,0 0.709	8,0 0.315	8,0 0.315	80,0 3.150	68,0 2.677	0,2 0.440

Spare Parts

For size	Locking screw	Plug
QC16	 LSQ6065-T15P	 JET-P1/8-5MM

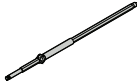
Accessories

For size	Insert clamping torque	Replacement blade	Torque key
QC16	 4.0NM	 T00-15P	 T00-15P40

General ISO Turning Holders

Steadyline®

MDT

Mini-Shaft™

Grooving

Parting-off

X4

Adapters Clamping units

Accessories and Spare parts

Workpiece materials

Toolholders for QC-heads – Inch

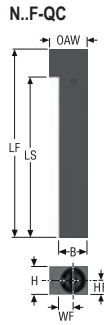

- QC = Quick Change modular toolholder
- CTWS = QC size
- Please check availability at www.secotools.com / Seco Online Store

Designation	Item number	CTWS	H	B	OAW	WF	HF	LF	LS	Weight
			<i>Inch</i>	<i>Inch</i>	<i>Inch</i>	<i>Inch</i>	<i>Inch</i>	<i>Inch</i>	<i>Inch</i>	<i>lbs</i>
N0375F-QC12	03280752	QC12	0.375	0.424	0.630	0.236	0.187	3.150	2.677	0.220
N050F-QC12	03280753	QC12	0.500	0.486	0.644	0.236	0.264	3.150	2.677	0.220

Spare Parts

For size	Locking screw	Plug
	LSQ6065-T15P	JET-M8X1.0

Accessories

For size	Coolant adapter	Insert clamping torque	Replacement blade	Torque key
	JET-ADM8-1.0	4.0NM	T00-15P	T00-15P40

General ISO Turning Holders
 Steadyline®
 MDT
 Mini-Shaft™
 Grooving
 Parting-off
 X4
 Adapters Clamping units
 Accessories and Spare parts
 Workpiece materials

QC-SCLCR/L-JET – ISO Turning, QC-heads for inserts CCGT, CCGW, CCGX, CCMT and CCMW – Metric/ Inch

KAPR = 95,0°

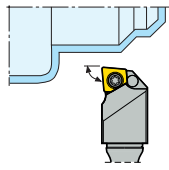

QC-SCLCR/L-JET

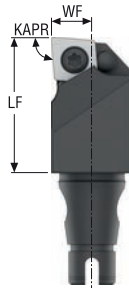





CTWS





- For inserts program, see page(s) 522, 523, 524, 525, 573, 574, 599
- For more information on Jetstream Tooling® (High pressure coolant) and accessories, please see page(s) 38, 85-89, 1002
- GAMO° = Rake angle, LAMS° = Inclination angle
- CTMS = QC size
- CTWS = Insert shape and size
- For holder code key, see page(s) 11-12
- * Max coolant pressure
- ** Jetstream Tooling® Duo, see page(s) 38, 85-89
- Right-hand version shown
- Please check availability at www.secotools.com / Seco Online Store

Designation	Item number	CTMS	**	WF	LF	HF	CP*	KAPR°	GAMO°	LAMS°	Weight	CTWS
				mm Inch	mm Inch	mm Inch	bar psi				kg lbs	
QC12-SCLCR-06JET	03280836	QC12	-	6,0 0.234	20 0.787	6,0 0.235	200,0 2900.8	95,0	0,0	0,0	0,3 0.660	CC..0602.. CC..21.5
QC12-SCLCL-06JET	03280839	QC12	-	6,0 0.234	20 0.787	6,0 0.235	200,0 2900.8	95,0	0,0	0,0	0,3 0.660	CC..0602.. CC..21.5
QC12-SCLCR-09JET	03280754	QC12	-	6,0 0.234	22 0.866	6,0 0.235	200,0 2900.8	95,0	0,0	0,0	0,3 0.660	CC..09T3.. CC..32.5
QC12-SCLCL-09JET	03280755	QC12	-	6,0 0.234	22 0.866	6,0 0.235	200,0 2900.8	95,0	0,0	0,0	0,3 0.660	CC..09T3.. CC..32.5
QC16-SCLCR-09JET	03280756	QC16	Duo	8,0 0.313	24 0.945	7,9 0.311	200,0 2900.8	95,0	0,0	0,0	0,3 0.660	CC..09T3.. CC..32.5
QC16-SCLCL-09JET	03280757	QC16	Duo	8,0 0.313	24 0.945	7,9 0.311	200,0 2900.8	95,0	0,0	0,0	0,3 0.660	CC..09T3.. CC..32.5

Spare Parts

For size	Insert key	Insert screw
..-06	 T07P-2	 C02506-T07P
..-09	 T15P-2	 C04008-T15P

Accessories

For size	Insert clamping torque	Mounting fixture	Torque key
..-06	 0.9NM	 SECO-MF7075-QC	 T00-07P09
..-09	3.5NM	SECO-MF7075-QC	T00-15P35

General ISO Turning Holders
Steadyline®
MDT
Mini-Shaft™
Grooving
Parting-off
X4
Adapters Clamping units
Accessories and Spare parts
Workpiece materials

QC-SDJCR/L-JET – ISO Turning, QC-heads for inserts DCGT, DCGW, DCMT, DCMW and DCMX – Metric/ Inch



QC-SDJCR/L-JET

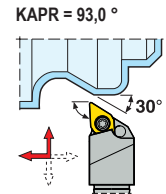
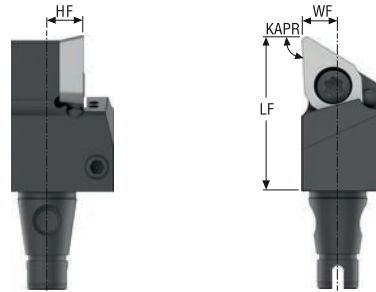

CTWS



- For inserts program, see page(s) 534, 535, 536, 578, 600
- For more information on Jetstream Tooling® (High pressure coolant) and accessories, please see page(s) 38, 85-89, 1002
- GAMO° = Rake angle, LAMS° = Inclination angle
- CTMS = QC size
- CTWS = Insert shape and size
- For holder code key, see page(s) 11-12
- * Max coolant pressure
- ** Jetstream Tooling® Duo, see page(s) 38, 85-89
- Right-hand version shown
- Please check availability at www.secotools.com / Seco Online Store

Designation	Item number	CTMS	**	WF	LF	HF	CP*	KAPR°	GAMO°	LAMS°	Weight	CTWS
				mm Inch	mm Inch	mm Inch	bar psi				kg lbs	
QC12-SDJCR-07JET	03280758	QC12	-	6,0 0.234	22 0.866	6,0 0.235	200,0 2900.8	93,0	0,0	0,0	0,3 0.660	DC..0702.. DC..21.5
QC12-SDJCL-07JET	03280759	QC12	-	6,0 0.234	22 0.866	6,0 0.235	200,0 2900.8	93,0	0,0	0,0	0,3 0.660	DC..0702.. DC..21.5
QC12-SDJCR-11JET	03280760	QC12	-	6,0 0.234	26 1.024	6,0 0.235	200,0 2900.8	93,0	0,0	0,0	0,3 0.660	DC..11T3.. DC..32.5
QC12-SDJCL-11JET	03280761	QC12	-	6,0 0.234	26 1.024	6,0 0.235	200,0 2900.8	93,0	0,0	0,0	0,3 0.660	DC..11T3.. DC..32.5
QC16-SDJCR-11JET	03280762	QC16	Duo	8,0 0.313	26 1.024	7,9 0.311	200,0 2900.8	93,0	0,0	0,0	0,3 0.660	DC..11T3.. DC..32.5
QC16-SDJCL-11JET	03280763	QC16	Duo	8,0 0.313	26 1.024	7,9 0.311	200,0 2900.8	93,0	0,0	0,0	0,3 0.660	DC..11T3.. DC..32.5

Spare Parts

For size	Insert key	Insert screw
..-07	 T07P-2	 C02506-T07P
..-11	 T15P-2	 C04008-T15P

Accessories

For size	Insert clamping torque	Mounting fixture	Torque key
..-07	 0.9NM	 SECO-MF7075-QC	 T00-07P09
..-11	 3.5NM	 SECO-MF7075-QC	 T00-15P35

QC-SVJBR/L-JET – ISO Turning, QC-heads for inserts VBGT and VBMT – Metric / Inch

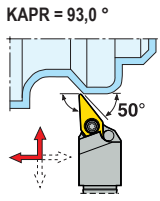

QC-SVJBR/L-JET





CTWS





- For inserts program, see page(s) 563, 564, 594, 602
- For more information on Jetstream Tooling® (High pressure coolant) and accessories, please see page(s) 38, 85-89, 1002
- GAMO° = Rake angle, LAMS° = Inclination angle
- CTMS = QC size
- CTWS = Insert shape and size
- For holder code key, see page(s) 11-12
- * Max coolant pressure
- Right-hand version shown
- Please check availability at www.secotools.com / Seco Online Store

Designation	Item number	CTMS	WF	LF	HF	CP*	KAPR°	GAMO°	LAMS°	Weight	CTWS
			mm Inch	mm Inch	mm Inch					bar psi	
QC12-SVJBR-11JET	03280764	QC12	6,0 0.234	26 1.024	6,0 0.235	200,0 2900.8	93,0	0,0	0,0	0,3 0.660	VB..1102.. VB..21.5.
QC12-SVJBL-11JET	03280765	QC12	6,0 0.234	26 1.024	6,0 0.235	200,0 2900.8	93,0	0,0	0,0	0,1 0.220	VB..1102.. VB..21.5.
QC16-SVJBR-11JET	03280766	QC16	8,0 0.313	26 1.024	7,9 0.311	200,0 2900.8	93,0	0,0	0,0	0,1 0.220	VB..1102.. VB..21.5.
QC16-SVJBL-11JET	03280767	QC16	8,0 0.313	26 1.024	7,9 0.311	200,0 2900.8	93,0	0,0	0,0	0,3 0.660	VB..1102.. VB..21.5.

Spare Parts

For size	Insert key	Insert screw
..-11	 T07P-2	 C02506-T07P

Accessories

For size	Insert clamping torque	Mounting fixture	Torque key
..-11	 0.9NM	 SECO-MF7075-QC	 T00-07P09

General ISO Turning Holders
Steadyline®
MDT
Mini-Shaft™
Grooving
Parting-off
X4
Adapters Clamping units
Accessories and Spare parts
Workpiece materials

QC-CFOR/L-JET – MDT, QC-heads for inserts LCMF – Metric/ Inch



QC-CFOR/L-JET

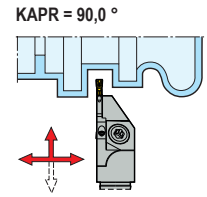
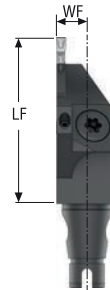
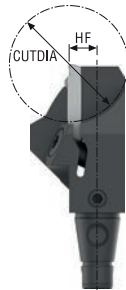

CTWS



- For inserts program, see page(s) 838
- For more information on Jetstream Tooling® (High pressure coolant) and accessories, please see page(s) 38, 85-89, 1002
- For holder code key, see page(s) 11-12
- * Max coolant pressure
- CTMS = QC size
- CTWS = Insert shape and size
- Right-hand version shown
- Please check availability at www.secotools.com / Seco Online Store

Designation	Item number	CTMS	WF	LF	HF	CUTDIA	CP*	KAPR°	Weight	CTWS
			mm Inch	mm Inch	mm Inch	mm Inch	bar psi		kg lbs	
QC12-CFOR-1902RBJET	03280768	QC12	6,0 0.236	32 1.260	6,0 0.235	25,4 1.000	200,0 2900.8	90,0	0,3 0.660	LC..1902..
QC12-CFOL-1902RBJET	03280769	QC12	6,0 0.236	32 1.260	6,0 0.235	25,4 1.000	200,0 2900.8	90,0	0,3 0.660	LC..1902..
QC16-CFOR-1902RBJET	03280770	QC16	8,0 0.315	32 1.260	7,9 0.311	25,4 1.000	200,0 2900.8	90,0	0,3 0.660	LC..1902..
QC16-CFOL-1902RBJET	03280771	QC16	8,0 0.315	32 1.260	7,9 0.311	25,4 1.000	200,0 2900.8	90,0	0,3 0.660	LC..1902..

Spare Parts

For size	Clamp key	Clamp screw
QC..-1902	 T15P-2	 L85012-T15P

Accessories

For size	Insert clamping torque	Mounting fixture	Torque key
QC..-1902	 5.0NM	 SECO-MF7075-QC	 T00-15P50

General ISO Turning Holders
Steadyline®
MDT
Mini-Shaft™
Grooving
Parting-off
X4
Adapters Clamping units
Accessories and Spare parts
Workpiece materials

QC...R/L150.10-...JETI – Parting-off, QC-heads for 150.10A-15 blades – Metric/ Inch

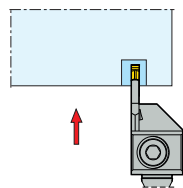

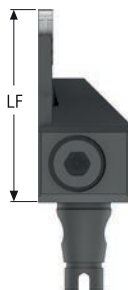
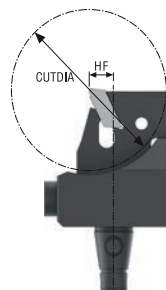

QC...R/L150.10-...JETI



- For inserts program, see page(s) 936, 937
- For more information on Jetstream Tooling® (High pressure coolant) and accessories, please see page(s) 38, 85-89, 1002
- For blades program, see page(s) 920
- For holder code key, see page(s) 11-12
- For CUTDIA, see blades page(s) 920
- CTMS = QC size
- * Max coolant pressure
- Right-hand version shown
- Please check availability at www.secotools.com / Seco Online Store

Designation	Item number	CTMS	LF	HF	CUTDIA	CP*	Weight	CTWS
			mm Inch	mm Inch	mm Inch	bar psi		
QC12-R150.10-15JETI	03280777	QC12	34,2 1.346	6,0 0.236	-	200,0 2900.8	0,1	Blade-15
QC12-L150.10-15JETI	03280776	QC12	34,2 1.346	6,0 0.236	-	200,0 2900.8	0,1	Blade-15
QC16-R150.10-15JETI	03280779	QC16	34,2 1.346	8,0 0.315	-	200,0 2900.8	0,1	Blade-15
QC16-L150.10-15JETI	03280778	QC16	34,2 1.346	8,0 0.315	-	200,0 2900.8	0,1	Blade-15

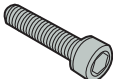
Spare Parts

For size	Clamp key	Clamp screw	O-ring
QC12/16	 4SMS795	 MC6S5X18	 ORING-4X1.5

Accessories

For size	Mounting fixture
QC12/16	 SECO-MF7075-QC

General ISO Turning
Holders

Steadyline®

MDT

Mini-Shaft™

Grooving

Parting-off

X4

Adapters
Clamping units

Accessories and
Spare parts

Workpiece
materials

QC.-PER/L-HDJET – Thread turning, QC-heads for S-inserts – Metric/ Inch



QC.-PER/L-HDJET

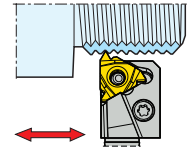
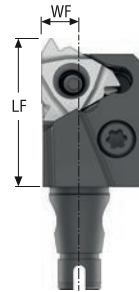

CTWS



- For inserts programme, see MN Threading catalogue
- For more information on Jetstream Tooling® (High pressure coolant) and accessories, please see page(s) 38, 85-89, 1002
- For holder code key, see page(s) 11-12
- * Max coolant pressure
- CTMS = QC size
- CTWS = Insert shape and size
- Right-hand version shown
- Please check availability at www.secotools.com / Seco Online Store

Designation	Item number	CTMS	WF	LF	HF	CP*	Weight	CTWS
			mm Inch	mm Inch	mm Inch		kg lbs	
QC12-PER-16HDJET	03280772	QC12	6,0 0.236	25 0.984	6,0 0.235	200,0 2900.8	0,3 0.660	16ER
QC12-PEL-16HDJET	03280773	QC12	6,0 0.236	25 0.984	6,0 0.235	200,0 2900.8	0,3 0.660	16EL
QC16-PER-16HDJET	03280774	QC16	8,0 0.315	25 0.984	7,9 0.311	200,0 2900.8	0,3 0.660	16ER
QC16-PEL-16HDJET	03280775	QC16	8,0 0.315	25 0.984	7,9 0.311	200,0 2900.8	0,3 0.660	16EL

Spare Parts

For size	Insert lever	Insert shim (S)	Lever key	Lever screw	Shim pin
QC12/16	PP3712	GXA16-1	T15P-2	LS0612-T15P	AC4625

Accessories

For size	Insert clamping torque	Insert shim (M)	Insert shim (S) 1	Insert shim (S) 2	Insert shim (S) 3	Insert shim (S) 4	Insert shim (S) 5	Insert shim (S) 6	Mounting fixture	Torque key
QC12/16	3.0NM	MXA16-1	GXA16-0	GXA16-2	GXA16-3	GXA16-4	GXA16-99	GXA16-98	SECO-MF7075-QC	T00-15P30

C.-DCLCR/L...JETI – Toolholders for inserts CCGT, CCGW, CCGX, CCMT and CCMW – Metric / Inch

C.-DCLCR/L...JETI
KAPR = 95,0°

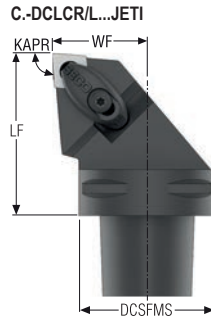
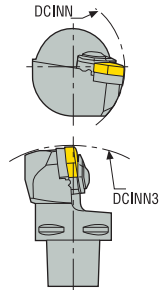
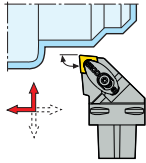

CTWS



- For inserts program, see page(s) 522, 523, 524, 525, 573, 574, 599
- For more information on Jetstream Tooling® (High pressure coolant) and accessories, please see page(s) 38, 85-89, 1002
- GAMO° = Rake angle, LAMS° = Inclination angle
- CTMS = Seco-Capto™ size
- CTWS = Insert shape and size
- For holder code key, see page(s) 11-12
- * Max coolant pressure
- ** Jetstream Tooling® Duo, see page(s) 38, 85-89
- For JETI coolant clamp it is recommended to set regular screw and double O-rings exchange rate to keep the safety first and minimize leakage for the application at hand
- Right-hand version shown
- Please check availability at www.secotools.com / Seco Online Store





Designation	Item number	CTMS	**	DCSFMS		WF	LF	DCINN	DCINN3	CP*	KAPR°	GAMO°	LAMS°	Weight	CTWS
				mm Inch	mm Inch										
C4-DCLCR-27050-09JETI	03282195	C4	Duo	40,0 1.575	27,0 1.063	50,0 1.969	-	-	-	70,0 1015.3	95,0	0,0	0,0	0,4 0.880	CC..09T3.. CC..32.5.
C4-DCLCL-27050-09JETI	03282193	C4	Duo	40,0 1.575	27,0 1.063	50,0 1.969	-	-	-	70,0 1015.3	95,0	0,0	0,0	0,4 0.880	CC..09T3.. CC..32.5.
C4-DCLCR-27050-12JETI	03282196	C4	Duo	40,0 1.575	27,0 1.063	50,0 1.969	-	-	-	70,0 1015.3	95,0	0,0	0,0	0,5 1.100	CC..1204.. CC..43.
C4-DCLCL-27050-12JETI	03282194	C4	Duo	40,0 1.575	27,0 1.063	50,0 1.969	-	-	-	70,0 1015.3	95,0	0,0	0,0	0,5 1.100	CC..1204.. CC..43.
C5-DCLCR-35060-12JETI	03282214	C5	Duo	50,0 1.969	35,0 1.378	60,0 2.362	-	-	-	70,0 1015.3	95,0	0,0	0,0	0,8 1.760	CC..1204.. CC..43.
C5-DCLCL-35060-12JETI	03282213	C5	Duo	50,0 1.969	35,0 1.378	60,0 2.362	-	-	-	70,0 1015.3	95,0	0,0	0,0	0,8 1.760	CC..1204.. CC..43.
C6-DCLCR-45065-12JETI	03282239	C6	Duo	63,0 2.480	45,0 1.772	65,0 2.559	-	-	-	70,0 1015.3	95,0	0,0	0,0	1,3 2.870	CC..1204.. CC..43.
C6-DCLCL-45065-12JETI	03282238	C6	Duo	63,0 2.480	45,0 1.772	65,0 2.559	-	-	-	70,0 1015.3	95,0	0,0	0,0	1,3 2.870	CC..1204.. CC..43.

Spare Parts

For size	Clamp key	Clamp screw	Coolant kit	Insert shim	Plug screw	Shim screw	Spring
-09	T09P-2	L84017-T09P	CP14U00S-2-SET	-	P6SS3X3G	-	S5808
-12	T15P-2	L85021-T15P	CP17U00S-2-SET	123.19-621	P6SS3X3G	CA5008	S7111

General ISO Turning Holders
Steadyline®
MDT
Mini-Shaft™
Grooving
Parting-off
X4
Adapters Clamping units
Accessories and Spare parts
Workpiece materials

Accessories

For size	Duo coolant plug screw	Insert clamping torque	Shim key	Torque key
-09	 P6SS3X5	 2.0NM	 -	 T00-09P20
-12	P6SS3X5	3.5NM	5SMS795	T00-15P35

C-DCLNR/L...JETI – Toolholders for inserts CNGA, CNGG, CNMA, CNMG and CNMM – Metric / Inch

C-DCLNR/L...JETI
KAPR = 95,0°

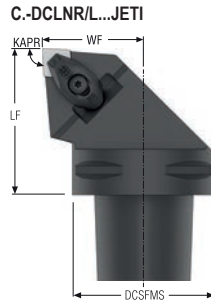
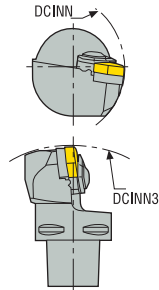
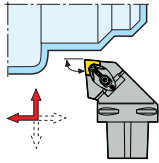







- For inserts program, see page(s) 527, 528, 529, 530, 531, 532, 533, 575, 576
- For more information on Jetstream Tooling® (High pressure coolant) and accessories, please see page(s) 38, 85-89, 1002
- GAMO° = Rake angle, LAMS° = Inclination angle
- CTMS = Seco-Capto™ size
- CTWS = Insert shape and size
- For holder code key, see page(s) 11-12
- * Max coolant pressure
- ** Jetstream Tooling® Duo, see page(s) 38, 85-89
- For JETI coolant clamp it is recommended to set regular screw and double O-rings exchange rate to keep the safety first and minimize leakage for the application at hand
- Right-hand version shown
- Please check availability at www.secotools.com / Seco Online Store



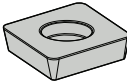

Designation	Item number	CTMS	**	DCSFMS		WF	LF	DCINN	DCINN3	CP*	KAPR°	GAMO°	LAMS°	Weight	CTWS						
				mm	Inch											mm	Inch	kg	lbs		
C4-DCLNR-27050-12JETI	03282178	C4	Duo	40,0	1.575	27,0	1.063	50,0	1.969	280,0	11.024	235,0	9.252	70,0	1015.3	95,0	-6,0	-6,0	0,4	0.880	CN..1204.. CN..43.
C4-DCLNL-27050-12JETI	03282177	C4	Duo	40,0	1.575	27,0	1.063	50,0	1.969	280,0	11.024	235,0	9.252	70,0	1015.3	95,0	-6,0	-6,0	0,4	0.880	CN..1204.. CN..43.
C5-DCLNR-35060-12JETI	03282202	C5	Duo	50,0	1.969	35,0	1.378	60,0	2.362	210,0	8.268	260,0	10.236	70,0	1015.3	95,0	-6,0	-6,0	0,8	1.760	CN..1204.. CN..43.
C5-DCLNL-35060-12JETI	03282201	C5	Duo	50,0	1.969	35,0	1.378	60,0	2.362	210,0	8.268	260,0	10.236	70,0	1015.3	95,0	-6,0	-6,0	0,8	1.760	CN..1204.. CN..43.
C5-DCLNR-35060-16JETI	03289606	C5	Duo	50,0	1.969	35,0	1.378	60,0	2.362	280,0	11.024	280,0	11.024	70,0	1015.3	95,0	-6,0	-6,0	0,8	1.760	CN..1606.. CN..54.
C5-DCLNL-35060-16JETI	03289605	C5	Duo	50,0	1.969	35,0	1.378	60,0	2.362	280,0	11.024	280,0	11.024	70,0	1015.3	95,0	-6,0	-6,0	0,8	1.760	CN..1606.. CN..54.
C6-DCLNR-45065-12JETI	03282223	C6	Duo	63,0	2.480	45,0	1.772	65,0	2.559	235,0	9.252	250,0	9.843	70,0	1015.3	95,0	-6,0	-6,0	1,3	2.870	CN..1204.. CN..43.
C6-DCLNL-45065-12JETI	03282221	C6	Duo	63,0	2.480	45,0	1.772	65,0	2.559	235,0	9.252	250,0	9.843	70,0	1015.3	95,0	-6,0	-6,0	1,4	3.090	CN..1204.. CN..43.
C6-DCLNR-45065-16JETI	03282224	C6	Duo	63,0	2.480	45,0	1.772	65,0	2.559	250,0	9.843	300,0	11.811	70,0	1015.3	95,0	-6,0	-6,0	1,3	2.870	CN..1606.. CN..54.
C6-DCLNL-45065-16JETI	03282222	C6	Duo	63,0	2.480	45,0	1.772	65,0	2.559	250,0	9.843	300,0	11.811	70,0	1015.3	95,0	-6,0	-6,0	1,3	2.870	CN..1606.. CN..54.
C8-DCLNR-55080-12JETI	03289623	C8	Duo	80,0	3.150	55,0	2.165	80,0	3.150	235,0	9.252	300,0	11.811	70,0	1015.3	95,0	-6,0	-6,0	2,6	5.730	CN..1204.. CN..43.
C8-DCLNL-55080-12JETI	03289621	C8	Duo	80,0	3.150	55,0	2.165	80,0	3.150	235,0	9.252	300,0	11.811	70,0	1015.3	95,0	-6,0	-6,0	2,6	5.730	CN..1204.. CN..43.
C8-DCLNR-55080-16JETI	03289624	C8	Duo	80,0	3.150	55,0	2.165	80,0	3.150	235,0	9.252	350,0	13.780	70,0	1015.3	95,0	-6,0	-6,0	2,6	5.730	CN..1606.. CN..54.
C8-DCLNL-55080-16JETI	03289622	C8	Duo	80,0	3.150	55,0	2.165	80,0	3.150	235,0	9.252	350,0	13.780	70,0	1015.3	95,0	-6,0	-6,0	2,6	5.730	CN..1606.. CN..54.

General ISO Turning Holders
Steadyline®
MDT
Mini-Shaft™
Grooving
Parting-off
X4
Adapters Clamping units
Accessories and Spare parts
Workpiece materials

Spare Parts

For size	Clamp key	Clamp screw	Coolant kit	Insert shim	Plug screw	Shim/clamp key	Shim screw	Spring
C4...R-12								
C4...L-12	-	L85021-T15P	CN17L00R-2-SET	DCO120310	P6SS3X3G	T15P-2	C04008-T15P	S7111
C5-12	-	L85021-T15P	CN17L00R-2-SET	DCO120310	P6SS3X3G	T15P-2	C04008-T15P	S7111
-16	T15P-2	L85021-T15P	CN21L00R-2-SET	DCN160616	P6SS3X3G	-	C05010-T20P	S7111
-12	-	L85021-T15P	CN17L00R-2-SET	DCO120310	P6SS3X3G	T15P-2	C04008-T15P	S7111

Accessories

For size	Duo coolant plug screw	Insert clamping torque	Shim key	Torque key
C4...R-12				
C4...L-12	P6SS3X5	3.5NM	-	T00-15P35
C5-12	P6SS3X5	3.5NM	-	T00-15P35
-16	P6SS3X5	3.5NM	T20P-2D	T00-15P35
-12	P6SS3X5	3.5NM	-	T00-15P35

General ISO Turning Holders

Steadyline®

MDT

Mini-Shaft™

Grooving

Parting-off

X4

Adapters Clamping units

Accessories and Spare parts

Workpiece materials

C.-DCRNR/L...JETI – Toolholders for inserts CNMA, CNMG and CNMM – Metric/ Inch

C.-DCRNR/L...JETI
KAPR = 75,0°

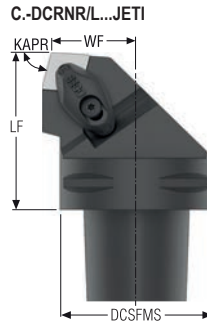
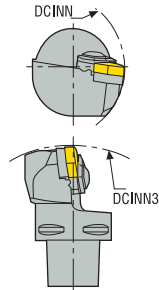
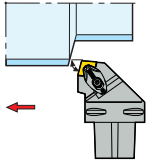







CTWS





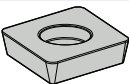

- For inserts program, see page(s) 527, 528, 529, 530, 531, 532, 533
- For more information on Jetstream Tooling® (High pressure coolant) and accessories, please see page(s) 38, 85-89, 1002
- GAMO° = Rake angle, LAMS° = Inclination angle
- CTMS = Seco-Capto™ size
- CTWS = Insert shape and size
- For holder code key, see page(s) 11-12
- * Max coolant pressure
- ** Jetstream Tooling® Duo, see page(s) 38, 85-89
- For JETI coolant clamp it is recommended to set regular screw and double O-rings exchange rate to keep the safety first and minimize leakage for the application at hand
- Right-hand version shown
- Please check availability at www.secotools.com / Seco Online Store

Designation	Item number	CTMS	**	DCSFMS	WF	LF	DCINN	DCINN3	CP*	KAPR°	GAMO°	LAMS°	Weight	CTWS
C6-DCRNR-35065-16JETI	03289615	C6	Duo	63,0 2.480	35,0 1.378	65,0 2.559	235,0 9.252	300,0 11.811	70,0 1015.3	75,0	-6,0	-6,0	1,3 2.870	CN..1606.. CN..54.
C6-DCRNL-35065-16JETI	03289614	C6	Duo	63,0 2.480	35,0 1.378	65,0 2.559	235,0 9.252	300,0 11.811	70,0 1015.3	75,0	-6,0	-6,0	1,3 2.870	CN..1606.. CN..54.

Spare Parts

For size	Clamp key	Clamp screw	Coolant kit	Insert shim	Plug screw	Shim screw	Spring
-16	 T15P-2	 L85021-T15P	 CN21L00R-2-SET	 DCN160616	 P6SS3X3G	 C05010-T20P	 S7111

Accessories

For size	Duo coolant plug screw	Insert clamping torque	Shim key	Torque key
-16	 P6SS3X5	 3.5NM	 T20P-2D	 T00-15P35

C-DDJCR/L...JETI – Toolholders for inserts DCGT, DCGW, DCMT, DCMW and DCMX – Metric/ Inch

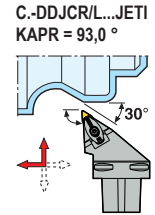
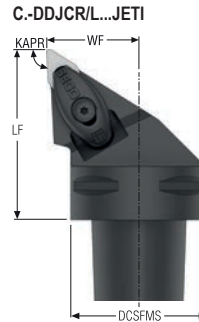
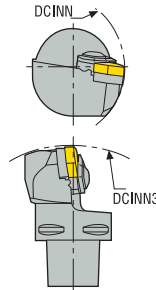

CTWS



- For inserts program, see page(s) 534, 535, 536, 578, 600
- For more information on Jetstream Tooling® (High pressure coolant) and accessories, please see page(s) 38, 85-89, 1002
- GAMO° = Rake angle, LAMS° = Inclination angle
- CTMS = Seco-Capto™ size
- CTWS = Insert shape and size
- For holder code key, see page(s) 11-12
- * Max coolant pressure
- ** Jetstream Tooling® Duo, see page(s) 38, 85-89
- For JETI coolant clamp it is recommended to set regular screw and double O-rings exchange rate to keep the safety first and minimize leakage for the application at hand
- Right-hand version shown
- Please check availability at www.secotools.com / Seco Online Store

Designation	Item number	CTMS	**	DCSFMS		LF	DCINN	DCINN3	CP*	KAPR°	GAMO°	LAMS°	Weight	CTWS
				mm Inch	mm Inch									
C4-DDJCR-27050-11JETI	03282198	C4	Duo	40,0 1.575	27,0 1.063	50,0 1.969	–	250,0 9.843	70,0 1015.3	93,0	0,0	0,0	0,4 0.880	DC..11T3.. DC..32.5.
C4-DDJCL-27050-11JETI	03282197	C4	Duo	40,0 1.575	27,0 1.063	50,0 1.969	–	250,0 9.843	70,0 1015.3	93,0	0,0	0,0	0,4 0.880	DC..11T3.. DC..32.5.
C5-DDJCR-35060-11JETI	03282216	C5	Duo	50,0 1.969	35,0 1.378	60,0 2.362	–	250,0 9.843	70,0 1015.3	93,0	0,0	0,0	0,7 1.540	DC..11T3.. DC..32.5.
C5-DDJCL-35060-11JETI	03282215	C5	Duo	50,0 1.969	35,0 1.378	60,0 2.362	–	250,0 9.843	70,0 1015.3	93,0	0,0	0,0	0,7 1.540	DC..11T3.. DC..32.5.
C6-DDJCR-45065-11JETI	03282241	C6	Duo	63,0 2.480	45,0 1.772	65,0 2.559	–	300,0 11.811	70,0 1015.3	93,0	0,0	0,0	1,1 2.430	DC..11T3.. DC..32.5.
C6-DDJCL-45065-11JETI	03282240	C6	Duo	63,0 2.480	45,0 1.772	65,0 2.559	–	300,0 11.811	70,0 1015.3	93,0	0,0	0,0	1,1 2.430	DC..11T3.. DC..32.5.

Spare Parts

For size	Clamp key	Clamp screw	Coolant kit	Insert shim	Plug screw	Shim screw	Spring
-11	T09P-2	L84017-T09P	CP14U00S-2-SET	126.19-620	P6SS3X3G	C94006-T15P	S5808

Accessories

For size	Duo coolant plug screw	Insert clamping torque	Shim key	Torque key
-11	P6SS3X5	2.0NM	T15P-2	T00-09P20

C.-DDJNR/L...JETI – Toolholders for inserts DNGA, DNGG, DNGM, DNMA, DNMG, DNMM, DNMU and DNMX – Metric / Inch

C.-DDJNR/L...JETI
KAPR = 93,0°

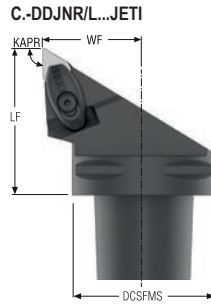
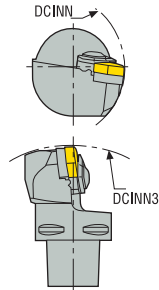
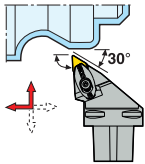







- For inserts program, see page(s) 537, 538, 539, 540, 541, 579, 580, 598
- For more information on Jetstream Tooling® (High pressure coolant) and accessories, please see page(s) 38, 85-89, 1002
- GAMO° = Rake angle, LAMS° = Inclination angle
- CTMS = Seco-Capto™ size
- CTWS = Insert shape and size
- For holder code key, see page(s) 11-12
- * Max coolant pressure
- ** Jetstream Tooling® Duo, see page(s) 38, 85-89
- For JETI coolant clamp it is recommended to set regular screw and double O-rings exchange rate to keep the safety first and minimize leakage for the application at hand
- Right-hand version shown
- * Use the right shim & the right screw for the selected insert. For details, see page 99
- Please check availability at www.secotools.com / Seco Online Store



Designation	Item number	CTMS	**	DCSFMS	WF	LF	DCINN	DCINN3	CP*	KAPR°	GAMO°	LAMS°	Weight	CTWS
				mm Inch	mm Inch	mm Inch	mm Inch	mm Inch	bar psi				kg lbs	
C4-DDJNR-27050-11JETI	03289599	C4	Duo	40,0 1.575	27,0 1.063	50,0 1.969	250,0 9.843	195,0 7.677	70,0 1015.3	93,0	-6,0	-6,0	0,4 0.880	DN..1104.. DN..33.
C4-DDJNL-27050-11JETI	03289598	C4	Duo	40,0 1.575	27,0 1.063	50,0 1.969	250,0 9.843	195,0 7.677	70,0 1015.3	93,0	-6,0	-6,0	0,4 0.880	DN..1104.. DN..33.
C4-DDJNR-27055-15-04JETI	03282181	C4	Duo	40,0 1.575	27,0 1.063	55,0 2.165	235,0 9.252	195,0 7.677	70,0 1015.3	93,0	-6,0	-6,0	0,4 0.880	DN.1504/DN..1506 DN..43/DN..44*
C4-DDJNL-27055-15-04JETI	03282179	C4	Duo	40,0 1.575	27,0 1.063	55,0 2.165	235,0 9.252	195,0 7.677	70,0 1015.3	93,0	-6,0	-6,0	0,4 0.880	DN.1504/DN..1506 DN..43/DN..44*
C4-DDJNR-27055-15JETI	03282182	C4	Duo	40,0 1.575	27,0 1.063	55,0 2.165	235,0 9.252	195,0 7.677	70,0 1015.3	93,0	-6,0	-6,0	0,4 0.880	DN.1504/DN..1506 DN..43/DN..44*
C4-DDJNL-27055-15JETI	03282180	C4	Duo	40,0 1.575	27,0 1.063	55,0 2.165	235,0 9.252	195,0 7.677	70,0 1015.3	93,0	-6,0	-6,0	0,4 0.880	DN.1504/DN..1506 DN..43/DN..44*
C5-DDJNR-35060-11JETI	03289608	C5	Duo	50,0 1.969	35,0 1.378	60,0 2.362	250,0 9.843	195,0 7.677	70,0 1015.3	93,0	-6,0	-6,0	0,7 1.540	DN..1104.. DN..33.
C5-DDJNL-35060-11JETI	03289607	C5	Duo	50,0 1.969	35,0 1.378	60,0 2.362	250,0 9.843	195,0 7.677	70,0 1015.3	93,0	-6,0	-6,0	0,7 1.540	DN..1104.. DN..33.
C5-DDJNR-35060-15-04JETI	03282205	C5	Duo	50,0 1.969	35,0 1.378	60,0 2.362	235,0 9.252	195,0 7.677	70,0 1015.3	93,0	-6,0	-6,0	0,7 1.540	DN.1504/DN..1506 DN..43/DN..44*
C5-DDJNL-35060-15-04JETI	03282203	C5	Duo	50,0 1.969	35,0 1.378	60,0 2.362	235,0 9.252	195,0 7.677	70,0 1015.3	93,0	-6,0	-6,0	0,7 1.540	DN.1504/DN..1506 DN..43/DN..44*
C5-DDJNR-35060-15JETI	03282206	C5	Duo	50,0 1.969	35,0 1.378	60,0 2.362	235,0 9.252	195,0 7.677	70,0 1015.3	93,0	-6,0	-6,0	1,2 2.650	DN.1504/DN..1506 DN..43/DN..44*
C5-DDJNL-35060-15JETI	03282204	C5	Duo	50,0 1.969	35,0 1.378	60,0 2.362	235,0 9.252	195,0 7.677	70,0 1015.3	93,0	-6,0	-6,0	0,9 1.980	DN.1504/DN..1506 DN..43/DN..44*
C6-DDJNR-45065-15-04JETI	03282227	C6	Duo	63,0 2.480	45,0 1.772	65,0 2.559	275,0 10.827	250,0 9.843	70,0 1015.3	93,0	-6,0	-6,0	1,1 2.430	DN.1504/DN..1506 DN..43/DN..44*
C6-DDJNL-45065-15-04JETI	03282225	C6	Duo	63,0 2.480	45,0 1.772	65,0 2.559	275,0 10.827	250,0 9.843	70,0 1015.3	93,0	-6,0	-6,0	1,1 2.430	DN.1504/DN..1506 DN..43/DN..44*
C6-DDJNR-45065-15JETI	03282228	C6	Duo	63,0 2.480	45,0 1.772	65,0 2.559	275,0 10.827	250,0 9.843	70,0 1015.3	93,0	-6,0	-6,0	1,1 2.430	DN.1504/DN..1506 DN..43/DN..44*
C6-DDJNL-45065-15JETI	03282226	C6	Duo	63,0 2.480	45,0 1.772	65,0 2.559	275,0 10.827	250,0 9.843	70,0 1015.3	93,0	-6,0	-6,0	1,1 2.430	DN.1504/DN..1506 DN..43/DN..44*
C8-DDJNR-55080-15JETI	03289626	C8	Duo	80,0 3.150	55,0 2.165	80,0 3.150	320,0 12.598	300,0 11.811	70,0 1015.3	93,0	-6,0	-6,0	2,3 5.070	DN.1504/DN..1506 DN..43/DN..44*
C8-DDJNL-55080-15JETI	03289625	C8	Duo	80,0 3.150	55,0 2.165	80,0 3.150	320,0 12.598	300,0 11.811	70,0 1015.3	93,0	-6,0	-6,0	2,3 5.070	DN.1504/DN..1506 DN..43/DN..44*

General ISO Turning Holders
Steadyline®
MDT
Mini-Shaft™
Grooving
Parting-off
X4
Adapters Clamping units
Accessories and Spare parts
Workpiece materials

Spare Parts

For size	Clamp screw	Coolant kit	Insert shim	Plug screw	Shim/clamp key	Shim screw	Spring
R...11	 L84017-T09P	 CX14U10S-2R-SET	 DDN110310	 P6SS3X3G	 T09P-2	 C03007-T09P	 S5808
L...11	L84017-T09P	CX14U10S-2L-SET	DDN110310	P6SS3X3G	T09P-2	C03007-T09P	S5808
R...15-04	L85021-T15P	CN17U10S-2R-SET	DDN150616	P6SS3X3G	T15P-2	C04011-T15P	S7111
L...15-04	L85021-T15P	CN17U10S-2L-SET	DDN150616	P6SS3X3G	T15P-2	C04011-T15P	S7111
R...15	L85021-T15P	CN17U10S-2R-SET	DDN150416	P6SS3X3G	T15P-2	C04008-T15P	S7111
L...15	L85021-T15P	CN17U10S-2L-SET	DDN150416	P6SS3X3G	T15P-2	C04008-T15P	S7111
C5-R...15-04	L85021-T15P	CN17U10S-2R-SET	DDN150616	P6SS3X3G	T15P-2	C04008-T15P	S7111
C5-L...15-04	L85021-T15P	CN17U10S-2L-SET	DDN150616	P6SS3X3G	T15P-2	C04008-T15P	S7111

Accessories

For size	Duo coolant plug screw	Insert clamping torque	Torque key
R...11	 P6SS3X5	 2.0NM	 T00-09P20
L...11	P6SS3X5	2.0NM	T00-09P20
R...15-04	P6SS3X5	3.5NM	T00-15P35
L...15-04	P6SS3X5	3.5NM	T00-15P35
R...15	P6SS3X5	3.5NM	T00-15P35
L...15	P6SS3X5	3.5NM	T00-15P35
C5-R...15-04	P6SS3X5	3.5NM	T00-15P35
C5-L...15-04	P6SS3X5	3.5NM	T00-15P35

General ISO Turning Holders

Steadyline®

MDT

Mini-Shaft™

Grooving

Parting-off

X4

Adapters Clamping units

Accessories and Spare parts

Workpiece materials

C.-DDUNR/L...JETI – Toolholders for inserts DNGA, DNGM, DNMA, DNMG, DNMM and DNMX – Metric / Inch

C.-DDUNR/L...JETI
KAPR = 93,0°

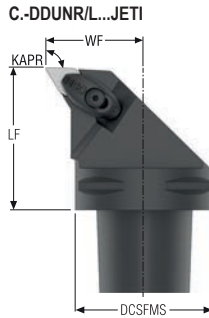
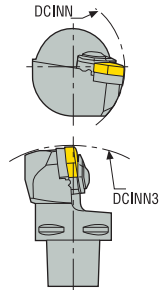
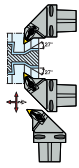

- For inserts program, see page(s) 537, 538, 539, 540, 541, 579, 580, 598
- For more information on Jetstream Tooling® (High pressure coolant) and accessories, please see page(s) 38, 85-89, 1002
- GAMO° = Rake angle, LAMS° = Inclination angle
- CTMS = Seco-Capto™ size
- CTWS = Insert shape and size
- For holder code key, see page(s) 11-12
- * Max coolant pressure
- ** Jetstream Tooling® Duo, see page(s) 38, 85-89
- For JETI coolant clamp it is recommended to set regular screw and double O-rings exchange rate to keep the safety first and minimize leakage for the application at hand
- Right-hand version shown
- * Use the right shim & the right screw for the selected insert. For details, see page 99
- Please check availability at www.secotools.com / Seco Online Store

Designation	Item number	CTMS	**	DCSFMS		WF	LF	DCINN	DCINN3	CP*	KAPR°	GAMO°	LAMS°	Weight	CTWS						
				mm	Inch																
C6-DDUNR-45065-15JETI	03289617	C6	Duo	63,0	2.480	45,0	1.772	65,0	2.559	235,0	9.252	300,0	11.811	70,0	1015.3	93,0	-6,0	-7,0	1,3	2.870	DN.1504/DN..1506 DN..43/DN..44*
C6-DDUNL-45065-15JETI	03289616	C6	Duo	63,0	2.480	45,0	1.772	65,0	2.559	235,0	9.252	300,0	11.811	70,0	1015.3	93,0	-6,0	-7,0	1,3	2.870	DN.1504/DN..1506 DN..43/DN..44*
C8-DDUNR-55080-15JETI	03289628	C8	Duo	80,0	3.150	55,0	2.165	80,0	3.150	220,0	8.661	350,0	13.780	70,0	1015.3	93,0	-6,0	-7,0	2,5	5.510	DN.1504/DN..1506 DN..43/DN..44*
C8-DDUNL-55080-15JETI	03289627	C8	Duo	80,0	3.150	55,0	2.165	80,0	3.150	220,0	8.661	350,0	13.780	70,0	1015.3	93,0	-6,0	-7,0	2,5	5.510	DN.1504/DN..1506 DN..43/DN..44*

Spare Parts

For size	Clamp screw	Coolant kit	Insert shim	Plug screw	Shim/clamp key	Shim screw	Spring
-15	L85021-T15P	CN17U00S-2-SET	DDN150416	P6SS3X3G	T15P-2	C04008-T15P	S7111

Accessories

For size	Duo coolant plug screw	Insert clamping torque	Torque key
-15	P6SS3X5	3.5NM	T00-15P35

General ISO Turning
Holders

Steadyline®

MDT

Mini-Shaft™

Grooving

Parting-off

X4

Adapters
Clamping units

Accessories and
Spare parts

Workpiece
materials

C.-DSSNR/L...JETI – Toolholders for inserts SNGA, SNMA, SNMG and SNMM – Metric/ Inch

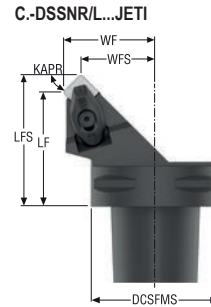
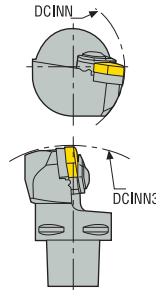

C.-DSSNR/L...JETI
KAPR = 45,0 °

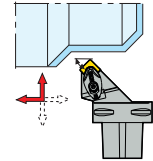

CTWS







- For inserts program, see page(s) 550, 551, 552, 553, 585
- For more information on Jetstream Tooling® (High pressure coolant) and accessories, please see page(s) 38, 85-89, 1002
- GAMO° = Rake angle, LAMS° = Inclination angle
- CTMS = Seco-Capto™ size
- CTWS = Insert shape and size
- For holder code key, see page(s) 11-12
- * Max coolant pressure
- ** Jetstream Tooling® Duo, see page(s) 38, 85-89
- For JETI coolant clamp it is recommended to set regular screw and double O-rings exchange rate to keep the safety first and minimize leakage for the application at hand
- Right-hand version shown
- Please check availability at www.secotools.com / Seco Online Store

Designation	Item number	CTMS	**	DCSFMS		WF	LF	DCINN	DCINN3	CP*	KAPR°	GAMO°	LAMS°	Weight	CTWS						
				mm	Inch	mm	mm	mm	mm	mm	mm	bar	psi			kg	lbs				
C4-DSSNR-27048-12JETI	03282184	C4	Duo	40,0	1.575	27,0	1.063	48,0	1.890	165,0	6.496	250,0	9.843	70,0	1015.3	45,0	-8,0	0,0	0,5	1.100	SN..1204.. SN..43.
C4-DSSNL-27048-12JETI	03282183	C4	Duo	40,0	1.575	27,0	1.063	48,0	1.890	165,0	6.496	250,0	9.843	70,0	1015.3	45,0	-8,0	0,0	0,5	1.100	SN..1204.. SN..43.
C5-DSSNR-35052-12JETI	03282208	C5	Duo	50,0	1.969	35,0	1.378	52,0	2.047	220,0	8.661	220,0	8.661	70,0	1015.3	45,0	-8,0	0,0	0,6	1.320	SN..1204.. SN..43.
C5-DSSNL-35052-12JETI	03282207	C5	Duo	50,0	1.969	35,0	1.378	52,0	2.047	220,0	8.661	220,0	8.661	70,0	1015.3	45,0	-8,0	0,0	0,8	1.760	SN..1204.. SN..43.
C6-DSSNR-45056-12JETI	03284734	C6	Duo	63,0	2.480	45,0	1.772	56,0	2.205	220,0	8.661	250,0	9.843	70,0	1015.3	45,0	-8,0	0,0	1,1	2.430	SN..1204.. SN..43.
C6-DSSNL-45056-12JETI	03282229	C6	Duo	63,0	2.480	45,0	1.772	56,0	2.205	220,0	8.661	250,0	9.843	70,0	1015.3	45,0	-8,0	0,0	1,1	2.430	SN..1204.. SN..43.
C6-DSSNR-45056-15JETI	03282231	C6	Duo	63,0	2.480	45,0	1.772	56,0	2.205	220,0	8.661	300,0	11.811	70,0	1015.3	45,0	-8,0	0,0	1,2	2.650	SN..1506.. SN..54.
C6-DSSNL-45056-15JETI	03282230	C6	Duo	63,0	2.480	45,0	1.772	56,0	2.205	220,0	8.661	300,0	11.811	70,0	1015.3	45,0	-8,0	0,0	1,2	2.650	SN..1506.. SN..54.
C8-DSSNR-55080-12JETI	03289630	C8	Duo	80,0	3.150	55,0	2.165	80,0	3.150	250,0	9.843	250,0	9.843	70,0	1015.3	45,0	-8,0	0,0	2,4	5.290	SN..1204.. SN..43.
C8-DSSNL-55080-12JETI	03289629	C8	Duo	80,0	3.150	55,0	2.165	80,0	3.150	250,0	9.843	250,0	9.843	70,0	1015.3	45,0	-8,0	0,0	2,4	5.290	SN..1204.. SN..43.

Spare Parts

For size	Clamp key	Clamp screw	Coolant kit	Insert shim	Plug screw	Shim/clamp key	Shim screw	Spring
-12	-	L85021-T15P	CN17L00R-2-SET	DSN120616	P6SS3X3G	T15P-2	C04008-T15P	S7111
-15	T15P-2	L85021-T15P	CN21L00R-2-SET	DSN150624	P6SS3X3G	-	C05010-T20P	S7111

Accessories

For size	Duo coolant plug screw	Insert clamping torque	Shim key	Torque key
-12	 P6SS3X5	 3.5NM	 -	 T00-15P35
-15	P6SS3X5	3.5NM	T20P-2D	T00-15P35

General ISO Turning
Holders

Steadyline®

MDT

Mini-Shaft™

Grooving

Parting-off

X4

Adapters
Clamping units

Accessories and
Spare parts

Workpiece
materials

C-DTJNR/L...JETI – Toolholders for inserts TNGA, TNMA, TNMG, TNMM and TNMX – Metric/ Inch

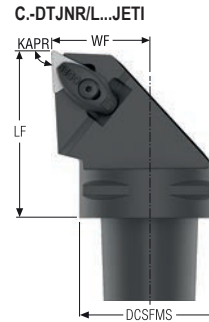
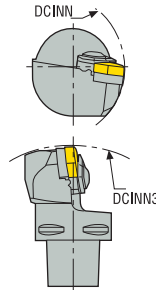

C-DTJNR/L...JETI
KAPR = 93,0 °

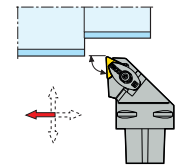

CTWS



- For inserts program, see page(s) 558, 559, 560, 561, 590, 593
- For more information on Jetstream Tooling® (High pressure coolant) and accessories, please see page(s) 38, 85-89, 1002
- GAMO° = Rake angle, LAMS° = Inclination angle
- CTMS = Seco-Capto™ size
- CTWS = Insert shape and size
- For holder code key, see page(s) 11-12
- * Max coolant pressure
- ** Jetstream Tooling® Duo, see page(s) 38, 85-89
- For JETI coolant clamp it is recommended to set regular screw and double O-rings exchange rate to keep the safety first and minimize leakage for the application at hand
- Right-hand version shown
- Please check availability at www.secotools.com / Seco Online Store

Designation	Item number	CTMS	**	DCSFMS		LF	DCINN	DCINN3	CP*	KAPR°	GAMO°	LAMS°	Weight	CTWS
				mm Inch	mm Inch									
C4-DTJNR-27050-16JETI	03282186	C4	Duo	40,0 1.575	27,0 1.063	50,0 1.969	230,0 9.055	230,0 9.055	70,0 1015.3	93,0	-6,0	-6,0	0,5 1.100	TN..1604.. TN..33.
C4-DTJNL-27050-16JETI	03282185	C4	Duo	40,0 1.575	27,0 1.063	50,0 1.969	230,0 9.055	230,0 9.055	70,0 1015.3	93,0	-6,0	-6,0	0,5 1.100	TN..1604.. TN..33.
C5-DTJNR-35060-16JETI	03289610	C5	Duo	50,0 1.969	35,0 1.378	60,0 2.362	220,0 8.661	250,0 9.843	70,0 1015.3	93,0	-6,0	-6,0	0,8 1.760	TN..1604.. TN..33.
C5-DTJNL-35060-16JETI	03289609	C5	Duo	50,0 1.969	35,0 1.378	60,0 2.362	220,0 8.661	250,0 9.843	70,0 1015.3	93,0	-6,0	-6,0	0,8 1.760	TN..1604.. TN..33.
C6-DTJNR-45065-16JETI	03282233	C6	Duo	63,0 2.480	45,0 1.772	65,0 2.559	250,0 9.843	250,0 9.843	70,0 1015.3	93,0	-6,0	-6,0	1,3 2.870	TN..1604.. TN..33.
C6-DTJNL-45065-16JETI	03282232	C6	Duo	63,0 2.480	45,0 1.772	65,0 2.559	250,0 9.843	250,0 9.843	70,0 1015.3	93,0	-6,0	-6,0	1,3 2.870	TN..1604.. TN..33.

Spare Parts

For size	Clamp screw	Coolant kit	Insert shim	Plug screw	Shim/clamp key	Shim screw	Spring
R.-16	L84017-T09P	CN14U10S-2L-SET	DTN160616	P6SS3X3G	T09P-2	C03007-T09P	S5808
L.-16	L84017-T09P	CN14U10S-2R-SET	DTN160616	P6SS3X3G	T09P-2	C03007-T09P	S5808

Accessories

For size	Duo coolant plug screw	Insert clamping torque	Torque key
R.-16	P6SS3X5	2.0NM	T00-09P20
L.-16	P6SS3X5	2.0NM	T00-09P20

C.-DVHBR/L...JETI – Toolholders for inserts VBMT, VBGT, VBGW, VBMW and VCGT – Metric / Inch

C.-DVHBR/L...JETI
KAPR = 107,5 °

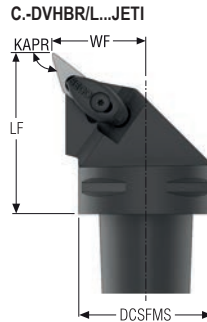
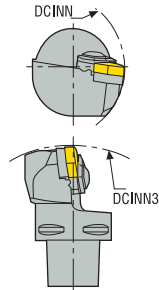
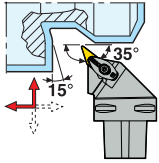

CTWS



- For inserts program, see page(s) 563, 564, 594, 602
- For more information on Jetstream Tooling® (High pressure coolant) and accessories, please see page(s) 38, 85-89, 1002
- GAMO° = Rake angle, LAMS° = Inclination angle
- CTMS = Seco-Capto™ size
- CTWS = Insert shape and size
- For holder code key, see page(s) 11-12
- * Max coolant pressure
- ** Jetstream Tooling® Duo, see page(s) 38, 85-89
- For JETI coolant clamp it is recommended to set regular screw and double O-rings exchange rate to keep the safety first and minimize leakage for the application at hand
- Right-hand version shown
- Please check availability at www.secotools.com / Seco Online Store

Designation	Item number	CTMS	**	DCSFMS	WF	LF	DCINN	DCINN3	CP*	KAPR°	GAMO°	LAMS°	Weight	CTWS
				mm Inch	mm Inch	mm Inch	mm Inch	mm Inch	bar psi	kg lbs				
C4-DVHBR-27050-16JETI	03289601	C4	Duo	40,0 1.575	27,0 1.063	50,0 1.969	–	300,0 11.811	70,0 1015.3	107,5	0,0	0,0	0,4 0.880	VB../VC..1604 VB../VC..33.
C4-DVHBL-27050-16JETI	03289600	C4	Duo	40,0 1.575	27,0 1.063	50,0 1.969	–	300,0 11.811	70,0 1015.3	107,5	0,0	0,0	0,4 0.880	VB../VC..1604 VB../VC..33.
C5-DVHBR-35060-16JETI	03289612	C5	Duo	50,0 1.969	35,0 1.378	60,0 2.362	–	300,0 11.811	70,0 1015.3	107,5	0,0	0,0	0,7 1.540	VB../VC..1604 VB../VC..33.
C5-DVHBL-35060-16JETI	03289611	C5	Duo	50,0 1.969	35,0 1.378	60,0 2.362	–	300,0 11.811	70,0 1015.3	107,5	0,0	0,0	0,7 1.540	VB../VC..1604 VB../VC..33.
C6-DVHBR-45065-16JETI	03289619	C6	Duo	63,0 2.480	45,0 1.772	65,0 2.559	–	300,0 11.811	70,0 1015.3	107,5	0,0	0,0	1,2 2.650	VB../VC..1604 VB../VC..33.
C6-DVHBL-45065-16JETI	03289618	C6	Duo	63,0 2.480	45,0 1.772	65,0 2.559	–	300,0 11.811	70,0 1015.3	107,5	0,0	0,0	1,2 2.650	VB../VC..1604 VB../VC..33.

Spare Parts

For size	Clamp key	Clamp screw	Coolant kit	Insert shim	Plug screw	Shim screw	Spring
R.-16	T09P-2	L84017-T09P	CP14U20S-2L-SET	171.19-620	P6SS3X3G	C94006-T15P	S5808
L.-16	T09P-2	L84017-T09P	CP14U20S-2R-SET	171.19-620	P6SS3X3G	C94006-T15P	S5808

Accessories

For size	Duo coolant plug screw	Insert clamping torque	Shim key	Torque key
R.-16	P6SS3X5	2.0NM	T15P-2	T00-09P20
L.-16	P6SS3X5	2.0NM	T15P-2	T00-09P20

C.-DVJBR/L...JETI – Toolholders for inserts VBMT, VBGT, VBGW, VBMW and VCGT – Metric/ Inch

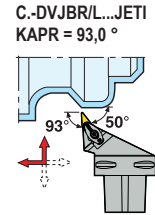
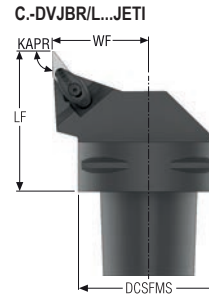
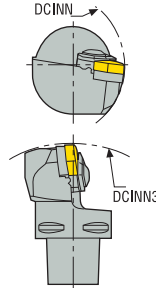

CTWS







- For inserts program, see page(s) 563, 564, 564, 564, 594, 602
- For more information on Jetstream Tooling® (High pressure coolant) and accessories, please see page(s) 38, 85-89, 1002
- GAMO° = Rake angle, LAMS° = Inclination angle
- CTMS = Seco-Capto™ size
- CTWS = Insert shape and size
- For holder code key, see page(s) 11-12
- * Max coolant pressure
- ** Jetstream Tooling® Duo, see page(s) 38, 85-89
- For JETI coolant clamp it is recommended to set regular screw and double O-rings exchange rate to keep the safety first and minimize leakage for the application at hand
- Right-hand version shown
- Please check availability at www.secotools.com / Seco Online Store

Designation	Item number	CTMS	**	DCSFMS		LF	DCINN	DCINN3	CP*	KAPR°	GAMO°	LAMS°	Weight	CTWS
				mm Inch	mm Inch									
C4-DVJBR-27055-16JETI	03282200	C4	Duo	40,0 1.575	27,0 1.063	55,0 2.165	-	200,0 7.874	70,0 1015.3	93,0	0,0	0,0	0,4 0.880	VB..VC..1604 VB..VC..33.
C4-DVJBL-27055-16JETI	03282199	C4	Duo	40,0 1.575	27,0 1.063	55,0 2.165	-	200,0 7.874	70,0 1015.3	93,0	0,0	0,0	0,4 0.880	VB..VC..1604 VB..VC..33.
C5-DVJBR-35060-16JETI	03282220	C5	Duo	50,0 1.969	35,0 1.378	60,0 2.362	-	200,0 7.874	70,0 1015.3	93,0	0,0	0,0	0,7 1.540	VB..VC..1604 VB..VC..33.
C5-DVJBL-35060-16JETI	03282219	C5	Duo	50,0 1.969	35,0 1.378	60,0 2.362	-	200,0 7.874	70,0 1015.3	93,0	0,0	0,0	0,7 1.540	VB..VC..1604 VB..VC..33.
C6-DVJBR-45065-16JETI	03282245	C6	Duo	63,0 2.480	45,0 1.772	65,0 2.559	-	200,0 7.874	70,0 1015.3	93,0	0,0	0,0	1,1 2.430	VB..VC..1604 VB..VC..33.
C6-DVJBL-45065-16JETI	03282244	C6	Duo	63,0 2.480	45,0 1.772	65,0 2.559	-	200,0 7.874	70,0 1015.3	93,0	0,0	0,0	1,1 2.430	VB..VC..1604 VB..VC..33.
C8-DVJBR-55080-16JETI	03289632	C8	Duo	80,0 3.150	55,0 2.165	80,0 3.150	-	250,0 9.843	70,0 1015.3	93,0	0,0	0,0	2,5 5.510	VB..VC..1604 VB..VC..33.
C8-DVJBL-55080-16JETI	03289631	C8	Duo	80,0 3.150	55,0 2.165	80,0 3.150	-	250,0 9.843	70,0 1015.3	93,0	0,0	0,0	2,5 5.510	VB..VC..1604 VB..VC..33.

Spare Parts

For size	Clamp key	Clamp screw	Coolant kit	Insert shim	Plug screw	Shim screw	Spring
R.-16	T09P-2	L84017-T09P	CP14U20S-2L-SET	171.19-620	P6SS3X3G	C94006-T15P	S5808
L.-16	T09P-2	L84017-T09P	CP14U20S-2R-SET	171.19-620	P6SS3X3G	C94006-T15P	S5808

Accessories

For size	Duo coolant plug screw	Insert clamping torque	Shim key	Torque key
R.-16	 P6SS3X5	 2.0NM	 T15P-2	 T00-09P20
L.-16	P6SS3X5	2.0NM	T15P-2	T00-09P20

General ISO Turning
Holders

Steadyline®

MDT

Mini-Shaft™

Grooving

Parting-off

X4

Adapters
Clamping units

Accessories and
Spare parts

Workpiece
materials

C.-DVJNR/L...JETI – Toolholders for inserts VNGA, VNGG, VNGM, VNMA and VNMG – Metric/ Inch

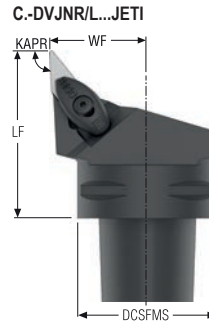
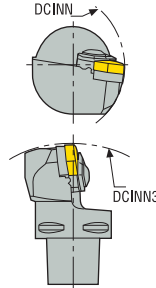

C.-DVJNR/L...JETI
KAPR = 93,0 °

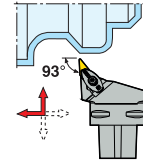

CTWS







- For inserts program, see page(s) 565, 566, 595
- For more information on Jetstream Tooling® (High pressure coolant) and accessories, please see page(s) 38, 85-89, 1002
- GAMO° = Rake angle, LAMS° = Inclination angle
- CTMS = Seco-Capto™ size
- CTWS = Insert shape and size
- For holder code key, see page(s) 11-12
- * Max coolant pressure
- ** Jetstream Tooling® Duo, see page(s) 38, 85-89
- For JETI coolant clamp it is recommended to set regular screw and double O-rings exchange rate to keep the safety first and minimize leakage for the application at hand
- Right-hand version shown
- Please check availability at www.secotools.com / Seco Online Store

Designation	Item number	CTMS	**	DCSFMS		LF	DCINN	DCINN3	CP*	KAPR°	GAMO°	LAMS°	Weight	CTWS							
				mm	Inch																
C4-DVJNR-27060-16JETI	03282188	C4	Duo	40,0	1.575	27,0	1.063	60,0	2.362	260,0	10.236	100,0	3.937	70,0	1015.3	93,0	-4,5	-13,5	0,5	VN..1604..	VN..33.
C4-DVJNL-27060-16JETI	03282187	C4	Duo	40,0	1.575	27,0	1.063	60,0	2.362	260,0	10.236	100,0	3.937	70,0	1015.3	93,0	-4,5	-13,5	0,5	VN..1604..	VN..33.
C5-DVJNR-35060-16JETI	03282210	C5	Duo	50,0	1.969	35,0	1.378	60,0	2.362	280,0	11.024	100,0	3.937	70,0	1015.3	93,0	-4,5	-13,5	0,7	VN..1604..	VN..33.
C5-DVJNL-35060-16JETI	03282209	C5	Duo	50,0	1.969	35,0	1.378	60,0	2.362	280,0	11.024	100,0	3.937	70,0	1015.3	93,0	-4,5	-13,5	0,5	VN..1604..	VN..33.
C6-DVJNR-45065-16JETI	03282235	C6	Duo	63,0	2.480	45,0	1.772	65,0	2.559	300,0	11.811	110,0	4.331	70,0	1015.3	93,0	-4,5	-13,5	1,2	VN..1604..	VN..33.
C6-DVJNL-45065-16JETI	03282234	C6	Duo	63,0	2.480	45,0	1.772	65,0	2.559	300,0	11.811	110,0	4.331	70,0	1015.3	93,0	-4,5	-13,5	1,2	VN..1604..	VN..33.

Spare Parts

For size	Clamp key	Clamp screw	Coolant kit	Insert shim	Plug screw	Shim screw	Spring
C4/ C5-..R-16	T09P-2	L84017-T09P	CN14U20S-2L-SET	171.19-620	P6SS3X3G	C94006-T15P	S5808
C4/ C5-..L-16	T09P-2	L84017-T09P	CN14U20S-2R-SET	171.19-620	P6SS3X3G	C94006-T15P	S5808
C6-..R-16	T09P-2	L84017-T09P	CP14U20S-2L-SET	171.19-620	P6SS3X3G	C94006-T15P	S5808
C6-..L-16	T09P-2	L84017-T09P	CP14U20S-2R-SET	171.19-620	P6SS3X3G	C94006-T15P	S5808

Accessories

For size	Duo coolant plug screw	Insert clamping torque	Shim key	Torque key
C4/ C5-..R-16	 P6SS3X5	 2.0NM	 T15P-2	 T00-09P20
C4/ C5-..L-16	P6SS3X5	2.0NM	T15P-2	T00-09P20
C6-..R-16	P6SS3X5	2.0NM	T15P-2	T00-09P20
C6-..L-16	P6SS3X5	2.0NM	T15P-2	T00-09P20

General ISO Turning
Holders

Steadyline®

MDT

Mini-Shaft™

Grooving

Parting-off

X4

Adapters
Clamping units

Accessories and
Spare parts

Workpiece
materials

C.-DVVBN...JETI – Toolholders for inserts VBMT, VBGT, VBGW, VBW and VCGT – Metric/ Inch

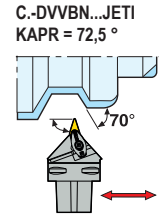
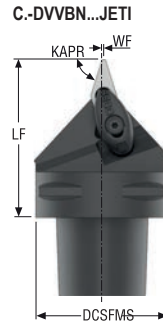
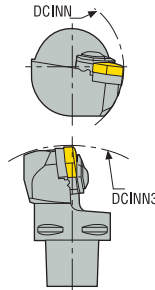

CTWS



- For inserts program, see page(s) 563, 564, 564, 594, 602,
- For more information on Jetstream Tooling® (High pressure coolant) and accessories, please see page(s) 38, 85-89, 1002
- GAMO° = Rake angle, LAMS° = Inclination angle
- CTMS = Seco-Capto™ size
- CTWS = Insert shape and size
- For holder code key, see page(s) 11-12
- * Max coolant pressure
- ** Jetstream Tooling® Duo, see page(s) 38, 85-89
- For JETI coolant clamp it is recommended to set regular screw and double O-rings exchange rate to keep the safety first and minimize leakage for the application at hand
- Right-hand version shown
- Please check availability at www.secotools.com / Seco Online Store

Designation	Item number	CTMS	**	DCSFMS	WF	LF	DCINN	DCINN3	CP*	KAPR°	GAMO°	LAMS°	Weight	CTWS
				mm Inch	mm Inch	mm Inch	mm Inch	mm Inch	bar psi	kg lbs				
C4-DVVBN-00055-16JETI	03289604	C4	Duo	40,0 1.575	0,6 0.024	55,0 2.165	-	250,0 9.843	70,0 1015.3	72,5	0,0	0,0	0,4 0.880	VB..VC..1604 VB..VC..33.
C5-DVVBN-00060-16JETI	03289613	C5	Duo	50,0 1.969	0,6 0.024	60,0 2.362	-	250,0 9.843	70,0 1015.3	72,5	0,0	0,0	0,6 1.320	VB..VC..1604 VB..VC..33.
C6-DVVBN-00065-16JETI	03289620	C6	Duo	63,0 2.480	0,6 0.024	65,0 2.559	-	250,0 9.843	70,0 1015.3	72,5	0,0	0,0	1,0 2.200	VB..VC..1604 VB..VC..33.

Spare Parts

For size	Clamp key	Clamp screw	Coolant kit	Insert shim	Plug screw	Shim screw	Spring
-16	 T09P-2	 L84017-T09P	 CP14U20S-2L-SET	 171.19-620	 P6SS3X3G	 C94006-T15P	 S5808

Accessories

For size	Duo coolant plug screw	Insert clamping torque	Shim key	Torque key
-16	 P6SS3X5	 2.0NM	 T15P-2	 T00-09P20

C.-DWLNR/L...JETI – Toolholders for inserts WNGA, WNGG, WNMA, WNMG and WNMM – Metric / Inch

C.-DWLNR/L...JETI
KAPR = 95,0°

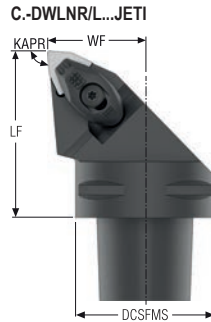
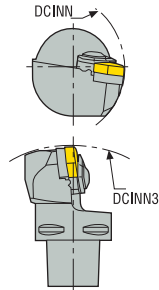
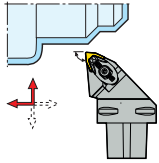

- For inserts program, see page(s) 568, 569, 570, 571, 596
- For more information on Jetstream Tooling® (High pressure coolant) and accessories, please see page(s) 38, 85-89, 1002
- GAMO° = Rake angle, LAMS° = Inclination angle
- CTMS = Seco-Capto™ size
- CTWS = Insert shape and size
- For holder code key, see page(s) 11-12
- * Max coolant pressure
- ** Jetstream Tooling® Duo, see page(s) 38, 85-89
- For JETI coolant clamp it is recommended to set regular screw and double O-rings exchange rate to keep the safety first and minimize leakage for the application at hand
- Right-hand version shown
- * Use the right shim & the right screw for the selected insert. For details, see page 99
- Please check availability at www.secotools.com / Seco Online Store



Designation	Item number	CTMS	**	DCSFMS	WF	LF	DCINN	DCINN3	CP*	KAPR°	GAMO°	LAMS°	Weight	CTWS
				mm Inch	mm Inch	mm Inch	mm Inch	mm Inch	bar psi				kg lbs	
C4-DWLNR-27050-06JETI	03282191	C4	Duo	40,0 1.575	27,0 1.063	50,0 1.969	200,0 7.874	220,0 8.661	70,0 1015.3	95,0	-6,0	-6,0	0,4 0.880	WN..0604.. WN..33.
C4-DWLN-27050-06JETI	03282189	C4	Duo	40,0 1.575	27,0 1.063	50,0 1.969	200,0 7.874	220,0 8.661	70,0 1015.3	95,0	-6,0	-6,0	0,4 0.880	WN..0604.. WN..33.
C4-DWLNR-27050-08JETI	03282192	C4	Duo	40,0 1.575	27,0 1.063	50,0 1.969	200,0 7.874	220,0 8.661	70,0 1015.3	95,0	-6,0	-6,0	0,5 1.100	WN..0804/WN..0806 WN..43/WN..44*
C4-DWLN-27050-08JETI	03282190	C4	Duo	40,0 1.575	27,0 1.063	50,0 1.969	200,0 7.874	220,0 8.661	70,0 1015.3	95,0	-6,0	-6,0	0,5 1.100	WN..0804/WN..0806 WN..43/WN..44*
C5-DWLNR-35060-06JETI	03282212	C5	Duo	50,0 1.969	35,0 1.378	60,0 2.362	235,0 9.252	250,0 9.843	70,0 1015.3	95,0	-6,0	-6,0	0,8 1.760	WN..0604.. WN..33.
C5-DWLN-35060-06JETI	03282211	C5	Duo	50,0 1.969	35,0 1.378	60,0 2.362	235,0 9.252	250,0 9.843	70,0 1015.3	95,0	-6,0	-6,0	0,8 1.760	WN..0604.. WN..33.
C5-DWLNR-35060-08JETI	03282459	C5	Duo	50,0 1.969	35,0 1.378	60,0 2.362	250,0 9.843	250,0 9.843	70,0 1015.3	95,0	-6,0	-6,0	0,8 1.760	WN..0804/WN..0806 WN..43/WN..44*
C5-DWLN-35060-08JETI	03282458	C5	Duo	50,0 1.969	35,0 1.378	60,0 2.362	250,0 9.843	250,0 9.843	70,0 1015.3	95,0	-6,0	-6,0	0,8 1.760	WN..0804/WN..0806 WN..43/WN..44*
C6-DWLNR-45065-08JETI	03282237	C6	Duo	63,0 2.480	45,0 1.772	65,0 2.559	235,0 9.252	250,0 9.843	70,0 1015.3	95,0	-6,0	-6,0	1,3 2.870	WN..0804/WN..0806 WN..43/WN..44*
C6-DWLN-45065-08JETI	03282236	C6	Duo	63,0 2.480	45,0 1.772	65,0 2.559	235,0 9.252	250,0 9.843	70,0 1015.3	95,0	-6,0	-6,0	1,3 2.870	WN..0804/WN..0806 WN..43/WN..44*

Spare Parts

For size	Clamp screw	Coolant kit	Insert shim	Plug screw	Shim/clamp key	Shim screw	Spring
-06	L84017-T09P	CN14L00R-2-SET	DWN060310	P6SS3X3G	T09P-2	C03007-T09P	S5808
-08	L85021-T15P	CN17L00R-2-SET	DWN080416	P6SS3X3G	T15P-2	C04008-T15P	S7111

General ISO Turning Holders
Steadyline®
MDT
Mini-Shaft™
Grooving
Parting-off
X4
Adapters Clamping units
Accessories and Spare parts
Workpiece materials

Accessories

For size	Duo coolant plug screw	Insert clamping torque	Torque key
-06	 P6SS3X5	 2.0NM	 T00-09P20
-08	P6SS3X5	3.5NM	T00-15P35

C.-PCLNR/L...JETL – Toolholders for inserts CNGA, CNGG, CNMA, CNMG and CNMM – Metric/ Inch

C.-PCLNR/L...JETL
KAPR = 95,0°

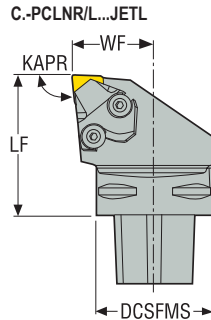
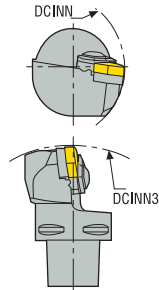
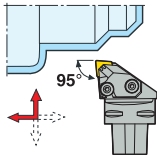

- For inserts program, see page(s) 527, 528, 529, 530, 531, 532, 533, 575, 576
- For more information on Jetstream Tooling® (High pressure coolant) and accessories, please see page(s) 38, 85-89, 1002
- GAMO° = Rake angle, LAMS° = Inclination angle
- CTMS = Seco-Capto™ size
- CTWS = Insert shape and size
- For holder code key, see page(s) 11-12
- * Max coolant pressure
- ** Jetstream Tooling® Duo, see page(s) 38, 85-89
- For JETI coolant clamp it is recommended to set regular screw and double O-rings exchange rate to keep the safety first and minimize leakage for the application at hand
- Right-hand version shown
- Please check availability at www.secotools.com / Seco Online Store

Designation	Item number	CTMS	**	DCSFMS		WF	LF	DCINN	DCINN3	CP*	KAPR°	GAMO°	LAMS°	Weight	CTWS						
				mm	Inch	mm	Inch	mm	Inch	mm	Inch	mm	Inch	bar		psi	kg	lbs			
C4-PCLNR-27050-12JETL	02841209	C4	-	40,0	1.575	27,0	1.063	50,0	1.969	75,0	2.953	165,0	6.496	70,0	1015.3	95,0	-6,0	-6,0	0,5	1.100	CN..1204.. CN..43.
C4-PCLNL-27050-12JETL	02841211	C4	-	40,0	1.575	27,0	1.063	50,0	1.969	75,0	2.953	165,0	6.496	70,0	1015.3	95,0	-6,0	-6,0	0,5	1.100	CN..1204.. CN..43.
C5-PCLNR-35060-12JETL	02841212	C5	-	50,0	1.969	35,0	1.378	60,0	2.362	95,0	3.740	165,0	6.496	70,0	1015.3	95,0	-6,0	-6,0	0,9	1.980	CN..1204.. CN..43.
C5-PCLNL-35060-12JETL	02841222	C5	-	50,0	1.969	35,0	1.378	60,0	2.362	95,0	3.740	165,0	6.496	70,0	1015.3	95,0	-6,0	-6,0	0,9	1.980	CN..1204.. CN..43.
C6-PCLNR-45065-12JETL	02841210	C6	-	63,0	2.480	45,0	1.772	65,0	2.559	121,0	4.764	165,0	6.496	70,0	1015.3	95,0	-6,0	-6,0	1,5	3.310	CN..1204.. CN..43.
C6-PCLNL-45065-12JETL	02841208	C6	-	63,0	2.480	45,0	1.772	65,0	2.559	121,0	4.764	165,0	6.496	70,0	1015.3	95,0	-6,0	-6,0	1,5	3.310	CN..1204.. CN..43.
C6-PCLNR-45065-16JETL	02841225	C6	-	63,0	2.480	45,0	1.772	65,0	2.559	150,0	5.906	200,0	7.874	70,0	1015.3	95,0	-6,0	-6,0	1,4	3.090	CN..1606.. CN..54.
C6-PCLNL-45065-16JETL	02841224	C6	-	63,0	2.480	45,0	1.772	65,0	2.559	121,0	4.764	165,0	6.496	70,0	1015.3	95,0	-6,0	-6,0	1,4	3.090	CN..1606.. CN..54.

Spare Parts

For size	Inducer	Inducer screw	Insert lever	Insert shim	Lever/inducer key	Lever screw	O-ring	Punch	Shim pin
...R-12	CILC12RA-F	117.26-655	PP4713	PCN120308	3SMS795	LS0818	ORING-8X1.5	MP0912	RP6757
...L-12	CILC12LA-F	117.26-655	PP4713	PCN120308	3SMS795	LS0818	ORING-8X1.5	MP0912	RP6757
...R-16	CILC16RA-F	117.26-655	PP6017	PCN160412	3SMS795	LS0820	ORING-8X1.5	MP1519	RP8286
...L-16	CILC16LA-F	117.26-655	PP6017	PCN160412	3SMS795	LS0820	ORING-8X1.5	MP1519	RP8286

General ISO Turning Holders
Steadyline®
MDT
Mini-Shaft™
Grooving
Parting-off
X4
Adapters Clamping units
Accessories and Spare parts
Workpiece materials

General ISO Turning
Holders

Accessories

For size	Inducer
	
...R-12	CILC12RA-R
...L-12	CILC12LA-R
...R-16	CILC16RA-R
...L-16	CILC16LA-R

Steadyline®

MDT

Mini-Shaft™

Grooving

Parting-off

X4

Adapters
Clamping units

Accessories and
Spare parts

Workpiece
materials

C.-PDJNR/L...JETL – Toolholders for inserts DNGA, DNGG, DNGM, DNMA, DNMG, DNMM and DNMX – Metric/ Inch

C.-PDJNR/L...JETL
KAPR = 93,0°

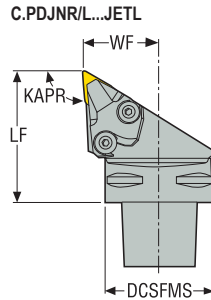
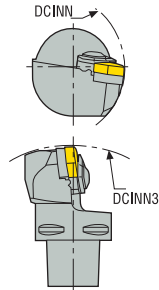
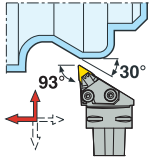

















- For inserts program, see page(s) 537, 538, 539, 540, 541, 579, 580, 598
- For more information on Jetstream Tooling® (High pressure coolant) and accessories, please see page(s) 38, 85-89, 1002
- GAMO° = Rake angle, LAMS° = Inclination angle
- CTMS = Seco-Capto™ size
- CTWS = Insert shape and size
- For holder code key, see page(s) 11-12
- * Max coolant pressure
- ** Jetstream Tooling® Duo, see page(s) 38, 85-89
- For JETI coolant clamp it is recommended to set regular screw and double O-rings exchange rate to keep the safety first and minimize leakage for the application at hand
- Right-hand version shown
- * Use the right shim & the right screw for the selected insert. For details, see page 99
- Please check availability at www.secotools.com / Seco Online Store

Designation	Item number	CTMS	**	DCSFMS	WF	LF	DCINN	DCINN3	CP*	KAPR°	GAMO°	LAMS°	Weight	CTWS
				mm Inch	mm Inch	mm Inch	mm Inch	mm Inch	bar psi				kg lbs	
C4-PDJNR-27055-15JETL	02841207	C4	-	40,0 1.575	27,0 1.063	55,0 2.165	75,0 2.953	165,0 6.496	70,0 1015.3	93,0	-6,0	-6,0	0,5 1.100	DN.1504/DN..1506 DN..43/DN..44*
C4-PDJNR-27055-15-04JETL	02889852	C4	-	40,0 1.575	27,0 1.063	55,0 2.165	75,0 2.953	165,0 6.496	70,0 1015.3	93,0	-6,0	-6,0	0,5 1.100	DN.1504/DN..1506 DN..43/DN..44*
C4-PDJNL-27055-15JETL	02841217	C4	-	40,0 1.575	27,0 1.063	55,0 2.165	75,0 2.953	165,0 6.496	70,0 1015.3	93,0	-6,0	-6,0	0,5 1.100	DN.1504/DN..1506 DN..43/DN..44*
C4-PDJNL-27055-15-04JETL	02889853	C4	-	40,0 1.575	27,0 1.063	55,0 2.165	75,0 2.953	165,0 6.496	70,0 1015.3	93,0	-6,0	-6,0	0,5 1.100	DN.1504/DN..1506 DN..43/DN..44*
C5-PDJNR-35060-15JETL	02841214	C5	-	50,0 1.969	35,0 1.378	60,0 2.362	95,0 3.740	165,0 6.496	70,0 1015.3	93,0	-6,0	-6,0	0,8 1.760	DN.1504/DN..1506 DN..43/DN..44*
C5-PDJNR-35060-15-04JETL	02889855	C5	-	50,0 1.969	35,0 1.378	60,0 2.362	95,0 3.740	165,0 6.496	70,0 1015.3	93,0	-6,0	-6,0	0,8 1.760	DN.1504/DN..1506 DN..43/DN..44*
C5-PDJNL-35060-15JETL	02841218	C5	-	50,0 1.969	35,0 1.378	60,0 2.362	95,0 3.740	165,0 6.496	70,0 1015.3	93,0	-6,0	-6,0	0,8 1.760	DN.1504/DN..1506 DN..43/DN..44*
C5-PDJNL-35060-15-04JETL	02889857	C5	-	50,0 1.969	35,0 1.378	60,0 2.362	95,0 3.740	165,0 6.496	70,0 1015.3	93,0	-6,0	-6,0	0,8 1.760	DN.1504/DN..1506 DN..43/DN..44*
C6-PDJNR-45065-15JETL	02841216	C6	-	62,0 2.441	45,0 1.772	65,0 2.559	121,0 4.764	165,0 6.496	70,0 1015.3	93,0	-6,0	-6,0	1,2 2.650	DN.1504/DN..1506 DN..43/DN..44*
C6-PDJNR-45065-15-04JETL	02889854	C6	-	62,0 2.441	45,0 1.772	65,0 2.559	121,0 4.764	165,0 6.496	70,0 1015.3	93,0	-6,0	-6,0	1,2 2.650	DN.1504/DN..1506 DN..43/DN..44*
C6-PDJNL-45065-15JETL	02841213	C6	-	62,0 2.441	45,0 1.772	65,0 2.559	121,0 4.764	165,0 6.496	70,0 1015.3	93,0	-6,0	-6,0	1,2 2.650	DN.1504/DN..1506 DN..43/DN..44*
C6-PDJNL-45065-15-04JETL	02889856	C6	-	62,0 2.441	45,0 1.772	65,0 2.559	121,0 4.764	165,0 6.496	70,0 1015.3	93,0	-6,0	-6,0	1,2 2.650	DN.1504/DN..1506 DN..43/DN..44*

General ISO Turning Holders
Steadyline®
MDT
Mini-Shaft™
Grooving
Parting-off
X4
Adapters Clamping units
Accessories and Spare parts
Workpiece materials

General ISO Turning Holders
Steadyline®
MDT
Mini-Shaft™
Grooving
Parting-off
X4
Adapters Clamping units
Accessories and Spare parts
Workpiece materials

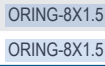
Spare Parts

For size	Inducer	Inducer screw	Insert lever	Insert shim	Lever/inducer key	Lever screw	O-ring	Punch	Shim pin
...R-15	 CILD15RA-F	 117.26-655	 PP4716	 PDN150308	 3SMS795	 LS0822	 ORING-8X1.5	 MP0912	 RP6757
...R-15-04	CILD15RA-F	117.26-655	PP4716	PDN150408	3SMS795	LS0818	ORING-8X1.5	MP0912	RP6757
...L-15	 CILD15LA-F	 117.26-655	 PP4716	 PDN150308	 3SMS795	 LS0822	 ORING-8X1.5	 MP0912	 RP6757
...L-15-04	CILD15LA-F	117.26-655	PP4716	PDN150408	3SMS795	LS0818	ORING-8X1.5	MP0912	RP6757

Accessories

For size	Inducer
...R-15	 CILD15RA-R
...R-15-04	CILD15RA-R
...L-15	CILD15LA-R
...L-15-04	CILD15LA-R

C.-PTJNR/L...JETL – Toolholders for inserts TNGA, TNMA, TNMG, TNMM and TNMX – Metric / Inch

C.-PTJNR/L...JETL
KAPR = 93,0°

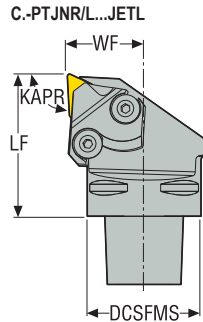
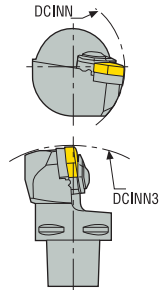
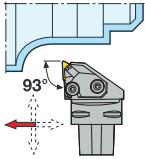

- For inserts program, see page(s) 558, 559, 560, 561, 590, 593
- For more information on Jetstream Tooling® (High pressure coolant) and accessories, please see page(s) 38, 85-89, 1002
- GAMO° = Rake angle, LAMS° = Inclination angle
- CTMS = Seco-Capto™ size
- CTWS = Insert shape and size
- For holder code key, see page(s) 11-12
- * Max coolant pressure
- ** Jetstream Tooling® Duo, see page(s) 38, 85-89
- For JETI coolant clamp it is recommended to set regular screw and double O-rings exchange rate to keep the safety first and minimize leakage for the application at hand
- Right-hand version shown
- Please check availability at www.secotools.com / Seco Online Store

Designation	Item number	CTMS	**	DCSFMS		WF		LF		DCINN		CP*	KAPR°	GAMO°	LAMS°	Weight	CTWS				
				mm	Inch	mm	Inch	mm	Inch	mm	Inch							mm	Inch	bar	psi
C4-PTJNR-27050-16JETL	02841245	C4	-	40,0	1.575	27,0	1.063	50,0	1.969	75,0	2.953	165,0	6.496	70,0	1015.3	93,0	-6,0	-6,0	0,5	1.100	TN..1604.. TN..33.
C4-PTJNL-27050-16JETL	02841246	C4	-	40,0	1.575	27,0	1.063	50,0	1.969	75,0	2.953	165,0	6.496	70,0	1015.3	93,0	-6,0	-6,0	0,5	1.100	TN..1604.. TN..33.
C6-PTJNR-45065-16JETL	02841260	C6	-	63,0	2.480	45,0	1.772	65,0	2.559	121,0	4.764	165,0	6.496	70,0	1015.3	93,0	-6,0	-6,0	1,5	3.310	TN..1604.. TN..33.
C6-PTJNL-45065-16JETL	02841259	C6	-	63,0	2.480	45,0	1.772	65,0	2.559	121,0	4.764	165,0	6.496	70,0	1015.3	93,0	-6,0	-6,0	1,5	3.310	TN..1604.. TN..33.

Spare Parts

For size	Inducer	Inducer key	Inducer screw	Insert lever	Insert shim	Lever key	Lever screw	O-ring	Punch	Shim pin
...R-16										
...R-16	CILT16RA-F	3SMS795	117.26-655	PP3612	PTN160208	2.5SMS795	LS0616	ORING-8X1.5	MP0912	RP5152
...L-16	CILT16LA-F	3SMS795	117.26-655	PP3612	PTN160208	2.5SMS795	LS0616	ORING-8X1.5	MP0912	RP5152

Accessories

For size	Insert clamping torque	Torque key	
...R-16		3.0NM	H00-2530
...L-16		3.0NM	H00-2530

General ISO Turning Holders
Steadyline®
MDT
Mini-Shaft™
Grooving
Parting-off
X4
Adapters Clamping units
Accessories and Spare parts
Workpiece materials

C.-PVJNR/L...JETL – Toolholders for inserts VNGA, VNGG, VNGM and VNMG – Metric/ Inch

General ISO Turning Holders
Steadyline®
MDT
Mini-Shaft™
Grooving
Parting-off
X4
Adapters Clamping units
Accessories and Spare parts
Workpiece materials

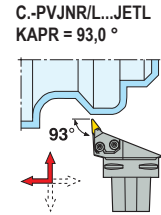
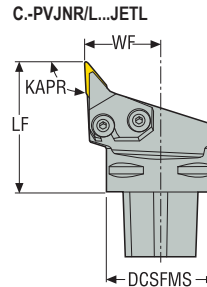
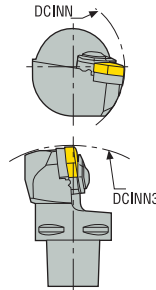

- For inserts program, see page(s) 565, 566, 595
- For more information on Jetstream Tooling® (High pressure coolant) and accessories, please see page(s) 38, 85-89, 1002
- GAMO° = Rake angle, LAMS° = Inclination angle
- CTMS = Seco-Capto™ size
- CTWS = Insert shape and size
- For holder code key, see page(s) 11-12
- * Max coolant pressure
- ** Jetstream Tooling® Duo, see page(s) 38, 85-89
- For JETI coolant clamp it is recommended to set regular screw and double O-rings exchange rate to keep the safety first and minimize leakage for the application at hand
- Right-hand version shown
- Please check availability at www.secotools.com / Seco Online Store

Designation	Item number	CTMS	**	DCSFMS		LF	DCINN	DCINN3	CP*	KAPR°	GAMO°	LAMS°	Weight	CTWS
				mm Inch	mm Inch	mm Inch	mm Inch	mm Inch	bar psi					
C4-PVJNR-27060-16JETL	02841244	C4	-	40,0 1.575	27,2 1.071	60,0 2.362	75,0 2.953	165,0 6.496	70,0 1015.3	93,0	-4,5	-13,5	0,5 1.100	VN..1604.. VN..33.
C4-PVJNL-27060-16JETL	02841253	C4	-	40,0 1.575	27,2 1.071	60,0 2.362	75,0 2.953	165,0 6.496	70,0 1015.3	93,0	-4,5	-13,5	0,5 1.100	VN..1604.. VN..33.
C5-PVJNR-35060-16JETL	02841250	C5	-	50,0 1.969	35,0 1.378	60,0 2.362	95,0 3.740	165,0 6.496	70,0 1015.3	93,0	-4,5	-13,5	0,7 1.540	VN..1604.. VN..33.
C5-PVJNL-35060-16JETL	02841255	C5	-	50,0 1.969	35,0 1.378	60,0 2.362	95,0 3.740	165,0 6.496	70,0 1015.3	93,0	-4,5	-13,5	0,7 1.540	VN..1604.. VN..33.
C6-PVJNR-45065-16JETL	02841247	C6	-	63,0 2.480	45,0 1.772	65,0 2.559	121,0 4.764	165,0 6.496	70,0 1015.3	93,0	-4,5	-13,5	1,3 2.870	VN..1604.. VN..33.
C6-PVJNL-45065-16JETL	02841248	C6	-	63,0 2.480	45,0 1.772	65,0 2.559	121,0 4.764	165,0 6.496	70,0 1015.3	93,0	-4,5	-13,5	1,3 2.870	VN..1604.. VN..33.

Spare Parts

For size	Inducer	Inducer key	Inducer screw	Insert lever	Insert shim	Lever key	Lever screw	O-ring	Punch	Shim pin
...R-16	CILV16RC-F	3SMS795	117.26-655	PP3512	PVN160304	2.5SMS795	LS0616	ORING-6.07X1.78	MP0912	RP5153
...L-16	CILV16LC-F	3SMS795	117.26-655	PP3512	PVN160304	2.5SMS795	LS0616	ORING-6.07X1.78	MP0912	RP5153

Accessories

For size	Insert clamping torque	Torque key
...R-16	3.0NM	H00-2530
...L-16	3.0NM	H00-2530

C.-PWLNR/L...JETL – Toolholders for inserts WNGA, WNMA, WNMG and WNMM – Metric / Inch

C.-PWLNR/L...JETL
KAPR = 95,0°

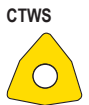
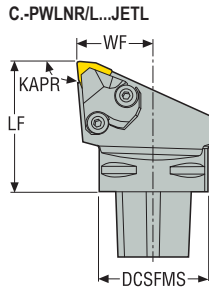
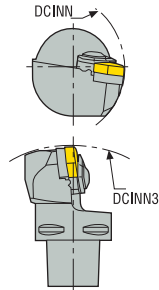
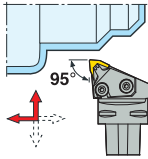

- For inserts program, see page(s) 568, 569, 570, 571, 596
- For more information on Jetstream Tooling® (High pressure coolant) and accessories, please see page(s) 38, 85-89, 1002
- GAMO° = Rake angle, LAMS° = Inclination angle
- CTMS = Seco-Capto™ size
- CTWS = Insert shape and size
- For holder code key, see page(s) 11-12
- * Max coolant pressure
- ** Jetstream Tooling® Duo, see page(s) 38, 85-89
- For JETI coolant clamp it is recommended to set regular screw and double O-rings exchange rate to keep the safety first and minimize leakage for the application at hand
- Right-hand version shown
- * Use the right shim & the right screw for the selected insert. For details, see page 99
- Please check availability at www.secotools.com / Seco Online Store



Designation	Item number	CTMS	**	DCSFMS	WF	LF	DCINN	DCINN3	CP*	KAPR°	GAMO°	LAMS°	Weight	CTWS
				mm Inch	mm Inch	mm Inch	mm Inch	mm Inch	bar psi				kg lbs	
C4-PWLNR-27050-06JETL	02841226	C4	-	40,0 1.575	27,0 1.063	50,0 1.969	75,0 2.953	165,0 6.496	70,0 1015.3	95,0	-6,0	-6,0	0,5 1.100	WN..0604.. WN..33.
C4-PWLN-27050-06JETL	02841228	C4	-	40,0 1.575	27,0 1.063	50,0 1.969	75,0 2.953	165,0 6.496	70,0 1015.3	95,0	-6,0	-6,0	0,5 1.100	WN..0604.. WN..33.
C4-PWLNR-27050-08JETL	02841206	C4	-	40,0 1.575	27,0 1.063	50,0 1.969	75,0 2.953	165,0 6.496	70,0 1015.3	95,0	-6,0	-6,0	0,4 0.880	WN..0804/WN..0806 WN..43/WN..44*
C4-PWLN-27050-08JETL	02841219	C4	-	40,0 1.575	27,0 1.063	50,0 1.969	75,0 2.953	165,0 6.496	70,0 1015.3	95,0	-6,0	-6,0	0,4 0.880	WN..0804/WN..0806 WN..43/WN..44*
C5-PWLNR-35060-06JETL	02841227	C5	-	50,0 1.969	35,0 1.378	60,0 2.362	95,0 3.740	165,0 6.496	70,0 1015.3	95,0	-6,0	-6,0	0,8 1.760	WN..0604.. WN..33.
C5-PWLN-35060-06JETL	02841229	C5	-	50,0 1.969	35,0 1.378	60,0 2.362	95,0 3.740	165,0 6.496	70,0 1015.3	95,0	-6,0	-6,0	0,8 1.760	WN..0604.. WN..33.
C5-PWLNR-35060-08JETL	02841221	C5	-	50,0 1.969	35,0 1.378	60,0 2.362	95,0 3.740	165,0 6.496	70,0 1015.3	95,0	-6,0	-6,0	0,8 1.760	WN..0804/WN..0806 WN..43/WN..44*
C5-PWLN-35060-08JETL	02841223	C5	-	50,0 1.969	35,0 1.378	60,0 2.362	95,0 3.740	165,0 6.496	70,0 1015.3	95,0	-6,0	-6,0	0,8 1.760	WN..0804/WN..0806 WN..43/WN..44*
C6-PWLNR-45065-08JETL	02841220	C6	-	63,0 2.480	45,0 1.772	65,0 2.559	121,0 4.764	165,0 6.496	70,0 1015.3	95,0	-6,0	-6,0	1,3 2.870	WN..0804/WN..0806 WN..43/WN..44*
C6-PWLN-45065-08JETL	02841215	C6	-	63,0 2.480	45,0 1.772	65,0 2.559	121,0 4.764	165,0 6.496	70,0 1015.3	95,0	-6,0	-6,0	1,3 2.870	WN..0804/WN..0806 WN..43/WN..44*

Spare Parts

For size	Inducer	Inducer key	Inducer screw	Insert lever	Insert shim	Lever/inducer key	Lever key	Lever screw	O-ring	Punch	Shim pin
...R-06	CILW06RA-F	3SMS795	117.26-655	PP3612	PWN060312	-	2.5SMS795	LS0616	ORING-8X1.5	MP0912	RP5152
...L-06	CILW06LA-F	3SMS795	117.26-655	PP3612	PWN060312	-	2.5SMS795	LS0616	ORING-8X1.5	MP0912	RP5152
...R-08	CILW08RA-F	-	117.26-655	PP4713	PWN080312	3SMS795	-	LS0818	ORING-8X1.5	MP0912	RP6757
...L-08	CILW08LA-F	-	117.26-655	PP4713	PWN080312	3SMS795	-	LS0818	ORING-8X1.5	MP0912	RP6757

General ISO Turning Holders
Steadyline®
MDT
Mini-Shaft™
Grooving
Parting-off
X4
Adapters Clamping units
Accessories and Spare parts
Workpiece materials

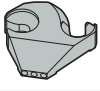
Accessories

For size	Inducer	Insert clamping torque	Torque key
...R-06	 CILW06RA-R	 3.0NM	 H00-2530
...L-06	CILW06LA-R	3.0NM	H00-2530
...R-08	CILW08RA-R	-	-
...L-08	CILW08LA-R	-	-

General ISO Turning
Holders

Steadyline®

MDT

Mini-Shaft™

Grooving

Parting-off

X4

Adapters
Clamping units

Accessories and
Spare parts

Workpiece
materials

C.-SCLCR/L...JET – Toolholders for inserts CCGT, CCGW, CCMT and CCMW – Metric / Inch

C.-SCLCR/L...JET
KAPR = 95,0°

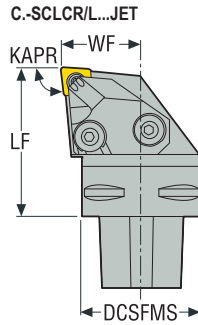
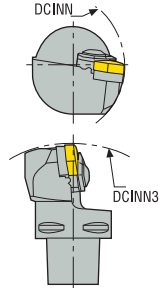
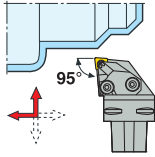

- For inserts program, see page(s) 522, 523, 524, 525, 573, 574, 597, 599
- For more information on Jetstream Tooling® (High pressure coolant) and accessories, please see page(s) 38, 85-89, 1002
- GAMO° = Rake angle, LAMS° = Inclination angle
- CTMS = Seco-Capto™ size
- CTWS = Insert shape and size
- For holder code key, see page(s) 11-12
- * Max coolant pressure
- ** Jetstream Tooling® Duo, see page(s) 38, 85-89
- For JETI coolant clamp it is recommended to set regular screw and double O-rings exchange rate to keep the safety first and minimize leakage for the application at hand
- Right-hand version shown
- Please check availability at www.secotools.com / Seco Online Store



Designation	Item number	CTMS	**	DCSFMS		WF	LF	DCINN	DCINN3	CP*	KAPR°	GAMO°	LAMS°	Weight	CTWS							
				mm	Inch	mm	Inch	mm	Inch	mm	Inch	bar	psi	kg		lbs						
C4-SCLCR-27050-09JET	02602959	C4	-	40,0	1.575	27,0	1.063	50,0	1.969	2.953	75,0	2.953	165,0	6.496	70,0	1015.3	95,0	0,0	0,0	0,5	1.100	CC..09T3.. CC..32.5.
C4-SCLCL-27050-09JET	02603160	C4	-	40,0	1.575	27,0	1.063	50,0	1.969	2.953	75,0	2.953	165,0	6.496	70,0	1015.3	95,0	0,0	0,0	0,5	1.100	CC..09T3.. CC..32.5.
C4-SCLCR-27050-12JET	02603161	C4	-	40,0	1.575	27,0	1.063	50,0	1.969	2.953	75,0	2.953	165,0	6.496	70,0	1015.3	95,0	0,0	0,0	0,5	1.100	CC..1204.. CC..43.
C4-SCLCL-27050-12JET	02603162	C4	-	40,0	1.575	27,0	1.063	50,0	1.969	2.953	75,0	2.953	165,0	6.496	70,0	1015.3	95,0	0,0	0,0	0,5	1.100	CC..1204.. CC..43.
C5-SCLCR-35060-12JET	02603165	C5	-	50,0	1.969	35,0	1.378	60,0	2.362	3.740	95,0	3.740	165,0	6.496	70,0	1015.3	95,0	0,0	0,0	0,7	1.540	CC..1204.. CC..43.
C5-SCLCL-35060-12JET	02603166	C5	-	50,0	1.969	35,0	1.378	60,0	2.362	3.740	95,0	3.740	165,0	6.496	70,0	1015.3	95,0	0,0	0,0	0,7	1.540	CC..1204.. CC..43.
C6-SCLCR-45065-12JET	02603169	C6	-	63,0	2.480	45,0	1.772	65,0	2.559	4.764	121,0	4.764	165,0	6.496	70,0	1015.3	95,0	0,0	0,0	1,3	2.870	CC..1204.. CC..43.
C6-SCLCL-45065-12JET	02603170	C6	-	63,0	2.480	45,0	1.772	65,0	2.559	4.764	121,0	4.764	165,0	6.496	70,0	1015.3	95,0	0,0	0,0	1,3	2.870	CC..1204.. CC..43.

Spare Parts

For size	Inducer kit	Inducer screw	Insert/inducer key	Insert screw	Insert shim	O-ring	Shim screw
...R-09	JET-CIKC12RC-KIT	117.26-655	3SMS795/T15P	C04008-T15P	-	ORING-8X1.5	-
...L-09	JET-CIKC12LC-KIT	117.26-655	3SMS795/T15P	C04008-T15P	-	ORING-8X1.5	-
...R-12	JET-CIKC12RC-KIT	117.26-655	3SMS795/T15P	C05012-T15P	123.19-621	ORING-8X1.5	CA5008
...L-12	JET-CIKC12LC-KIT	117.26-655	3SMS795/T15P	C05012-T15P	123.19-621	ORING-8X1.5	CA5008

General ISO Turning Holders
Steadyline®
MDT
Mini-Shaft™
Grooving
Parting-off
X4
Adapters Clamping units
Accessories and Spare parts
Workpiece materials

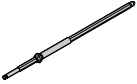
Accessories

For size	Insert clamping torque	Replacement blade	Shim key	Torque key
...R-09	3.5NM 	T00-15P 	- 	T00-15P35 
...L-09	3.5NM	T00-15P	-	T00-15P35
...R-12	5.0NM	T00-15P	5SMS795	T00-15P50
...L-12	5.0NM	T00-15P	5SMS795	T00-15P50

General ISO Turning
Holders

Steadyline®

MDT

Mini-Shaft™

Grooving

Parting-off

X4

Adapters
Clamping units

Accessories and
Spare parts

Workpiece
materials

C.-SDJCR/L...JET – Toolholders for inserts DCGT, DCGW, DCMT and DCMW – Metric / Inch

C.-SDJCR/L...JET
KAPR = 93,0°

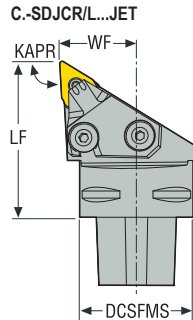
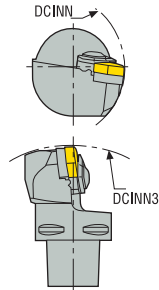
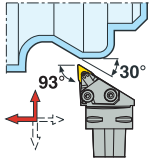

- For inserts program, see page(s) 534, 535, 536, 578, 600
- For more information on Jetstream Tooling® (High pressure coolant) and accessories, please see page(s) 38, 85-89, 1002
- GAMO° = Rake angle, LAMS° = Inclination angle
- CTMS = Seco-Capto™ size
- CTWS = Insert shape and size
- For holder code key, see page(s) 11-12
- * Max coolant pressure
- ** Jetstream Tooling® Duo, see page(s) 38, 85-89
- For JETI coolant clamp it is recommended to set regular screw and double O-rings exchange rate to keep the safety first and minimize leakage for the application at hand
- Right-hand version shown
- Please check availability at www.secotools.com / Seco Online Store

Designation	Item number	CTMS	**	DCSFMS		WF	LF	DCINN	DCINN3	CP*	KAPR°	GAMO°	LAMS°	Weight	CTWS						
				mm	Inch											mm	Inch	kg	lbs		
C4-SDJCR-27050-11JET	02603171	C4	-	40,0	1.575	27,0	1.063	50,0	1.969	75,0	2.953	165,0	6.496	70,0	1015.3	93,0	0,0	0,0	0,4	0.880	DC..11T3.. DC..32.5.
C4-SDJCL-27050-11JET	02603172	C4	-	40,0	1.575	27,0	1.063	50,0	1.969	75,0	2.953	165,0	6.496	70,0	1015.3	93,0	0,0	0,0	0,4	0.880	DC..11T3.. DC..32.5.
C5-SDJCR-35060-11JET	02603173	C5	-	50,0	1.969	35,0	1.378	60,0	2.362	95,0	3.740	165,0	6.496	70,0	1015.3	93,0	0,0	0,0	0,7	1.540	DC..11T3.. DC..32.5.
C5-SDJCL-35060-11JET	02603174	C5	-	50,0	1.969	35,0	1.378	60,0	2.362	95,0	3.740	165,0	6.496	70,0	1015.3	93,0	0,0	0,0	0,7	1.540	DC..11T3.. DC..32.5.
C6-SDJCR-45065-11JET	02603175	C6	-	63,0	2.480	45,0	1.772	65,0	2.559	121,0	4.764	165,0	6.496	70,0	1015.3	93,0	0,0	0,0	1,1	2.430	DC..11T3.. DC..32.5.
C6-SDJCL-45065-11JET	02603176	C6	-	63,0	2.480	45,0	1.772	65,0	2.559	121,0	4.764	165,0	6.496	70,0	1015.3	93,0	0,0	0,0	1,1	2.430	DC..11T3.. DC..32.5.

Spare Parts

For size	Inducer kit	Inducer screw	Insert/inducer key	Insert screw	Insert shim	O-ring	Shim screw
.R-11	JET-CIKD11RB-KIT	117.26-655	3SMS795/T15P	C03512-T15P	126.19-620	ORING-6.07X1.78	CA3510
.L-11	JET-CIKD11LB-KIT	117.26-655	3SMS795/T15P	C03512-T15P	126.19-620	ORING-6.07X1.78	CA3510

Accessories

For size	Insert clamping torque	Replacement blade	Shim key	Torque key
.R-11	3.0NM	T00-15P	9/64SMS875	T00-15P30
.L-11	3.0NM	T00-15P	9/64SMS875	T00-15P30

General ISO Turning Holders
Steadyline®
MDT
Mini-Shaft™
Grooving
Parting-off
X4
Adapters Clamping units
Accessories and Spare parts
Workpiece materials

C.-SRSCR/L...JET – Toolholders for inserts RCMT – Metric/ Inch

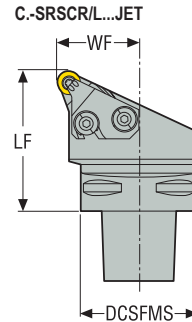
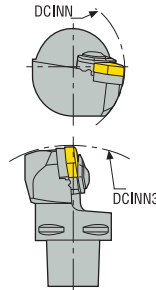

C.-SRSCR/L...JET
KAPR = 45,0 °

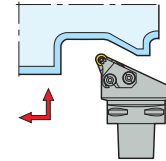

CTWS



- For inserts program, see page(s) 545, 546
- For more information on Jetstream Tooling® (High pressure coolant) and accessories, please see page(s) 38, 85-89, 1002
- GAMO° = Rake angle, LAMS° = Inclination angle
- CTMS = Seco-Capto™ size
- CTWS = Insert shape and size
- For holder code key, see page(s) 11-12
- * Max coolant pressure
- ** Jetstream Tooling® Duo, see page(s) 38, 85-89
- For JETI coolant clamp it is recommended to set regular screw and double O-rings exchange rate to keep the safety first and minimize leakage for the application at hand
- Right-hand version shown
- Please check availability at www.secotools.com / Seco Online Store

Designation	Item number	CTMS	**	DCSFMS		LF	DCINN	DCINN3	CP*	KAPR°	GAMO°	LAMS°	Weight	CTWS
				mm	Inch	mm	Inch	mm	mm					
C5-SRSCR-35060-12JET	02603183	C5	-	50,0	35,0	60,0	95,0	165,0	70,0	45,0	0,0	0,0	0,8	RC..1204..
				1.969	1.378	2.362	3.740	6.496	70.0				1.760	
C5-SRSCl-35060-12JET	02603184	C5	-	50,0	35,0	60,0	95,0	165,0	70,0	45,0	0,0	0,0	0,8	RC..1204..
				1.969	1.378	2.362	3.740	6.496	70.0				1.760	
C6-SRSCR-45065-12JET	02603187	C6	-	63,0	45,0	65,0	121,0	165,0	70,0	45,0	0,0	0,0	1,2	RC..1204..
				2.480	1.772	2.559	4.764	6.496	70.0				2.650	
C6-SRSCl-45065-12JET	02603188	C6	-	63,0	45,0	65,0	121,0	165,0	70,0	45,0	0,0	0,0	1,2	RC..1204..
				2.480	1.772	2.559	4.764	6.496	70.0				2.650	

Spare Parts

For size	Inducer kit	Inducer screw	Insert/inducer key	Insert screw	Insert shim	O-ring	Shim screw
...R-12	JET-CIKR00RB-KIT	117.26-655	3SMS795/T15P	C03510-T15P	111.19-621	ORING-6.07X1.78	CA3510
...L-12	JET-CIKR00LB-KIT	117.26-655	3SMS795/T15P	C03510-T15P	111.19-621	ORING-6.07X1.78	CA3510

Accessories

For size	Insert clamping torque	Replacement blade	Shim key	Torque key
...R-12	3.0NM	T00-15P	9/64SMS875	T00-15P30
...L-12	3.0NM	T00-15P	9/64SMS875	T00-15P30

C.-SVJBR/L...JET – Toolholders for inserts VBGT, VBGW, VBMT, VBMTW and VCGT – Metric / Inch

C.-SVJBR/L...JET
KAPR = 93,0°

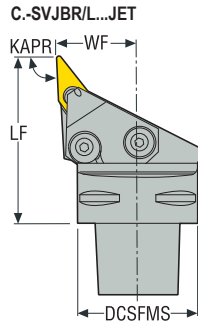
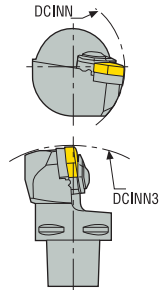
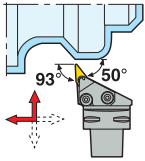

- For inserts program, see page(s) 563, 564, 564, 594, 602
- For more information on Jetstream Tooling® (High pressure coolant) and accessories, please see page(s) 38, 85-89, 1002
- GAMO° = Rake angle, LAMS° = Inclination angle
- CTMS = Seco-Capto™ size
- CTWS = Insert shape and size
- For holder code key, see page(s) 11-12
- * Max coolant pressure
- ** Jetstream Tooling® Duo, see page(s) 38, 85-89
- For JETI coolant clamp it is recommended to set regular screw and double O-rings exchange rate to keep the safety first and minimize leakage for the application at hand
- Right-hand version shown
- Please check availability at www.secotools.com / Seco Online Store

Designation	Item number	CTMS	**	DCSFMS		WF	LF	DCINN	DCINN3	CP*	KAPR°	GAMO°	LAMS°	Weight	CTWS						
				mm	Inch	mm	Inch	mm	Inch	mm	Inch	bar	psi			kg	lbs				
C4-SVJBR-27055-16JET	02603189	C4	-	40,0	1.575	27,0	1.063	55,0	2.165	75,0	2.953	165,0	6.496	70,0	1015.3	93,0	0,0	0,0	0,4	0.880	VB...VC..1604. VB...VC..33.
C4-SVJBL-27055-16JET	02603190	C4	-	40,0	1.575	27,0	1.063	55,0	2.165	75,0	2.953	165,0	6.496	70,0	1015.3	93,0	0,0	0,0	0,4	0.880	VB...VC..1604. VB...VC..33.
C5-SVJBR-35060-16JET	02603191	C5	-	50,0	1.969	35,0	1.378	60,0	2.362	95,0	3.740	165,0	6.496	70,0	1015.3	93,0	0,0	0,0	0,7	1.540	VB...VC..1604. VB...VC..33.
C5-SVJBL-35060-16JET	02603192	C5	-	50,0	1.969	35,0	1.378	60,0	2.362	95,0	3.740	165,0	6.496	70,0	1015.3	93,0	0,0	0,0	0,7	1.540	VB...VC..1604. VB...VC..33.
C6-SVJBR-45065-16JET	02603193	C6	-	63,0	2.480	45,0	1.772	65,0	2.559	121,0	4.764	165,0	6.496	70,0	1015.3	93,0	0,0	0,0	1,1	2.430	VB...VC..1604. VB...VC..33.
C6-SVJBL-45065-16JET	02603194	C6	-	63,0	2.480	45,0	1.772	65,0	2.559	121,0	4.764	165,0	6.496	70,0	1015.3	93,0	0,0	0,0	1,1	2.430	VB...VC..1604. VB...VC..33.

Spare Parts

For size	Inducer kit	Inducer screw	Insert/inducer key	Insert screw	Insert shim	O-ring	Shim screw
...R-16	JET-CIKV16RB-KIT	117.26-655	3SMS795/T15P	C03512-T15P	171.19-620	ORING-6.07X1.78	CA3510
...L-16	JET-CIKV16LB-KIT	117.26-655	3SMS795/T15P	C03512-T15P	171.19-620	ORING-6.07X1.78	CA3510

Accessories

For size	Insert clamping torque	Replacement blade	Shim key	Torque key
...R-16	3.0NM	T00-15P	9/64SMS875	T00-15P30
...L-16	3.0NM	T00-15P	9/64SMS875	T00-15P30

General ISO Turning Holders
Steadyline®
MDT
Mini-Shaft™
Grooving
Parting-off
X4
Adapters Clamping units
Accessories and Spare parts
Workpiece materials

C-DCKNR/L...-M – Toolholders for inserts CNGA, CNGG, CNMA, CNMG and CNMM – Metric/ Inch

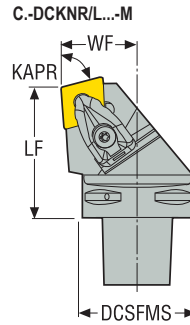
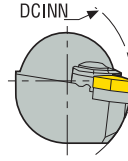

C-DCKNR/L, -M
KAPR = 75,0 °

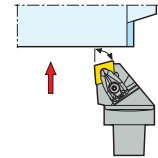









CTWS





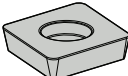

- For inserts program, see page(s) 527, 528, 529, 530, 531, 532, 533, 575, 576
- GAMO° = Rake angle, LAMS° = Inclination angle
- CTMS = Seco-Capto™ size
- CTWS = Insert shape and size
- For holder code key, see page(s) 11-12
- Shim DCN120416 for insert CN..1204.., to be ordered separately
- Right-hand version shown
- Please check availability at www.secotools.com / Seco Online Store

Designation	Item number	CTMS	DCSFMS	WF	LF	DCINN	DCINN3	KAPR°	GAMO°	LAMS°	Weight	CTWS
			mm Inch	mm Inch	mm Inch	mm Inch	mm Inch				kg lbs	
C4-DCKNR-27050-12-M	02587878	C4	40,0 1.575	27,0 1.063	50,0 1.969	110,0 4.331	110,0 4.331	75,0	-6,0	-6,0	0,5 1.100	CN..1204.. CN..43.
C4-DCKNL-27050-12-M	02587879	C4	40,0 1.575	27,0 1.063	50,0 1.969	110,0 4.331	110,0 4.331	75,0	-6,0	-6,0	0,5 1.100	CN..1204.. CN..43.
C5-DCKNR-35060-12-M	02587884	C5	50,0 1.969	35,0 1.378	60,0 2.362	110,0 4.331	110,0 4.331	75,0	-6,0	-6,0	0,9 1.980	CN..1204.. CN..43.
C5-DCKNL-35060-12-M	02587885	C5	50,0 1.969	35,0 1.378	60,0 2.362	110,0 4.331	110,0 4.331	75,0	-6,0	-6,0	0,9 1.980	CN..1204.. CN..43.
C5-DCKNR-35060-16-M	02587886	C5	50,0 1.969	35,0 1.378	60,0 2.362	125,0 4.921	125,0 4.921	75,0	-6,0	-6,0	0,9 1.980	CN..1606.. CN..54.
C5-DCKNL-35060-16-M	02587887	C5	50,0 1.969	35,0 1.378	60,0 2.362	125,0 4.921	125,0 4.921	75,0	-6,0	-6,0	0,9 1.980	CN..1606.. CN..54.
C5-DCKNR-35060-19-M	02587888	C5	50,0 1.969	35,0 1.378	60,0 2.362	95,0 3.740	95,0 3.740	75,0	-6,0	-6,0	0,8 1.760	CN..1906.. CN..64.
C5-DCKNL-35060-19-M	02587889	C5	50,0 1.969	35,0 1.378	60,0 2.362	95,0 3.740	95,0 3.740	75,0	-6,0	-6,0	0,8 1.760	CN..1906.. CN..64.
C6-DCKNR-45065-12-M	02587890	C6	63,0 2.480	45,0 1.772	65,0 2.559	110,0 4.331	110,0 4.331	75,0	-6,0	-6,0	1,4 3.090	CN..1204.. CN..43.
C6-DCKNL-45065-12-M	02587891	C6	63,0 2.480	45,0 1.772	65,0 2.559	110,0 4.331	110,0 4.331	75,0	-6,0	-6,0	1,4 3.090	CN..1204.. CN..43.
C6-DCKNR-45065-16-M	02587892	C6	63,0 2.480	45,0 1.772	65,0 2.559	125,0 4.921	125,0 4.921	75,0	-6,0	-6,0	1,4 3.090	CN..1606.. CN..54.
C6-DCKNL-45065-16-M	02587893	C6	63,0 2.480	45,0 1.772	65,0 2.559	125,0 4.921	125,0 4.921	75,0	-6,0	-6,0	1,4 3.090	CN..1606.. CN..54.

Spare Parts

For size	Clamp pin	Clamp screw	Coolant nozzle	Floating wedge clamp	Insert shim	Shim/clamp key	Shim screw	Spring
								
C4..-12	FP2012	L85021-T15P	CN6	CD12-S	DCN120616	T15P-2	C04008-T15P	S6912
C5..-12	FP2012	L85021-T15P	CN7	CD12-S	DCN120616	T15P-2	C04008-T15P	S6912
-16	FP2012	L86026-T20P	CN7	CD16-S	DCN160616	T20P-7L	C05010-T20P	S7010
-19	FP2012	L86026-T20P	CN6	CD19-S	DCN190416	T20P-7L	C05010-T20P	S7010
-12	FP2012	L85021-T15P	CN7	CD12-S	DCN120616	T15P-2	C04008-T15P	S6912

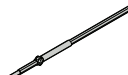
Accessories

For size	Clamp kit	Insert clamping torque	Replacement blade	Torque key
				
C4..-12	CD12-S12	3.5NM	T00-15P	T00-15P35
C5..-12	CD12-S12	3.5NM	T00-15P	T00-15P35
-16	CD16-S16	6.0NM	T00T-20P	T00T-20P60
-19	CD19-S19	6.0NM	T00T-20P	T00T-20P60
-12	CD12-S12	3.5NM	T00-15P	T00-15P35

General ISO Turning
Holders

Steadyline®

MDT

Mini-Shaft™

Grooving

Parting-off

X4

Adapters
Clamping units

Accessories and
Spare parts

Workpiece
materials

C.-DCLNR/L...-M and C.-DCLNR/L – Toolholders for inserts CNGA, CNGG, CNMA, CNMG and CNMM – Metric/ Inch

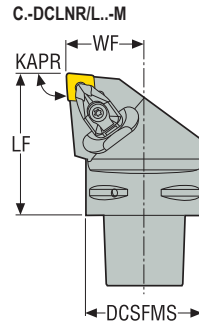
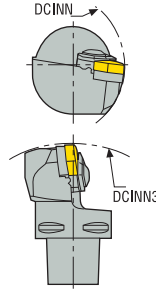

CTWS













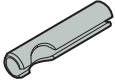

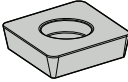





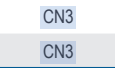

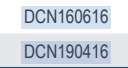



- For inserts program, see page(s) 527, 528, 529, 530, 531, 532, 533, 575, 576
- GAMO° = Rake angle, LAMS° = Inclination angle
- CTMS = Seco-Capto™ size
- CTWS = Insert shape and size
- For holder code key, see page(s) 11-12
- Shim DCN120416 for insert CN..1204.., to be ordered separately
- Right-hand version shown
- Please check availability at www.secotools.com / Seco Online Store



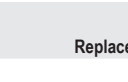







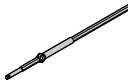

Designation	Item number	CTMS	DCSFMS		LF	DCINN	DCINN3	KAPR°	GAMO°	LAMS°	Weight	CTWS
			mm	mm								
			Inch	Inch	Inch	Inch	Inch				kg	
											lbs	
C4-DCLNR-27050-12-M	02587838	C4	40,0	27,0	50,0	110,0	140,0	95,0	-6,0	-6,0	0,4	CN..1204.. CN..43.
			1.575	1.063	1.969	4.331	5.512				0.880	
C4-DCLNL-27050-12-M	02587839	C4	40,0	27,0	50,0	110,0	140,0	95,0	-6,0	-6,0	0,4	CN..1204.. CN..43.
			1.575	1.063	1.969	4.331	5.512				0.880	
C4-DCLNR-27055-16-M	02587840	C4	40,0	27,0	55,0	125,0	155,0	95,0	-6,0	-6,0	0,5	CN..1606.. CN..54.
			1.575	1.063	2.165	4.921	6.102				1.100	
C4-DCLNL-27055-16-M	02587841	C4	40,0	27,0	55,0	125,0	155,0	95,0	-6,0	-6,0	0,5	CN..1606.. CN..54.
			1.575	1.063	2.165	4.921	6.102				1.100	
C5-DCLNR-35060-12-M	02587844	C5	50,0	35,0	60,0	110,0	165,0	95,0	-6,0	-6,0	0,8	CN..1204.. CN..43.
			1.969	1.378	2.362	4.331	6.496				1.760	
C5-DCLNL-35060-12-M	02587845	C5	50,0	35,0	60,0	110,0	165,0	95,0	-6,0	-6,0	0,8	CN..1204.. CN..43.
			1.969	1.378	2.362	4.331	6.496				1.760	
C5-DCLNR-35060-16-M	02587846	C5	50,0	35,0	60,0	125,0	165,0	95,0	-6,0	-6,0	0,8	CN..1606.. CN..54.
			1.969	1.378	2.362	4.921	6.496				1.760	
C5-DCLNL-35060-16-M	02587847	C5	50,0	35,0	60,0	125,0	165,0	95,0	-6,0	-6,0	0,8	CN..1606.. CN..54.
			1.969	1.378	2.362	4.921	6.496				1.760	
C5-DCLNR-35060-19-M	02587848	C5	50,0	35,0	60,0	80,0	165,0	95,0	-6,0	-6,0	0,8	CN..1906.. CN..64.
			1.969	1.378	2.362	3.150	6.496				1.760	
C5-DCLNL-35060-19-M	02587849	C5	50,0	35,0	60,0	80,0	165,0	95,0	-6,0	-6,0	0,8	CN..1906.. CN..64.
			1.969	1.378	2.362	3.150	6.496				1.760	
C6-DCLNR-45065-12-M	02587850	C6	63,0	45,0	65,0	110,0	190,0	95,0	-6,0	-6,0	1,3	CN..1204.. CN..43.
			2.480	1.772	2.559	4.331	7.480				2.870	
C6-DCLNL-45065-12-M	02587851	C6	63,0	45,0	65,0	110,0	190,0	95,0	-6,0	-6,0	1,3	CN..1204.. CN..43.
			2.480	1.772	2.559	4.331	7.480				2.870	
C6-DCLNR-45065-16-M	02587852	C6	63,0	45,0	65,0	125,0	190,0	95,0	-6,0	-6,0	1,3	CN..1606.. CN..54.
			2.480	1.772	2.559	4.921	7.480				2.870	
C6-DCLNL-45065-16-M	02587853	C6	63,0	45,0	65,0	125,0	190,0	95,0	-6,0	-6,0	1,3	CN..1606.. CN..54.
			2.480	1.772	2.559	4.921	7.480				2.870	
C6-DCLNR-45065-19-M	02587854	C6	63,0	45,0	65,0	81,0	190,0	95,0	-6,0	-6,0	1,3	CN..1906.. CN..64.
			2.480	1.772	2.559	3.189	7.480				2.870	
C6-DCLNL-45065-19-M	02587855	C6	63,0	45,0	65,0	81,0	190,0	95,0	-6,0	-6,0	1,3	CN..1906.. CN..64.
			2.480	1.772	2.559	3.189	7.480				2.870	
C8-DCLNR-55080-16	02417033	C8	80,0	55,0	80,0	125,0	150,0	95,0	-6,0	-6,0	2,5	CN..1606.. CN..54.
			3.150	2.165	3.150	4.921	5.906				5.510	
C8-DCLNL-55080-16	02417031	C8	80,0	55,0	80,0	125,0	150,0	95,0	-6,0	-6,0	2,5	CN..1606.. CN..54.
			3.150	2.165	3.150	4.921	5.906				5.510	

Designation	Item number	CTMS	DCSFMS	WF	LF	DCINN	DCINN3	KAPR°	GAMO°	LAMS°	Weight	CTWS
			mm Inch	mm Inch	mm Inch	mm Inch	mm Inch					
C8-DCLNR-55080-19	00024776	C8	80,0 3.150	55,0 2.165	80,0 3.150	100,0 3.937	250,0 9.843	95,0	-6,0	-6,0	2,5 5.510	CN..1906.. CN..64.
C8-DCLNL-55080-19	02417036	C8	80,0 3.150	55,0 2.165	80,0 3.150	100,0 3.937	250,0 9.843	95,0	-6,0	-6,0	2,5 5.510	CN..1906.. CN..64.

Spare Parts

For size	Clamp pin	Clamp screw	Coolant nozzle	Floating wedge clamp	Insert shim	Shim/clamp key	Shim screw	Spring
-12	 FP2012	 L85021-T15P	 CN3	 CD12-S	 DCN120616	 T15P-2	 C04008-T15P	 S6912
-16	 FP2012	 L86026-T20P	 CN3	 CD16-S	 DCN160616	 T20P-7L	 C05010-T20P	 S7010
-19	 FP2012	 L86026-T20P	 CN3	 CD19-S	 DCN190416	 T20P-7L	 C05010-T20P	 S7010

Accessories

For size	Clamp kit	Insert clamping torque	Replacement blade	Torque key
-12	 CD12-S12	 3.5NM	 T00-15P	 T00-15P35
-16	 CD16-S16	 6.0NM	 T00T-20P	 T00T-20P60
-19	 CD19-S19	 6.0NM	 T00T-20P	 T00T-20P60

General ISO Turning
Holders

Steadyline®

MDT

Mini-Shaft™

Grooving

Parting-off

X4

Adapters
Clamping units

Accessories and
Spare parts

Workpiece
materials

C-DICRNR/L...-M and C-DICRNR/L – Toolholders for inserts CNGA, CNGG, CNMA, CNMG and CNMM – Metric / Inch

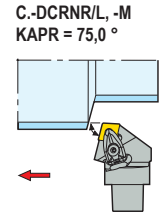
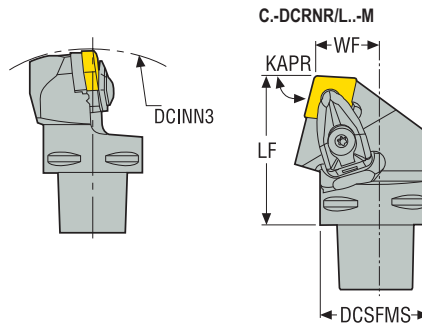









CTWS





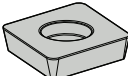

- For inserts program, see page(s) 527, 528, 529, 530, 531, 532, 533, 575, 576
- GAMO° = Rake angle, LAMS° = Inclination angle
- CTMS = Seco-Capto™ size
- CTWS = Insert shape and size
- For holder code key, see page(s) 11-12
- Shim DCN120416 for insert CN..1206.., to be ordered separately
- Right-hand version shown
- Please check availability at www.secotools.com / Seco Online Store

Designation	Item number	CTMS	DCSFMS	WF	LF	DCINN	DCINN3	KAPR°	GAMO°	LAMS°	Weight	CTWS
			mm Inch	mm Inch	mm Inch	mm Inch	mm Inch				kg lbs	
C4-DICRNR-22050-12-M	02587858	C4	40,0 1.575	22,0 0.866	50,0 1.969	140,0 5.512	140,0 5.512	75,0	-6,0	-6,0	0,4 0.880	CN..1204.. CN..43.
C4-DICRNL-22050-12-M	02587859	C4	40,0 1.575	22,0 0.866	50,0 1.969	140,0 5.512	140,0 5.512	75,0	-6,0	-6,0	0,4 0.880	CN..1204.. CN..43.
C4-DICRNR-22055-16-M	02587860	C4	40,0 1.575	22,0 0.866	55,0 2.165	165,0 6.496	165,0 6.496	75,0	-6,0	-6,0	0,5 1.100	CN..1606.. CN..54.
C4-DICRNL-22055-16-M	02587861	C4	40,0 1.575	22,0 0.866	55,0 2.165	165,0 6.496	165,0 6.496	75,0	-6,0	-6,0	0,5 1.100	CN..1606.. CN..54.
C5-DICRNR-27060-12-M	02587864	C5	50,0 1.969	27,0 1.063	60,0 2.362	165,0 6.496	165,0 6.496	75,0	-6,0	-6,0	0,8 1.760	CN..1204.. CN..43.
C5-DICRNL-27060-12-M	02587865	C5	50,0 1.969	27,0 1.063	60,0 2.362	165,0 6.496	165,0 6.496	75,0	-6,0	-6,0	0,8 1.760	CN..1204.. CN..43.
C5-DICRNR-27060-16-M	02587866	C5	50,0 1.969	27,0 1.063	60,0 2.362	165,0 6.496	165,0 6.496	75,0	-6,0	-6,0	0,8 1.760	CN..1606.. CN..54.
C5-DICRNL-27060-16-M	02587867	C5	50,0 1.969	27,0 1.063	60,0 2.362	165,0 6.496	165,0 6.496	75,0	-6,0	-6,0	0,8 1.760	CN..1606.. CN..54.
C6-DICRNR-35065-12-M	02587870	C6	63,0 2.480	35,0 1.378	65,0 2.559	190,0 7.480	190,0 7.480	75,0	-6,0	-6,0	1,2 2.650	CN..1204.. CN..43.
C6-DICRNL-35065-12-M	02587871	C6	63,0 2.480	35,0 1.378	65,0 2.559	190,0 7.480	190,0 7.480	75,0	-6,0	-6,0	1,2 2.650	CN..1204.. CN..43.
C6-DICRNR-35065-16-M	02587872	C6	63,0 2.480	35,0 1.378	65,0 2.559	190,0 7.480	190,0 7.480	75,0	-6,0	-6,0	1,3 2.870	CN..1606.. CN..54.
C6-DICRNL-35065-16-M	02587873	C6	63,0 2.480	35,0 1.378	65,0 2.559	190,0 7.480	190,0 7.480	75,0	-6,0	-6,0	1,3 2.870	CN..1606.. CN..54.
C6-DICRNR-35065-19-M	02587874	C6	63,0 2.480	35,0 1.378	65,0 2.559	190,0 7.480	190,0 7.480	75,0	-6,0	-6,0	1,3 2.870	CN..1906.. CN..64.
C6-DICRNL-35065-19-M	02587875	C6	63,0 2.480	35,0 1.378	65,0 2.559	190,0 7.480	190,0 7.480	75,0	-6,0	-6,0	1,3 2.870	CN..1906.. CN..64.
C8-DICRNR-55080-19	00024777	C8	80,0 3.150	55,0 2.165	80,0 3.150	250,0 9.843	250,0 9.843	75,0	-6,0	-6,0	2,6 5.730	CN..1906.. CN..64.
C8-DICRNL-55080-19	02546532	C8	80,0 3.150	55,0 2.165	80,0 3.150	250,0 9.843	250,0 9.843	75,0	-6,0	-6,0	2,6 5.730	CN..1906.. CN..64.

Spare Parts

For size	Clamp pin	Clamp screw	Coolant nozzle	Floating wedge clamp	Insert shim	Shim/clamp key	Shim screw	Spring
								
C4..-12	FP2012	L85021-T15P	CN6	CD12-S	DCN120616	T15P-2	C04008-T15P	S6912
C4..-16	FP2012	L86026-T20P	CN6	CD16-S	DCN160616	T20P-7L	C05010-T20P	S7010
C5, C6..-12	FP2012	L85021-T15P	CN3	CD12-S	DCN120616	T15P-2	C04008-T15P	S6912
C5, C6..-16	FP2012	L86026-T20P	CN3	CD16-S	DCN160616	T20P-7L	C05010-T20P	S7010
-19	FP2012	L86026-T20P	CN3	CD19-S	DCN190416	T20P-7L	C05010-T20P	S7010

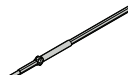
Accessories

For size	Clamp kit	Insert clamping torque	Replacement blade	Torque key
				
C4..-12	CD12-S12	3.5NM	T00-15P	T00-15P35
C4..-16	CD16-S16	6.0NM	T00T-20P	T00T-20P60
C5, C6..-12	CD12-S12	3.5NM	T00-15P	T00-15P35
C5, C6..-16	CD16-S16	6.0NM	T00T-20P	T00T-20P60
-19	CD19-S19	6.0NM	T00T-20P	T00T-20P60

General ISO Turning
Holders

Steadyline®

MDT

Mini-Shaft™

Grooving

Parting-off

X4

Adapters
Clamping units

Accessories and
Spare parts

Workpiece
materials

C-DDJNR/L...-M and C-DDJNR/L – Toolholders for inserts DNGA, DNGG, DNGM, DNMA, DNMG, DNMM and DNMX – Metric/ Inch

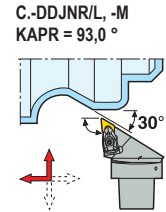
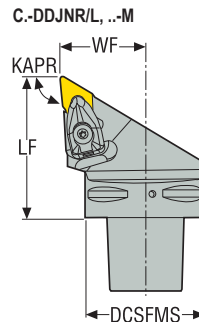
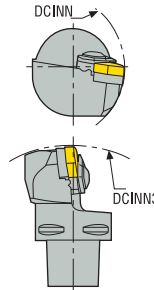





















































CTWS



















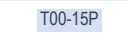



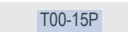



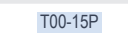

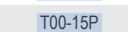

- For inserts program, see page(s) 537, 538, 539, 540, 541, 579, 580, 598
- GAMO° = Rake angle, LAMS° = Inclination angle
- CTMS = Seco-Capto™ size
- CTWS = Insert shape and size
- For holder code key, see page(s) 11-12
- Shim DDN150616 for insert DN..1504.., to be ordered separately
- Right-hand version shown
- * Use the right shim & the right screw for the selected insert. For details, see page 99
- Please check availability at www.secotools.com / Seco Online Store

Designation	Item number	CTMS	DCSFMS		LF	DCINN		KAPR°	GAMO°	LAMS°	Weight	CTWS
			mm Inch	mm Inch		mm Inch	mm Inch					
C4-DDJNR-27050-11-M	02587896	C4	40,0 1.575	27,0 1.063	50,0 1.969	60,0 2.362	140,0 5.512	93,0	-6,0	-7,0	0,4 0.880	DN..1104.. DN..33.
C4-DDJNL-27050-11-M	02587897	C4	40,0 1.575	27,0 1.063	50,0 1.969	60,0 2.362	140,0 5.512	93,0	-6,0	-7,0	0,4 0.880	DN..1104.. DN..33.
C4-DDJNR-27055-15-M	02587902	C4	40,0 1.575	27,0 1.063	55,0 2.165	110,0 4.331	145,0 5.709	93,0	-6,0	-7,0	0,4 0.880	DN.1504/DN..1506 DN..43/DN..44*
C4-DDJNL-27055-15-M	02587903	C4	40,0 1.575	27,0 1.063	55,0 2.165	110,0 4.331	145,0 5.709	93,0	-6,0	-7,0	0,4 0.880	DN.1504/DN..1506 DN..43/DN..44*
C5-DDJNR-35060-11-M	02587898	C5	50,0 1.969	35,0 1.378	60,0 2.362	65,0 2.559	165,0 6.496	93,0	-6,0	-7,0	0,7 1.540	DN..1104.. DN..33.
C5-DDJNL-35060-11-M	02587899	C5	50,0 1.969	35,0 1.378	60,0 2.362	65,0 2.559	165,0 6.496	93,0	-6,0	-7,0	0,7 1.540	DN..1104.. DN..33.
C5-DDJNR-35060-15-M	02587904	C5	50,0 1.969	35,0 1.378	60,0 2.362	110,0 4.331	165,0 6.496	93,0	-6,0	-7,0	0,7 1.540	DN.1504/DN..1506 DN..43/DN..44*
C5-DDJNL-35060-15-M	02587905	C5	50,0 1.969	35,0 1.378	60,0 2.362	110,0 4.331	165,0 6.496	93,0	-6,0	-7,0	0,7 1.540	DN.1504/DN..1506 DN..43/DN..44*
C6-DDJNR-45065-11-M	02587900	C6	63,0 2.480	45,0 1.772	65,0 2.559	81,0 3.189	190,0 7.480	93,0	-6,0	-7,0	1,1 2.430	DN..1104.. DN..33.
C6-DDJNL-45065-11-M	02587901	C6	63,0 2.480	45,0 1.772	65,0 2.559	81,0 3.189	190,0 7.480	93,0	-6,0	-7,0	1,1 2.430	DN..1104.. DN..33.
C6-DDJNR-45065-15-M	02587906	C6	63,0 2.480	45,0 1.772	65,0 2.559	110,0 4.331	190,0 7.480	93,0	-6,0	-7,0	1,1 2.430	DN.1504/DN..1506 DN..43/DN..44*
C6-DDJNL-45065-15-M	02587907	C6	63,0 2.480	45,0 1.772	65,0 2.559	110,0 4.331	190,0 7.480	93,0	-6,0	-7,0	1,1 2.430	DN.1504/DN..1506 DN..43/DN..44*
C8-DDJNR-55080-15	02417037	C8	80,0 3.150	55,0 2.165	80,0 3.150	110,0 4.331	250,0 9.843	93,0	-6,0	-7,0	2,2 4.850	DN.1504/DN..1506 DN..43/DN..44*
C8-DDJNR-55080-15-04	02642325	C8	80,0 3.150	55,0 2.165	80,0 3.150	110,0 4.331	250,0 9.843	93,0	-6,0	-7,0	2,4 5.290	DN.1504/DN..1506 DN..43/DN..44*
C8-DDJNL-55080-15	02417038	C8	80,0 3.150	55,0 2.165	80,0 3.150	110,0 4.331	250,0 9.843	93,0	-6,0	-7,0	2,2 4.850	DN.1504/DN..1506 DN..43/DN..44*
C8-DDJNL-55080-15-04	02642326	C8	80,0 3.150	55,0 2.165	80,0 3.150	110,0 4.331	250,0 9.843	93,0	-6,0	-7,0	2,4 5.290	DN.1504/DN..1506 DN..43/DN..44*

Spare Parts

For size	Clamp pin	Clamp screw	Coolant nozzle	Floating wedge clamp	Insert shim	Shim/clamp key	Shim screw	Spring
..-11	 FP1508	 L84017-T09P	 CN6	 CD09-S	 DDN110310	 T09P-2	 C03007-T09P	 S5608
C4..-15	 FP2012	 L85021-T15P	 CN6	 CD12-S	 DDN150416	 T15P-2	 C04008-T15P	 S6912
C5..-15	 FP2012	 L85021-T15P	 CN3	 CD12-S	 DDN150416	 T15P-2	 C04008-T15P	 S6912
C6..-15	 FP2012	 L85021-T15P	 CN7	 CD12-S	 DDN150416	 T15P-2	 C04008-T15P	 S6912
C8..-15	 FP2012	 L85021-T15P	 CN8	 CD12-S	 DDN150416	 T15P-2	 C04008-T15P	 S6912
C8..R-15-04	 FP2012	 L85021-T15P	-	 CD12-S	 DDN150616	 T15P-2	-	 S6912
C8..L-15-04	 FP2012	 L85021-T15P	-	 CD12-S	 DDN150616	 T15P-2	 C04008-T15P	 S6912

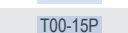
Accessories

For size	Clamp kit	Insert clamping torque	Replacement blade	Torque key
..-11	 CD09-S09	 2.0NM	 T00-09P	 T00-09P20
C4..-15	 CD12-S12	 3.5NM	 T00-15P	 T00-15P35
C5..-15	 CD12-S12	 3.5NM	 T00-15P	 T00-15P35
C6..-15	 CD12-S12	 3.5NM	 T00-15P	 T00-15P35
C8..-15	 CD12-S12	 3.5NM	 T00-15P	 T00-15P35
C8..R-15-04	 CD12-S12	 3.5NM	 T00-15P	 T00-15P35
C8..L-15-04	 CD12-S12	 3.5NM	 T00-15P	 T00-15P35

General ISO Turning
Holders

Steadyline®

MDT

Mini-Shaft™

Grooving

Parting-off

X4

Adapters
Clamping units

Accessories and
Spare parts

Workpiece
materials

C-DDNNN...-M – Toolholders for inserts DNGA, DNGG, DNGM, DNMA, DNMG and DNMM – Metric/ Inch

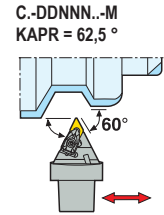
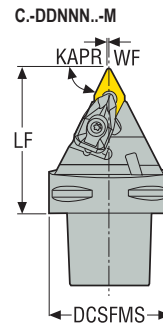
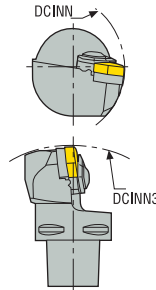

- For inserts program, see page(s) 537, 538, 539, 540, 541, 579, 580, 598
- GAMO° = Rake angle, LAMS° = Inclination angle
- CTMS = Seco-Capto™ size
- CTWS = Insert shape and size
- For holder code key, see page(s) 11-12
- Neutral version shown
- * Use the right shim & the right screw for the selected insert. For details, see page 99
- Please check availability at www.secotools.com / Seco Online Store

Designation	Item number	CTMS	DCSFMS	WF	LF	DCINN	DCINN3	KAPR°	GAMO°	LAMS°	Weight	CTWS
			mm Inch	mm Inch	mm Inch	mm Inch	mm Inch				kg lbs	
C4-DDNNN-00050-11-M	02587914	C4	40,0 1.575	0,5 0.020	50,0 1.969	-	140,0 5.512	62,5	-5,0	-9,0	0,4 0.880	DN..1104.. DN..33.
C4-DDNNN-00055-15-M	02587917	C4	40,0 1.575	0,5 0.020	55,0 2.165	-	145,0 5.709	62,5	-5,0	-9,0	0,4 0.880	DN.1504/DN..1506 DN..43/DN..44*
C5-DDNNN-00060-15-M	02587918	C5	50,0 1.969	0,5 0.020	60,0 2.362	-	165,0 6.496	62,5	-5,0	-9,0	0,6 1.320	DN.1504/DN..1506 DN..43/DN..44*
C6-DDNNN-00065-11-M	02587916	C6	63,0 2.480	0,5 0.020	65,0 2.559	-	190,0 7.480	62,5	-5,0	-9,0	1,0 2.200	DN..1104.. DN..33.
C6-DDNNN-00065-15-M	02587919	C6	63,0 2.480	0,5 0.020	65,0 2.559	-	190,0 7.480	62,5	-5,0	-9,0	1,0 2.200	DN.1504/DN..1506 DN..43/DN..44*

Spare Parts

For size	Clamp pin	Clamp screw	Coolant nozzle	Floating wedge clamp	Insert shim	Shim/clamp key	Shim screw	Spring
-11	FP1508	L84017-T09P	CN6	CD09-S	DDN110310	T09P-2	C03007-T09P	S5608
C4...15	FP2012	L85021-T15P	CN6	CD12-S	DDN150416	T15P-2	C04008-T15P	S6912
C5, C6...15	FP2012	L85021-T15P	CN3	CD12-S	DDN150416	T15P-2	C04008-T15P	S6912

Accessories

For size	Clamp kit	Insert clamping torque	Replacement blade	Torque key
-11	CD09-S09	2.0NM	T00-09P	T00-09P20
C4...15	CD12-S12	3.5NM	T00-15P	T00-15P35
C5, C6...15	CD12-S12	3.5NM	T00-15P	T00-15P35

General ISO Turning Holders
Steadyline®
MDT
Mini-Shaft™
Grooving
Parting-off
X4
Adapters Clamping units
Accessories and Spare parts
Workpiece materials

C.-DDUNR/L – Toolholders for inserts DNGA, DNGG, DNGM, DNMA, DNMG, DNMM and DNMX – Metric/ Inch

C.-DDUNR/L
KAPR = 93,0°

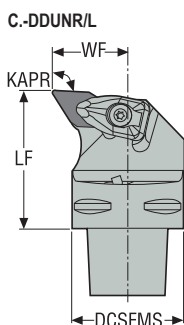
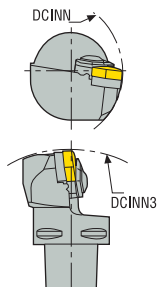
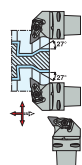

- For inserts program, see page(s) 537, 538, 539, 540, 541, 579, 580, 598
- GAMO° = Rake angle, LAMS° = Inclination angle
- CTMS = Seco-Capto™ size
- CTWS = Insert shape and size
- For holder code key, see page(s) 11-12
- Right-hand version shown
- * Use the right shim & the right screw for the selected insert. For details, see page 99
- Please check availability at www.secotools.com / Seco Online Store

Designation	Item number	CTMS	DCSFMS	WF	LF	DCINN	DCINN3	KAPR°	GAMO°	LAMS°	Weight	CTWS
C4-DDUNR-27050-15	02611291	C4	40,0 1.575	27,0 1.063	50,0 1.969	110,0 4.331	140,0 5.512	93,0	-6,0	-7,0	0,5 1.100	DN.1504/DN..1506 DN..43/DN..44*
C4-DDUNR-27050-15-04	02640737	C4	40,0 1.575	27,0 1.063	50,0 1.969	110,0 4.331	140,0 5.512	93,0	-6,0	-7,0	0,4 0.880	DN.1504/DN..1506 DN..43/DN..44*
C4-DDUNL-27050-15	02631210	C4	40,0 1.575	27,0 1.063	50,0 1.969	110,0 4.331	140,0 5.512	93,0	-6,0	-7,0	0,5 1.100	DN.1504/DN..1506 DN..43/DN..44*
C4-DDUNL-27050-15-04	02640738	C4	40,0 1.575	27,0 1.063	50,0 1.969	110,0 4.331	140,0 5.512	93,0	-6,0	-7,0	0,4 0.880	DN.1504/DN..1506 DN..43/DN..44*
C5-DDUNR-35060-15	02611233	C5	50,0 1.969	35,0 1.378	60,0 2.362	110,0 4.331	165,0 6.496	93,0	-6,0	-7,0	0,8 1.760	DN.1504/DN..1506 DN..43/DN..44*
C5-DDUNL-35060-15	02510294	C5	50,0 1.969	35,0 1.378	60,0 2.362	110,0 4.331	165,0 6.496	93,0	-6,0	-7,0	0,8 1.760	DN.1504/DN..1506 DN..43/DN..44*
C6-DDUNR-45065-15	02506920	C6	63,0 2.480	45,0 1.772	65,0 2.559	110,0 4.331	190,0 7.480	93,0	-6,0	-7,0	1,3 2.870	DN.1504/DN..1506 DN..43/DN..44*
C6-DDUNR-45065-15-04	02640744	C6	63,0 2.480	45,0 1.772	65,0 2.559	110,0 4.331	190,0 7.480	93,0	-6,0	-7,0	1,3 2.870	DN.1504/DN..1506 DN..43/DN..44*
C6-DDUNL-45065-15	02540058	C6	63,0 2.480	45,0 1.772	65,0 2.559	110,0 4.331	190,0 7.480	93,0	-6,0	-7,0	1,3 2.870	DN.1504/DN..1506 DN..43/DN..44*
C6-DDUNL-45065-15-04	02640745	C6	63,0 2.480	45,0 1.772	65,0 2.559	110,0 4.331	190,0 7.480	93,0	-6,0	-7,0	1,3 2.870	DN.1504/DN..1506 DN..43/DN..44*
C8-DDUNR-55080-15	02578445	C8	80,0 3.150	55,0 2.165	80,0 3.150	110,0 4.331	250,0 9.843	93,0	-6,0	-7,0	2,6 5.730	DN.1504/DN..1506 DN..43/DN..44*
C8-DDUNR-55080-15-04	02640746	C8	80,0 3.150	55,0 2.165	80,0 3.150	110,0 4.331	250,0 9.843	93,0	-6,0	-7,0	2,6 5.730	DN.1504/DN..1506 DN..43/DN..44*
C8-DDUNL-55080-15	02599256	C8	80,0 3.150	55,0 2.165	80,0 3.150	110,0 4.331	250,0 9.843	93,0	-6,0	-7,0	2,6 5.730	DN.1504/DN..1506 DN..43/DN..44*
C8-DDUNL-55080-15-04	02640749	C8	80,0 3.150	55,0 2.165	80,0 3.150	110,0 4.331	250,0 9.843	93,0	-6,0	-7,0	2,6 5.730	DN.1504/DN..1506 DN..43/DN..44*

General ISO Turning
Holders

Steadyline®

MDT

Mini-Shaft™

Grooving

Parting-off

X4

Adapters
Clamping units

Accessories and
Spare parts

Workpiece
materials

Spare Parts

For size	Clamp pin	Clamp screw	Coolant nozzle	Floating wedge clamp	Insert shim	Shim/clamp key	Shim screw	Spring
C4	FP2012	L85021-T15P	CN7	CD12-S	DDN150416	T15P-2	C04008-T15P	S6912
C4-04	FP2012	L85021-T15P	CN7	CD12-S	DDN150616	T15P-2	C04008-T15P	S6912
C5	FP2012	L85021-T15P	CN7	CD12-S	DDN150416	T15P-2	C04008-T15P	S6912
C6	FP2012	L85021-T15P	CN8	CD12-S	DDN150416	T15P-2	C04008-T15P	S6912
C6-04	FP2012	L85021-T15P	CN8	CD12-S	DDN150616	T15P-2	C04008-T15P	S6912
C8	FP2012	L85021-T15P	CN8	CD12-S	DDN150416	T15P-2	C04008-T15P	S6912
C8-04	FP2012	L85021-T15P	CN8	CD12-S	DDN150616	T15P-2	C04008-T15P	S6912

Accessories

For size	Clamp kit	Insert clamping torque	Replacement blade	Torque key
C4	CD12-S12	3.5NM	T00-15P	T00-15P35
C4-04	CD12-S12	3.5NM	T00-15P	T00-15P35
C5	CD12-S12	3.5NM	T00-15P	T00-15P35
C6	CD12-S12	3.5NM	T00-15P	T00-15P35
C6-04	CD12-S12	3.5NM	T00-15P	T00-15P35
C8	CD12-S12	3.5NM	T00-15P	T00-15P35
C8-04	CD12-S12	3.5NM	T00-15P	T00-15P35

General ISO Turning Holders
Steadyline®
MDT
Mini-Shaft™
Grooving
Parting-off
X4
Adapters Clamping units
Accessories and Spare parts
Workpiece materials

C.-DRSNR/L...-M – Toolholders for inserts RNMA and RNMG – Metric / Inch

C.-DRSNR/L...-M
KAPR = 45,0°

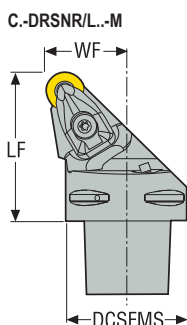
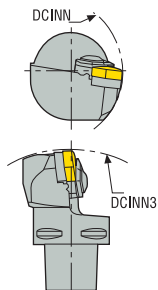
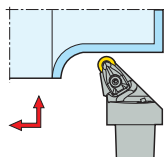

CTWS



- For inserts program, see page(s) 547
- GAMO° = Rake angle, LAMS° = Inclination angle
- CTMS = Seco-Capto™ size
- CTWS = Insert shape and size
- For holder code key, see page(s) 11-12
- Right-hand version shown
- Please check availability at www.secotools.com / Seco Online Store

Designation	Item number	CTMS	DCSFMS	WF	LF	DCINN	DCINN3	KAPR°	GAMO°	LAMS°	Weight	CTWS
C4-DRSNR-27050-12-M	02587923	C4	40,0 1.575	27,0 1.063	50,0 1.969	110,0 4.331	140,0 5.512	45,0	-6,0	-6,0	0,4 0.880	RN..1204.. RNM.43.
C4-DRSNL-27050-12-M	02587924	C4	40,0 1.575	27,0 1.063	50,0 1.969	110,0 4.331	140,0 5.512	45,0	-6,0	-6,0	0,4 0.880	RN..1204.. RNM.43.
C6-DRSNR-45065-19-M	02587931	C6	63,0 2.480	45,0 1.772	65,0 2.559	121,0 4.764	165,0 6.496	45,0	-6,0	-6,0	1,3 2.870	RN..1906.. RNM.64.
C6-DRSNL-45065-19-M	02587932	C6	63,0 2.480	45,0 1.772	65,0 2.559	121,0 4.764	165,0 6.496	45,0	-6,0	-6,0	1,3 2.870	RN..1906.. RNM.64.

Spare Parts

For size	Clamp pin	Clamp screw	Coolant nozzle	Floating wedge clamp	Insert shim	Shim/clamp key	Shim screw	Spring
C4..-12	FP2012	L85021-T15P	CN6	CD12-S	DRN120600	T15P-2	C04008-T15P	S6912
-19	FP2012	L86026-T20P	CN6	CD19-S	DRN190600	T20P-7L	C05010-T20P	S7010

Accessories

For size	Clamp kit	Insert clamping torque	Replacement blade	Torque key
C4..-12	CD12-S12	3.5NM	T00-15P	T00-15P35
-19	CD19-S19	6.0NM	T00T-20P	T00T-20P60

General ISO Turning
Holders

Steadyline®

MDT

Mini-Shaft™

Grooving

Parting-off

X4

Adapters
Clamping units

Accessories and
Spare parts

Workpiece
materials

C.-DSDNN...-M – Toolholders for inserts SNGA, SNMA, SNMG and SNMM – Metric/ Inch

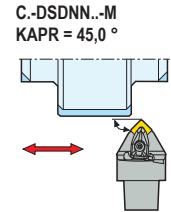
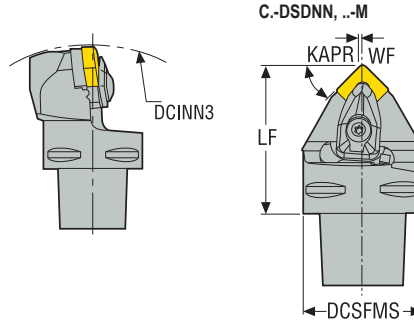

CTWS



- For inserts program, see page(s) 550, 551, 552, 553, 585
- GAMO° = Rake angle, LAMS° = Inclination angle
- CTMS = Seco-Capto™ size
- CTWS = Insert shape and size
- For holder code key, see page(s) 11-12
- Shim DSN120416 for insert SN..1206..., to be ordered separately
- Shim DSN190640 for insert SN..190624..., to be ordered separately
- Shim DSN250424 for insert SN..2509..., to be ordered separately
- Neutral version shown
- Please check availability at www.secotools.com / Seco Online Store





Designation	Item number	CTMS	DCSFMS		LF	DCINN	DCINN3	KAPR°	GAMO°	LAMS°	Weight	CTWS
			mm Inch	mm Inch								
C4-DSDNN-00050-09-M	02587973	C4	40,0 1.575	0,3 0.012	50,0 1.969	165,0 6.496	165,0 6.496	45,0	-6,0	-6,0	0,4 0.880	SN..0903.. SN..32.
C4-DSDNN-00055-15-M	02587975	C4	40,0 1.575	0,5 0.020	55,0 2.165	165,0 6.496	165,0 6.496	45,0	-6,0	-6,0	0,5 1.100	SN..1506.. SN..54.
C5-DSDNN-00060-12-M	02587977	C5	50,0 1.969	0,3 0.012	60,0 2.362	165,0 6.496	165,0 6.496	45,0	-6,0	-6,0	0,7 1.540	SN..1204.. SN..43.
C5-DSDNN-00060-15-M	02587978	C5	50,0 1.969	0,5 0.020	60,0 2.362	165,0 6.496	165,0 6.496	45,0	-6,0	-6,0	0,7 1.540	SN..1506.. SN..54.
C6-DSDNN-00065-12-M	02587980	C6	63,0 2.480	0,3 0.012	65,0 2.559	190,0 7.480	190,0 7.480	45,0	-6,0	-6,0	1,5 3.310	SN..1204.. SN..43.
C6-DSDNN-00070-19-M	02587982	C6	63,0 2.480	0,5 0.020	70,0 2.756	195,0 7.677	195,0 7.677	45,0	-6,0	-6,0	1,2 2.650	SN..1906.. SN..64.

Spare Parts

For size	Clamp pin	Clamp screw	Coolant nozzle	Floating wedge clamp	Insert shim	Shim/clamp key	Shim screw	Spring
-09	FP1508	L84017-T09P	CN6	CD09-S	DSN090310	T09P-2	C03007-T09P	S5608
C4...-15	FP2012	L86026-T20P	CN6	CD16-S	DSN150624	T20P-7L	C05010-T20P	S7010
C5, C6...-12	FP2012	L85021-T15P	CN3	CD12-S	DSN120616	T15P-2	C04008-T15P	S6912
C5, C6...-15	FP2012	L86026-T20P	CN3	CD16-S	DSN150624	T20P-7L	C05010-T20P	S7010
-19	FP2012	L86026-T20P	CN3	CD19-S	DSN190624	T20P-7L	C05010-T20P	S7010

General ISO Turning Holders
Steadyline®
MDT
Mini-Shaft™
Grooving
Parting-off
X4
Adapters Clamping units
Accessories and Spare parts
Workpiece materials

Accessories

For size	Clamp kit	Insert clamping torque	Replacement blade	Torque key
-09	 CD09-S09	 2.0NM	 T00-09P	 T00-09P20
C4..-15	CD16-S16	6.0NM	T00T-20P	T00T-20P60
C5, C6..-12	CD12-S12	3.5NM	T00-15P	T00-15P35
C5, C6..-15	CD16-S16	6.0NM	T00T-20P	T00T-20P60
-19	CD19-S19	6.0NM	T00T-20P	T00T-20P60

General ISO Turning
Holders

Steadyline®

MDT

Mini-Shaft™

Grooving

Parting-off

X4

Adapters
Clamping units

Accessories and
Spare parts

Workpiece
materials

C.-DSKNR/L...-M and C.-DSKNR/L – Toolholders for inserts SNGA, SNMA, SNMG and SNMM – Metric/ Inch

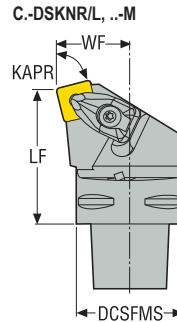
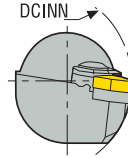

C.-DSKNR/L...-M
KAPR = 75,0 °

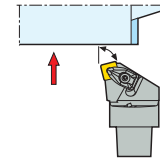

CTWS



- For inserts program, see page(s) 550, 551, 552, 553, 585
- GAMO° = Rake angle, LAMS° = Inclination angle
- CTMS = Seco-Capto™ size
- CTWS = Insert shape and size
- For holder code key, see page(s) 11-12
- Shim DSN120416 for insert SN..1206..., to be ordered separately
- Shim DSN190640 for insert SN..190624..., to be ordered separately
- Right-hand version shown
- Please check availability at www.secotools.com / Seco Online Store

Designation	Item number	CTMS	DCSFMS		LF	DCINN	DCINN3	KAPR°	GAMO°	LAMS°	Weight	CTWS
			mm	Inch								
C4-DSKNR-27050-12-M	02587985	C4	40,0	27,0	50,0	110,0	110,0	75,0	-6,0	-6,0	0,5	SN..1204.. SN..43.
			1.575	1.063	1.969	4.331	4.331				1.100	
C4-DSKNL-27050-12-M	02587986	C4	40,0	27,0	50,0	110,0	110,0	75,0	-6,0	-6,0	0,5	SN..1204.. SN..43.
			1.575	1.063	1.969	4.331	4.331				1.100	
C6-DSKNR-45065-19-M	02588001	C6	63,0	45,0	65,0	125,0	125,0	75,0	-6,0	-6,0	1,3	SN..1906.. SN..64.
			2.480	1.772	2.559	4.921	4.921				2.870	
C6-DSKNL-45065-19-M	02588002	C6	63,0	45,0	65,0	125,0	125,0	75,0	-6,0	-6,0	1,3	SN..1906.. SN..64.
			2.480	1.772	2.559	4.921	4.921				2.870	
C8-DSKNR-55080-19	02597490	C8	80,0	55,0	80,0	125,0	125,0	75,0	-6,0	-6,0	2,6	SN..1906.. SN..64.
			3.150	2.165	3.150	4.921	4.921				5.730	
C8-DSKNL-55080-19	02597074	C8	80,0	55,0	80,0	125,0	125,0	75,0	-6,0	-6,0	2,6	SN..1906.. SN..64.
			3.150	2.165	3.150	4.921	4.921				5.730	

Spare Parts

For size	Clamp pin	Clamp screw	Coolant nozzle	Floating wedge clamp	Insert shim	Shim/clamp key	Shim screw	Spring
-12	FP2012	L85021-T15P	CN6	CD12-S	DSN120616	T15P-2	C04008-T15P	S6912
C6..19	FP2012	L86026-T20P	CN7	CD19-S	DSN190624	T20P-7L	C05010-T20P	S7010
C8..19	FP2012	L86026-T20P	CN8	CD19-S	DSN190624	T20P-7L	C05010-T20P	S7010

Accessories

For size	Clamp kit	Insert clamping torque	Replacement blade	Torque key
-12	CD12-S12	3.5NM	T00-15P	T00-15P35
C6..19	CD19-S19	6.0NM	T00T-20P	T00T-20P60
C8..19	CD19-S19	6.0NM	T00T-20P	T00T-20P60

C.-DSRNR/L...-M and C.-DSRNL – Toolholders for inserts SNGA, SNMA, SNMG and SNMM – Metric / Inch

C.-DSRNR/L...-M
KAPR = 75,0°

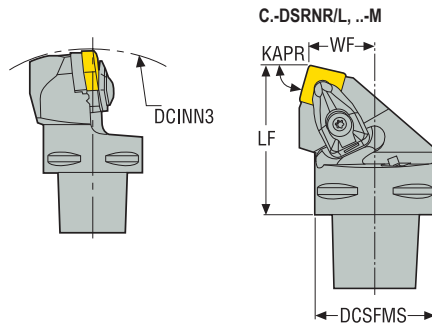
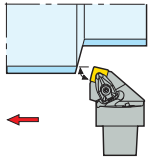

CTWS



- For inserts program, see page(s) 550, 551, 552, 553, 585
- GAMO° = Rake angle, LAMS° = Inclination angle
- CTMS = Seco-Capto™ size
- CTWS = Insert shape and size
- For holder code key, see page(s) 11-12
- Shim DSN120416 for insert SN..1206.., to be ordered separately
- Right-hand version shown
- Please check availability at www.secotools.com / Seco Online Store





Designation	Item number	CTMS	DCSFMS	WF	LF	DCINN	DCINN3	KAPR°	GAMO°	LAMS°	Weight	CTWS
			mm Inch	mm Inch	mm Inch	mm Inch	mm Inch					
C4-DSRNR-22050-12-M	02587935	C4	40,0 1.575	22,0 0.866	50,0 1.969	140,0 5.512	140,0 5.512	75,0	-6,0	-6,0	0,4 0.880	SN..1204.. SN..43.
C4-DSRNL-22050-12-M	02587936	C4	40,0 1.575	22,0 0.866	50,0 1.969	140,0 5.512	140,0 5.512	75,0	-6,0	-6,0	0,4 0.880	SN..1204.. SN..43.
C4-DSRNR-22055-15-M	02587937	C4	40,0 1.575	22,0 0.866	55,0 2.165	165,0 6.496	165,0 6.496	75,0	-6,0	-6,0	0,5 1.100	SN..1506.. SN..54.
C5-DSRNR-27060-12-M	02587941	C5	50,0 1.969	27,0 1.063	60,0 2.362	165,0 6.496	165,0 6.496	75,0	-6,0	-6,0	0,7 1.540	SN..1204.. SN..43.
C5-DSRNL-27060-12-M	02587942	C5	50,0 1.969	27,0 1.063	60,0 2.362	165,0 6.496	165,0 6.496	75,0	-6,0	-6,0	0,7 1.540	SN..1204.. SN..43.
C6-DSRNR-35065-15-M	02587949	C6	63,0 2.480	35,0 1.378	65,0 2.559	190,0 7.480	190,0 7.480	75,0	-6,0	-6,0	1,2 2.650	SN..1506.. SN..54.
C6-DSRNL-35065-15-M	02587950	C6	63,0 2.480	35,0 1.378	65,0 2.559	190,0 7.480	190,0 7.480	75,0	-6,0	-6,0	1,2 2.650	SN..1506.. SN..54.
C8-DSRNR-45080-19	02619061	C8	80,0 3.150	45,0 1.772	80,0 3.150	250,0 9.843	250,0 9.843	75,0	-6,0	-6,0	2,4 5.290	SN..1906.. SN..64.
C8-DSRNL-45080-19	02619062	C8	80,0 3.150	45,0 1.772	80,0 3.150	250,0 9.843	250,0 9.843	75,0	-6,0	-6,0	2,4 5.290	SN..1906.. SN..64.

Spare Parts

For size	Clamp pin	Clamp screw	Coolant nozzle	Floating wedge clamp	Insert shim	Shim/clamp key	Shim screw	Spring
-12	FP2012	L85021-T15P	CN3	CD12-S	DSN120616	T15P-2	C04008-T15P	S6912
C4..-15	FP2012	L86026-T20P	CN6	CD16-S	DSN150624	T20P-7L	C05010-T20P	S7010
C6..-15	FP2012	L86026-T20P	CN3	CD16-S	DSN150624	T20P-7L	C05010-T20P	S7010
-19	FP2012	L86026-T20P	CN3	CD19-S	DSN190624	T20P-7	C05010-T20P	S7010

General ISO Turning Holders
Steadyline®
MDT
Mini-Shaft™
Grooving
Parting-off
X4
Adapters Clamping units
Accessories and Spare parts
Workpiece materials

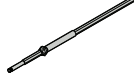
Accessories

For size	Clamp kit	Insert clamping torque	Replacement blade	Torque key
-12	 CD12-S12	 3.5NM	 T00-15P	 T00-15P35
C4..-15	CD16-S16	6.0NM	T00T-20P	T00T-20P60
C6..-15	CD16-S16	6.0NM	T00T-20P	T00T-20P60
-19	CD19-S19	6.0NM	T00T-20P	T00T-20P60

General ISO Turning
Holders

Steadyline®

MDT

Mini-Shaft™

Grooving

Parting-off

X4

Adapters
Clamping units

Accessories and
Spare parts

Workpiece
materials

C.-DSSNR/L...-M – Toolholders for inserts SNGA, SNMA, SNMG and SNMM – Metric / Inch

C.-DSSNR/L...-M
KAPR = 45,0°

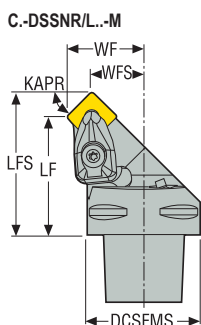
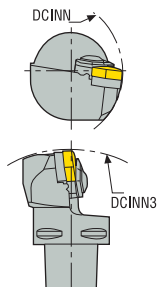
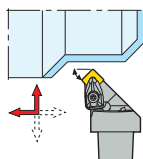

CTWS



- For inserts program, see page(s) 550, 551, 552, 553, 585
- GAMO° = Rake angle, LAMS° = Inclination angle
- CTMS = Seco-Capto™ size
- CTWS = Insert shape and size
- For holder code key, see page(s) 11-12
- Shim DSN120416 for insert SN..1206.., to be ordered separately
- Right-hand version shown
- Please check availability at www.secotools.com / Seco Online Store

Designation	Item number	CTMS	DCSFMS	WF	LF	DCINN	DCINN3	KAPR°	GAMO°	LAMS°	Weight	CTWS
C4-DSSNR-27042-12-M	02587955	C4	40,0 1.575	27,0 1.063	42,0 1.654	110,0 4.331	140,0 5.512	45,0	-8,0	0,0	0,4 0.880	SN..1204.. SN..43.
C4-DSSNL-27042-12-M	02587956	C4	40,0 1.575	27,0 1.063	42,0 1.654	110,0 4.331	140,0 5.512	45,0	-8,0	0,0	0,4 0.880	SN..1204.. SN..43.
C5-DSSNR-35052-12-M	02587961	C5	50,0 1.969	35,0 1.378	52,0 2.047	110,0 4.331	165,0 6.496	45,0	-8,0	0,0	0,7 1.540	SN..1204.. SN..43.
C5-DSSNL-35052-12-M	02587962	C5	50,0 1.969	35,0 1.378	52,0 2.047	110,0 4.331	165,0 6.496	45,0	-8,0	0,0	0,7 1.540	SN..1204.. SN..43.
C5-DSSNR-35050-15-M	02587963	C5	50,0 1.969	35,0 1.378	50,0 1.969	125,0 4.921	165,0 6.496	45,0	-8,0	0,0	0,6 1.320	SN..1506.. SN..54.
C5-DSSNL-35050-15-M	02587964	C5	50,0 1.969	35,0 1.378	50,0 1.969	125,0 4.921	165,0 6.496	45,0	-8,0	0,0	0,6 1.320	SN..1506.. SN..54.
C6-DSSNR-45056-12-M	02587967	C6	63,0 2.480	45,0 1.772	56,0 2.205	110,0 4.331	190,0 7.480	45,0	-8,0	0,0	1,1 2.430	SN..1204.. SN..43.
C6-DSSNL-45056-12-M	02587968	C6	63,0 2.480	45,0 1.772	56,0 2.205	110,0 4.331	190,0 7.480	45,0	-8,0	0,0	1,1 2.430	SN..1204.. SN..43.
C6-DSSNR-45052-19-M	02587971	C6	63,0 2.480	45,0 1.772	52,0 2.047	125,0 4.921	190,0 7.480	45,0	-8,0	0,0	1,1 2.430	SN..1906.. SN..64.
C6-DSSNL-45052-19-M	02587972	C6	63,0 2.480	45,0 1.772	52,0 2.047	125,0 4.921	190,0 7.480	45,0	-8,0	0,0	1,1 2.430	SN..1906.. SN..64.
C8-DSSNR-55070-25-09	02640505	C8	80,0 3.150	55,0 2.165	70,0 2.756	150,0 5.906	256,0 10.079	45,0	-8,0	0,0	2,3 5.070	SN..2509.. SN..86.

Spare Parts

For size	Clamp kit	Clamp pin	Clamp screw	Coolant nozzle	Floating wedge clamp	Insert shim	Shim/clamp key	Shim screw	Spring
C4.-12	–	FP2012	L85021-T15P	CN6	CD12-S	DSN120616	T15P-2	C04008-T15P	S6912
C5.-12	–	FP2012	L85021-T15P	CN7	CD12-S	DSN120616	T15P-2	C04008-T15P	S6912
-15	–	FP2012	L86026-T20P	CN7	CD16-S	DSN150624	T20P-7L	C05010-T20P	S7010
C6.-12	–	FP2012	L85021-T15P	CN3	CD12-S	DSN120616	T15P-2	C04008-T15P	S6912
-19	–	FP2012	L86026-T20P	CN7	CD19-S	DSN190624	T20P-7L	C05010-T20P	S7010
-25	CD25-S25	–	–	–	–	DSN250424	T25P-7	C06012-T25P	–

General ISO Turning
Holders

Steadyline®

MDT

Mini-Shaft™

Grooving

Parting-off

X4

Adapters
Clamping units

Accessories and
Spare parts

Workpiece
materials

General ISO Turning
Holders

Steadyline®

MDT

Mini-Shaft™

Grooving

Parting-off





X4

Adapters
Clamping units

Accessories and
Spare parts

Workpiece
materials

Accessories

For size	Clamp kit	Insert clamping torque	Replacement blade	Torque key
C4..-12	 CD12-S12	 3.5NM	 T00-15P	 T00-15P35
C5..-12	CD12-S12	3.5NM	T00-15P	T00-15P35
-15	CD16-S16	6.0NM	T00T-20P	T00T-20P60
C6..-12	CD12-S12	3.5NM	T00-15P	T00-15P35
-19	CD19-S19	6.0NM	T00T-20P	T00T-20P60
-25	-	-	-	-

C.-DTFNR/L...-M – Toolholders for inserts TNGA, TNMA, TNMG and TNMM – Metric/ Inch

C.-DTFNR...M
KAPR = 90,0°

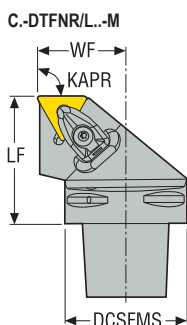
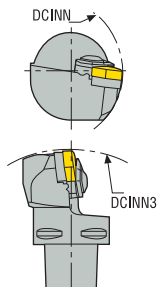
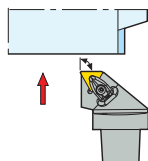









CTWS



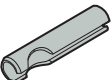



- For inserts program, see page(s) 558, 559, 560, 561, 590
- GAMO° = Rake angle, LAMS° = Inclination angle
- CTWS = Seco-Capto™ size
- CTWS = Insert shape and size
- For holder code key, see page(s) 11-12
- Shim DTN220640 for insert TN..220432.., to be ordered separately
- Right-hand version shown
- Please check availability at www.secotools.com / Seco Online Store

Designation	Item number	CTMS	DCSFMS	WF	LF	DCINN	DCINN3	KAPR°	GAMO°	LAMS°	Weight	CTWS
C4-DTFNR-27050-16-M	02588029	C4	40,0 1.575	27,0 1.063	50,0 1.969	110,0 4.331	140,0 5.512	90,0	-6,0	-6,0	0,4 0.880	TN..1604.. TN..33.
C4-DTFNL-27050-16-M	02588030	C4	40,0 1.575	27,0 1.063	50,0 1.969	110,0 4.331	140,0 5.512	90,0	-6,0	-6,0	0,4 0.880	TN..1604.. TN..33.
C5-DTFNR-35060-16-M	02588033	C5	50,0 1.969	35,0 1.378	60,0 2.362	110,0 4.331	165,0 6.496	90,0	-6,0	-6,0	0,8 1.760	TN..1604.. TN..33.
C5-DTFNL-35060-16-M	02588034	C5	50,0 1.969	35,0 1.378	60,0 2.362	110,0 4.331	165,0 6.496	90,0	-6,0	-6,0	0,8 1.760	TN..1604.. TN..33.

Spare Parts

For size	Clamp pin	Clamp screw	Coolant nozzle	Floating wedge clamp	Insert shim	Shim/clamp key	Shim screw	Spring
-16	 FP1508	 L84017-T09P	 CN3	 CD09-S	 DTN160616	 T09P-2	 C03007-T09P	 S5608

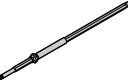
Accessories

For size	Clamp kit	Insert clamping torque	Replacement blade	Torque key
-16	 CD09-S09	 2.0NM	 T00-09P	 T00-09P20

General ISO Turning
Holders

Steadyline®

MDT

Mini-Shaft™

Grooving

Parting-off

X4

Adapters
Clamping units

Accessories and
Spare parts

Workpiece
materials

C-DTGNR/L...-M – Toolholders for inserts TNGA, TNMA, TNMG and TNMM – Metric/ Inch

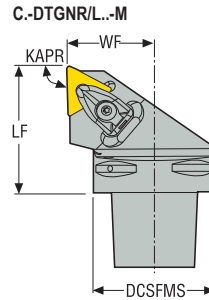
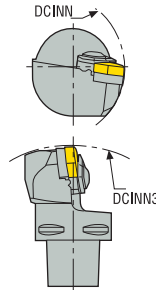

CTWS



- For inserts program, see page(s) 558, 559, 560, 561, 590
- GAMO° = Rake angle, LAMS° = Inclination angle
- CTMS = Seco-Capto™ size
- CTWS = Insert shape and size
- For holder code key, see page(s) 11-12
- Shim DTN220640 for insert TN..220432..., to be ordered separately
- Right-hand version shown
- Please check availability at www.secotools.com / Seco Online Store

Designation	Item number	CTMS	DCSFMS	WF	LF	DCINN	DCINN3	KAPR°	GAMO°	LAMS°	Weight	CTWS
			mm Inch	mm Inch	mm Inch	mm Inch	mm Inch				kg lbs	
C4-DTGNR-27050-22-M	02588017	C4	40,0 1.575	27,0 1.063	50,0 1.969	110,0 4.331	140,0 5.512	90,0	-6,0	-6,0	0,5 1.100	TN..2204.. TN..43.
C4-DTGNL-27050-22-M	02588018	C4	40,0 1.575	27,0 1.063	50,0 1.969	110,0 4.331	140,0 5.512	90,0	-6,0	-6,0	0,5 1.100	TN..2204.. TN..43.

Spare Parts

For size	Clamp pin	Clamp screw	Coolant nozzle	Floating wedge clamp	Insert shim	Shim/clamp key	Shim screw	Spring
-22	FP2012	L85021-T15P	CN3	CD12-S	DTN220616	T15P-2	C04008-T15P	S6912

Accessories

For size	Clamp kit	Insert clamping torque	Replacement blade	Torque key
-22	CD12-S12	3.5NM	T00-15P	T00-15P35

General ISO Turning Holders
Steadyline®
MDT
Mini-Shaft™
Grooving
Parting-off
X4
Adapters Clamping units
Accessories and Spare parts
Workpiece materials

C.-DTJNR/L...-M – Toolholders for inserts TNGA, TNMA, TNMG, TNMM and TNMX – Metric / Inch

C.-DTJNR/L...-M
KAPR = 93,0°

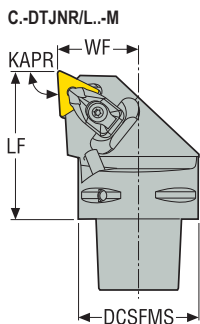
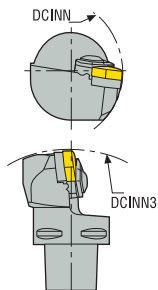
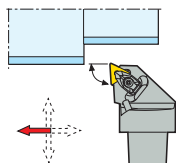

CTWS



- For inserts program, see page(s) 558, 559, 560, 561, 590, 593
- GAMO° = Rake angle, LAMS° = Inclination angle
- CTMS = Seco-Capto™ size
- CTWS = Insert shape and size
- For holder code key, see page(s) 11-12
- Shim DTN220640 for insert TN..220432.., to be ordered separately
- Right-hand version shown
- Please check availability at www.secotools.com / Seco Online Store

Designation	Item number	CTMS	DCSFMS	WF	LF	DCINN	DCINN3	KAPR°	GAMO°	LAMS°	Weight	CTWS
C4-DTJNR-27050-16-M	02588003	C4	40,0 1.575	27,0 1.063	50,0 1.969	110,0 4.331	140,0 5.512	93,0	-6,0	-6,0	0,4 0.880	TN..1604.. TN..33.
C4-DTJNL-27050-16-M	02588004	C4	40,0 1.575	27,0 1.063	50,0 1.969	110,0 4.331	140,0 5.512	93,0	-6,0	-6,0	0,4 0.880	TN..1604.. TN..33.
C5-DTJNR-35060-16-M	02588007	C5	50,0 1.969	35,0 1.378	60,0 2.362	110,0 4.331	165,0 6.496	93,0	-6,0	-6,0	0,8 1.760	TN..1604.. TN..33.
C5-DTJNL-35060-16-M	02588008	C5	50,0 1.969	35,0 1.378	60,0 2.362	110,0 4.331	165,0 6.496	93,0	-6,0	-6,0	0,8 1.760	TN..1604.. TN..33.
C5-DTJNR-35060-22-M	02588009	C5	50,0 1.969	35,0 1.378	60,0 2.362	110,0 4.331	165,0 6.496	93,0	-6,0	-6,0	0,8 1.760	TN..2204.. TN..43.
C5-DTJNL-35060-22-M	02588010	C5	50,0 1.969	35,0 1.378	60,0 2.362	110,0 4.331	165,0 6.496	93,0	-6,0	-6,0	0,8 1.760	TN..2204.. TN..43.
C6-DTJNR-45065-16-M	02588011	C6	63,0 2.480	45,0 1.772	65,0 2.559	110,0 4.331	190,0 7.480	93,0	-6,0	-6,0	1,3 2.870	TN..1604.. TN..33.
C6-DTJNL-45065-16-M	02588012	C6	63,0 2.480	45,0 1.772	65,0 2.559	110,0 4.331	190,0 7.480	93,0	-6,0	-6,0	1,3 2.870	TN..1604.. TN..33.

Spare Parts

For size	Clamp pin	Clamp screw	Coolant nozzle	Floating wedge clamp	Insert shim	Shim/clamp key	Shim screw	Spring
-16	FP1508	L84017-T09P	CN3	CD09-S	DTN160616	T09P-2	C03007-T09P	S5608
-22	FP2012	L85021-T15P	CN3	CD12-S	DTN220616	T15P-2	C04008-T15P	S6912

Accessories

For size	Clamp kit	Insert clamping torque	Replacement blade	Torque key
-16	CD09-S09	2.0NM	T00-09P	T00-09P20
-22	CD12-S12	3.5NM	T00-15P	T00-15P35

General ISO Turning
Holders

Steadyline®

MDT

Mini-Shaft™

Grooving

Parting-off

X4

Adapters
Clamping units

Accessories and
Spare parts

Workpiece
materials

C.-DVJNR/L – Toolholders for inserts VNGA, VNGG, VNGM, VNMA, VNMG and VNMU – Metric/ Inch

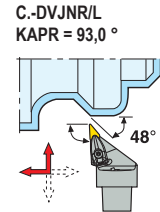
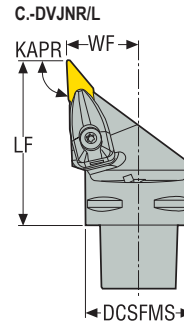
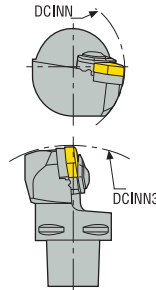

CTWS



- For inserts program, see page(s) 565, 566, 595
- GAMO° = Rake angle, LAMS° = Inclination angle
- CTMS = Seco-Capto™ size
- CTWS = Insert shape and size
- For holder code key, see page(s) 11-12
- Right-hand version shown
- Please check availability at www.secotools.com / Seco Online Store

Designation	Item number	CTMS	DCSFMS		LF	DCINN	DCINN3	KAPR°	GAMO°	LAMS°	Weight		CTWS
			mm	mm							kg	lbs	
C4-DVJNR-27062-16	02588047	C4	40,0 1.575	27,0 1.063	62,0 2.441	65,0 2.559	152,0 5.984	93,0	-4,0	-13,0	0,4 0.880		VN..1604.. VN..33.
C4-DVJNL-27062-16	02588048	C4	40,0 1.575	27,0 1.063	62,0 2.441	65,0 2.559	152,0 5.984	93,0	-4,0	-13,0	0,4 0.880		VN..1604.. VN..33.
C5-DVJNR-35065-16	02588049	C5	50,0 1.969	35,0 1.378	65,0 2.559	65,0 2.559	170,0 6.693	93,0	-4,0	-13,0	0,7 1.540		VN..1604.. VN..33.
C5-DVJNL-35065-16	02588050	C5	50,0 1.969	35,0 1.378	65,0 2.559	65,0 2.559	170,0 6.693	93,0	-4,0	-13,0	0,7 1.540		VN..1604.. VN..33.
C6-DVJNR-45065-16	02588051	C6	63,0 2.480	45,0 1.772	65,0 2.559	81,0 3.189	190,0 7.480	93,0	-4,0	-13,0	1,1 2.430		VN..1604.. VN..33.
C6-DVJNL-45065-16	02588052	C6	63,0 2.480	45,0 1.772	65,0 2.559	81,0 3.189	190,0 7.480	93,0	-4,0	-13,0	1,1 2.430		VN..1604.. VN..33.

Spare Parts

For size	Clamp pin	Clamp screw	Coolant nozzle	Floating wedge clamp	Insert shim	Shim/clamp key	Shim screw	Spring
C4...16	FP2012	L85021-T15P	CN6	CD19-S-V16	DVN160310	T15P-2	C03508-T15P	S6912
C5, C6...16	FP2012	L85021-T15P	CN7	CD19-S-V16	DVN160310	T15P-2	C03508-T15P	S6912

Accessories

For size	Clamp kit	Insert clamping torque	Replacement blade	Torque key
C4...16	CD19-V16	3.5NM	T00-15P	T00-15P35
C5, C6...16	CD19-V16	3.5NM	T00-15P	T00-15P35

C.-DWLNR/L – Toolholders for inserts WNGA, WNGG, WNMA, WNMG and WNMM – Metric / Inch

C.-DWLNR/L
KAPR = 95,0°

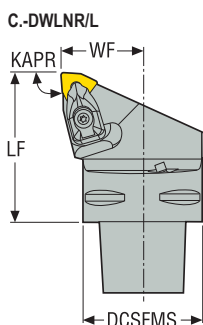
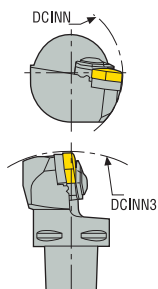
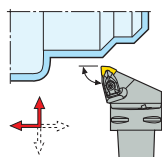

CTWS



- For inserts program, see page(s) 568, 569, 570, 571, 596
- GAMO° = Rake angle, LAMS° = Inclination angle
- CTWS = Seco-Capto™ size
- CTWS = Insert shape and size
- For holder code key, see page(s) 11-12
- Right-hand version shown
- * Use the right shim & the right screw for the selected insert. For details, see page 99
- Please check availability at www.secotools.com / Seco Online Store





Designation	Item number	CTMS	DCSFMS	WF	LF	DCINN	DCINN3	KAPR°	GAMO°	LAMS°	Weight	CTWS
C4-DWLNR-27050-06	02588053	C4	40,0 1.575	27,0 1.063	50,0 1.969	60,0 2.362	140,0 5.512	95,0	-6,0	-6,0	0,4 0.880	WN..0604.. WN..33.
C4-DWLN-27050-06	02588054	C4	40,0 1.575	27,0 1.063	50,0 1.969	60,0 2.362	140,0 5.512	95,0	-6,0	-6,0	0,4 0.880	WN..0604.. WN..33.
C4-DWLNR-27050-08	02588055	C4	40,0 1.575	27,0 1.063	50,0 1.969	110,0 4.331	140,0 5.512	95,0	-6,0	-6,0	0,4 0.880	WN..0804/WN..0806 WN..43/WN..44*
C4-DWLN-27050-08	02588056	C4	40,0 1.575	27,0 1.063	50,0 1.969	110,0 4.331	140,0 5.512	95,0	-6,0	-6,0	0,4 0.880	WN..0804/WN..0806 WN..43/WN..44*
C5-DWLNR-35060-06	02588057	C5	50,0 1.969	35,0 1.378	60,0 2.362	65,0 2.559	165,0 6.496	95,0	-6,0	-6,0	0,5 1.100	WN..0604.. WN..33.
C5-DWLN-35060-06	02588058	C5	50,0 1.969	35,0 1.378	60,0 2.362	65,0 2.559	165,0 6.496	95,0	-6,0	-6,0	0,5 1.100	WN..0604.. WN..33.
C5-DWLNR-35060-08	02588059	C5	50,0 1.969	35,0 1.378	60,0 2.362	110,0 4.331	165,0 6.496	95,0	-6,0	-6,0	0,7 1.540	WN..0804/WN..0806 WN..43/WN..44*
C5-DWLN-35060-08	02588060	C5	50,0 1.969	35,0 1.378	60,0 2.362	110,0 4.331	165,0 6.496	95,0	-6,0	-6,0	0,7 1.540	WN..0804/WN..0806 WN..43/WN..44*
C6-DWLNR-45065-06	02588061	C6	63,0 2.480	45,0 1.772	65,0 2.559	81,0 3.189	190,0 7.480	95,0	-6,0	-6,0	1,3 2.870	WN..0604.. WN..33.
C6-DWLN-45065-06	02588062	C6	63,0 2.480	45,0 1.772	65,0 2.559	81,0 3.189	190,0 7.480	95,0	-6,0	-6,0	1,3 2.870	WN..0604.. WN..33.
C6-DWLNR-45065-08	02588063	C6	63,0 2.480	45,0 1.772	65,0 2.559	110,0 4.331	190,0 7.480	95,0	-6,0	-6,0	1,3 2.870	WN..0804/WN..0806 WN..43/WN..44*
C6-DWLN-45065-08	02588064	C6	63,0 2.480	45,0 1.772	65,0 2.559	110,0 4.331	190,0 7.480	95,0	-6,0	-6,0	1,3 2.870	WN..0804/WN..0806 WN..43/WN..44*

Spare Parts

For size	Clamp pin	Clamp screw	Coolant nozzle	Floating wedge clamp	Insert shim	Shim/clamp key	Shim screw	Spring
C4..-06	FP1508	L84017-T09P	CN6	CD09-S	DWN060310	T09P-2	C03007-T09P	S5608
C4..-08	FP2012	L85021-T15P	CN6	CD12-S	DWN080416	T15P-2	C04008-T15P	S6912
C5, C6..-06	FP1508	L84017-T09P	CN3	CD09-S	DWN060310	T09P-2	C03007-T09P	S5608
C5, C6..-08	FP2012	L85021-T15P	CN3	CD12-S	DWN080416	T15P-2	C04008-T15P	S6912

General ISO Turning Holders
Steadyline®
MDT
Mini-Shaft™
Grooving
Parting-off
X4
Adapters Clamping units
Accessories and Spare parts
Workpiece materials

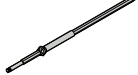
Accessories

For size	Clamp kit	Insert clamping torque	Insert shim	Replacement blade	Torque key
C4...06	 CD09-S09	 2.0NM	 -	 T00-09P	 T00-09P20
C4...08	CD12-S12	3.5NM	DWN080316	T00-15P	T00-15P35
C5, C6...06	CD09-S09	2.0NM	-	T00-09P	T00-09P20
C5, C6...08	CD12-S12	3.5NM	DWN080316	T00-15P	T00-15P35

General ISO Turning
Holders

Steadyline®

MDT

Mini-Shaft™

Grooving

Parting-off

X4

Adapters
Clamping units

Accessories and
Spare parts

Workpiece
materials

C.-PCLNR/L – Toolholders for inserts CNGA, CNGG, CNMA, CNMG and CNMM – Metric / Inch

C.-PCLNR/L
KAPR = 95,0°

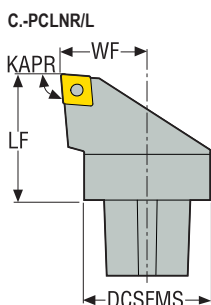
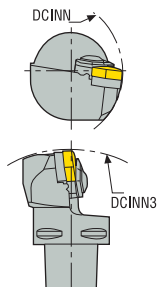
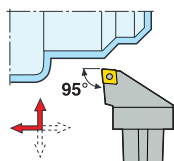













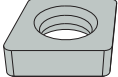













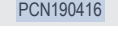

CTWS



- For inserts program, see page(s) 527, 528, 529, 530, 531, 532, 533, 575, 576
- GAMO° = Rake angle, LAMS° = Inclination angle
- CTMS = Seco-Capto™ size
- CTWS = Insert shape and size
- For holder code key, see page(s) 11-12
- Right-hand version shown
- Please check availability at www.secotools.com / Seco Online Store

Designation	Item number	CTMS	DCSFMS		WF	LF	DCINN	DCINN3	KAPR°	GAMO°	LAMS°	Weight	CTWS					
			mm	Inch										mm	Inch	kg	lbs	
C5-PCLNR-35060-16	02617872	C5	50,0	1.969	35,0	1.378	60,0	2.362	100,0	3.937	150,0	5.906	95,0	-6,0	-6,0	0,8	1.760	CN..1606.. CN..54.
C5-PCLNL-35060-16	02902843	C5	50,0	1.969	35,0	1.378	60,0	2.362	100,0	3.937	150,0	5.906	95,0	-6,0	-6,0	0,7	1.540	CN..1606.. CN..54.
C6-PCLNR-45065-16	00045792	C6	63,0	2.480	45,0	1.772	65,0	2.559	120,0	4.724	200,0	7.874	95,0	-6,0	-6,0	1,5	3.310	CN..1606.. CN..54.
C6-PCLNL-45065-16	00070115	C6	63,0	2.480	45,0	1.772	65,0	2.559	120,0	4.724	200,0	7.874	95,0	-6,0	-6,0	1,5	3.310	CN..1606.. CN..54.
C6-PCLNR-45065-19	02452428	C6	63,0	2.480	45,0	1.772	65,0	2.559	120,0	4.724	200,0	7.874	95,0	-6,0	-6,0	1,5	3.310	CN..1906.. CN..64.
C6-PCLNL-45065-19	02466284	C6	63,0	2.480	45,0	1.772	65,0	2.559	120,0	4.724	200,0	7.874	95,0	-6,0	-6,0	1,5	3.310	CN..1906.. CN..64.
C8-PCLNR-55080-19	02207793	C8	80,0	3.150	55,0	2.165	80,0	3.150	120,0	4.724	220,0	8.661	95,0	-6,0	-6,0	3,0	6.610	CN..1906.. CN..64.
C8-PCLNL-55080-19	02527457	C8	80,0	3.150	55,0	2.165	80,0	3.150	120,0	4.724	220,0	8.661	95,0	-6,0	-6,0	3,0	6.610	CN..1906.. CN..64.
C10-PCLNR-68110-25	02902846	C10	100,0	3.937	68,0	2.677	110,0	4.331	240,0	9.449	400,0	15.748	95,0	-6,0	-6,0	5,3	11.680	CN..2509.. CN..86.
C10-PCLNL-68110-25	02902845	C10	100,0	3.937	68,0	2.677	110,0	4.331	240,0	9.449	400,0	15.748	95,0	-6,0	-6,0	5,6	12.350	CN..2509.. CN..86.

Spare Parts

For size	Coolant nozzle	Insert lever	Insert shim	Lever key	Lever screw	Punch	Shim pin
..-16	 CN7	 PP6017	 PCN160412	 3SMS795	 LS0820	 MP1519	 RP8286
C6..-19	 CN7	 PP7521	 PCN190416	 4SMS795	 LS1027	 MP1519	 RP9811
C8..-19	 CN8	 PP7521	 PCN190416	 4SMS795	 LS1027	 MP1519	 RP9811
..-25	 CN16	 PP1325	 PCN250620	 5SMS795	 LS1236	 MP25	 RP1312

Accessories

For size	Insert clamping torque	Replacement blade	Torque key
..-16	-	-	-
C6..-19	5.0NM	H00T-4.0	H00T-4050
C8..-19	5.0NM	H00T-4.0	H00T-4050
..-25	5.0NM	H00T-5.0	H00T-5050

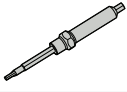

General ISO Turning
Holders

Steadyline®

MDT

Mini-Shaft™

Grooving

Parting-off

X4

Adapters
Clamping units

Accessories and
Spare parts

Workpiece
materials

C.-PSDNN – Toolholders for inserts SNMA, SNMG and SNMM – Metric / Inch

C.-PSDNN
KAPR = 45,0°

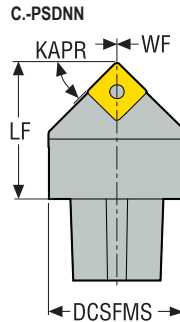
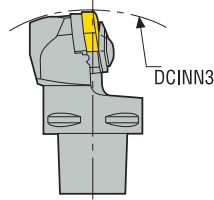
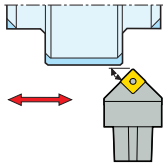

CTWS



- For inserts program, see page(s) 550, 551, 552, 553
- GAMO° = Rake angle, LAMS° = Inclination angle
- CTMS = Seco-Capto™ size
- CTWS = Insert shape and size
- For holder code key, see page(s) 11-12
- Neutral version shown
- Please check availability at www.secotools.com / Seco Online Store

Designation	Item number	CTMS	DCSFMS		WF	LF	DCINN	DCINN3	KAPR°	GAMO°	LAMS°	Weight	CTWS				
			mm	Inch										mm	Inch	kg	lbs
C5-PSDNN-00060-19	02902844	C5	50,0	1.969	0,5	0.020	60,0	2.362	-	130,0	5.118	45,0	-6,0	-6,0	0,8	1.760	SN..1906.. SN..64.
C10-PSDNN-00110-25	02902847	C10	100,0	3.937	0,9863	0.039	110,0	4.331	-	200,0	7.874	45,0	-6,0	-6,0	5,7	12.570	SN..2507.. SN..85.

Spare Parts

For size	Coolant nozzle	Insert lever	Insert shim	Lever key	Lever screw	Punch	Shim pin
..-19	CN7	PP7521	PSN190412	4SMS795	LS1027	MP1519	RP9811
C10..-25	CN16	PP1325	PSN250624	5SMS795	LS1236	MP25	RP1312

Accessories

For size	Insert clamping torque	Replacement blade	Torque key
..-19	5.0NM	H00T-4.0	H00T-4050
C10..-25	5.0NM	H00T-5.0	H00T-5050

General ISO Turning Holders
Steadyline®
MDT
Mini-Shaft™
Grooving
Parting-off
X4
Adapters Clamping units
Accessories and Spare parts
Workpiece materials

C.-PSKNR/L – Toolholders for inserts SNMA, SNMG and SNMM – Metric/ Inch

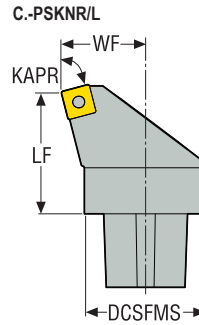
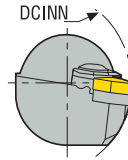

C.-PSKNR/L
KAPR = 75,0 °

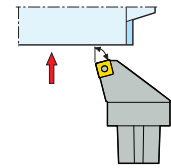

CTWS



- For inserts program, see page(s) 550, 551, 552, 553
- GAMO° = Rake angle, LAMS° = Inclination angle
- CTMS = Seco-Capto™ size
- CTWS = Insert shape and size
- For holder code key, see page(s) 11-12
- Right-hand version shown
- Please check availability at www.secotools.com / Seco Online Store

Designation	Item number	CTMS	DCSFMS	WF	LF	DCINN	DCINN3	KAPR°	GAMO°	LAMS°	Weight		CTWS
											kg	lbs	
			mm Inch	mm Inch	mm Inch	mm Inch	mm Inch						
C6-PSKNR-45065-19	02722448	C6	63,0 2.480	45,0 1.772	65,0 2.559	100,0 3.937	–	75,0	-6,0	-6,0	1,4 3.090		SN..1906.. SN..64.
C6-PSKNL-45065-19	02722449	C6	60,0 2.362	45,0 1.772	65,0 2.559	100,0 3.937	–	75,0	-6,0	-6,0	1,4 3.090		SN..1906.. SN..64.
C8-PSKNR-55080-25	02527456	C8	80,0 3.150	55,0 2.165	80,0 3.150	180,0 7.087	–	75,0	-6,0	-6,0	3,3 7.280		SN..2507.. SN..85.
C8-PSKNL-55080-25	02559645	C8	80,0 3.150	55,0 2.165	80,0 3.150	180,0 7.087	–	75,0	-6,0	-6,0	3,3 7.280		SN..2507.. SN..85.

Spare Parts

For size	Coolant nozzle	Insert lever	Insert shim	Lever key	Lever screw	Punch	Shim pin
..-19	CN7	PP7521	PSN190412	4SMS795	LS1027	MP1519	RP9811
..-25	CN8	PP1325	PSN250624	5SMS795	LS1236	MP25	RP1312

Accessories

For size	Insert clamping torque	Replacement blade	Torque key
..-19	5.0NM	H00T-4.0	H00T-4050
..-25	5.0NM	H00T-5.0	H00T-5050

C.-PSRNR/L – Toolholders for inserts SNMA, SNMG and SNMM – Metric / Inch

C.-PSRNR/L
KAPR = 75,0°

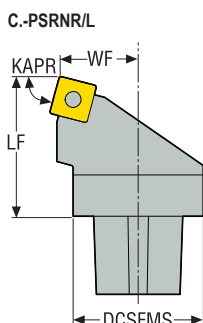
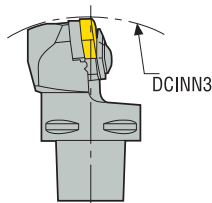
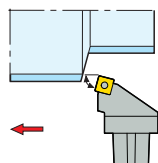













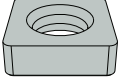







CTWS



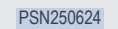

- For inserts program, see page(s) 550, 551, 552, 553
- GAMO° = Rake angle, LAMS° = Inclination angle
- CTWS = Seco-Capto™ size
- CTWS = Insert shape and size
- For holder code key, see page(s) 11-12
- Right-hand version shown
- Please check availability at www.secotools.com / Seco Online Store

Designation	Item number	CTMS	DCSFMS	WF	LF	DCINN	DCINN3	KAPR°	GAMO°	LAMS°	Weight	CTWS
C5-PSRNR-27060-19	02547736	C5	50,0 1.969	27,0 1.063	60,0 2.362	-	130,0 5.118	75,0	-6,0	-6,0	0,9 1.980	SN..1906.. SN..64.
C5-PSRNL-27060-19	02547737	C5	50,0 1.969	27,0 1.063	60,0 2.362	-	130,0 5.118	75,0	-6,0	-6,0	0,9 1.980	SN..1906.. SN..64.
C6-PSRNR-35065-19	02684139	C6	63,0 2.480	35,0 1.378	65,0 2.559	-	160,0 6.299	75,0	-6,0	-6,0	1,4 3.090	SN..1906.. SN..64.
C6-PSRNL-35065-19	02684140	C6	63,0 2.480	35,0 1.378	65,0 2.559	-	160,0 6.299	75,0	-6,0	-6,0	1,4 3.090	SN..1906.. SN..64.
C8-PSRNR-45080-25	02559638	C8	80,0 3.150	45,0 1.772	80,0 3.150	-	220,0 8.661	75,0	-6,0	-6,0	2,4 5.290	SN..2507.. SN..85.
C8-PSRNL-45080-25	02630987	C8	80,0 3.150	45,0 1.772	80,0 3.150	-	220,0 8.661	75,0	-6,0	-6,0	2,4 5.290	SN..2507.. SN..85.
C10-PSRNR-58110-25	02902849	C10	80,0 3.150	58,0 2.283	110,0 4.331	-	320,0 12.598	75,0	-6,0	-6,0	5,3 11.680	SN..2507.. SN..85.
C10-PSRNL-58110-25	02902848	C10	100,0 3.937	58,0 2.283	110,0 4.331	-	320,0 12.598	75,0	-6,0	-6,0	5,3 11.680	SN..2507.. SN..85.

Spare Parts

For size	Coolant nozzle	Insert lever	Insert shim	Lever key	Lever screw	Punch	Shim pin
C5, C6..-19	 CN7	 PP7521	 PSN190412	 4SMS795	 LS1027	 MP1519	 RP9811
C8..-25	 CN8	 PP1325	 PSN250624	 5SMS795	 LS1236	 MP25	 RP1312
C10..-25	 CN16	 PP1325	 PSN250624	 5SMS795	 LS1236	 MP25	 RP1312

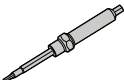
Accessories

For size	Insert clamping torque	Replacement blade	Torque key
C5, C6..-19	 5.0NM	 H00T-4.0	 H00T-4050
C8..-25	5.0NM	H00T-5.0	H00T-5050
C10..-25	5.0NM	H00T-5.0	H00T-5050

C.-PWLNR/L – Toolholders for inserts WNGA, WNGG, WNMA, WNMG and WNMM – Metric/ Inch

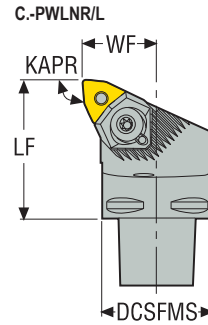
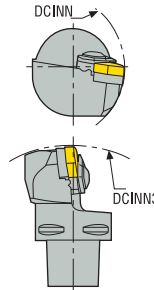

C.-PWLNR/L
KAPR = 95,0 °

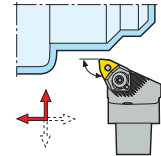

CTWS





- For inserts program, see page(s) 568, 569, 570, 571, 596
- GAMO° = Rake angle, LAMS° = Inclination angle
- CTMS = Seco-Capto™ size
- CTWS = Insert shape and size
- For holder code key, see page(s) 11-12
- Wedge WNW08 for insert WNMM08..., to be ordered separately
- Right-hand version shown
- * Use the right shim & the right screw for the selected insert. For details, see page 99
- Please check availability at www.secotools.com / Seco Online Store

Designation	Item number	CTMS	DCSFMS		LF	DCINN	DCINN3	KAPR°	GAMO°	LAMS°	Weight	CTWS
			mm Inch	mm Inch								
C4-PWLNLR-27050-06	75257218	C4	40,0 1.575	27,0 1.063	50,0 1.969	75,0 2.953	165,0 6.496	95,0	-6,0	-6,0	0,4 0.880	WN..0604.. WN..33.
C4-PWLNLR-27050-06	00092036	C4	40,0 1.575	27,0 1.063	50,0 1.969	75,0 2.953	165,0 6.496	95,0	-6,0	-6,0	0,4 0.880	WN..0604.. WN..33.
C4-PWLNLR-27050-08	00092037	C4	40,0 1.575	27,0 1.063	50,0 1.969	75,0 2.953	165,0 6.496	95,0	-6,0	-6,0	0,4 0.880	WN..0804/WN..0806 WN..43/WN..44*
C4-PWLNLR-27050-08	75069455	C4	40,0 1.575	27,0 1.063	50,0 1.969	75,0 2.953	165,0 6.496	95,0	-6,0	-6,0	0,4 0.880	WN..0804/WN..0806 WN..43/WN..44*
C5-PWLNLR-35060-06	00092039	C5	50,0 1.969	35,0 1.378	60,0 2.362	95,0 3.740	165,0 6.496	95,0	-6,0	-6,0	0,8 1.760	WN..0604.. WN..33.
C5-PWLNLR-35060-06	00089504	C5	50,0 1.969	35,0 1.378	60,0 2.362	95,0 3.740	165,0 6.496	95,0	-6,0	-6,0	0,8 1.760	WN..0604.. WN..33.
C5-PWLNLR-35060-08	75675111	C5	50,0 1.969	35,0 1.378	60,0 2.362	95,0 3.740	165,0 6.496	95,0	-6,0	-6,0	0,8 1.760	WN..0804/WN..0806 WN..43/WN..44*
C5-PWLNLR-35060-08	75675112	C5	50,0 1.969	35,0 1.378	60,0 2.362	95,0 3.740	165,0 6.496	95,0	-6,0	-6,0	0,8 1.760	WN..0804/WN..0806 WN..43/WN..44*
C6-PWLNLR-45065-08	00012511	C6	63,0 2.480	45,0 1.772	65,0 2.559	121,0 4.764	165,0 6.496	95,0	-6,0	-6,0	1,3 2.870	WN..0804/WN..0806 WN..43/WN..44*
C6-PWLNLR-45065-08	00012512	C6	63,0 2.480	45,0 1.772	65,0 2.559	121,0 4.764	165,0 6.496	95,0	-6,0	-6,0	1,3 2.870	WN..0804/WN..0806 WN..43/WN..44*

Spare Parts

For size	Coolant nozzle	Insert shim	Setting screw	Shim pin	Wedge clamp	Wedge key	Wedge screw
C4..06	CN6	WAE060312	L82511-T07P	PP2109-T09P	WNW06HD	T20P-7	WS1920-T20P
C4..08	CN6	WAE080412	L82511-T07P	PP2015-1-T15P	WNW08HD	T25P-7	WS2325-T25P
C5..06	CN7	WAE060312	L82511-T07P	PP2109-T09P	WNW06HD	T20P-7	WS1920-T20P
C5..08	CN6	WAE080412	L82511-T07P	PP2015-1-T15P	WNW08HD	T25P-7	WS2325-T25P
C6..08	CN8	WAE080412	L82511-T07P	PP2015-1-T15P	WNW08HD	T25P-7	WS2325-T25P

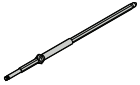
Accessories

For size	Insert clamping torque 	Replacement blade 	Shim key 	Torque key 
C4..-06	3.5NM	T00-20P	T09P-2	T00-20P35
C4..-08	5.0NM	T00T-25P	T15P-2	T00T-25P50
C5..-06	3.5NM	T00-20P	T09P-2	T00-20P35
C5..-08	5.0NM	T00T-25P	T15P-2	T00T-25P50
C6..-08	5.0NM	T00T-25P	T15P-2	T00T-25P50

- General ISO Turning Holders
- Steadyline®
- MDT
- Mini-Shaft™
- Grooving
- Parting-off
- X4
- Adapters Clamping units
- Accessories and Spare parts
- Workpiece materials

C-SCLCR/L – Toolholders for inserts CCGT, CCGW, CCMT and CCMW – Metric/ Inch

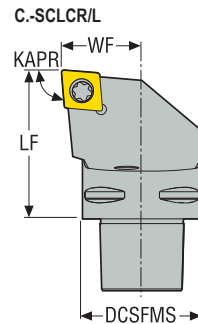

C-SCLCR/L
KAPR = 95,0 °

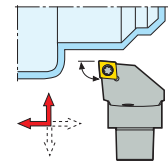

CTWS





- For inserts program, see page(s) 522, 523, 524, 525, 573, 574, 597, 599
- GAMO° = Rake angle, LAMS° = Inclination angle
- CTMS = Seco-Capto™ size
- CTWS = Insert shape and size
- For holder code key, see page(s) 11-12
- Right-hand version shown
- Please check availability at www.secotools.com / Seco Online Store

Designation	Item number	CTMS	DCSFMS		WF		LF		DCINN	DCINN3	KAPR°	GAMO°	LAMS°	Weight	CTWS	
			mm	Inch	mm	Inch	mm	Inch								mm
C3-SCLCR-22040-09	00094076	C3	32,0	1.260	22,0	0.866	40,0	1.575	-	-	95,0	0,0	0,0	0,3	0.660	CC..09T3.. CC..32.5.
C3-SCLCL-22040-09	00094065	C3	32,0	1.260	22,0	0.866	40,0	1.575	-	-	95,0	0,0	0,0	0,3	0.660	CC..09T3.. CC..32.5.
C4-SCLCR-27050-09	00083466	C4	40,0	1.575	27,0	1.063	50,0	1.969	75,0	165,0	95,0	0,0	0,0	0,5	1.100	CC..09T3.. CC..32.5.
C4-SCLCL-27050-09	75069013	C4	40,0	1.575	27,0	1.063	50,0	1.969	75,0	165,0	95,0	0,0	0,0	0,5	1.100	CC..09T3.. CC..32.5.
C4-SCLCR-27050-12	00094168	C4	40,0	1.575	27,0	1.063	50,0	1.969	75,0	165,0	95,0	0,0	0,0	0,5	1.100	CC..1204.. CC..43.
C4-SCLCL-27050-12	00094163	C4	40,0	1.575	27,0	1.063	50,0	1.969	75,0	165,0	95,0	0,0	0,0	0,5	1.100	CC..1204.. CC..43.
C5-SCLCR-35060-09	00094277	C5	50,0	1.969	35,0	1.378	60,0	2.362	95,0	165,0	95,0	0,0	0,0	0,8	1.760	CC..09T3.. CC..32.5.
C5-SCLCL-35060-09	00094261	C5	50,0	1.969	35,0	1.378	60,0	2.362	95,0	165,0	95,0	0,0	0,0	0,8	1.760	CC..09T3.. CC..32.5.
C5-SCLCR-35060-12	00094278	C5	50,0	1.969	35,0	1.378	60,0	2.362	95,0	165,0	95,0	0,0	0,0	0,7	1.540	CC..1204.. CC..43.
C5-SCLCL-35060-12	00094265	C5	50,0	1.969	35,0	1.378	60,0	2.362	95,0	165,0	95,0	0,0	0,0	0,7	1.540	CC..1204.. CC..43.
C6-SCLCR-45065-12	00094313	C6	63,0	2.480	45,0	1.772	65,0	2.559	121,0	165,0	95,0	0,0	0,0	1,4	3.090	CC..1204.. CC..43.
C6-SCLCL-45065-12	00094311	C6	63,0	2.480	45,0	1.772	65,0	2.559	121,0	165,0	95,0	0,0	0,0	1,4	3.090	CC..1204.. CC..43.

Spare Parts

For size	Coolant nozzle	Insert key	Insert screw	Insert shim	Shim screw
C3, C4..-09	CN6	T15P-2	C03512-T15P	SCN090308	CA3507
C3, C4..-12	CN6	T15P-2	C04014-T15P	SCN12T308	CA4010
C5, C6..-09	CN7	T15P-2	C03512-T15P	SCN090308	CA3507
C5, C6..-12	CN7	T15P-2	C04014-T15P	SCN12T308	CA4010

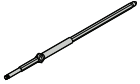
Accessories

For size	Insert clamping torque	Replacement blade	Shim key	Torque key
				
C3, C4..-09	3.0NM	T00-15P	9/64SMS875	T00-15P30
C3, C4..-12	3.5NM	T00-15P	4SMS795	T00-15P35
C5, C6..-09	3.0NM	T00-15P	9/64SMS875	T00-15P30
C5, C6..-12	3.5NM	T00-15P	4SMS795	T00-15P35

General ISO Turning
Holders

Steadyline®

MDT

Mini-Shaft™

Grooving

Parting-off

X4

Adapters
Clamping units

Accessories and
Spare parts

Workpiece
materials

C.-SDJCR/L – Toolholders for inserts DCGT, DCMT, DCMW and DCMX – Metric/ Inch

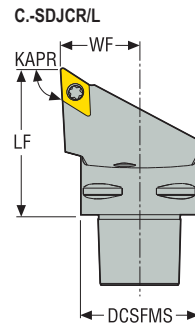

C.-SDJCR/L
KAPR = 93,0 °

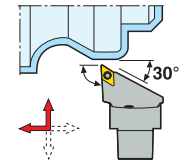

CTWS



- For inserts program, see page(s) 534, 535, 536, 600
- GAMO° = Rake angle, LAMS° = Inclination angle
- CTMS = Seco-Capto™ size
- CTWS = Insert shape and size
- For holder code key, see page(s) 11-12
- Right-hand version shown
- Please check availability at www.secotools.com / Seco Online Store

Designation	Item number	CTMS	DCSFMS		WF		LF		DCINN	DCINN3	KAPR°	GAMO°	LAMS°	Weight	CTWS	
			mm	Inch	mm	Inch	mm	Inch								mm
C3-SDJCR-22040-11	00091724	C3	32,0	1.260	22,0	0.866	40,0	1.575	121,0	4.764	93,0	0,0	0,0	0,3	0.660	DC..11T3.. DC..32.5.
C3-SDJCL-22040-11	00091725	C3	32,0	1.260	22,0	0.866	40,0	1.575	121,0	4.764	93,0	0,0	0,0	0,3	0.660	DC..11T3.. DC..32.5.
C4-SDJCR-27050-11	75080768	C4	40,0	1.575	27,0	1.063	50,0	1.969	75,0	2.953	93,0	0,0	0,0	0,4	0.880	DC..11T3.. DC..32.5.
C4-SDJCL-27050-11	00084487	C4	40,0	1.575	27,0	1.063	50,0	1.969	75,0	2.953	93,0	0,0	0,0	0,4	0.880	DC..11T3.. DC..32.5.
C5-SDJCR-35060-11	00094282	C5	50,0	1.969	35,0	1.378	60,0	2.362	95,0	3.740	93,0	0,0	0,0	0,7	1.540	DC..11T3.. DC..32.5.
C5-SDJCL-35060-11	00094281	C5	50,0	1.969	35,0	1.378	60,0	2.362	95,0	3.740	93,0	0,0	0,0	0,7	1.540	DC..11T3.. DC..32.5.
C6-SDJCR-45065-11	00023659	C6	63,0	2.480	45,0	1.772	65,0	2.559	121,0	4.764	93,0	0,0	0,0	1,1	2.430	DC..11T3.. DC..32.5.
C6-SDJCL-45065-11	00023658	C6	63,0	2.480	45,0	1.772	65,0	2.559	121,0	4.764	93,0	0,0	0,0	1,1	2.430	DC..11T3.. DC..32.5.

Spare Parts

For size	Coolant nozzle	Insert key	Insert screw	Insert shim	Shim screw
C3, C4..-11	CN6	T15P-2	C03512-T15P	126.19-620	CA3507
C5, C6..-11	CN7	T15P-2	C03512-T15P	126.19-620	CA3507

Accessories

For size	Insert clamping torque	Replacement blade	Shim key	Torque key
C3, C4..-11	3.0NM	T00-15P	9/64SMS875	T00-15P30
C5, C6..-11	3.0NM	T00-15P	9/64SMS875	T00-15P30

C.-SDNCN – Toolholders for inserts DCGT, DCMT and DCMW – Metric/ Inch



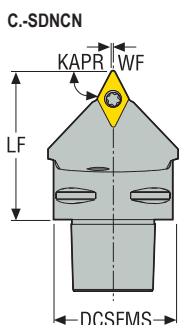
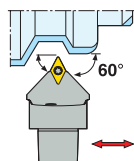







C.-SDNCN
KAPR = 62,5°









- For inserts program, see page(s) 534, 535, 536, 600
- GAMO° = Rake angle, LAMS° = Inclination angle
- CTMS = Seco-Capto™ size
- CTWS = Insert shape and size
- For holder code key, see page(s) 11-12
- Neutral version shown
- Please check availability at www.secotools.com / Seco Online Store

Designation	Item number	CTMS	DCSFMS	WF	LF	DCINN	DCINN3	KAPR°	GAMO°	LAMS°	Weight	CTWS
C4-SDNCN-00050-11	00083467	C4	40,0 1.575	0,5 0.020	50,0 1.969	–	165,0 6.496	62,5	0,0	0,0	0,4 0.880	DC..11T3.. DC..32.5.
C5-SDNCN-00060-11	00094283	C5	50,0 1.969	0,5 0.020	60,0 2.362	–	165,0 6.496	62,5	0,0	0,0	0,6 1.320	DC..11T3.. DC..32.5.

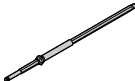
Spare Parts

For size	Coolant nozzle	Insert key	Insert screw	Insert shim	Shim screw
C3, C4..-11	 CN6	 T15P-2	 C03512-T15P	 126.19-620	 CA3507
C5..-11	 CN7	 T15P-2	 C03512-T15P	 126.19-620	 CA3507

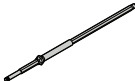
Accessories

For size	Insert clamping torque	Replacement blade	Shim key	Torque key
C3, C4..-11	 3.0NM	 T00-15P	 9/64SMS875	 T00-15P30
C5..-11	 3.0NM	 T00-15P	 9/64SMS875	 T00-15P30

General ISO Turning
Holders

Steadyline®

MDT

Mini-Shaft™

Grooving

Parting-off

X4

Adapters
Clamping units

Accessories and
Spare parts

Workpiece
materials

C.-SRDCN – Toolholders for inserts RCMT – Metric / Inch

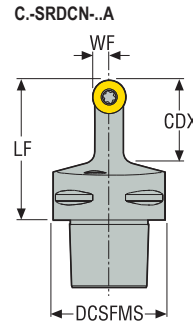

C.-SRDCN-..A
KAPR = 45,0 °

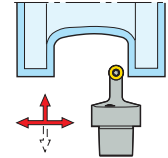

CTWS





- For inserts program, see page(s) 545, 546
- GAMO° = Rake angle, LAMS° = Inclination angle
- CTMS = Seco-Capto™ size
- CTWS = Insert shape and size
- For holder code key, see page(s) 11-12
- Neutral version shown
- Please check availability at www.secotools.com / Seco Online Store

Designation	Item number	CTMS	DCSFMS		WF		LF	DCINN	DCINN3	KAPR°	GAMO°	LAMS°	Weight	CTWS			
			mm	Inch	mm	Inch									mm	Inch	
C4-SRDCN-00050-12A	00094192	C4	40,0	1.575	6,0	0.236	50,0	1.969	-	165,0	6.496	45,0	0,0	0,0	0,3	0.660	RC..1204..
C5-SRDCN-00060-06A	00094341	C5	50,0	1.969	3,0	0.118	60,0	2.362	-	165,0	6.496	45,0	0,0	0,0	0,7	1.540	RC..0602..
C5-SRDCN-00060-08A	00094342	C5	50,0	1.969	4,0	0.157	60,0	2.362	-	165,0	6.496	45,0	0,0	0,0	0,7	1.540	RC..0803..
C5-SRDCN-00060-10A	00094229	C5	50,0	1.969	5,0	0.197	60,0	2.362	-	165,0	6.496	45,0	0,0	0,0	0,8	1.760	RC..10T3..
C5-SRDCN-00060-12A	00094344	C5	50,0	1.969	6,0	0.236	60,0	2.362	-	165,0	6.496	45,0	0,0	0,0	0,6	1.320	RC..1204..
C5-SRDCN-00060-16A	00094345	C5	50,0	1.969	8,0	0.315	60,0	2.362	-	165,0	6.496	45,0	0,0	0,0	0,6	1.320	RC..1606..
C6-SRDCN-00065-10A	00094314	C6	63,0	2.480	5,0	0.197	65,0	2.559	-	165,0	6.496	45,0	0,0	0,0	1,1	2.430	RC..10T3..
C6-SRDCN-00065-12A	00094315	C6	63,0	2.480	6,0	0.236	65,0	2.559	-	165,0	6.496	45,0	0,0	0,0	1,0	2.200	RC..1204..
C6-SRDCN-00065-16A	00094317	C6	63,0	2.480	8,0	0.315	65,0	2.559	-	165,0	6.496	45,0	0,0	0,0	0,9	1.980	RC..1606..

Spare Parts

For size	Coolant nozzle	Insert key	Insert screw	Insert shim	Shim screw
C4...12	CN6	T15P-2	C03512-T15P	111.19-621	CA3507
-06	CN7	T07P-2	C02506-T07P	-	-
-08	CN7	T09P-2	C03007-T09P	-	-
-10	CN7	T15P-2	C03510-T15P	111.19-620	CA3507
C5, C6...12	CN7	T15P-2	C03512-T15P	111.19-621	CA3507
-16	CN7	T20P-7	C05018-T20P	SRN160400	CA5010

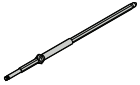
Accessories

For size	Insert clamping torque 	Replacement blade 	Shim key 	Torque key 
C4..-12	3.0NM	T00-15P	9/64SMS875	T00-15P30
-06	0.9NM	T00-07P	-	T00-07P09
-08	2.0NM	T00-09P	-	T00-09P20
-10	3.0NM	T00-15P	9/64SMS875	T00-15P30
C5, C6..-12	3.0NM	T00-15P	9/64SMS875	T00-15P30
-16	5.0NM	T00-20P	5SMS795	T00-20P50

- General ISO Turning Holders
- Steadyline®
- MDT
- Mini-Shaft™
- Grooving
- Parting-off
- X4
- Adapters Clamping units
- Accessories and Spare parts
- Workpiece materials

C.-SRSCR/L – Toolholders for inserts RCMT – Metric/ Inch



CTWS





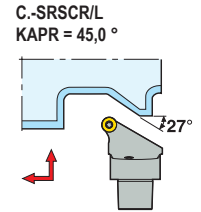
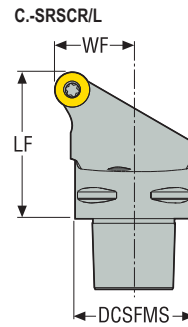

- For inserts program, see page(s) 545, 546
- GAMO° = Rake angle, LAMS° = Inclination angle
- CTMS = Seco-Capto™ size
- CTWS = Insert shape and size
- For holder code key, see page(s) 11-12
- Right-hand version shown
- Please check availability at www.secotools.com / Seco Online Store



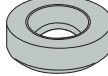

Designation	Item number	CTMS	DCSFMS		WF		LF		DCINN	DCINN3	KAPR°	GAMO°	LAMS°	Weight	CTWS			
			mm	Inch	mm	Inch	mm	Inch								mm	Inch	
C5-SRSCR-35060-06	00094353	C5	50,0	1.969	35,0	1.378	60,0	2.362	95,0	3.740	165,0	6.496	45,0	0,0	0,0	0,7	1.540	RC..0602..
C5-SRSL-35060-06	00094347	C5	50,0	1.969	35,0	1.378	60,0	2.362	95,0	3.740	165,0	6.496	45,0	0,0	0,0	0,7	1.540	RC..0602..
C5-SRSCR-35060-08	00094354	C5	50,0	1.969	35,0	1.378	60,0	2.362	95,0	3.740	165,0	6.496	45,0	0,0	0,0	0,7	1.540	RC..0803..
C5-SRSL-35060-08	00094348	C5	50,0	1.969	35,0	1.378	60,0	2.362	95,0	3.740	165,0	6.496	45,0	0,0	0,0	0,7	1.540	RC..0803..
C5-SRSCR-35060-10	00094355	C5	50,0	1.969	35,0	1.378	60,0	2.362	95,0	3.740	165,0	6.496	45,0	0,0	0,0	0,7	1.540	RC..10T3..
C5-SRSL-35060-10	00094349	C5	50,0	1.969	35,0	1.378	60,0	2.362	95,0	3.740	165,0	6.496	45,0	0,0	0,0	0,7	1.540	RC..10T3..
C5-SRSCR-35060-12	00094356	C5	50,0	1.969	35,0	1.378	60,0	2.362	95,0	3.740	165,0	6.496	45,0	0,0	0,0	0,8	1.760	RC..1204..
C5-SRSL-35060-12	00094350	C5	50,0	1.969	35,0	1.378	60,0	2.362	95,0	3.740	165,0	6.496	45,0	0,0	0,0	0,8	1.760	RC..1204..
C5-SRSCR-35060-16	00094357	C5	50,0	1.969	35,0	1.378	60,0	2.362	140,0	5.512	165,0	6.496	45,0	0,0	0,0	0,8	1.760	RC..1606..
C5-SRSL-35060-16	00094351	C5	50,0	1.969	35,0	1.378	60,0	2.362	140,0	5.512	165,0	6.496	45,0	0,0	0,0	0,8	1.760	RC..1606..
C6-SRSCR-45065-10	00094323	C6	63,0	2.480	45,0	1.772	65,0	2.559	121,0	4.764	165,0	6.496	45,0	0,0	0,0	1,2	2.650	RC..10T3..
C6-SRSL-45065-10	00094319	C6	63,0	2.480	45,0	1.772	65,0	2.559	121,0	4.764	165,0	6.496	45,0	0,0	0,0	1,2	2.650	RC..10T3..
C6-SRSCR-45065-12	00094324	C6	63,0	2.480	45,0	1.772	65,0	2.559	121,0	4.764	165,0	6.496	45,0	0,0	0,0	1,2	2.650	RC..1204..
C6-SRSL-45065-12	00094320	C6	63,0	2.480	45,0	1.772	65,0	2.559	121,0	4.764	165,0	6.496	45,0	0,0	0,0	1,2	2.650	RC..1204..
C6-SRSCR-45065-16	00094325	C6	63,0	2.480	45,0	1.772	65,0	2.559	140,0	5.512	165,0	6.496	45,0	0,0	0,0	1,2	2.650	RC..1606..
C6-SRSL-45065-16	00094321	C6	63,0	2.480	45,0	1.772	65,0	2.559	140,0	5.512	165,0	6.496	45,0	0,0	0,0	1,2	2.650	RC..1606..

Spare Parts

For size	Coolant nozzle	Insert key	Insert screw	Insert shim	Shim screw
					
-06	CN7	T07P-2	C02506-T07P	-	-
-08	CN7	T09P-2	C03007-T09P	-	-
-10	CN7	T15P-2	C03510-T15P	111.19-620	CA3507
-12	CN7	T15P-2	C03512-T15P	111.19-621	CA3507
-16	CN7	T20P-7	C05013-T20P	SRN160400	CA5010

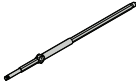
Accessories

For size	Insert clamping torque	Replacement blade	Shim key	Torque key
				
-06	0.9NM	T00-07P	-	T00-07P09
-08	2.0NM	T00-09P	-	T00-09P20
-10	3.0NM	T00-15P	9/64SMS875	T00-15P30
-12	3.0NM	T00-15P	9/64SMS875	T00-15P30
-16	5.0NM	T00-20P	5SMS795	T00-20P50

General ISO Turning
Holders

Steadyline®

MDT

Mini-Shaft™

Grooving

Parting-off

X4

Adapters
Clamping units

Accessories and
Spare parts

Workpiece
materials

C.-SVHBR/L – Toolholders for inserts VBGT, VBGW, VBMT, VBMTW and VCGT – Metric/ Inch

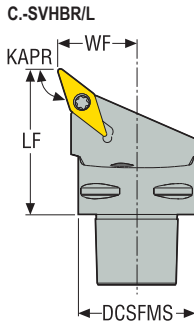

C.-SVHBR/L
KAPR = 107,5°

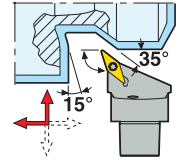

CTWS



- For inserts program, see page(s) 563, 564, 564, 594, 602
- GAMO° = Rake angle, LAMS° = Inclination angle
- CTMS = Seco-Capto™ size
- CTWS = Insert shape and size
- For holder code key, see page(s) 11-12
- Right-hand version shown
- Please check availability at www.secotools.com / Seco Online Store

Designation	Item number	CTMS	DCSFMS		WF	LF	DCINN	DCINN3	KAPR°	GAMO°	LAMS°	Weight	CTWS			
			mm	Inch	mm	Inch	mm	Inch						mm	Inch	kg
C4-SVHBR-27050-11	00094226	C4	40,0	1.575	27,0	1.063	50,0	1.969	–	–	107,5	0,0	0,0	0,4	0.880	VB..1102.. VB..21.5.
C4-SVHBL-27050-11	00094224	C4	40,0	1.575	27,0	1.063	50,0	1.969	–	–	107,5	0,0	0,0	0,4	0.880	VB..1102.. VB..21.5.
C4-SVHBR-27050-16	75065644	C4	40,0	1.575	27,0	1.063	50,0	1.969	95,0	165,0	107,5	0,0	0,0	0,4	0.880	VB..VC..1604 VB..VC..33.
C4-SVHBL-27050-16	00094225	C4	40,0	1.575	27,0	1.063	50,0	1.969	95,0	165,0	107,5	0,0	0,0	0,4	0.880	VB..VC..1604 VB..VC..33.
C5-SVHBR-35060-16	00094386	C5	50,0	1.969	35,0	1.378	60,0	2.362	95,0	165,0	107,5	0,0	0,0	0,7	1.540	VB..VC..1604 VB..VC..33.
C5-SVHBL-35060-16	00094384	C5	50,0	1.969	35,0	1.378	60,0	2.362	95,0	165,0	107,5	0,0	0,0	0,7	1.540	VB..VC..1604 VB..VC..33.
C6-SVHBR-45065-16	00094330	C6	63,0	2.480	45,0	1.772	65,0	2.559	95,0	165,0	107,5	0,0	0,0	1,2	2.650	VB..VC..1604 VB..VC..33.
C6-SVHBL-45065-16	00094329	C6	63,0	2.480	45,0	1.772	65,0	2.559	95,0	165,0	107,5	0,0	0,0	1,2	2.650	VB..VC..1604 VB..VC..33.

Spare Parts

For size	Coolant nozzle	Insert key	Insert screw	Insert shim	Shim screw
C4, C5..-11	CN7	T07P-2	C02506-T07P	–	–
C4..-16	CN6	T15P-2	C03512-T15P	171.19-620	CA3507
C5, C6..-16	CN7	T15P-2	C03512-T15P	171.19-620	CA3507

Accessories

For size	Insert clamping torque	Replacement blade	Shim key	Torque key
C4, C5..-11	0.9NM	T00-07P	–	T00-07P09
C4..-16	3.0NM	T00-15P	9/64SMS875	T00-15P30
C5, C6..-16	3.0NM	T00-15P	9/64SMS875	T00-15P30

C.-SVJBR/L – Toolholders for inserts VBGT, VBGW, VBMT, VBMT and VCGT – Metric/ Inch



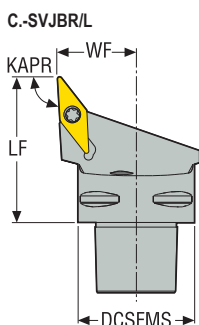
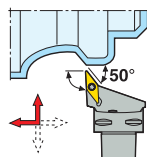













C.-SVJBR/L
KAPR = 93,0°





- For inserts program, see page(s) 563, 564, 564, 594, 602
- GAMO° = Rake angle, LAMS° = Inclination angle
- CTMS = Seco-Capto™ size
- CTWS = Insert shape and size
- For holder code key, see page(s) 11-12
- Right-hand version shown
- Please check availability at www.secotools.com / Seco Online Store

Designation	Item number	CTMS	DCSFMS	WF	LF	DCINN	DCINN3	KAPR°	GAMO°	LAMS°	Weight	CTWS
C3-SVJBR-22040-11	00094146	C3	32,0 1.260	22,0 0.866	40,0 1.575	170,0 6.693	165,0 6.496	93,0	0,0	0,0	0,2 0.440	VB..1102.. VB..21.5.
C3-SVJBL-22040-11	00094145	C3	32,0 1.260	22,0 0.866	40,0 1.575	170,0 6.693	165,0 6.496	93,0	0,0	0,0	0,2 0.440	VB..1102.. VB..21.5.
C4-SVJBR-27050-11	00094230	C4	40,0 1.575	27,0 1.063	50,0 1.969	220,0 8.661	200,0 7.874	93,0	0,0	0,0	0,4 0.880	VB..1102.. VB..21.5.
C4-SVJBL-27050-11	00094227	C4	40,0 1.575	27,0 1.063	50,0 1.969	220,0 8.661	200,0 7.874	93,0	0,0	0,0	0,4 0.880	VB..1102.. VB..21.5.
C4-SVJBR-27050-16	75069318	C4	40,0 1.575	27,0 1.063	50,0 1.969	75,0 2.953	165,0 6.496	93,0	0,0	0,0	0,4 0.880	VB..1102.. VB..21.5.
C4-SVJBL-27050-16	75068368	C4	40,0 1.575	27,0 1.063	50,0 1.969	75,0 2.953	165,0 6.496	93,0	0,0	0,0	0,4 0.880	VB..1102.. VB..21.5.
C5-SVJBR-35060-16	75029329	C5	50,0 1.969	35,0 1.378	60,0 2.362	95,0 3.740	165,0 6.496	93,0	0,0	0,0	0,7 1.540	VB..VC..1604 VB..VC..33.
C5-SVJBL-35060-16	00094388	C5	50,0 1.969	35,0 1.378	60,0 2.362	95,0 3.740	165,0 6.496	93,0	0,0	0,0	0,7 1.540	VB..VC..1604 VB..VC..33.
C6-SVJBR-45065-16	00094332	C6	63,0 2.480	45,0 1.772	65,0 2.559	121,0 4.764	165,0 6.496	93,0	0,0	0,0	1,1 2.430	VB..VC..1604 VB..VC..33.
C6-SVJBL-45065-16	00094331	C6	63,0 2.480	45,0 1.772	65,0 2.559	121,0 4.764	165,0 6.496	93,0	0,0	0,0	1,1 2.430	VB..VC..1604 VB..VC..33.

Spare Parts

For size	Coolant nozzle	Insert key	Insert screw	Insert shim	Shim screw
C3..-11	 CN6	 T07P-2	 C02506-T07P	-	-
C4, C5..-11	 CN7	 T07P-2	 C02506-T07P	-	-
C4..-16	 CN6	 T15P-2	 C03512-T15P	 171.19-620	 CA3507
C5, C6..-16	 CN7	 T15P-2	 C03512-T15P	 171.19-620	 CA3507

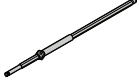
Accessories

For size	Insert clamping torque 	Replacement blade 	Shim key 	Torque key 
C3..-11	0.9NM	T00-07P	-	T00-07P09
C4, C5..-11	0.9NM	T00-07P	-	T00-07P09
C4..-16	3.0NM	T00-15P	9/64SMS875	T00-15P30
C5, C6..-16	3.0NM	T00-15P	9/64SMS875	T00-15P30

General ISO Turning
Holders

Steadyline®

MDT

Mini-Shaft™

Grooving

Parting-off

X4

Adapters
Clamping units

Accessories and
Spare parts

Workpiece
materials

C.-SVVBN – Toolholders for inserts VBGT, VBGW, VBMT, VBMTW and VCGT – Metric/ Inch



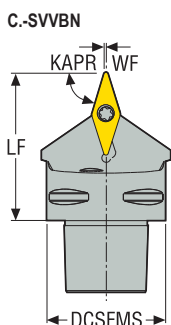
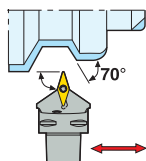





C.-SVVBN
KAPR = 72,5°



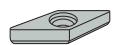



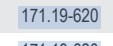

- For inserts program, see page(s) 563, 564, 564, 594, 602
- GAMO° = Rake angle, LAMS° = Inclination angle
- CTMS = Seco-Capto™ size
- CTWS = Insert shape and size
- For holder code key, see page(s) 11-12
- Neutral version shown
- Please check availability at www.secotools.com / Seco Online Store

Designation	Item number	CTMS	DCSFMS	WF	LF	DCINN	DCINN3	KAPR°	GAMO°	LAMS°	Weight	CTWS
C4-SVVBN-00050-16	75069505	C4	40,0 1.575	0,6 0.024	50,0 1.969	-	165,0 6.496	72,5	0,0	0,0	0,4 0.880	VB../VC../1604 VB../VC../33.
C5-SVVBN-00060-16	00094309	C5	50,0 1.969	0,6 0.024	60,0 2.362	-	165,0 6.496	72,5	0,0	0,0	0,7 1.540	VB../VC../1604 VB../VC../33.
C6-SVVBN-00065-16	00094339	C6	63,0 2.480	0,6 0.024	65,0 2.559	-	165,0 6.496	72,5	0,0	0,0	1,1 2.430	VB../VC../1604 VB../VC../33.

Spare Parts

For size	Coolant nozzle	Insert key	Insert screw	Insert shim	Shim screw
C4..-16	 CN6	 T15P-2	 C03512-T15P	 171.19-620	 CA3507
C5, C6..-16	 CN7	 T15P-2	 C03512-T15P	 171.19-620	 CA3507

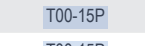
Accessories

For size	Insert clamping torque	Replacement blade	Shim key	Torque key
C4..-16	 3.0NM	 T00-15P	 9/64SMS875	 T00-15P30
C5, C6..-16	 3.0NM	 T00-15P	 9/64SMS875	 T00-15P30

C.-CCLNR/L – Toolholders for PCBN inserts CNGN and CNMN – Metric/ Inch

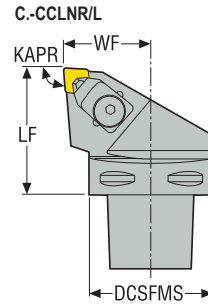
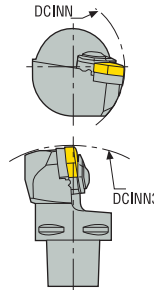

C.-CCLNR/L
KAPR = 95,0 °

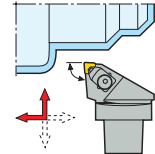

CTWS



- For inserts program, see page(s) 577, 603
- GAMO° = Rake angle, LAMS° = Inclination angle
- CTMS = Seco-Capto™ size
- CTWS = Insert shape and size
- For holder code key, see page(s) 11-12
- Right-hand version shown
- Please check availability at www.secotools.com / Seco Online Store

Designation	Item number	CTMS	DCSFMS		WF		LF		DCINN	DCINN3	KAPR°	GAMO°	LAMS°	Weight	CTWS		
			mm	Inch	mm	Inch	mm	Inch								mm	Inch
C4-CCLNR-27050-09	00042706	C4	40,0	1.575	27,0	1.063	50,0	1.969	75,0	2.953	165,0	6.496	95,0	-6,0	-6,0	0,5 1.100	CN..0903.. CN.N32.
C4-CCLNL-27050-09	00042704	C4	40,0	1.575	27,0	1.063	50,0	1.969	75,0	2.953	165,0	6.496	95,0	-6,0	-6,0	0,5 1.100	CN..0903.. CN.N32.
C4-CCLNR-27050-12	00042743	C4	40,0	1.575	27,0	1.063	50,0	1.969	75,0	2.953	165,0	6.496	95,0	-6,0	-6,0	0,5 1.100	CN..1204.. CN..43.
C4-CCLNL-27050-12	00042707	C4	40,0	1.575	27,0	1.063	50,0	1.969	75,0	2.953	165,0	6.496	95,0	-6,0	-6,0	0,5 1.100	CN..1204.. CN..43.
C5-CCLNR-35060-09	00042745	C5	50,0	1.969	35,0	1.378	60,0	2.362	95,0	3.740	165,0	6.496	95,0	-6,0	-6,0	0,8 1.760	CN..0903.. CN.N32.
C5-CCLNL-35060-09	00042744	C5	50,0	1.969	35,0	1.378	60,0	2.362	95,0	3.740	165,0	6.496	95,0	-6,0	-6,0	0,8 1.760	CN..0903.. CN.N32.
C5-CCLNR-35060-12	00042747	C5	50,0	1.969	35,0	1.378	60,0	2.362	95,0	3.740	165,0	6.496	95,0	-6,0	-6,0	0,8 1.760	CN..1204.. CN..43.
C5-CCLNL-35060-12	00042746	C5	50,0	1.969	35,0	1.378	60,0	2.362	95,0	3.740	165,0	6.496	95,0	-6,0	-6,0	0,8 1.760	CN..1204.. CN..43.
C6-CCLNR-45065-12	00042752	C6	63,0	2.480	45,0	1.772	65,0	2.559	121,0	4.764	165,0	6.496	95,0	-6,0	-6,0	1,3 2.870	CN..1204.. CN..43.
C6-CCLNL-45065-12	00042750	C6	63,0	2.480	45,0	1.772	65,0	2.559	121,0	4.764	165,0	6.496	95,0	-6,0	-6,0	1,3 2.870	CN..1204.. CN..43.

Spare Parts

For size	Cantilever clamp	Clamp key	Coolant nozzle	Insert shim	Pressure plate	Shim screw
C4...09	CC17P-09	4SMS795	CN6	CCN090412	P1311-09	174.10-652-T07P
C4...12	CC17P	4SMS795	CN6	CCN120312	P1311	F94009-T09P
C5...09	CC17P-09	4SMS795	CN8	CCN090412	P1311-09	174.10-652-T07P
C5, C6...12	CC17P	4SMS795	CN8	CCN120312	P1311	F94009-T09P

Accessories

For size	Shim key
	
C4..-09	T07P-2
C4..-12	T09P-2
C5..-09	T07P-2
C5, C6..-12	T09P-2

General ISO Turning
Holders

Steadyline®

MDT

Mini-Shaft™

Grooving

Parting-off

X4

Adapters
Clamping units

Accessories and
Spare parts

Workpiece
materials

C.-CRSNR/L – Toolholders for PCBN inserts RGN and RNMN – Metric/ Inch

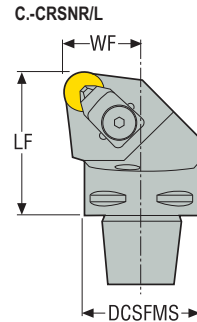
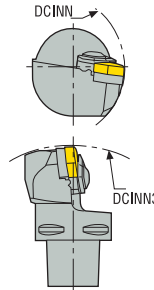

C.-CRSNR/L
KAPR = 45,0 °

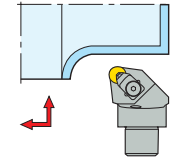

CTWS



- For inserts program, see page(s) 582, 601, 604
- GAMO° = Rake angle, LAMS° = Inclination angle
- CTMS = Seco-Capto™ size
- CTWS = Insert shape and size
- For holder code key, see page(s) 11-12
- Shim 117.10-621 for insert RN.N1204... to be ordered separately
- Right-hand version shown
- Please check availability at www.secotools.com / Seco Online Store

Designation	Item number	CTMS	DCSFMS	WF	LF	DCINN	DCINN3	KAPR°	GAMO°	LAMS°	Weight	CTWS
			mm Inch	mm Inch	mm Inch	mm Inch	mm Inch				kg lbs	
C4-CRSNR-27050-09	00042755	C4	40,0 1.575	27,0 1.063	50,0 1.969	75,0 2.953	165,0 6.496	45,0	0,0	-8,0	0,5 1.100	RN..0903.. RN.32.
C4-CRSNL-27050-09	00042754	C4	40,0 1.575	27,0 1.063	50,0 1.969	75,0 2.953	165,0 6.496	45,0	0,0	-8,0	0,5 1.100	RN..0903.. RN.32.
C4-CRSNR-27050-12	00042758	C4	40,0 1.575	27,0 1.063	50,0 1.969	75,0 2.953	165,0 6.496	45,0	0,0	-8,0	0,5 1.100	RN..1203.. RN..42.
C5-CRSNR-35060-09	00042762	C5	50,0 1.969	35,0 1.378	60,0 2.362	95,0 3.740	165,0 6.496	45,0	0,0	-8,0	0,8 1.760	RN..0903.. RN.32.
C5-CRSNL-35060-09	00042761	C5	50,0 1.969	35,0 1.378	60,0 2.362	95,0 3.740	165,0 6.496	45,0	0,0	-8,0	0,8 1.760	RN..0903.. RN.32.
C5-CRSNR-35060-12	00042764	C5	50,0 1.969	35,0 1.378	60,0 2.362	95,0 3.740	165,0 6.496	45,0	0,0	-8,0	0,8 1.760	RN..1203.. RN..42.
C5-CRSNL-35060-12	00042763	C5	50,0 1.969	35,0 1.378	60,0 2.362	95,0 3.740	165,0 6.496	45,0	0,0	-8,0	0,8 1.760	RN..1203.. RN..42.
C6-CRSNR-45065-09	00042766	C6	63,0 2.480	45,0 1.772	65,0 2.559	121,0 4.764	165,0 6.496	45,0	0,0	-8,0	1,3 2.870	RN..0903.. RN.32.
C6-CRSNL-45065-09	00042765	C6	63,0 2.480	45,0 1.772	65,0 2.559	121,0 4.764	165,0 6.496	45,0	0,0	-8,0	1,3 2.870	RN..0903.. RN.32.
C6-CRSNR-45065-12	00042768	C6	63,0 2.480	45,0 1.772	65,0 2.559	121,0 4.764	165,0 6.496	45,0	0,0	-8,0	1,3 2.870	RN..1203.. RN..42.
C6-CRSNL-45065-12	00042767	C6	63,0 2.480	45,0 1.772	65,0 2.559	121,0 4.764	165,0 6.496	45,0	0,0	-8,0	1,3 2.870	RN..1203.. RN..42.

Spare Parts

For size	Cantilever clamp	Clamp key	Coolant nozzle	Insert shim	Pressure plate	Shim screw
C4..09	 CC17P-09	 4SMS795	 CN6	 117.10-620	 P1311-09	 174.10-652-T07P
C4..12	CC17P	4SMS795	CN6	117.10-622	P1311	F94009-T09P
C5..09	CC17P-09	4SMS795	CN7	117.10-620	P1311-09	174.10-652-T07P
C5..12	CC17P	4SMS795	CN7	117.10-622	P1311	F94009-T09P
C6..09	CC17P-09	4SMS795	CN8	117.10-620	P1311-09	174.10-652-T07P
C6..12	CC17P	4SMS795	CN8	117.10-622	P1311	F94009-T09P

Accessories

For size	Shim key
	
C4..-09	T07P-2
C4..-12	T09P-2
C5..-09	T07P-2
C5..-12	T09P-2
C6..-09	T07P-2
C6..-12	T09P-2

- General ISO Turning Holders
- Steadyline®
- MDT
- Mini-Shaft™
- Grooving
- Parting-off
- X4
- Adapters Clamping units
- Accessories and Spare parts
- Workpiece materials

C.-CSDNN – Toolholders for PCBN inserts SNGN, SNMN and SNUN – Metric/ Inch

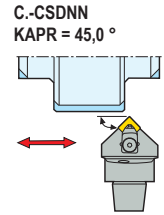
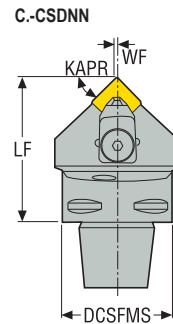
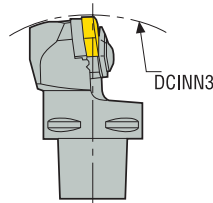

CTWS



- For inserts program, see page(s) 554, 586
- GAMO° = Rake angle, LAMS° = Inclination angle
- CTMS = Seco-Capto™ size
- CTWS = Insert shape and size
- For holder code key, see page(s) 11-12
- Shim 174.10-622 for insert SN.N1203..., to be ordered separately
- Neutral version shown
- Please check availability at www.secotools.com / Seco Online Store

Designation	Item number	CTMS	DCSFMS	WF	LF	DCINN	DCINN3	KAPR°	GAMO°	LAMS°	Weight	CTWS
			mm Inch	mm Inch	mm Inch	mm Inch	mm Inch				kg lbs	
C5-CSDNN-00060-09	00042772	C5	50,0 1.969	0,3 0.012	60,0 2.362	165,0 6.496	165,0 6.496	45,0	-6,0	-6,0	0,7 1.540	SN..0903.. SN..32
C5-CSDNN-00060-12	00042773	C5	50,0 1.969	0,3 0.012	60,0 2.362	165,0 6.496	165,0 6.496	45,0	-6,0	-6,0	0,7 1.540	SN..1204.. SN..43
C6-CSDNN-00065-12	00042774	C6	63,0 2.480	0,3 0.012	65,0 2.559	165,0 6.496	165,0 6.496	45,0	-6,0	-6,0	1,2 2.650	SN..1204.. SN..43

Spare Parts

For size	Cantilever clamp	Clamp key	Coolant nozzle	Insert shim	Pressure plate	Shim screw
-09	 CC17P-09	 4SMS795	 CN6	 CSN090412	 P1311-09	 174.10-652-T07P
-12	 CC20P	 4SMS795	 CN6	 174.10-621	 P1311	 F94009-T09P

Accessories

For size	Shim key
-09	 T07P-2
-12	 T09P-2

General ISO Turning Holders
Steadyline®
MDT
Mini-Shaft™
Grooving
Parting-off
X4
Adapters Clamping units
Accessories and Spare parts
Workpiece materials

C.-CSRNR/L – Toolholders for PCBN inserts SNGN, SNMN and SNUN – Metric/ Inch

C.-CSRNR/L
KAPR = 75,0°

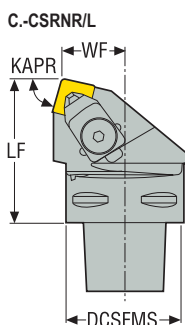
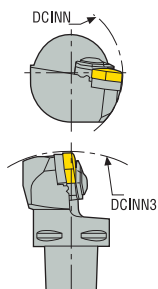
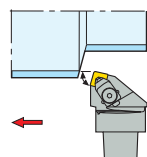





CTWS



- For inserts program, see page(s) 554, 586
- GAMO° = Rake angle, LAMS° = Inclination angle
- CTMS = Seco-Capto™ size
- CTWS = Insert shape and size
- For holder code key, see page(s) 11-12
- Shim 174.10-622 for insert SN.N1203.., to be ordered separately
- Right-hand version shown
- Please check availability at www.secotools.com / Seco Online Store

Designation	Item number	CTMS	DCSFMS	WF	LF	DCINN	DCINN3	KAPR°	GAMO°	LAMS°	Weight	CTWS
C4-CSRNR-22050-09	00042788	C4	40,0 1.575	22,0 0.866	50,0 1.969	75,0 2.953	165,0 6.496	75,0	-6,0	-6,0	0,4 0.880	SN..0903.. SN..32
C4-CSRNL-22050-09	00042787	C4	40,0 1.575	22,0 0.866	50,0 1.969	75,0 2.953	165,0 6.496	75,0	-6,0	-6,0	0,4 0.880	SN..0903.. SN..32
C5-CSRNR-27060-09	00042792	C5	50,0 1.969	27,0 1.063	60,0 2.362	95,0 3.740	165,0 6.496	75,0	-6,0	-6,0	0,8 1.760	SN..0903.. SN..32
C5-CSRNL-27060-09	00042791	C5	50,0 1.969	27,0 1.063	60,0 2.362	95,0 3.740	165,0 6.496	75,0	-6,0	-6,0	0,8 1.760	SN..0903.. SN..32
C6-CSRNR-35065-12	00042796	C6	63,0 2.480	35,0 1.378	65,0 2.559	121,0 4.764	165,0 6.496	75,0	-6,0	-6,0	1,4 3.090	SN..1204.. SN..43
C6-CSRNL-35065-12	00042795	C6	63,0 2.480	35,0 1.378	65,0 2.559	121,0 4.764	165,0 6.496	75,0	-6,0	-6,0	1,4 3.090	SN..1204.. SN..43

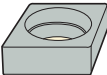
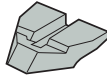
Spare Parts

For size	Cantilever clamp	Clamp key	Coolant nozzle	Insert shim	Pressure plate	Shim screw
-09	 CC17P-09	 4SMS795	 CN6	 CSN090412	 P1311-09	 174.10-652-T07P
C5, C6..-12	CC20P	4SMS795	CN8	174.10-621	P1311	F94009-T09P

Accessories

For size	Shim key
-09	 T07P-2
C5, C6..-12	T09P-2

C.-CTJNR/L – Toolholders for PCBN inserts TNGN, TNGX, TNMN and TNMX – Metric/ Inch

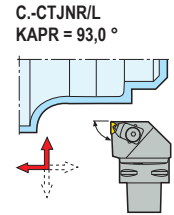
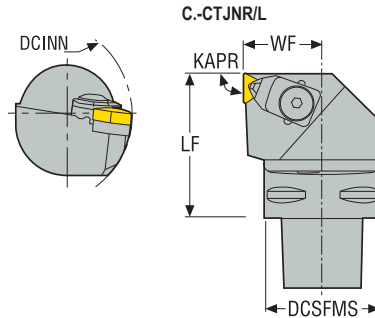

CTWS



- For inserts program, see page(s) 558, 559, 560, 561, 591
- GAMO° = Rake angle, LAMS° = Inclination angle
- CTMS = Seco-Capto™ size
- CTWS = Insert shape and size
- For holder code key, see page(s) 11-12
- Right-hand version shown
- Please check availability at www.secotools.com / Seco Online Store

Designation	Item number	CTMS	DCSFMS	WF	LF	DCINN	DCINN3	KAPR°	GAMO°	LAMS°	Weight	CTWS
C4-CTJNR-27050-11	02545416	C4	40,0 1.575	27,0 1.063	50,0 1.969	75,0 2.953	75,0 2.953	93,0	-6,0	-6,0	0,5 1.100	TN..1103.. TN..22.
C4-CTJNL-27050-11	02508823	C4	40,0 1.575	27,0 1.063	50,0 1.969	75,0 2.953	75,0 2.953	93,0	-6,0	-6,0	0,5 1.100	TN..1103.. TN..22.
C5-CTJNL-35060-11	02595995	C5	50,0 1.969	35,0 1.378	60,0 2.362	95,0 3.740	95,0 3.740	93,0	-6,0	-6,0	1,0 2.200	TN..1103.. TN..22.

Spare Parts

For size	Cantilever clamp	Clamp key	Coolant nozzle	Insert shim	Pressure plate	Shim screw
C4..-11	CC17P-06	4SMS795	CN6	CTN110308	P1311-06	CS2507-T07P
C5, C6..-11	CC17P-06	4SMS795	CN8	CTN110308	P1311-06	CS2507-T07P

Accessories

For size	Shim key
C4..-11	T07P-2
C5, C6..-11	T07P-2

General ISO Turning Holders
Steadyline®
MDT
Mini-Shaft™
Grooving
Parting-off
X4
Adapters Clamping units
Accessories and Spare parts
Workpiece materials

C.-CRSNR/L-..C – Toolholders for ceramic inserts RNGN – Metric/ Inch

C.-CRSNR/L-..C
KAPR = 0,0 °

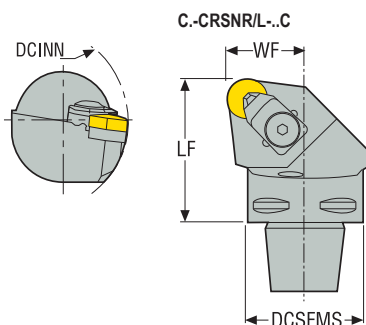
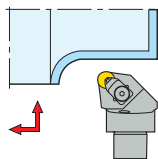













CTWS

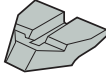

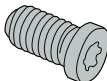

- For inserts program, see page(s) 582, 601, 604
- GAMO° = Rake angle, LAMS° = Inclination angle
- CTMS = Seco-Capto™ size
- CTWS = Insert shape and size
- For holder code key, see page(s) 11-12
- Right-hand version shown
- Please check availability at www.secotools.com / Seco Online Store

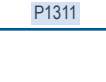
Designation	Item number	CTMS	DCSFMS	WF	LF	DCINN	DCINN3	KAPR°	GAMO°	LAMS°	Weight	CTWS
C5-CRSNR-35060-12C	02926924	C5	50,0 1.969	35,0 1.378	60,0 2.362	250,0 9.843	–	0,0	-6,0	-6,0	0,9 1.980	RN..1207.. RN..45.
C5-CRSNL-35060-12C	02926925	C5	50,0 1.969	35,0 1.378	60,0 2.362	250,0 9.843	–	0,0	-6,0	-6,0	0,9 1.980	RN..1207.. RN..45.
C6-CRSNR-45065-12C	02926926	C6	63,0 2.480	45,0 1.772	65,0 2.559	325,0 12.795	–	0,0	-6,0	-6,0	1,5 3.310	RN..1207.. RN..45.
C6-CRSNL-45065-12C	02926927	C6	63,0 2.480	45,0 1.772	65,0 2.559	325,0 12.795	–	0,0	-6,0	-6,0	1,4 3.090	RN..1207.. RN..45.

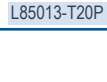
Spare Parts

For size	Clamp	Clamp key	Coolant nozzle	Insert shim	Pressure plate	Shim key	Shim screw
C5-..-12C	 CC17P	 4SMS795	 CN2	 CRN120400	 P1311	 T20P-2D	 L85013-T20P
C6-..-12C	 CC17P	 4SMS795	 CN2	 CRN120400	 P1311	 T20P-2D	 L85013-T20P

Accessories

For size	Insert shim
C5-..-12C	 CRN120800
C6-..-12C	 CRN120800

General ISO Turning
Holders

Steadyline®

MDT

Mini-Shaft™

Grooving

Parting-off

X4

Adapters
Clamping units

Accessories and
Spare parts

Workpiece
materials

C-CXXXR/L – Toolholders for cassettes – Metric/ Inch

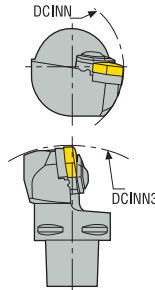

- GAMO° = Rake angle, LAMS° = Inclination angle
- CTMS = Seco-Capto™ size
- For holder code key, see page(s) 11-12
- Right-hand version shown
- Please check availability at www.secotools.com / Seco Online Store

Designation	Item number	CTMS	DCSFMS	WF	LF	DCINN	DCINN3	GAMO°	LAMS°	Weight
			mm Inch	mm Inch	mm Inch	mm Inch	mm Inch			kg lbs
C5-CXXXR-35060-CT10	03300014	C5	50,0 1.969	18,0 0.709	43 1.691	95,0 3.740	170,0 6.693	-6,0	-6,0	0,7 1.540
C5-CXXXL-35060-CT10	03300009	C5	50,0 1.969	18,0 0.709	43 1.691	95,0 3.740	170,0 6.693	-6,0	-6,0	0,7 1.540
C6-CXXXR-45065-CT10	03300016	C6	63,0 2.480	28,0 1.103	48 1.888	120,0 4.724	180,0 7.087	-6,0	-6,0	1,2 2.650
C6-CXXXL-45065-CT10	03300015	C6	63,0 2.480	28,0 1.103	48 1.888	120,0 4.724	180,0 7.087	-6,0	-6,0	1,2 2.650

Spare Parts

For size	Cantilever clamp	Cassette screw	Clamp key	Coolant nozzle	Key (L-style)	Pressure plate
C5	CC17P	C05013-T20P	4SMS795	CN6	T20P-7L	P1311
C6	CC17P	C05013-T20P	4SMS795	CN8	T20P-7L	P1311

Accessories

For size	Insert clamping torque	Torque key
C5	6.0NM	T00T-20P60
C6	6.0NM	T00T-20P60

General ISO Turning Holders
Steadyline®
MDT
Mini-Shaft™
Grooving
Parting-off
X4
Adapters Clamping units
Accessories and Spare parts
Workpiece materials

CT-CCLNX – Cassettes for Seco-Capto™ holders – Metric/ Inch

KAPR = 95,0°

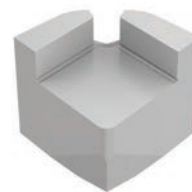
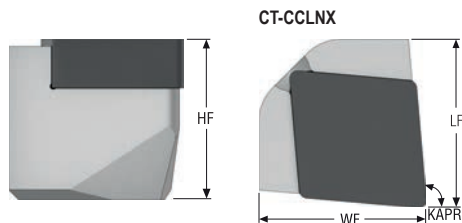
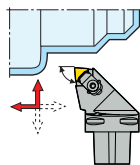

CTWS



- For inserts program, see page(s) 577, 603
- GAMO° = Rake angle, LAMS° = Inclination angle
- CTWS = Insert shape and size
- For holder code key, see page(s) 11-12
- Please check availability at www.secotools.com / Seco Online Store

Designation	Item number	CT size	WF	LF	HF	KAPR°	Weight	CTWS
			mm Inch	mm Inch	mm Inch		kg lbs	
CT10-CCLNX-0903 CT10-CCLNX-32	03300028	CT10	17,0 0.669	17 0.669	15,5 0.611	95,0	0,1 0.220	CN.N0903 CN.N32.
CT10-CCLNX-1204 CT10-CCLNX-43	03300023	CT10	17,0 0.669	17 0.669	15,5 0.611	95,0	0,1 0.220	CN.N1204 CN.N43.
CT10-CCLNX-1207 CT10-CCLNX-45	03300024	CT10	17,0 0.669	17 0.669	15,5 0.611	95,0	0,1 0.220	CN.N1207.. CN.N45.

General ISO Turning
Holders

Steadyline®

MDT

Mini-Shaft™

Grooving

Parting-off

X4

Adapters
Clamping units

Accessories and
Spare parts

Workpiece
materials

CT-CRSNX – Cassettes for Seco-Capto™ holders – Metric/ Inch

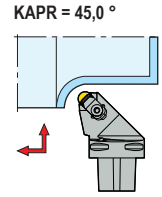
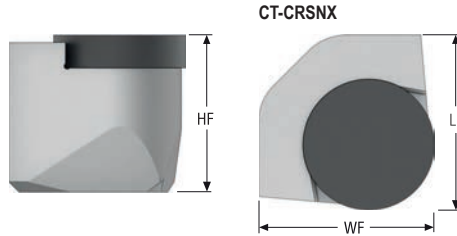
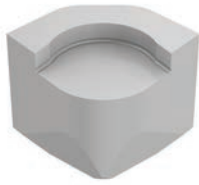

CTWS



- For inserts program, see page(s) 582, 601, 604
- GAMO° = Rake angle, LAMS° = Inclination angle
- CTWS = Insert shape and size
- For holder code key, see page(s) 11-12
- Please check availability at www.secotools.com / Seco Online Store

Designation	Item number	CT size	WF	LF	HF	KAPR°	Weight	CTWS
			mm <i>Inch</i>	mm <i>Inch</i>	mm <i>Inch</i>			
CT10-CRSNX-0903 CT10-CRSNX-32	03300029	CT10	17,0 0.669	17 0.669	15,2 0.598	45,0	0,1 0.220	RN.N0903.. RN.N32
CT10-CRSNX-1203 CT10-CRSNX-42	03300025	CT10	17,0 0.669	17 0.669	15,2 0.598	45,0	0,1 0.220	RN.N1203.. RN.N42
CT10-CRSNX-1204 CT10-CRSNX-43	03300026	CT10	17,0 0.669	17 0.669	15,2 0.598	45,0	0,1 0.220	RN.N1204.. RN.N43
CT10-CRSNX-1207 CT10-CRSNX-45	03300027	CT10	17,0 0.669	17 0.669	15,2 0.598	45,0	0,1 0.220	RN.N1207.. RN.N45

General ISO Turning Holders
Steadyline®
MDT
Mini-Shaft™
Grooving
Parting-off
X4
Adapters Clamping units
Accessories and Spare parts
Workpiece materials

C.-DCMNN..-M – Toolholders for inserts CNGA, CNGG, CNMA, CNMG and CNMM – Metric / Inch

C.-DCMNN..-M
KAPR = 50,0°

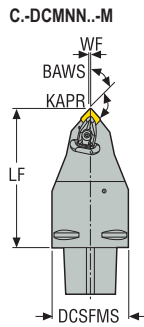
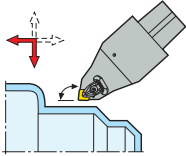

- For inserts program, see page(s) 527, 528, 529, 530, 531, 532, 533, 575, 576
- GAMO° = Rake angle, LAMS° = Inclination angle
- CTMS = Seco-Capto™ size
- CTWS = Insert shape and size
- For holder code key, see page(s) 11-12
- Neutral version shown
- Please check availability at www.secotools.com / Seco Online Store

Designation	Item number	CTMS	DCSFMS		LF	KAPR°	BAWS°	GAMO°	LAMS°	Weight		CTWS
			mm	Inch						kg	lbs	
C6-DCMNN-00090-12-M	02588065	C6	63,0	0,0	90	50,0	45,0	-6,0	-6,0	1,3	2,870	CN..1204.. CN..43.
C6-DCMNN-00115-12-M	02588066	C6	63,0	0,0	115	50,0	45,0	-6,0	-6,0	2,1	4,630	CN..1204.. CN..43.

Spare Parts

For size	Clamp pin	Clamp screw	Coolant nozzle	Floating wedge clamp	Insert shim	Shim/clamp key	Shim screw	Spring
00090-12	FP2012	L85021-T15P	CN6	CD12-S	DCN120616	T15P-2	C04008-T15P	S6912
00115-12	FP2012	L85021-T15P	CN8	CD12-S	DCN120616	T15P-2	C04008-T15P	S6912

Accessories

For size	Clamp kit	Insert clamping torque	Replacement blade	Torque key
00090-12	CD12-S12	3.5NM	T00-15P	T00-15P35
00115-12	CD12-S12	3.5NM	T00-15P	T00-15P35

General ISO Turning Holders
Steadyline®
MDT
Mini-Shaft™
Grooving
Parting-off
X4
Adapters Clamping units
Accessories and Spare parts
Workpiece materials

C.-DDMNL – Toolholders for inserts DNGA, DNGG, DNGM, DNMA, DNMG, DNMM and DNMX – Metric/ Inch

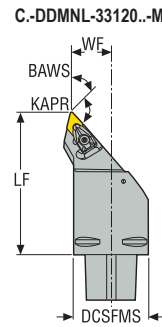
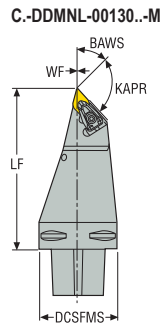

C.-DDMNL..-M
KAPR = 50,0 °

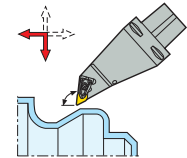

C.-DDMNL..-M
KAPR = 93,0 °

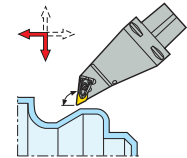

CTWS



- For inserts program, see page(s) 537, 538, 539, 540, 541, 579, 580, 598
- GAMO° = Rake angle, LAMS° = Inclination angle
- CTMS = Seco-Capto™ size
- CTWS = Insert shape and size
- For holder code key, see page(s) 11-12
- Left-hand version shown
- * Use the right shim & the right screw for the selected insert. For details, see page 99
- Please check availability at www.secotools.com / Seco Online Store

Designation	Item number	CTMS	DCSFMS	WF	LF	KAPR°	BAWS°	GAMO°	LAMS°	Weight	CTWS
			mm Inch	mm Inch	mm Inch					kg lbs	
C6-DDMNL-00130-15-M	02588067	C6	63,0 2.480	0,0 0,0	130 5.118	50,0	45,0	-6,0	-6,0	1,5 3.310	DN.1504/DN..1506 DN..43/DN..44*
C6-DDMNL-33120-15-M	02649370	C6	63,0 2.480	33,0 1.299	120 4.724	93,0	45,0	-6,0	-6,0	2,2 4.850	DN.1504/DN..1506 DN..43/DN..44*

Spare Parts

For size	Clamp pin	Clamp screw	Coolant nozzle	Floating wedge clamp	Insert shim	Shim/clamp key	Shim screw	Spring
00130-15	FP2012	L85021-T15P	CN6	CD12-S	DDN150416	T15P-2	C04008-T15P	S6912
33120-15	FP2012	L85021-T15P	CN8	CD12-S	DDN150416	T15P-2	C04008-T15P	S6912

Accessories

For size	Clamp kit	Insert clamping torque	Replacement blade	Torque key
00130-15	CD12-S12	3.5NM	T00-15P	T00-15P35
33120-15	CD12-S12	3.5NM	T00-15P	T00-15P35

General ISO Turning
Holders

Steadyline®

MDT

Mini-Shaft™

Grooving

Parting-off

X4

Adapters
Clamping units

Accessories and
Spare parts

Workpiece
materials

C.-DVMNL..-M – Toolholders for inserts VNGA, VNGG, VNGM, VNMA and VNMG – Metric/ Inch

C.-DVMNL..-M
KAPR = 93,0°

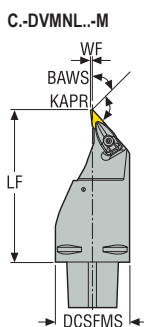
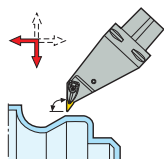

- For inserts program, see page(s) 565, 566, 595
- GAMO° = Rake angle, LAMS° = Inclination angle
- CTMS = Seco-Capto™ size
- CTWS = Insert shape and size
- For holder code key, see page(s) 11-12
- Left-hand version shown
- Please check availability at www.secotools.com / Seco Online Store

Designation	Item number	CTMS	DCSFMS	WF	LF	KAPR°	BAWS°	GAMO°	LAMS°	Weight	CTWS
			mm Inch	mm Inch	mm Inch					kg lbs	
C6-DVMNL-00130-16-M	02588068	C6	63,0 2.480	0,0 0,0	130 5.118	93,0	45,0	-4,5	-13,5	2,1 4.630	VN..1604.. VN..33.

Spare Parts

For size	Clamp pin	Clamp screw	Coolant nozzle	Floating wedge clamp	Insert shim	Shim/clamp key	Shim screw	Spring
...-16	FP2012	L85021-T15P	CN6	CD19-S-V16	DVN160310	T15P-2	C03508-T15P	S6912

Accessories

For size	Clamp kit	Insert clamping torque	Replacement blade	Torque key
...-16	CD19-V16	3.5NM	T00-15P	T00-15P35

General ISO Turning
Holders

Steadyline®

MDT

Mini-Shaft™

Grooving

Parting-off

X4

Adapters
Clamping units

Accessories and
Spare parts

Workpiece
materials

C.-PWLNN – Toolholders for inserts WNGA, WNMA, WNMG and WNMM – Metric / Inch

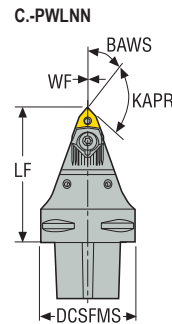

C.-PWLNN
KAPR = 95,0 °

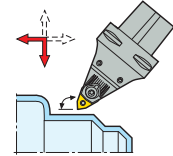

CTWS



- For inserts program, see page(s) 568, 569, 570, 571, 596
- GAMO° = Rake angle, LAMS° = Inclination angle
- CTMS = Seco-Capto™ size
- CTWS = Insert shape and size
- For holder code key, see page(s) 11-12
- Wedge WNW08 for insert WNMM08.., to be ordered separately
- Neutral version shown
- * Use the right shim & the right screw for the selected insert. For details, see page 99
- Please check availability at www.secotools.com / Seco Online Store

Designation	Item number	CTMS	DCSFMS	WF	LF	KAPR°	BAWS°	GAMO°	LAMS°	Weight	CTWS
			mm Inch	mm Inch	mm Inch					kg lbs	
C6-PWLNN-00090-08	02509282	C6	63,0 2.480	0,0 0,0	90 3.543	95,0	45,0	-5,5	-6,5	1,4 3.090	WN..0804/WN..0806 WN..43/WN..44*

Spare Parts

For size	Coolant nozzle	Insert shim	Setting screw	Shim pin	Wedge clamp	Wedge key	Wedge screw
...-08	CN8	WAE080412	L82511-T07P	PP2015-1-T15P	WNW08HD	T25P-7	WS2325-T25P

Accessories

For size	Insert clamping torque	Replacement blade	Shim key	Torque key
...-08	5.0NM	T00T-25P	T15P-2	T00T-25P50

General ISO Turning Holders
Steadyline®
MDT
Mini-Shaft™
Grooving
Parting-off
X4
Adapters Clamping units
Accessories and Spare parts
Workpiece materials

C.-SCMCN – Toolholders for inserts CCGT, CCGW, CCGX, CCMT and CCMW – Metric/ Inch

C.-SCMCN
KAPR = 95,0°

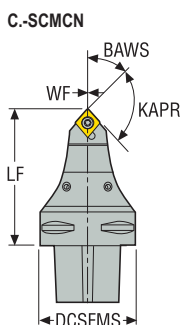
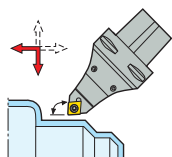

CTWS



- For inserts program, see page(s) 522, 523, 524, 525, 573, 574, 597, 599
- GAMO° = Rake angle, LAMS° = Inclination angle
- CTMS = Seco-Capto™ size
- CTWS = Insert shape and size
- For holder code key, see page(s) 11-12
- Neutral version shown
- Please check availability at www.secotools.com / Seco Online Store

Designation	Item number	CTMS	DCSFMS		LF	KAPR°	BAWS°	GAMO°	LAMS°	Weight		CTWS
			mm	Inch						kg	lbs	
C6-SCMCN-00090-12	02437226	C6	63,0	2,480	90	95,0	45,0	0,0	0,0	1,2	2,650	CC..1204.. CC..43.

Spare Parts

For size	Coolant nozzle	Insert key	Insert screw	Insert shim	Shim screw
...-12	 CN8	 T15P-2	 C05012-T15P	 123.19-621	 CA5008

Accessories

For size	Insert clamping torque	Replacement blade	Shim key	Torque key
...-12	 5.0NM	 T00-15P	 5SMS795	 T00-15P50

General ISO Turning
Holders

Steadyline®

MDT

Mini-Shaft™

Grooving

Parting-off

X4

Adapters
Clamping units

Accessories and
Spare parts

Workpiece
materials

C.-SRDCN – Toolholders for inserts RCMT – Metric/ Inch

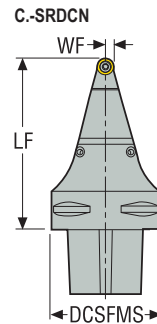

C.-SRDCN
KAPR = 45,0 °

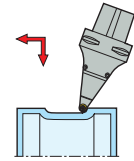

CTWS



- For inserts program, see page(s) 545, 546
- GAMO° = Rake angle, LAMS° = Inclination angle
- CTMS = Seco-Capto™ size
- CTWS = Insert shape and size
- For holder code key, see page(s) 11-12
- Neutral version shown
- Please check availability at www.secotools.com / Seco Online Store

Designation	Item number	CTMS	DCSFMS	WF	LF	KAPR°	BAWS°	GAMO°	LAMS°	Weight	CTWS
			mm Inch	mm Inch	mm Inch					kg lbs	
C6-SRDCN-00100-10	02509285	C6	63,0 2.480	5,0 0.197	100 3.937	45,0	–	0,0	0,0	1,5 3.310	RC..10T3..
C6-SRDCN-00100-16	02509286	C6	63,0 2.480	8,0 0.315	100 3.937	45,0	–	0,0	0,0	1,5 3.310	RC..1606..

Spare Parts

For size	Coolant nozzle	Insert key	Insert screw	Insert shim	Shim screw
...-10	 CN8	 T15P-2	 C03510-T15P	 111.19-620	 CA3510
...-16	 CN8	 T20P-7L	 C05018-T20P	 SRN16T3M0	 CA5015

Accessories

For size	Insert clamping torque	Replacement blade	Shim key	Torque key
...-10	 3.0NM	 T00-15P	 9/64SMS875	 T00-15P30
...-16	 5.0NM	 T00-20P	 5SMS795	 T00-20P50

C.-SVMBL – Toolholders for inserts VBGT, VBGW, VBMT, VBMTW and VCGT – Metric / Inch

C.-SVMBL
KAPR = 95,0°

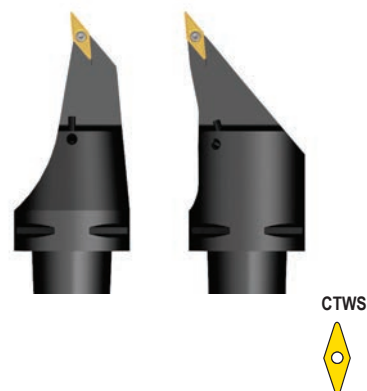
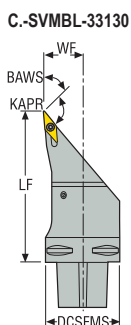
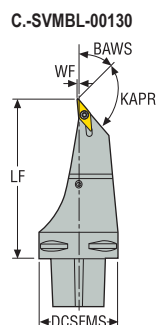
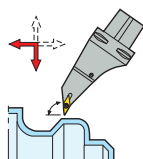

- For inserts program, see page(s) 563, 564, 564, 594, 602
- GAMO° = Rake angle, LAMS° = Inclination angle
- CTMS = Seco-Capto™ size
- CTWS = Insert shape and size
- For holder code key, see page(s) 11-12
- Left-hand version shown
- Please check availability at www.secotools.com / Seco Online Store

Designation	Item number	CTMS	DCSFMS		WF	LF	KAPR°	BAWS°	GAMO°	LAMS°	Weight	CTWS
			mm	Inch	mm	Inch						
C6-SVMBL-00130-16	02509287	C6	63,0	2.480	1,1	130	95,0	45,0	0,0	0,0	1,8	VB../VC..1604 VB../VC..33.
C6-SVMBL-33130-16	02435740	C6	63,0	2.480	33,0	130	95,0	45,0	0,0	0,0	2,1	VB../VC..1604 VB../VC..33.

Spare Parts

For size	Coolant nozzle	Insert key	Insert screw	Insert shim	Shim screw
...-16	CN8	T15P-2	C03512-T15P	171.19-620	CA3510

Accessories

For size	Insert clamping torque	Replacement blade	Shim key	Torque key
...-16	3.0NM	T00-15P	9/64SMS875	T00-15P30

General ISO Turning
Holders

Steadyline®

MDT

Mini-Shaft™

Grooving

Parting-off

X4

Adapters
Clamping units

Accessories and
Spare parts

Workpiece
materials

DCBNR/L...JETI – Toolholders for inserts CNMA, CNMG and CNMM – Metric

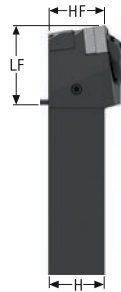
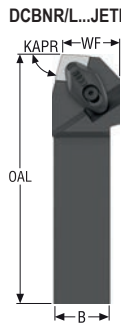

DCBNR/L...JETI
KAPR = 75,0 °

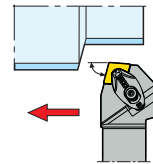

CTWS



- For inserts program, see page(s) 527, 528, 529, 530, 531, 532, 533
- For more information on Jetstream Tooling® (High pressure coolant) and accessories, please see page(s) 38, 85-89, 1002
- GAMO° = Rake angle, LAMS° = Inclination angle
- CTWS = Insert shape and size
- For holder code key, see page(s) 15-16
- For suitable adapter, see page(s) 962-973
- * When using toolholder together with an adapter the maximum coolant pressure might be limited, please see page(s) 85
- ** Jetstream Tooling® Duo, see page(s) 38, 85-89
- For JETI coolant clamp it is recommended to set regular screw and double O-rings exchange rate to keep the safety first and minimize leakage for the application at hand
- Right-hand version shown
- Please check availability at www.secotools.com / Seco Online Store

Designation	Item number	**	H	B	OAL	LF	WF	HF	CP*	KAPR°	GAMO°	LAMS°	Weight	CTWS
			mm	mm	mm	mm	mm	mm	bar				kg	
DCBNR3232X16JETI	03282306	Duo	32	32	145	46	27,0	32,0	200,0	75,0	-6,0	-6,0	1,2	CN..1606..
DCBNL3232X16JETI	03282305	Duo	32	32	145	46	27,0	32,0	200,0	75,0	-6,0	-6,0	1,2	CN..1606..

Spare Parts

For size	Clamp screw	Coolant kit	Insert shim	Plug	Plug screw	Shim/clamp key	Shim screw	Spring
...16	L85021-T15P	CN21L00R-2-SET	DCN160616	JET-P1/8-5MM	P6SS3X3G	T15P-2	C05010-T20P	S7111

Accessories

For size	Duo coolant plug screw	Insert clamping torque	Plug screw JETI	Shim key	Torque key
...16	P6SS3X5	3.5NM	P6SS6X6	T20P-2D	T00-15P35

General ISO Turning Holders
Steadyline®
MDT
Mini-Shaft™
Grooving
Parting-off
X4
Adapters Clamping units
Accessories and Spare parts
Workpiece materials

DCLCR/L...JETI – Toolholders for inserts CCGT, CCGW, CCGX, CCMT and CCMW – Metric

DCLCR/L...JETI
KAPR = 95,0°

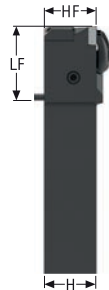
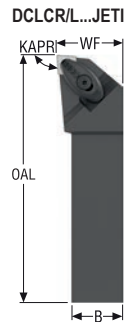
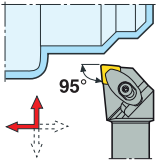

CTWS



- For inserts program, see page(s) 522, 523, 524, 525, 573, 574, 597, 599
- For more information on Jetstream Tooling® (High pressure coolant) and accessories, please see page(s) 38, 85-89, 1002
- GAMO° = Rake angle, LAMS° = Inclination angle
- CTWS = Insert shape and size
- For holder code key, see page(s) 15-16
- For suitable adapter, see page(s) 962-973
- * When using toolholder together with an adapter the maximum coolant pressure might be limited, please see page(s) 85
- ** Jetstream Tooling® Duo, see page(s) 38, 85-89
- For JETI coolant clamp it is recommended to set regular screw and double O-rings exchange rate to keep the safety first and minimize leakage for the application at hand
- Right-hand version shown
- Please check availability at www.secotools.com / Seco Online Store

Designation	Item number	**	H	B	OAL	LF	WF	HF	CP*	KAPR°	GAMO°	LAMS°	Weight	CTWS
			mm	mm	mm	mm	mm	mm	bar				kg	
DCLCR2020X09JETI	03282310	Duo	20	20	100	36	27,0	20,0	200,0	95,0	0,0	0,0	0,4	CC..09T3..
DCLCR2525X09JETI	03282311	Duo	25	25	120	36	32,0	25,0	200,0	95,0	0,0	0,0	0,6	CC..09T3..
DCLCL2020X09JETI	03282307	Duo	20	20	100	36	27,0	20,0	200,0	95,0	0,0	0,0	0,4	CC..09T3..
DCLCL2525X09JETI	03282308	Duo	25	25	120	36	32,0	25,0	200,0	95,0	0,0	0,0	0,6	CC..09T3..
DCLCR2525X12JETI	03282312	Duo	25	25	120	36	32,2	25,0	200,0	95,0	0,0	0,0	0,7	CC..1204..
DCLCL2525X12JETI	03282309	Duo	25	25	120	36	32,2	25,0	200,0	95,0	0,0	0,0	0,6	CC..1204..

Spare Parts

For size	Clamp key	Clamp screw	Coolant kit	Insert shim	Plug	Plug screw	Shim/clamp key	Shim screw	Spring
...09	T09P-2	L84017-T09P	CP14U00S-2-SET	–	JET-P1/8-5MM	P6SS3X3G	–	–	S5808
...12	–	L85021-T15P	CP17U00S-2-SET	123.19-621	JET-P1/8-5MM	P6SS3X3G	T15P-2	CA5008	S7111

Accessories

For size	Duo coolant plug screw	Insert clamping torque	Plug screw JETI	Shim key	Torque key
...09	P6SS3X5	2.0NM	P6SS6X6	–	T00-09P20
...12	P6SS3X5	3.5NM	P6SS6X6	5SMS795	T00-15P35

General ISO Turning Holders
Steadyline®
MDT
Mini-Shaft™
Grooving
Parting-off
X4
Adapters Clamping units
Accessories and Spare parts
Workpiece materials

DCLCR/L...JETI – Toolholders for inserts CCGT, CCGW, CCGX, CCMT and CCMW – Inch

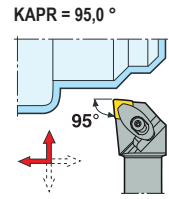
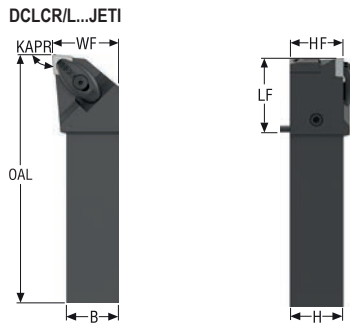
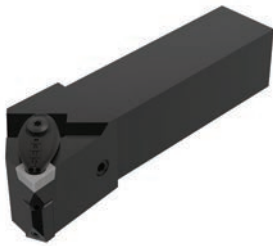

CTWS







- For inserts program, see page(s) 522, 523, 524, 525, 573, 574, 597, 599
- For more information on Jetstream Tooling® (High pressure coolant) and accessories, please see page(s) 38, 85-89, 1002
- GAMO° = Rake angle, LAMS° = Inclination angle
- CTWS = Insert shape and size
- For holder code key, see page(s) 17-18
- For suitable adapter, see page(s) 962-973
- * When using toolholder together with an adapter the maximum coolant pressure might be limited, please see page(s) 85
- ** Jetstream Tooling® Duo, see page(s) 38, 85-89
- For JETI coolant clamp it is recommended to set regular screw and double O-rings exchange rate to keep the safety first and minimize leakage for the application at hand
- Right-hand version shown
- Please check availability at www.secotools.com / Seco Online Store

Designation	Item number	**	H	B	OAL	LF	WF	HF	CP*	KAPR°	GAMO°	LAMS°	Weight	CTWS
			Inch	Inch	Inch	Inch	Inch	Inch	psi				lbs	
DCLCR-12-3XJETI	03282256	Duo	0.750	0.750	3.740	1.220	1.059	0.750	2900.8	95,0	0,0	0,0	1.100	CC..32.5
DCLCR-16-3XJETI	03282257	Duo	1.000	1.000	4.724	1.417	1.260	1.000	2900.8	95,0	0,0	0,0	1.320	CC..32.5
DCLCL-12-3XJETI	03282253	Duo	0.750	0.750	3.740	1.220	1.059	0.750	2900.8	95,0	0,0	0,0	1.100	CC..32.5
DCLCL-16-3XJETI	03282255	Duo	1.000	1.000	4.724	1.417	1.260	1.000	2900.8	95,0	0,0	0,0	1.320	CC..32.5
DCLCR-12-4XJETI	03284736	Duo	0.750	0.750	4.173	1.654	1.059	0.750	2900.8	95,0	0,0	0,0	1.320	CC..43
DCLCR-20-4XJETI	03282258	Duo	1.250	1.250	5.472	1.575	1.500	1.250	2900.8	95,0	0,0	0,0	1.980	CC..43
DCLCL-12-4XJETI	03282254	Duo	0.750	0.750	4.173	1.654	1.059	0.750	2900.8	95,0	0,0	0,0	0.660	CC..43
DCLCL-20-4XJETI	03284737	Duo	1.250	1.250	5.472	1.575	1.500	1.250	2900.8	95,0	0,0	0,0	2.200	CC..43

Spare Parts

For size	Clamp key	Clamp screw	Coolant kit	Insert shim	Plug	Plug screw	Shim screw	Spring
..-12-3	T09P-2	L84017-T09P	CP14U00S-2-SET	-	JET-P1/8-5MM	P6SS3X3G	-	S5808
..-16-3	T09P-2	L84017-T09P	CP14U00S-2-SET	-	JET-P1/8-5MM	P6SS3X3G	-	S5808
..R-12-4	T15P-2	L85021-T15P	CP17U00S-2-SET	123.19-621	JET-P1/8-5MM	P6SS3X3G	CA5008	S7111
..R-20-4	T15P-2	L85021-T15P	CP17U00S-2-SET	123.19-621	JET-P1/8-5MM	P6SS3X3G	-	CA5008
..L-12-4	T15P-2	L85021-T15P	CP17U00S-2-SET	123.19-621	JET-P1/8-5MM	P6SS3X3G	CA5008	S7111
..L-20-4	T15P-2	L85021-T15P	CP17U00S-2-SET	123.19-621	JET-P1/8-5MM	P6SS3X3G	CA5008	S7111

Accessories

For size	Duo coolant plug screw	Insert clamping torque	Plug screw JETI	Shim key	Torque key
..-12-3	 P6SS3X5	 17.7IN.LBS	 P6SS6X6	 -	 T00-09P20
..-16-3	P6SS3X5	17.7IN.LBS	P6SS6X6	-	T00-09P20
..R-12-4	P6SS3X5	31.0IN.LBS	P6SS6X6	5SMS795	T00-15P35
..R-20-4	P6SS3X5	31.0IN.LBS	P6SS6X6	5SMS795	T00-15P35
..L-12-4	P6SS3X5	31.0IN.LBS	P6SS6X6	5SMS795	T00-15P35
..L-20-4	P6SS3X5	31.0IN.LBS	P6SS6X6	5SMS795	T00-15P35

General ISO Turning
Holders

Steadyline®

MDT

Mini-Shaft™

Grooving

Parting-off

X4

Adapters
Clamping units

Accessories and
Spare parts

Workpiece
materials

DCLNR/L...JETI – Toolholders for inserts CNGA, CNGG, CNGM, CNMA, CNMG and CNMM – Metric

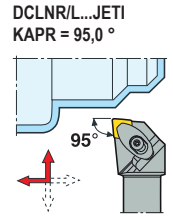
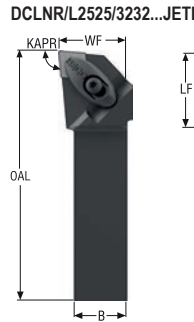
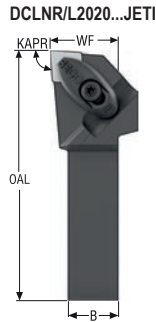

CTWS



- For inserts program, see page(s) 527, 528, 529, 530, 531, 532, 533, 575, 576, 597
- For more information on Jetstream Tooling® (High pressure coolant) and accessories, please see page(s) 38, 85-89, 1002
- GAMO° = Rake angle, LAMS° = Inclination angle
- CTWS = Insert shape and size
- For holder code key, see page(s) 15-16
- For suitable adapter, see page(s) 962-973
- * When using toolholder together with an adapter the maximum coolant pressure might be limited, please see page(s) 85
- ** Jetstream Tooling® Duo, see page(s) 38, 85-89
- For JETI coolant clamp it is recommended to set regular screw and double O-rings exchange rate to keep the safety first and minimize leakage for the application at hand
- Right-hand version shown
- Please check availability at www.secotools.com / Seco Online Store

Designation	Item number	**	H	B	OAL	LF	WF	HF	CP*	KAPR°	GAMO°	LAMS°	Weight	CTWS
			mm	mm	mm	mm	mm	mm	bar				kg	
DCLNR2020X12JETI	03213106	Duo	20	20	100	36	27,2	20,0	200,0	95,0	-6,0	-6,0	0,4	CN..1204..
DCLNR2525X12JETI	03213107	Duo	25	25	120	36	32,2	25,0	200,0	95,0	-6,0	-6,0	0,8	CN..1204..
DCLNR3232X12JETI	03282315	Duo	32	32	140	41	40,0	32,0	200,0	95,0	-6,0	-6,0	1,2	CN..1204..
DCLNL2020X12JETI	03213104	Duo	20	20	100	36	27,2	20,0	200,0	95,0	-6,0	-6,0	0,4	CN..1204..
DCLNL2525X12JETI	03213105	Duo	25	25	120	36	32,2	25,0	200,0	95,0	-6,0	-6,0	0,7	CN..1204..
DCLNL3232X12JETI	03282313	Duo	32	32	140	41	40,0	32,0	200,0	95,0	-6,0	-6,0	1,2	CN..1204..
DCLNR3232X16JETI	03282316	Duo	32	32	139	40	40,0	32,0	200,0	95,0	-6,0	-6,0	1,1	CN..1606..
DCLNL3232X16JETI	03282314	Duo	32	32	139	40	40,0	32,0	200,0	95,0	-6,0	-6,0	1,1	CN..1606..

Spare Parts

For size	Clamp screw	Coolant kit	Insert shim	Plug	Plug screw	Shim/clamp key	Shim screw	Spring
20/25	L85021-T15P	CN17L00R-2-SET	DCO120310	JET-P1/8-5MM	P6SS3X3G	T15P-2	C04008-T15P	S7111
32...12	L85021-T15P	CN17L00R-2-SET	DCO120310	JET-P1/8-5MM	P6SS3X3G	T15P-2	C04008-T15P	S7111
32...16	L85021-T15P	CN21L00R-2-SET	DCN160616	JET-P1/8-5MM	P6SS3X3G	T15P-2	C05010-T20P	S7111

Accessories

For size	Duo coolant plug screw	Insert clamping torque	Plug screw JETI	Shim key	Torque key
20/25	P6SS3X5	3.5NM	P6SS6X6	-	T00-15P35
32...12	P6SS3X5	3.5NM	P6SS6X6	-	T00-15P35
32...16	P6SS3X5	3.5NM	P6SS6X6	T20P-2D	T00-15P35

DCLNR/L...JETI – Toolholders for inserts CNGA, CNGG, CNGM, CNMA, CNMG and CNMM – Inch

DCLNR/L...JETI
KAPR = 95,0°

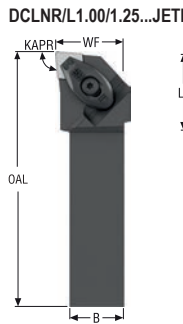
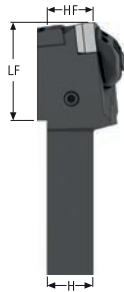
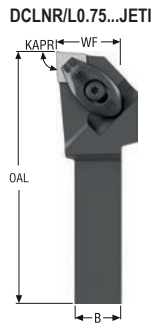
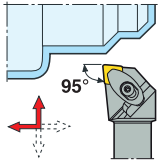

CTWS



- For inserts program, see page(s) 527, 528, 529, 530, 531, 532, 533, 575, 576, 597
- For more information on Jetstream Tooling® (High pressure coolant) and accessories, please see page(s) 38, 85-89, 1002
- GAMO° = Rake angle, LAMS° = Inclination angle
- CTWS = Insert shape and size
- For holder code key, see page(s) 17-18
- For suitable adapter, see page(s) 962-973
- * When using toolholder together with an adapter the maximum coolant pressure might be limited, please see page(s) 85
- ** Jetstream Tooling® Duo, see page(s) 38, 85-89
- For JETI coolant clamp it is recommended to set regular screw and double O-rings exchange rate to keep the safety first and minimize leakage for the application at hand
- Right-hand version shown
- Please check availability at www.secotools.com / Seco Online Store

Designation	Item number	**	H	B	OAL	LF	WF	HF	CP*	KAPR°	GAMO°	LAMS°	Weight	CTWS
			Inch	Inch	Inch	Inch	Inch	Inch	psi				lbs	
DCLNR-12-4XJETI	03282262	Duo	0.750	0.750	4.134	1.614	1.059	0.750	2900.8	95,0	-6,0	-6,0	0.880	CN.43.
DCLNR-16-4XJETI	03282263	Duo	1.000	1.000	4.724	1.417	1.260	1.000	2900.8	95,0	-6,0	-6,0	1.540	CN.43.
DCLNR-20-4XJETI	03282264	Duo	1.250	1.250	5.315	1.417	1.500	1.250	2900.8	95,0	-6,0	-6,0	1.540	CN.43.
DCLNL-12-4XJETI	03282259	Duo	0.750	0.750	4.134	1.614	1.059	0.750	2900.8	95,0	-6,0	-6,0	0.880	CN.43.
DCLNL-16-4XJETI	03282260	Duo	1.000	1.000	4.724	1.417	1.260	1.000	2900.8	95,0	-6,0	-6,0	1.540	CN.43.
DCLNL-20-4XJETI	03282261	Duo	1.250	1.250	5.315	1.417	1.500	1.250	2900.8	95,0	-6,0	-6,0	1.980	CN.43.

Spare Parts

For size	Clamp screw	Coolant kit	Insert shim	Plug	Plug screw	Shim/clamp key	Shim screw	Spring
..-12-4	L85021-T15P	CN17L00R-2-SET	DCO120310	JET-P1/8-5MM	P6SS3X3G	T15P-2	C04008-T15P	S7111
..-16-4	L85021-T15P	CN17L00R-2-SET	DCO120310	JET-P1/8-5MM	P6SS3X3G	T15P-2	C04008-T15P	S7111
..-20-4	L85021-T15P	CN17L00R-2-SET	DCO120310	JET-P1/8-5MM	P6SS3X3G	T15P-2	C04008-T15P	S7111

Accessories

For size	Duo coolant plug screw	Insert clamping torque	Plug screw JETI	Torque key
..-12-4	P6SS3X5	31.0IN.LBS	P6SS6X6	T00-15P35
..-16-4	P6SS3X5	31.0IN.LBS	P6SS6X6	T00-15P35
..-20-4	P6SS3X5	31.0IN.LBS	P6SS6X6	T00-15P35

General ISO Turning Holders
Steadyline®
MDT
Mini-Shaft™
Grooving
Parting-off
X4
Adapters Clamping units
Accessories and Spare parts
Workpiece materials

DDJCR/L...JETI – Toolholders for inserts DCGT, DCGW, DCMT, DCMW and DCMX – Metric



DDJCR/L2020...JETI

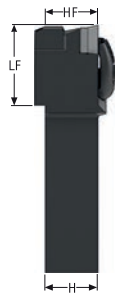
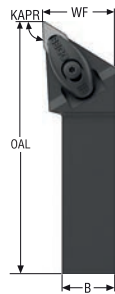

DDJCR/L2525...JETI

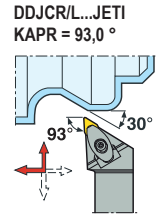
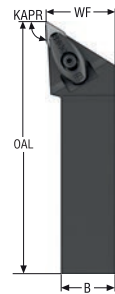

CTWS



- For inserts program, see page(s) 534, 535, 536, 578, 600
- For more information on Jetstream Tooling® (High pressure coolant) and accessories, please see page(s) 38, 85-89, 1002
- GAMO° = Rake angle, LAMS° = Inclination angle
- CTWS = Insert shape and size
- For holder code key, see page(s) 15-16
- For suitable adapter, see page(s) 962-973
- * When using toolholder together with an adapter the maximum coolant pressure might be limited, please see page(s) 85
- ** Jetstream Tooling® Duo, see page(s) 38, 85-89
- For JETI coolant clamp it is recommended to set regular screw and double O-rings exchange rate to keep the safety first and minimize leakage for the application at hand
- Right-hand version shown
- Please check availability at www.secotools.com / Seco Online Store

Designation	Item number	**	H	B	OAL	LF	WF	HF	CP*	KAPR°	GAMO°	LAMS°	Weight	CTWS
			mm	mm	mm	mm	mm	mm	bar				kg	
DDJCR2020X11JETI	03213110	Duo	20	20	95	31	27,2	20,0	200,0	93,0	0,0	0,0	0,4	DC..11T3..
DDJCR2525X11JETI	03213111	Duo	25	25	117	33	32,2	25,0	200,0	93,0	0,0	0,0	0,5	DC..11T3..
DDJCL2020X11JETI	03213108	Duo	20	20	95	31	27,2	20,0	200,0	93,0	0,0	0,0	0,4	DC..11T3..
DDJCL2525X11JETI	03213109	Duo	25	25	117	33	32,2	25,0	200,0	93,0	0,0	0,0	0,5	DC..11T3..

Spare Parts

For size	Clamp key	Clamp screw	Coolant kit	Insert shim	Plug	Plug screw	Shim screw	Spring
...11	T09P-2	L84017-T09P	CP14U00S-2-SET	126.19-620	JET-P1/8-5MM	P6SS3X3G	C94006-T15P	S5808

Accessories

For size	Duo coolant plug screw	Insert clamping torque	Plug screw JETI	Shim key	Torque key
...11	P6SS3X5	2.0NM	P6SS6X6	T15P-2	T00-09P20

General ISO Turning Holders
Steadyline®
MDT
Mini-Shaft™
Grooving
Parting-off
X4
Adapters Clamping units
Accessories and Spare parts
Workpiece materials

DDJCR/L...JETI – Toolholders for inserts DCGT, DCGW, DCMT, DCMW and DCMX – Inch

DDJCR/L...JETI
KAPR = 93,0°

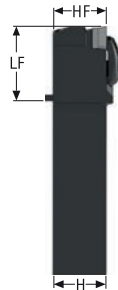
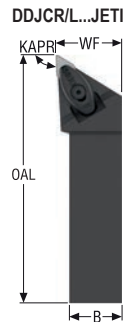
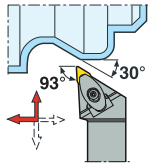

- For inserts program, see page(s) 534, 535, 536, 578, 600
- For more information on Jetstream Tooling® (High pressure coolant) and accessories, please see page(s) 38, 85-89, 1002
- GAMO° = Rake angle, LAMS° = Inclination angle
- CTWS = Insert shape and size
- For holder code key, see page(s) 17-18
- For suitable adapter, see page(s) 962-973
- * When using toolholder together with an adapter the maximum coolant pressure might be limited, please see page(s) 85
- ** Jetstream Tooling® Duo, see page(s) 38, 85-89
- For JETI coolant clamp it is recommended to set regular screw and double O-rings exchange rate to keep the safety first and minimize leakage for the application at hand
- Right-hand version shown
- Please check availability at www.secotools.com / Seco Online Store

Designation	Item number	**	H	B	OAL	LF	WF	HF	CP*	KAPR°	GAMO°	LAMS°	Weight	CTWS
			Inch	Inch	Inch	Inch	Inch	Inch	psi				lbs	
DDJCR-12-3XJETI	03282267	Duo	0.750	0.750	3.740	1.220	1.051	0.750	2900.8	93,0	0,0	0,0	1.100	DC..32.5.
DDJCR-16-3XJETI	03282268	Duo	1.000	1.000	4.724	1.417	1.260	1.000	2900.8	93,0	0,0	0,0	1.100	DC..32.5.
DDJCL-12-3XJETI	03282265	Duo	0.750	0.750	3.740	1.220	1.051	0.750	2900.8	93,0	0,0	0,0	1.100	DC..32.5.
DDJCL-16-3XJETI	03282266	Duo	1.000	1.000	4.724	1.417	1.260	1.000	2900.8	93,0	0,0	0,0	1.100	DC..32.5.

Spare Parts

For size	Clamp key	Clamp screw	Coolant kit	Insert shim	Plug	Plug screw	Shim screw	Spring
..-12-3	T09P-2	L84017-T09P	CP14U00S-2-SET	126.19-620	JET-P1/8-5MM	P6SS3X3G	C94006-T15P	S5808
..-16-3	T09P-2	L84017-T09P	CP14U00S-2-SET	126.19-620	JET-P1/8-5MM	P6SS3X3G	C94006-T15P	S5808

Accessories

For size	Duo coolant plug screw	Insert clamping torque	Plug screw JETI	Shim key	Torque key
..-12-3	P6SS3X5	17.7IN.LBS	P6SS6X6	T15P-2	T00-09P20
..-16-3	P6SS3X5	17.7IN.LBS	P6SS6X6	T15P-2	T00-09P20

General ISO Turning Holders
Steadyline®
MDT
Mini-Shaft™
Grooving
Parting-off
X4
Adapters Clamping units
Accessories and Spare parts
Workpiece materials

DDJNR/L...JETI – Toolholders for inserts DNGA, DNGM, DNMA, DNMM, DNMU and DNMX – Metric

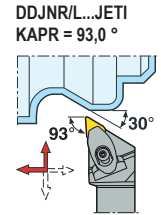
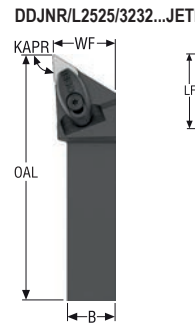
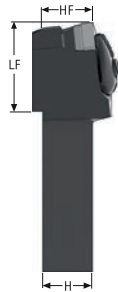
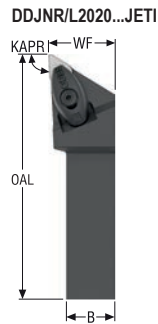





- For inserts program, see page(s) 537, 538, 539, 540, 541, 579, 580, 598
- For more information on Jetstream Tooling® (High pressure coolant) and accessories, please see page(s) 38, 85-89, 1002
- GAMO° = Rake angle, LAMS° = Inclination angle
- CTWS = Insert shape and size
- For holder code key, see page(s) 15-16
- For suitable adapter, see page(s) 962-973
- * When using toolholder together with an adapter the maximum coolant pressure might be limited, please see page(s) 85
- ** Jetstream Tooling® Duo, see page(s) 38, 85-89
- For JETI coolant clamp it is recommended to set regular screw and double O-rings exchange rate to keep the safety first and minimize leakage for the application at hand
- Right-hand version shown
- * Use the right shim & the right screw for the selected insert. For details, see page 99
- Please check availability at www.secotools.com / Seco Online Store

Designation	Item number	**	H	B	OAL	LF	WF	HF	CP*	KAPR°	GAMO°	LAMS°	Weight	CTWS
			mm	mm	mm	mm	mm	mm	bar				kg	
DDJNR2020X11JETI	03213114	Duo	20	20	100	36	27,2	20,0	200,0	93,0	-6,0	-6,0	0,3	DNMU1104..
DDJNR2525X11JETI	03213115	Duo	25	25	120	36	32,2	25,0	200,0	93,0	-6,0	-6,0	0,5	DNMU1104..
DDJNL2020X11JETI	03213112	Duo	20	20	100	36	27,2	20,0	200,0	93,0	-6,0	-6,0	0,4	DNMU1104..
DDJNL2525X11JETI	03213113	Duo	25	25	120	36	32,2	25,0	200,0	93,0	-6,0	-6,0	0,7	DNMU1104..
DDJNR2020X15JETI	03213118	Duo	20	20	105	41	27,2	20,0	200,0	93,0	-6,0	-6,0	0,4	DN.1504/DN..1506*
DDJNR2525X15JETI	03213119	Duo	25	25	127	43	32,2	25,0	200,0	93,0	-6,0	-6,0	0,6	DN.1504/DN..1506*
DDJNR3232X15JETI	03282318	Duo	32	32	145	46	40,0	32,0	200,0	93,0	-6,0	-6,0	1,1	DN.1504/DN..1506*
DDJNL2020X15JETI	03213116	Duo	20	20	105	41	27,2	20,0	200,0	93,0	-6,0	-6,0	0,4	DN.1504/DN..1506*
DDJNL2525X15JETI	03213117	Duo	25	25	127	43	32,2	25,0	200,0	93,0	-6,0	-6,0	0,5	DN.1504/DN..1506*
DDJNL3232X15JETI	03282317	Duo	32	32	145	46	40,0	32,0	200,0	93,0	-6,0	-6,0	1,1	DN.1504/DN..1506*

Spare Parts

For size	Clamp screw	Coolant kit	Insert shim	Plug	Plug screw	Shim/clamp key	Shim screw	Spring
R-11	L84017-T09P	CX14U10S-2R-SET	DDN110310	JET-P1/8-5MM	P6SS3X3G	T09P-2	C03007-T09P	S5808
L-11	L84017-T09P	CX14U10S-2L-SET	DDN110310	JET-P1/8-5MM	P6SS3X3G	T09P-2	C03007-T09P	S5808
R-15	L85021-T15P	CN17U10S-2R-SET	DDN150416	JET-P1/8-5MM	P6SS3X3G	T15P-2	C04008-T15P	S7111
L-15	L85021-T15P	CN17U10S-2L-SET	DDN150416	JET-P1/8-5MM	P6SS3X3G	T15P-2	C04008-T15P	S7111

Accessories

For size	Duo coolant plug screw	Insert clamping torque	Plug screw JETI	Torque key
				
R-11	P6SS3X5	2.0NM	P6SS6X6	T00-09P20
L-11	P6SS3X5	2.0NM	P6SS6X6	T00-09P20
R-15	P6SS3X5	3.5NM	P6SS6X6	T00-15P35
L-15	P6SS3X5	3.5NM	P6SS6X6	T00-15P35

General ISO Turning
Holders

Steadyline®

MDT

Mini-Shaft™

Grooving

Parting-off

X4

Adapters
Clamping units

Accessories and
Spare parts

Workpiece
materials

DDJNR/L...JETI – Toolholders for inserts DNGA, DNGM, DNMA, DNMM, DNMU and DNMX – Inch



DDJNR/L0.75...JETI

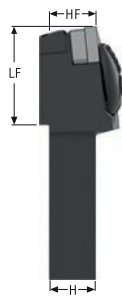
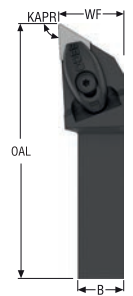

DDJNR/L1.00/1.25...JETI

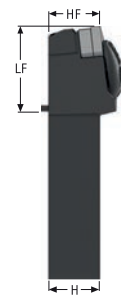
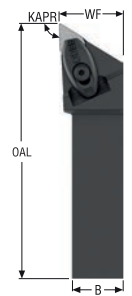

DDJNR/L...JETI
KAPR = 93,0°

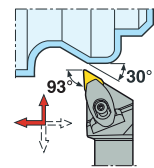

CTWS



- For inserts program, see page(s) 537, 538, 539, 540, 541, 579, 580, 598
- For more information on Jetstream Tooling® (High pressure coolant) and accessories, please see page(s) 38, 85-89, 1002
- GAMO° = Rake angle, LAMS° = Inclination angle
- CTWS = Insert shape and size
- For holder code key, see page(s) 17-18
- For suitable adapter, see page(s) 962-973
- * When using toolholder together with an adapter the maximum coolant pressure might be limited, please see page(s) 85
- ** Jetstream Tooling® Duo, see page(s) 38, 85-89
- For JETI coolant clamp it is recommended to set regular screw and double O-rings exchange rate to keep the safety first and minimize leakage for the application at hand
- Right-hand version shown
- * Use the right shim & the right screw for the selected insert. For details, see page 99
- Please check availability at www.secotools.com / Seco Online Store

Designation	Item number	**	H	B	OAL	LF	WF	HF	CP*	KAPR°	GAMO°	LAMS°	Weight	CTWS
			Inch	Inch	Inch	Inch	Inch	Inch	psi				lbs	
DDJNR-12-4XJETI	03282272	Duo	0.750	0.750	4.134	1.614	1.059	0.750	2900.8	93,0	-6,0	-6,0	0.880	DN..43/DN..44*
DDJNR-16-4XJETI	03282273	Duo	1.000	1.000	5.000	1.693	1.260	1.000	2900.8	93,0	-6,0	-6,0	1.540	DN..43/DN..44*
DDJNR-20-4XJETI	03282274	Duo	1.250	1.250	5.709	1.811	1.500	1.250	2900.8	93,0	-6,0	-6,0	1.980	DN..43/DN..44*
DDJNL-12-4XJETI	03282269	Duo	0.750	0.750	4.134	1.614	1.059	0.750	2900.8	93,0	-6,0	-6,0	0.880	DN..43/DN..44*
DDJNL-16-4XJETI	03282270	Duo	1.000	1.000	5.000	1.693	1.260	1.000	2900.8	93,0	-6,0	-6,0	1.540	DN..43/DN..44*
DDJNL-20-4XJETI	03282271	Duo	1.250	1.250	5.709	1.811	1.500	1.250	2900.8	93,0	-6,0	-6,0	2.650	DN..43/DN..44*

Spare Parts

For size	Clamp screw	Coolant kit	Insert shim	Plug	Plug screw	Shim/clamp key	Shim screw	Spring
..R-12/16-4	L85021-T15P	CN17U10S-2R-SET	DDN444	JET-P1/8-5MM	P6SS3X3G	T15P-2	C04011-T15P	S7111
...-20-4	L85021-T15P	CN17U10S-2L-SET	DDN444	JET-P1/8-5MM	P6SS3X3G	T15P-2	C04011-T15P	S7111
..L-12/16-4	L85021-T15P	CN17U10S-2L-SET	DDN444	JET-P1/8-5MM	P6SS3X3G	T15P-2	C04011-T15P	S7111

Accessories

For size	Duo coolant plug screw	Insert clamping torque	Plug screw JETI	Torque key
..R-12/16-4	P6SS3X5	31.0IN.LBS	P6SS6X6	T00-15P35
...-20-4	P6SS3X5	31.0IN.LBS	P6SS6X6	T00-15P35
..L-12/16-4	P6SS3X5	31.0IN.LBS	P6SS6X6	T00-15P35

DSSNR/L...JETI – Toolholders for inserts SNGA, SNMA, SNMG and SNMM – Metric

DSSNR/L...JETI
KAPR = 45,0°

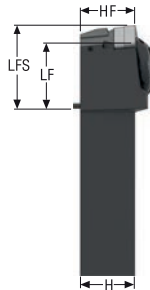
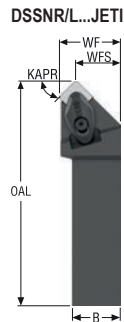
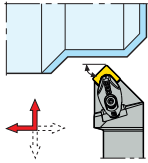

CTWS



- For inserts program, see page(s) 550, 551, 552, 553, 585
- For more information on Jetstream Tooling® (High pressure coolant) and accessories, please see page(s) 38, 85-89, 1002
- GAMO° = Rake angle, LAMS° = Inclination angle
- CTWS = Insert shape and size
- For holder code key, see page(s) 15-16
- For suitable adapter, see page(s) 962-973
- * When using toolholder together with an adapter the maximum coolant pressure might be limited, please see page(s) 85
- ** Jetstream Tooling® Duo, see page(s) 38, 85-89
- For JETI coolant clamp it is recommended to set regular screw and double O-rings exchange rate to keep the safety first and minimize leakage for the application at hand
- Right-hand version shown
- Please check availability at www.secotools.com / Seco Online Store

Designation	Item number	**	H	B	OAL	LF	WF	HF	CP*	KAPR°	GAMO°	LAMS°	Weight	CTWS
			mm	mm	mm	mm	mm	mm	bar				kg	
DSSNR2525X12JETI	03282326	Duo	25	25	128	36	32,0	25,0	200,0	45,0	-8,0	0,0	0,7	SN..1204..
DSSNL2525X12JETI	03282323	Duo	25	25	128	36	32,0	25,0	200,0	45,0	-8,0	0,0	0,6	SN..1204..
DSSNR3232X15JETI	03282327	Duo	32	32	149	40	40,0	32,0	200,0	45,0	-8,0	0,0	1,2	SN..1506..
DSSNL3232X15JETI	03282325	Duo	32	32	149	40	40,0	32,0	200,0	45,0	-8,0	0,0	1,2	SN..1506..

Spare Parts

For size	Clamp key	Clamp screw	Coolant kit	Insert shim	Plug	Plug screw	Shim/clamp key	Shim screw	Spring
R-12	-	L85021-T15P	CN17L00R-2-SET	DSN120616	JET-P1/8-5MM	P6SS3X3G	T15P-2	C04008-T15P	S7111
L-12	-	L85021-T15P	CN17L00R-2-SET	DSN120616	JET-P1/8-5MM	P6SS3X3G	T15P-2	C04008-T15P	S7111
R-15	T15P-2	L85021-T15P	CN21L00R-2-SET	DSN150624	JET-P1/8-5MM	P6SS3X3G	-	C05010-T20P	S7111
L-15	T15P-2	L85021-T15P	CN21L00R-2-SET	DSN150624	JET-P1/8-5MM	P6SS3X3G	-	C05010-T20P	S7111

Accessories

For size	Duo coolant plug screw	Insert clamping torque	Plug screw JETI	Shim key	Torque key
R-12	P6SS3X5	3.5NM	P6SS6X6	-	T00-15P35
L-12	P6SS3X5	3.5NM	P6SS6X6	-	T00-15P35
R-15	P6SS3X5	3.5NM	P6SS6X6	T20P-2D	T00-15P35
L-15	P6SS3X5	3.5NM	P6SS6X6	T20P-2D	T00-15P35

General ISO Turning Holders
Steadyline®
MDT
Mini-Shaft™
Grooving
Parting-off
X4
Adapters Clamping units
Accessories and Spare parts
Workpiece materials

DSSNR/L...JETI – Toolholders for inserts SNGA, SNMA, SNMG and SNMM – Inch

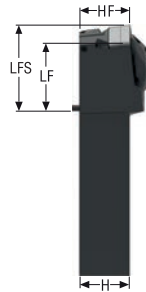
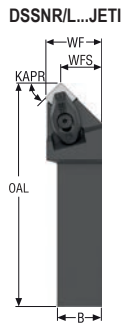

DSSNR/L...JETI
KAPR = 45,0 °

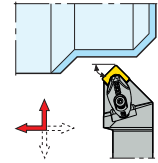

CTWS



- For inserts program, see page(s) 550, 551, 552, 553, 585
- For more information on Jetstream Tooling® (High pressure coolant) and accessories, please see page(s) 38, 85-89, 1002
- GAMO° = Rake angle, LAMS° = Inclination angle
- CTWS = Insert shape and size
- For holder code key, see page(s) 17-18
- For suitable adapter, see page(s) 962-973
- * When using toolholder together with an adapter the maximum coolant pressure might be limited, please see page(s) 85
- ** Jetstream Tooling® Duo, see page(s) 38, 85-89
- For JETI coolant clamp it is recommended to set regular screw and double O-rings exchange rate to keep the safety first and minimize leakage for the application at hand
- Right-hand version shown
- Please check availability at www.secotools.com / Seco Online Store

Designation	Item number	**	H	B	OAL	LF	WF	HF	CP*	KAPR°	GAMO°	LAMS°	Weight	CTWS
			Inch	Inch	Inch	Inch	Inch	Inch	psi				lbs	
DSSNR-16-4XJETI	03282282	Duo	1.000	1.000	5.035	1.417	1.260	1.000	2900.8	45,0	-8,0	0,0	1.320	SN..43.
DSSNL-16-4XJETI	03282281	Duo	1.000	1.000	5.035	1.417	1.260	1.000	2900.8	45,0	-8,0	0,0	2.200	SN..43.

Spare Parts

For size	Clamp screw	Coolant kit	Insert shim	Plug	Plug screw	Shim/clamp key	Shim screw	Spring
...-16-4	L85021-T15P	CN17L00R-2-SET	DSN444	JET-P1/8-5MM	P6SS3X3G	T15P-2	C04008-T15P	S7111

Accessories

For size	Duo coolant plug screw	Insert clamping torque	Plug screw JETI	Torque key
...-16-4	P6SS3X5	31.0IN.LBS	P6SS6X6	T00-15P35

General ISO Turning Holders
Steadyline®
MDT
Mini-Shaft™
Grooving
Parting-off
X4
Adapters Clamping units
Accessories and Spare parts
Workpiece materials

DTJNR/L...JETI – Toolholders for inserts TNGA, TNMA, TNMG, TNMM and TNMX – Metric

DTJNR/L...JETI
KAPR = 93,0°

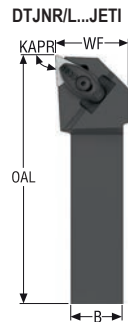
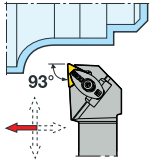

CTWS



- For inserts program, see page(s) 558, 559, 560, 561, 590, 593
- For more information on Jetstream Tooling® (High pressure coolant) and accessories, please see page(s) 38, 85-89, 1002
- GAMO° = Rake angle, LAMS° = Inclination angle
- CTWS = Insert shape and size
- For holder code key, see page(s) 15-16
- For suitable adapter, see page(s) 962-973
- * When using toolholder together with an adapter the maximum coolant pressure might be limited, please see page(s) 85
- ** Jetstream Tooling® Duo, see page(s) 38, 85-89
- For JETI coolant clamp it is recommended to set regular screw and double O-rings exchange rate to keep the safety first and minimize leakage for the application at hand
- Right-hand version shown
- Please check availability at www.secotools.com / Seco Online Store

Designation	Item number	**	H	B	OAL	LF	WF	HF	CP*	KAPR°	GAMO°	LAMS°	Weight	CTWS
			mm	mm	mm	mm	mm	mm	bar				kg	
DTJNR2020X16JETI	03282330	Duo	20	20	95	31	27,0	20,0	200,0	93,0	-6,0	-6,0	0,4	TN..1604..
DTJNR2525X16JETI	03282331	Duo	25	25	120	36	32,0	25,0	200,0	93,0	-6,0	-6,0	0,6	TN..1604..
DTJNL2020X16JETI	03282328	Duo	20	20	95	31	27,0	20,0	200,0	93,0	-6,0	-6,0	0,4	TN..1604..
DTJNL2525X16JETI	03282329	Duo	25	25	120	36	32,0	25,0	200,0	93,0	-6,0	-6,0	0,6	TN..1604..

Spare Parts

For size	Clamp screw	Coolant kit	Insert shim	Plug	Plug screw	Shim/clamp key	Shim screw	Spring
R-16	L84017-T09P	CN14U10S-2L-SET	DTN160616	JET-P1/8-5MM	P6SS3X3G	T09P-2	C03007-T09P	S5808
L-16	L84017-T09P	CN14U10S-2R-SET	DTN160616	JET-P1/8-5MM	P6SS3X3G	T09P-2	C03007-T09P	S5808

Accessories

For size	Insert clamping torque	Plug screw	Plug screw JETI	Torque key
R-16	2.0NM	P6SS3X5	P6SS6X6	T00-09P20
L-16	2.0NM	P6SS3X5	P6SS6X6	T00-09P20

DTJNR/L...JETI – Toolholders for inserts TNGA, TNMA, TNMG, TNMM and TNMX – Inch

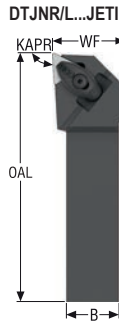

DTJNR/L...JETI
KAPR = 93,0 °

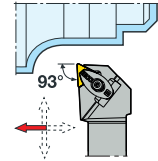

CTWS



- For inserts program, see page(s) 558, 559, 560, 561, 590, 593
- For more information on Jetstream Tooling® (High pressure coolant) and accessories, please see page(s) 38, 85-89, 1002
- GAMO° = Rake angle, LAMS° = Inclination angle
- CTWS = Insert shape and size
- For holder code key, see page(s) 17-18
- For suitable adapter, see page(s) 962-973
- * When using toolholder together with an adapter the maximum coolant pressure might be limited, please see page(s) 85
- ** Jetstream Tooling® Duo, see page(s) 38, 85-89
- For JETI coolant clamp it is recommended to set regular screw and double O-rings exchange rate to keep the safety first and minimize leakage for the application at hand
- Right-hand version shown
- Please check availability at www.secotools.com / Seco Online Store

Designation	Item number	**	H	B	OAL	LF	WF	HF	CP*	KAPR°	GAMO°	LAMS°	Weight	CTWS
			Inch	Inch	Inch	Inch	Inch	Inch	psi				lbs	
DTJNR-16-3XJETI	03282284	Duo	1.000	1.000	4.724	1.417	1.260	1.000	2900.8	93,0	-6,0	-6,0	1.320	TN..33.
DTJNL-16-3XJETI	03282283	Duo	1.000	1.000	4.724	1.417	1.260	1.000	2900.8	93,0	-6,0	-6,0	1.980	TN..33.

Spare Parts

For size	Clamp screw	Coolant kit	Insert shim	Plug	Plug screw	Shim/clamp key	Shim screw	Spring
..R-16-3	L84017-T09P	CN14U10S-2L-SET	DTN344	JET-P1/8-5MM	P6SS3X3G	T09P-2	C03007-T09P	S5808
..L-16-3	L84017-T09P	CN14U10S-2R-SET	DTN344	JET-P1/8-5MM	P6SS3X3G	T09P-2	C03007-T09P	S5808

Accessories

For size	Duo coolant plug screw	Insert clamping torque	Plug screw JETI	Torque key
..R-16-3	P6SS3X5	17.7IN.LBS	P6SS6X6	T00-09P20
..L-16-3	P6SS3X5	17.7IN.LBS	P6SS6X6	T00-09P20

General ISO Turning Holders
Steadyline®
MDT
Mini-Shaft™
Grooving
Parting-off
X4
Adapters Clamping units
Accessories and Spare parts
Workpiece materials

DVJBR/L...JETI – Toolholders for inserts VBGT, VBGW, VBMT, VBMT and VCGT – Metric

DVJBR/L...JETI
KAPR = 93,0°

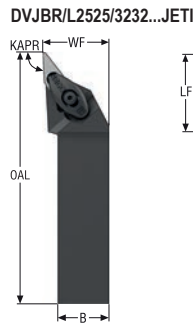
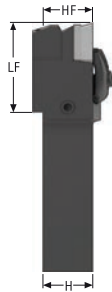
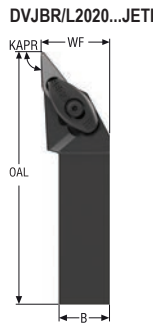
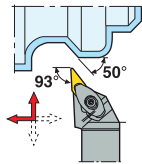

- For inserts program, see page(s) 563, 564, 564, 594, 602
- For more information on Jetstream Tooling® (High pressure coolant) and accessories, please see page(s) 38, 85-89, 1002
- GAMO° = Rake angle, LAMS° = Inclination angle
- CTWS = Insert shape and size
- For holder code key, see page(s) 15-16
- For suitable adapter, see page(s) 962-973
- * When using toolholder together with an adapter the maximum coolant pressure might be limited, please see page(s) 85
- ** Jetstream Tooling® Duo, see page(s) 38, 85-89
- For JETI coolant clamp it is recommended to set regular screw and double O-rings exchange rate to keep the safety first and minimize leakage for the application at hand
- Right-hand version shown
- Please check availability at www.secotools.com / Seco Online Store

Designation	Item number	**	H	B	OAL	LF	WF	HF	CP*	KAPR°	GAMO°	LAMS°	Weight	CTWS
			mm	mm	mm	mm	mm	mm	bar				kg	
DVJBR2020X16JETI	03213122	Duo	20	20	100	36	27,2	20,0	200,0	93,0	0,0	0,0	0,5	VB../VC../1604..
DVJBR2525X16JETI	03213123	Duo	25	25	122	38	32,2	25,0	200,0	93,0	0,0	0,0	0,5	VB../VC../1604..
DVJBR3232X16JETI	03282333	Duo	32	32	139	40	40,0	32,0	200,0	93,0	0,0	0,0	1,0	VB../VC../1604..
DVJBL2020X16JETI	03213120	Duo	20	20	100	36	27,2	20,0	200,0	93,0	0,0	0,0	0,4	VB../VC../1604..
DVJBL2525X16JETI	03213121	Duo	25	25	122	38	32,2	25,0	200,0	93,0	0,0	0,0	0,6	VB../VC../1604..
DVJBL3232X16JETI	03282332	Duo	32	32	139	40	40,0	32,0	200,0	93,0	0,0	0,0	1,0	VB../VC../1604..

Spare Parts

For size	Clamp key	Clamp screw	Coolant kit	Insert shim	Plug	Plug screw	Shim screw	Spring
DVJBR	T09P-2	L84017-T09P	CP14U20S-2L-SET	171.19-620	JET-P1/8-5MM	P6SS3X3G	C94006-T15P	S5808
DVJBL	T09P-2	L84017-T09P	CP14U20S-2R-SET	171.19-620	JET-P1/8-5MM	P6SS3X3G	C94006-T15P	S5808

Accessories

For size	Duo coolant plug screw	Insert clamping torque	Plug screw JETI	Shim key	Torque key
DVJBR	P6SS3X5	2.0NM	P6SS6X6	T15P-2	T00-09P20
DVJBL	P6SS3X5	2.0NM	P6SS6X6	T15P-2	T00-09P20

General ISO Turning Holders
Steadyline®
MDT
Mini-Shaft™
Grooving
Parting-off
X4
Adapters Clamping units
Accessories and Spare parts
Workpiece materials

DVJBR/L...JETI – Toolholders for inserts VBGT, VBGW, VBMT, VBMT and VCGT – Inch

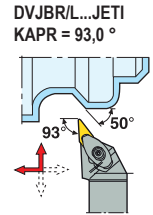
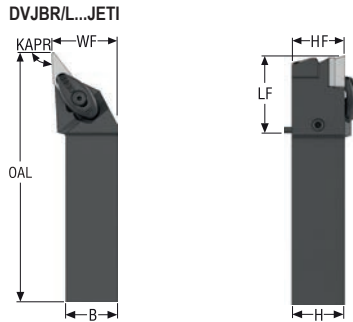

CTWS



- For inserts program, see page(s) 563, 564, 564, 594, 602
- For more information on Jetstream Tooling® (High pressure coolant) and accessories, please see page(s) 38, 85-89, 1002
- GAMO° = Rake angle, LAMS° = Inclination angle
- CTWS = Insert shape and size
- For holder code key, see page(s) 17-18
- For suitable adapter, see page(s) 962-973
- * When using toolholder together with an adapter the maximum coolant pressure might be limited, please see page(s) 85
- ** Jetstream Tooling® Duo, see page(s) 38, 85-89
- For JETI coolant clamp it is recommended to set regular screw and double O-rings exchange rate to keep the safety first and minimize leakage for the application at hand
- Right-hand version shown
- Please check availability at www.secotools.com / Seco Online Store

Designation	Item number	**	H	B	OAL	LF	WF	HF	CP*	KAPR°	GAMO°	LAMS°	Weight	CTWS
			Inch	Inch	Inch	Inch	Inch	Inch	psi				lbs	
DVJBR-12-3XJETI	03282287	Duo	0.750	0.750	3.937	1.417	1.059	0.750	2900.8	93,0	0,0	0,0	1.100	VB..33.
DVJBR-16-3XJETI	03282288	Duo	1.000	1.000	4.803	1.496	1.260	1.000	2900.8	93,0	0,0	0,0	1.320	VB..33.
DVJBL-12-3XJETI	03282285	Duo	0.750	0.750	3.937	1.417	1.059	0.750	2900.8	93,0	0,0	0,0	1.100	VB..33.
DVJBL-16-3XJETI	03282286	Duo	1.000	1.000	4.803	1.496	1.260	1.000	2900.8	93,0	0,0	0,0	1.320	VB..33.

Spare Parts

For size	Clamp key	Clamp screw	Coolant kit	Insert shim	Plug	Plug screw	Shim screw	Spring
..R-12-3								
..R-16-3	T09P-2	L84017-T09P	CP14U20S-2L-SET	171.19-620	JET-P1/8-5MM	P6SS3X3G	C94006-T15P	S5808
..L-12-3	T09P-2	L84017-T09P	CP14U20S-2R-SET	171.19-620	JET-P1/8-5MM	P6SS3X3G	C94006-T15P	S5808
..L-16-3	T09P-2	L84017-T09P	CP14U20S-2R-SET	171.19-620	JET-P1/8-5MM	P6SS3X3G	C94006-T15P	S5808

Accessories

For size	Duo coolant plug screw	Insert clamping torque	Plug screw JETI	Shim key	Torque key
..R-12-3					
..R-16-3	P6SS3X5	17.7IN.LBS	P6SS6X6	T15P-2	T00-09P20
..L-12-3	P6SS3X5	17.7IN.LBS	P6SS6X6	T15P-2	T00-09P20
..L-16-3	P6SS3X5	17.7IN.LBS	P6SS6X6	T15P-2	T00-09P20

DVJNR/L...JETI – Toolholders for inserts VNGA, VNGG, VNGM, VNMA and VNMG – Metric

DVJNR/L...JETI
KAPR = 93,0°

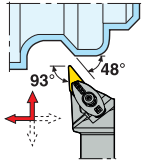

DSSNR/L2020...JETI

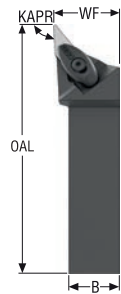

CTWS



- For inserts program, see page(s) 565, 566, 595
- For more information on Jetstream Tooling® (High pressure coolant) and accessories, please see page(s) 38, 85-89, 1002
- GAMO° = Rake angle, LAMS° = Inclination angle
- CTWS = Insert shape and size
- For holder code key, see page(s) 15-16
- For suitable adapter, see page(s) 962-973
- * When using toolholder together with an adapter the maximum coolant pressure might be limited, please see page(s) 85
- ** Jetstream Tooling® Duo, see page(s) 38, 85-89
- For JETI coolant clamp it is recommended to set regular screw and double O-rings exchange rate to keep the safety first and minimize leakage for the application at hand
- Right-hand version shown
- Please check availability at www.secotools.com / Seco Online Store

Designation	Item number	**	H	B	OAL	LF	WF	HF	CP*	KAPR°	GAMO°	LAMS°	Weight	CTWS
			mm	mm	mm	mm	mm	mm	bar				kg	
DVJNR2020X16JETI	03282337	Duo	20	20	100	36	27,2	20,0	200,0	93,0	-4,5	-13,5	0,3	VN..1604..
DVJNR2525X16JETI	03282338	Duo	25	25	122	36	32,2	25,0	200,0	93,0	-4,5	-13,5	0,6	VN..1604..
DVJNL2020X16JETI	03282334	Duo	20	20	100	36	27,2	20,0	200,0	93,0	-4,5	-13,5	0,3	VN..1604..
DVJNL2525X16JETI	03282336	Duo	25	25	122	36	32,2	25,0	200,0	93,0	-4,5	-13,5	0,6	VN..1604..

Spare Parts

For size	Clamp key	Clamp screw	Coolant kit	Insert shim	Plug	Plug screw	Shim screw	Spring
R-16	T09P-2	L84017-T09P	CN14U20S-2L-SET	171.19-620	JET-P1/8-5MM	P6SS3X3G	C94006-T15P	S5808
L-16	T09P-2	L84017-T09P	CN14U20S-2R-SET	171.19-620	JET-P1/8-5MM	P6SS3X3G	C94006-T15P	S5808

Accessories

For size	Duo coolant plug screw	Insert clamping torque	Plug screw JETI	Shim key	Torque key
R-16	P6SS3X5	2.0NM	P6SS6X6	T15P-2	T00-09P20
L-16	P6SS3X5	2.0NM	P6SS6X6	T15P-2	T00-09P20

DVJNR/L...JETI – Toolholders for inserts VNGA, VNGG, VNGM, VNMA and VNMG – Inch

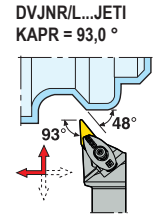
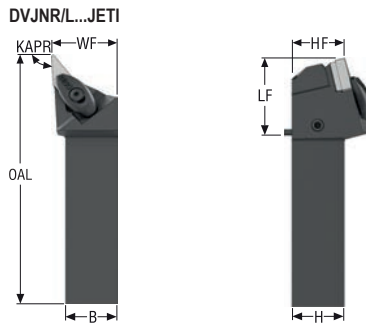

CTWS



- For inserts program, see page(s) 565, 566, 595
- For more information on Jetstream Tooling® (High pressure coolant) and accessories, please see page(s) 38, 85-89, 1002
- GAMO° = Rake angle, LAMS° = Inclination angle
- CTWS = Insert shape and size
- For holder code key, see page(s) 17-18
- For suitable adapter, see page(s) 962-973
- * When using toolholder together with an adapter the maximum coolant pressure might be limited, please see page(s) 85
- ** Jetstream Tooling® Duo, see page(s) 38, 85-89
- For JETI coolant clamp it is recommended to set regular screw and double O-rings exchange rate to keep the safety first and minimize leakage for the application at hand
- Right-hand version shown
- Please check availability at www.secotools.com / Seco Online Store

Designation	Item number	**	H	B	OAL	LF	WF	HF	CP*	KAPR°	GAMO°	LAMS°	Weight	CTWS
			Inch	Inch	Inch	Inch	Inch	Inch	psi				lbs	
DVJNR-12-3XJETI	03282292	Duo	0.750	0.750	4.055	1.535	1.059	0.750	2900.8	93,0	-4,5	-13,5	1.100	VN..33.
DVJNR-16-3XJETI	03282293	Duo	1.000	1.000	4.803	1.496	1.260	1.000	2900.8	93,0	-4,5	-13,5	1.320	VN..33.
DVJNR-20-3XJETI	03282294	Duo	1.250	1.250	5.472	1.575	1.500	1.250	2900.8	93,0	-4,5	-13,5	1.320	VN..33.
DVJNL-12-3XJETI	03282289	Duo	0.750	0.750	4.055	1.535	1.059	0.750	2900.8	93,0	-4,5	-13,5	1.980	VN..33.
DVJNL-16-3XJETI	03282290	Duo	1.000	1.000	4.803	1.496	1.260	1.000	2900.8	93,0	-4,5	-13,5	1.100	VN..33.
DVJNL-20-3XJETI	03282291	Duo	1.250	1.250	5.472	1.575	1.500	1.250	2900.8	93,0	-4,5	-13,5	2.650	VN..33.

Spare Parts

For size	Clamp key	Clamp screw	Coolant kit	Insert shim	Plug	Plug screw	Shim screw	Spring
...R	T09P-2	L84017-T09P	CN14U20S-2L-SET	171.19-620	JET-P1/8-5MM	P6SS3X3G	C94006-T15P	S5808
...L-12	T09P-2	L84017-T09P	CN14U10S-2R-SET	171.19-620	JET-P1/8-5MM	P6SS3X3G	C94006-T15P	S5808
...L-16/ 20	T09P-2	L84017-T09P	CN14U20S-2R-SET	171.19-620	JET-P1/8-5MM	P6SS3X3G	C94006-T15P	S5808

Accessories

For size	Duo coolant plug screw	Insert clamping torque	Plug screw JETI	Shim key	Torque key
...R	P6SS3X5	17.7IN.LBS	P6SS6X6	T15P-2	T00-09P20
...L-12	P6SS3X5	17.7IN.LBS	P6SS6X6	T15P-2	T00-09P20
...L-16/ 20	P6SS3X5	17.7IN.LBS	P6SS6X6	T15P-2	T00-09P20

DWLNRL/L...JETI – Toolholders for inserts WNGA, WNGG, WNMA, WNMG and WNMM – Metric

DWLNRL/L...JETI
KAPR = 95,0°

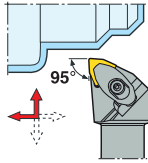

DWLNRL/L2020...JETI

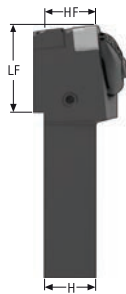

DWLNRL/L2525/3232...JETI

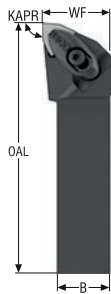

- For inserts program, see page(s) 568, 569, 570, 571, 596
- For more information on Jetstream Tooling® (High pressure coolant) and accessories, please see page(s) 38, 85-89, 1002
- GAMO° = Rake angle, LAMS° = Inclination angle
- CTWS = Insert shape and size
- For holder code key, see page(s) 15-16
- For suitable adapter, see page(s) 962-973
- * When using toolholder together with an adapter the maximum coolant pressure might be limited, please see page(s) 85
- ** Jetstream Tooling® Duo, see page(s) 38, 85-89
- For JETI coolant clamp it is recommended to set regular screw and double O-rings exchange rate to keep the safety first and minimize leakage for the application at hand
- Right-hand version shown
- * Use the right shim & the right screw for the selected insert. For details, see page 99
- Please check availability at www.secotools.com / Seco Online Store













Designation	Item number	**	H	B	OAL	LF	WF	HF	CP*	KAPR°	GAMO°	LAMS°	Weight	CTWS
			mm	mm	mm	mm	mm	mm	bar				kg	
DWLNRL2020X06JETI	03213128	Duo	20	20	95	31	27,2	20,0	200,0	95,0	-6,0	-6,0	0,3	WN..0604..
DWLNRL2525X06JETI	03213130	Duo	25	25	117	33	32,2	25,0	200,0	95,0	-6,0	-6,0	0,5	WN..0604..
DWLNRL2020X08JETI	03213124	Duo	20	20	95	31	27,2	20,0	200,0	95,0	-6,0	-6,0	0,4	WN..0604..
DWLNRL2525X08JETI	03213126	Duo	25	25	117	33	32,2	25,0	200,0	95,0	-6,0	-6,0	0,7	WN..0604..
DWLNRL2020X08JETI	03213129	Duo	20	20	100	36	27,2	20,0	200,0	95,0	-6,0	-6,0	0,4	WN..0804/WN..0806*
DWLNRL2525X08JETI	03213131	Duo	25	25	120	36	32,2	25,0	200,0	95,0	-6,0	-6,0	0,5	WN..0804/WN..0806*
DWLNRL3232X08JETI	03282340	Duo	32	32	139	40	40,0	32,0	200,0	95,0	-6,0	-6,0	1,1	WN..0804/WN..0806*
DWLNRL2020X08JETI	03213125	Duo	20	20	100	36	27,2	20,0	200,0	95,0	-6,0	-6,0	0,4	WN..0804/WN..0806*
DWLNRL2525X08JETI	03213127	Duo	25	25	120	36	32,2	25,0	200,0	95,0	-6,0	-6,0	0,7	WN..0804/WN..0806*
DWLNRL3232X08JETI	03282339	Duo	32	32	139	40	40,0	32,0	200,0	95,0	-6,0	-6,0	1,1	WN..0804/WN..0806*

Spare Parts

For size	Clamp screw	Coolant kit	Insert shim	Plug	Plug screw	Shim/clamp key	Shim screw	Spring
...06	L84017-T09P	CN14L00R-2-SET	DWN060310	JET-P1/8-5MM	P6SS3X3G	T09P-2	C03007-T09P	S5808
...08	L85021-T15P	CN17L00R-2-SET	DWN080416	JET-P1/8-5MM	P6SS3X3G	T15P-2	C04008-T15P	S7111
32...08	L85021-T15P	CN17L00R-2-SET	DWN080416	JET-P1/8-5MM	P6SS3X3G	T15P-2	C04008-T15P	S7111

General ISO Turning Holders
Steadyline®
MDT
Mini-Shaft™
Grooving
Parting-off
X4
Adapters Clamping units
Accessories and Spare parts
Workpiece materials

Accessories

For size	Duo coolant plug screw	Insert clamping torque	Plug screw JETI	Torque key
...06	 P6SS3X5	 2.0NM	 P6SS6X6	 T00-09P20
...08	 P6SS3X5	 3.5NM	 P6SS6X6	 T00-15P35
32...08	 P6SS3X5	 3.5NM	 P6SS6X6	 T00-15P35

General ISO Turning
Holders

Steadyline®

MDT

Mini-Shaft™

Grooving

Parting-off

X4

Adapters
Clamping units

Accessories and
Spare parts

Workpiece
materials

DWLNRL/L...JETI – Toolholders for inserts WNGA, WNGG, WNMA, WNMG and WNMM – Inch

DWLNRL/L...JETI
KAPR = 95,0°

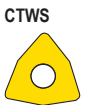
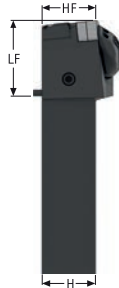
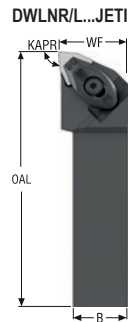
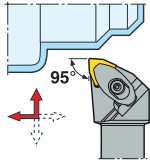

- For inserts program, see page(s) 568, 569, 570, 571, 596
- For more information on Jetstream Tooling® (High pressure coolant) and accessories, please see page(s) 38, 85-89, 1002
- GAMO° = Rake angle, LAMS° = Inclination angle
- CTWS = Insert shape and size
- For holder code key, see page(s) 17-18
- For suitable adapter, see page(s) 962-973
- * When using toolholder together with an adapter the maximum coolant pressure might be limited, please see page(s) 85
- ** Jetstream Tooling® Duo, see page(s) 38, 85-89
- For JETI coolant clamp it is recommended to set regular screw and double O-rings exchange rate to keep the safety first and minimize leakage for the application at hand
- Right-hand version shown
- * Use the right shim & the right screw for the selected insert. For details, see page 99
- Please check availability at www.secotools.com / Seco Online Store

Designation	Item number	**	H	B	OAL	LF	WF	HF	CP*	KAPR°	GAMO°	LAMS°	Weight	CTWS
			Inch	Inch	Inch	Inch	Inch	Inch	psi				lbs	
DWLNRL-12-3XJETI	03282300	Duo	0.750	0.750	3.740	1.220	1.059	0.750	2900.8	95,0	-6,0	-6,0	1.320	WN..33.
DWLNRL-16-3XJETI	03282302	Duo	1.000	1.000	4.606	1.299	1.260	1.000	2900.8	95,0	-6,0	-6,0	2.200	WN..33.
DWLNRL-12-4XJETI	03282295	Duo	0.750	0.750	3.740	1.220	1.059	0.750	2900.8	95,0	-6,0	-6,0	1.100	WN..33.
DWLNRL-16-4XJETI	03282297	Duo	1.000	1.000	4.606	1.299	1.260	1.000	2900.8	95,0	-6,0	-6,0	1.100	WN..33.
DWLNRL-12-4XJETI	03282301	Duo	0.750	0.750	4.055	1.535	1.059	0.750	2900.8	95,0	-6,0	-6,0	1.320	WN..43/WN..44*
DWLNRL-16-4XJETI	03282303	Duo	1.000	1.000	4.724	1.417	1.260	1.000	2900.8	95,0	-6,0	-6,0	1.540	WN..43/WN..44*
DWLNRL-20-4XJETI	03282304	Duo	1.250	1.250	5.472	1.575	1.500	1.250	2900.8	95,0	-6,0	-6,0	1.540	WN..43/WN..44*
DWLNRL-12-4XJETI	03282296	Duo	0.750	0.750	4.055	1.535	1.059	0.750	2900.8	95,0	-6,0	-6,0	1.320	WN..43/WN..44*
DWLNRL-16-4XJETI	03282298	Duo	1.000	1.000	4.724	1.417	1.260	1.000	2900.8	95,0	-6,0	-6,0	1.540	WN..43/WN..44*
DWLNRL-20-4XJETI	03282299	Duo	1.250	1.250	5.472	1.575	1.500	1.250	2900.8	95,0	-6,0	-6,0	1.320	WN..43/WN..44*

Spare Parts

For size	Clamp screw	Coolant kit	Insert shim	Plug	Plug screw	Shim/clamp key	Shim screw	Spring
...3	L84017-T09P	CN14L00R-2-SET	DWN322.5	JET-P1/8-5MM	P6SS3X3G	T09P-2	C03007-T09P	S5808
...4	L85021-T15P	CN17L00R-2-SET	DWN434	JET-P1/8-5MM	P6SS3X3G	T15P-2	C04008-T15P	S7111

Accessories

For size	Duo coolant plug screw	Insert clamping torque	Plug screw JETI	Torque key
...3	P6SS3X5	17.7IN.LBS	P6SS6X6	T00-09P20
...4	P6SS3X5	31.0IN.LBS	P6SS6X6	T00-15P35

General ISO Turning Holders
Steadyline®
MDT
Mini-Shaft™
Grooving
Parting-off
X4
Adapters Clamping units
Accessories and Spare parts
Workpiece materials

Toolholders for inserts RCMT – Metric

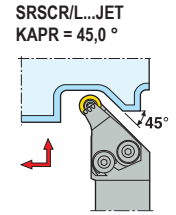
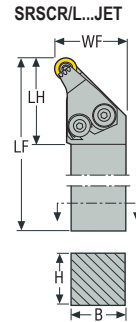

CTWS



- For inserts program, see page(s) 545, 546
- For more information on Jetstream Tooling® (High pressure coolant) and accessories, please see page(s) 38, 85-89, 1002
- GAMO° = Rake angle, LAMS° = Inclination angle
- CTWS = Insert shape and size
- For holder code key, see page(s) 15-16
- For JET1 coolant clamp it is recommended to set regular screw and double O-rings exchange rate to keep the safety first and minimize leakage for the application at hand
- Right-hand version shown
- Please check availability at www.secotools.com / Seco Online Store

Designation	Item number	**	H	B	LF	WF	CP*	KAPR°	GAMO°	LAMS°	Weight	CTWS
			mm	mm	mm	mm	bar				kg	
SRSCR2525M12JET	02605862	–	25	25	150	32,0	275,0	45,0	0,0	0,0	0,7	RCMT1204..
SRSCR3225P12JET	02605866	–	32	25	170	32,0	275,0	45,0	0,0	0,0	1,1	RCMT1204..
SRACL2525M12JET	02605863	–	25	25	150	32,0	275,0	45,0	0,0	0,0	0,7	RCMT1204..
SRACL3225P12JET	02605867	–	32	25	170	32,0	275,0	45,0	0,0	0,0	1,1	RCMT1204..

Spare Parts

For size	Inducer kit	Inducer screw	Insert/inducer key	Insert screw	Insert shim	O-ring	Plug	Shim screw
R-12	JET-CIKR00RA-KIT	117.26-655	3SMS795/T15P	C03510-T15P	111.19-621	ORING-6.07X1.78	JET-P1/8-5MM	CA3510
L-12	JET-CIKR00LA-KIT	117.26-655	3SMS795/T15P	C03510-T15P	111.19-621	ORING-6.07X1.78	JET-P1/8-5MM	CA3510

Accessories

For size	Insert clamping torque	Replacement blade	Shim key	Torque key
R-12	3.0NM	T00-15P	9/64SMS875	T00-15P30
L-12	3.0NM	T00-15P	9/64SMS875	T00-15P30

General ISO Turning Holders
Steadyline®
MDT
Mini-Shaft™
Grooving
Parting-off
X4
Adapters Clamping units
Accessories and Spare parts
Workpiece materials

SRSCR/L...JET – Toolholders for inserts RCMT – Inch

SRSCR/L...JET
KAPR = 45,0°

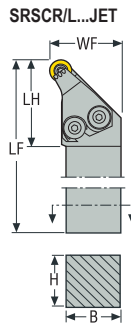
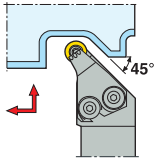

CTWS



- For inserts program, see page(s) 545, 546
- For more information on Jetstream Tooling® (High pressure coolant) and accessories, please see page(s) 38, 85-89, 1002
- GAMO° = Rake angle, LAMS° = Inclination angle
- CTWS = Insert shape and size
- For holder code key, see page(s) 17-18
- For JETI coolant clamp it is recommended to set regular screw and double O-rings exchange rate to keep the safety first and minimize leakage for the application at hand
- Right-hand version shown
- Please check availability at www.secotools.com / Seco Online Store

Designation	Item number	**	H	B	LF	WF	CP*	KAPR°	GAMO°	LAMS°	Weight	CTWS
			Inch	Inch	Inch	Inch	psi				lbs	
SRSCR-12-10JET	02610684	–	0.750	0.750	4.500	1.122	3988.5	45,0	0,0	0,0	1.100	RC..10T3..
SRSCR-12-12JET	02610686	–	0.750	0.750	4.500	1.161	3988.5	45,0	0,0	0,0	1.100	RCMM43
SRSCR-16-12JET	02610691	–	1.000	1.000	6.000	1.268	3988.5	45,0	0,0	0,0	1.760	RCMM43
SRSCR-20-12JET	02610695	–	1.250	1.250	6.000	1.500	3988.5	45,0	0,0	0,0	2.650	RCMM43
SRSCL-16-12JET	02610692	–	1.000	1.000	6.000	1.268	3988.5	45,0	0,0	0,0	1.760	RCMM43
SRSCL-20-12JET	02610696	–	1.250	1.250	6.000	1.500	3988.5	45,0	0,0	0,0	2.650	RCMM43

Spare Parts

For size	Inducer kit	Inducer screw	Insert/inducer key	Insert screw	Insert shim	O-ring	Plug	Shim screw
.R-12-10	JET-CIKR00RA-KIT	117.26-655	3SMS795/T15P	C03510-T15P	111.19-620	ORING-6.07X1.78	JET-P1/8-5MM	CA3510
.R-20/ 16/ 20-12	JET-CIKR00RA-KIT	117.26-655	3SMS795/T15P	C03510-T15P	111.19-621	ORING-6.07X1.78	JET-P1/8-5MM	CA3510
.L-16/ 20-12	JET-CIKR00LA-KIT	117.26-655	3SMS795/T15P	C03510-T15P	111.19-621	ORING-6.07X1.78	JET-P1/8-5MM	CA3510

Accessories

For size	Insert clamping torque	Replacement blade	Shim key	Torque key
.R-12-10	26.6IN.LBS	T00-15P	9/64SMS875	T00-15P30
.R-20/ 16/ 20-12	26.6IN.LBS	T00-15P	9/64SMS875	T00-15P30
.L-16/ 20-12	26.6IN.LBS	T00-15P	9/64SMS875	T00-15P30

General ISO Turning Holders
Steadyline®
MDT
Mini-Shaft™
Grooving
Parting-off
X4
Adapters and Clamping units
Accessories and Spare parts
Workpiece materials

DCBNR/L – Toolholders for inserts CNGG, CNMA, CNMG and CNMM – Metric

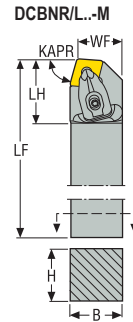

DCBNR/L..-M
KAPR = 75,0 °

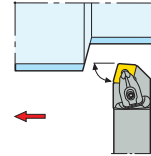

CTWS







- For inserts program, see page(s) 527, 528, 529, 530, 531, 532, 533
- GAMO° = Rake angle, LAMS° = Inclination angle
- CTWS = Insert shape and size
- For holder code key, see page(s) 15-16
- Shim DCN120416 for insert CN..1206.., to be ordered separately
- Right-hand version shown
- Please check availability at www.secotools.com / Seco Online Store

Designation	Item number	H	B	LF	WF	LH	KAPR°	GAMO°	LAMS°	Weight	CTWS
		mm	mm	mm	mm	mm				kg	
DCBNR2020K12-M	02588094	20	20	125	17,0	32,0	75,0	-6,0	-6,0	0,4	CN..1204..
DCBNR2525M12-M	02588095	25	25	150	22,0	31,0	75,0	-6,0	-6,0	0,8	CN..1204..
DCBNR3225P12-M	02588096	32	25	170	22,0	31,0	75,0	-6,0	-6,0	1,1	CN..1204..
DCBNL2020K12-M	02588097	20	20	125	17,0	32,0	75,0	-6,0	-6,0	0,4	CN..1204..
DCBNL2525M12-M	02588098	25	25	150	22,0	31,0	75,0	-6,0	-6,0	0,8	CN..1204..
DCBNL3225P12-M	02588099	32	25	170	22,0	31,0	75,0	-6,0	-6,0	1,1	CN..1204..
DCBNR2525M16-M	02588100	25	25	150	22,0	41,0	75,0	-6,0	-6,0	0,8	CN..1606..
DCBNR3225P16-M	02588101	32	25	170	22,0	42,0	75,0	-6,0	-6,0	1,1	CN..1606..
DCBNL2525M16-M	02588102	25	25	150	22,0	41,0	75,0	-6,0	-6,0	0,8	CN..1606..
DCBNL3225P16-M	02588103	32	25	170	22,0	42,0	75,0	-6,0	-6,0	1,1	CN..1606..
DCBNR3232P19-M	02588104	32	32	170	27,0	41,0	75,0	-6,0	-6,0	1,4	CN..1906..
DCBNR4040R19-M	02588105	40	40	200	35,0	42,0	75,0	-6,0	-6,0	2,5	CN..1906..
DCBNL3232P19-M	02588106	32	32	170	27,0	41,0	75,0	-6,0	-6,0	1,4	CN..1906..
DCBNL4040R19-M	02588107	40	40	200	35,0	42,0	75,0	-6,0	-6,0	2,5	CN..1906..

Spare Parts

For size	Clamp pin	Clamp screw	Floating wedge clamp	Insert shim	Shim/clamp key	Shim screw	Spring
...12	FP2012	L85021-T15P	CD12-S	DCN120616	T15P-7	C04008-T15P	S6912
...16	FP2012	L86026-T20P	CD16-S	DCN160616	T20P-7L	C05010-T20P	S7010
...19	FP2012	L86026-T20P	CD19-S	DCN190416	T20P-7L	C05010-T20P	S7010

Accessories

For size	Clamp kit	Insert clamping torque	Replacement blade	Torque key
...12	 CD12-S12	 3.5NM	 T00-15P	 T00-15P35
...16	CD16-S16	6.0NM	T00T-20P	T00T-20P60
...19	CD19-S19	6.0NM	T00T-20P	T00T-20P60

General ISO Turning
Holders

Steadyline®

MDT

Mini-Shaft™

Grooving

Parting-off

X4

Adapters
Clamping units

Accessories and
Spare parts

Workpiece
materials

DCKNR/L – Toolholders for inserts CNGG, CNMA, CNMG and CNMM – Metric

General ISO Turning
Holders

Steadyline®

MDT

Mini-Shaft™

Grooving

Parting-off

X4

Adapters
Clamping units

Accessories and
Spare parts

Workpiece
materials



CTWS



- For inserts program, see page(s) 527, 528, 529, 530, 531, 532, 533
- GAMO° = Rake angle, LAMS° = Inclination angle
- CTWS = Insert shape and size
- For holder code key, see page(s) 15-16
- Shim DCN120416 for insert CN..1206.., to be ordered separately
- Right-hand version shown
- Please check availability at www.secotools.com / Seco Online Store

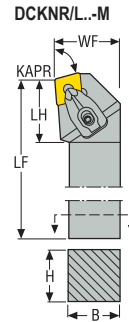

DCKNR/L..-M
KAPR = 75,0 °

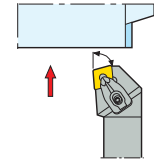

Designation	Item number	H	B	LF	WF	LH	KAPR°	GAMO°	LAMS°	Weight	CTWS
		mm	mm	mm	mm	mm				kg	
DCKNR2020K12-M	02588110	20	20	125	25,0	30,0	75,0	-6,0	-6,0	0,5	CN..1204..
DCKNR2525M12-M	02588111	25	25	150	32,0	31,0	75,0	-6,0	-6,0	0,8	CN..1204..
DCKNR3225P12-M	02588112	32	25	170	32,0	31,0	75,0	-6,0	-6,0	1,1	CN..1204..
DCKNL2020K12-M	02588113	20	20	125	25,0	30,0	75,0	-6,0	-6,0	0,5	CN..1204..
DCKNL2525M12-M	02588114	25	25	150	32,0	31,0	75,0	-6,0	-6,0	0,8	CN..1204..
DCKNL3225P12-M	02588115	32	25	170	32,0	31,0	75,0	-6,0	-6,0	1,1	CN..1204..
DCKNR2525M16-M	02588116	25	25	150	32,0	36,0	75,0	-6,0	-6,0	0,8	CN..1606..
DCKNR3225P16-M	02588117	32	25	170	32,0	36,0	75,0	-6,0	-6,0	1,2	CN..1606..
DCKNL2525M16-M	02588118	25	25	150	32,0	36,0	75,0	-6,0	-6,0	0,8	CN..1606..
DCKNL3225P16-M	02588119	32	25	170	32,0	36,0	75,0	-6,0	-6,0	1,2	CN..1606..
DCKNR3232P19-M	02588121	32	32	170	40,0	36,0	75,0	-6,0	-6,0	1,5	CN..1906..
DCKNL3232P19-M	02588123	32	32	170	40,0	36,0	75,0	-6,0	-6,0	1,5	CN..1906..

Spare Parts

For size	Clamp pin	Clamp screw	Floating wedge clamp	Insert shim	Shim/clamp key	Shim screw	Spring
...12	FP2012	L85021-T15P	CD12-S	DCN120616	T15P-7	C04008-T15P	S6912
...16	FP2012	L86026-T20P	CD16-S	DCN160616	T20P-7L	C05010-T20P	S7010
...19	FP2012	L86026-T20P	CD19-S	DCN190416	T20P-7L	C05010-T20P	S7010

Accessories

For size	Clamp kit	Insert clamping torque	Replacement blade	Torque key
...12	CD12-S12	3.5NM	T00-15P	T00-15P35
...16	CD16-S16	6.0NM	T00T-20P	T00T-20P60
...19	CD19-S19	6.0NM	T00T-20P	T00T-20P60

DCKNR/L – Toolholders for inserts CNGA, CNGP, CNMA, CNMG, CNMM and CNMP – Inch

DCKNR/L
KAPR = 75,0°

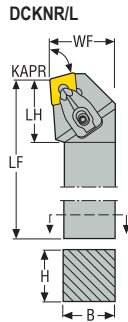
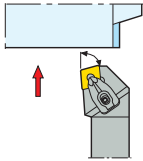

- For inserts program, see page(s) 527, 528, 529, 530, 531, 532, 533, 575, 576
- GAMO° = Rake angle, LAMS° = Inclination angle
- CTWS = Insert shape and size
- For holder code key, see page(s) 17-18
- Shim DCN120416 for insert CN..1206..., to be ordered separately
- Right-hand version shown
- Please check availability at www.secotools.com / Seco Online Store

Designation	Item number	H	B	LF	WF	LH	KAPR°	GAMO°	LAMS°	Weight	CTWS
		Inch	Inch	Inch	Inch	Inch				lbs	
DCKNR-16-4D	02565475	1.000	1.000	6.000	1.250	1.299	75,0	-6,0	-6,0	1.980	CN..43.
DCKNR-20-4D	02565476	1.250	1.250	6.000	1.500	1.299	75,0	-6,0	-6,0	2.870	CN..43.
DCKNL-16-4D	02565479	1.000	1.000	6.000	1.250	1.299	75,0	-6,0	-6,0	1.980	CN..43.
DCKNL-20-4D	02565480	1.250	1.250	6.000	1.500	1.299	75,0	-6,0	-6,0	2.870	CN..43.
DCKNR-16-5D	02565481	1.000	1.000	6.000	1.250	1.535	75,0	-6,0	-6,0	1.980	CN..54.
DCKNL-16-5D	02565483	1.000	1.000	6.000	1.250	1.654	75,0	-6,0	-6,0	1.980	CN..54.

Spare Parts

For size	Clamp pin	Clamp screw	Floating wedge clamp	Insert shim	Shim/clamp key	Shim screw	Spring
..-16-4	FP2012	L85021-T15P	CD12-S	DCN444	T15P-7	C04008-T15P	S6912
..-20	FP2012	L85021-T15P	CD12-S	DCN444	T15P-7	C04008-T15P	S6912
..-16-5	FP2012	L86026-T20P	CD16-S	DCN544	T20P-7L	C05010-T20P	S7010

Accessories

For size	Clamp kit	Insert clamping torque	Replacement blade	Torque key
..-16-4	CD12-S12	31.0IN.LBS	T00-15P	T00-15P35
..-20	CD12-S12	31.0IN.LBS	T00-15P	T00-15P35
..-16-5	CD16-S16	53.1IN.LBS	T00T-20P	T00T-20P60

DCLNR/L – Toolholders for inserts CNGA, CNGG, CNMA, CNMG and CNMM – Metric

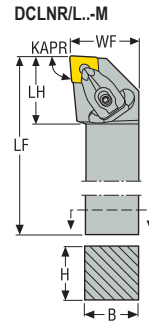

DCLNR/L..-M
KAPR = 95,0 °

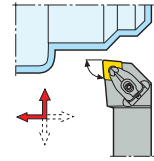













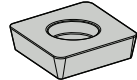











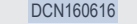

CTWS















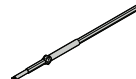

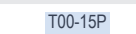

- For inserts program, see page(s) 527, 528, 529, 530, 531, 532, 533, 575, 576
- GAMO° = Rake angle, LAMS° = Inclination angle
- CTWS = Insert shape and size
- For holder code key, see page(s) 15-16
- Shim DCN120416 for insert CN..1206.., to be ordered separately
- Right-hand version shown
- Please check availability at www.secotools.com / Seco Online Store

Designation	Item number	H	B	LF	WF	LH	KAPR°	GAMO°	LAMS°	Weight	CTWS
		mm	mm	mm	mm	mm				kg	
DCLNR1616H09-M	02587765	16	16	100	20,0	25,0	95,0	-6,0	-6,0	0,3	CN..0903..
DCLNR2020K09-M	02588069	20	20	125	25,0	23,0	95,0	-6,0	-6,0	0,4	CN..0903..
DCLNR2525M09-M	02588070	25	25	150	32,0	25,0	95,0	-6,0	-6,0	0,8	CN..0903..
DCLNL1616H09-M	02588071	16	16	100	20,0	25,0	95,0	-6,0	-6,0	0,3	CN..0903..
DCLNL2525M09-M	02588073	25	25	150	32,0	25,0	95,0	-6,0	-6,0	0,8	CN..0903..
DCLNL2020K09-M	02588072	20	20	125	25,0	23,0	95,0	-6,0	-6,0	0,4	CN..0903..
DCLNR2020K12-M	02588074	20	20	125	25,0	32,0	95,0	-6,0	-6,0	0,4	CN..1204..
DCLNR2525M12-M	02588075	25	25	150	32,0	32,0	95,0	-6,0	-6,0	0,8	CN..1204..
DCLNR3225P12-M	02588076	32	25	170	32,0	32,0	95,0	-6,0	-6,0	1,1	CN..1204..
DCLNR3232P12-M	02588077	32	32	170	40,0	32,0	95,0	-6,0	-6,0	1,4	CN..1204..
DCLNL2020K12-M	02588078	20	20	125	25,0	32,0	95,0	-6,0	-6,0	0,4	CN..1204..
DCLNL2525M12-M	02588079	25	25	150	32,0	32,0	95,0	-6,0	-6,0	0,8	CN..1204..
DCLNL3225P12-M	02588080	32	25	170	32,0	32,0	95,0	-6,0	-6,0	1,1	CN..1204..
DCLNL3232P12-M	02588081	32	32	170	40,0	32,0	95,0	-6,0	-6,0	1,4	CN..1204..
DCLNR2525M16-M	02588082	25	25	150	32,0	40,0	95,0	-6,0	-6,0	0,8	CN..1606..
DCLNR3225P16-M	02588083	32	25	170	32,0	42,0	95,0	-6,0	-6,0	1,1	CN..1606..
DCLNR3232P16-M	02588084	32	32	170	40,0	42,0	95,0	-6,0	-6,0	1,4	CN..1606..
DCLNL2525M16-M	02588085	25	25	150	32,0	40,0	95,0	-6,0	-6,0	0,8	CN..1606..
DCLNL3225P16-M	02588086	32	25	170	32,0	42,0	95,0	-6,0	-6,0	1,1	CN..1606..
DCLNL3232P16-M	02588087	32	32	170	40,0	42,0	95,0	-6,0	-6,0	1,4	CN..1606..
DCLNR3232P19-M	02588089	32	32	170	40,0	42,0	95,0	-6,0	-6,0	1,4	CN..1906..
DCLNR4040R19-M	02588090	40	40	200	50,0	40,0	95,0	-6,0	-6,0	2,5	CN..1906..
DCLNL3232P19-M	02588092	32	32	170	40,0	42,0	95,0	-6,0	-6,0	1,4	CN..1906..
DCLNL4040R19-M	02588093	40	40	200	50,0	40,0	95,0	-6,0	-6,0	2,5	CN..1906..

Spare Parts

For size	Clamp pin	Clamp screw	Floating wedge clamp	Insert shim	Shim/clamp key	Shim screw	Spring
...09	 FP1508	 L84017-T09P	 CD09-S	 DCN090310	 T09P-2	 C03007-T09P	 S5608
...12	 FP2012	 L85021-T15P	 CD12-S	 DCN120616	 T15P-7	 C04008-T15P	 S6912
...16	 FP2012	 L86026-T20P	 CD16-S	 DCN160616	 T20P-7L	 C05010-T20P	 S7010
...19	 FP2012	 L86026-T20P	 CD19-S	 DCN190416	 T20P-7L	 C05010-T20P	 S7010

Accessories

For size	Clamp kit	Insert clamping torque	Replacement blade	Torque key
...09	 CD09-S09	 2.0NM	 T00-09P	 T00-09P20
...12	 CD12-S12	 3.5NM	 T00-15P	 T00-15P35
...16	 CD16-S16	 6.0NM	 T00T-20P	 T00T-20P60
...19	 CD19-S19	 6.0NM	 T00T-20P	 T00T-20P60

General ISO Turning Holders
Steadyline®
MDT
Mini-Shaft™
Grooving
Parting-off
X4
Adapters Clamping units
Accessories and Spare parts
Workpiece materials

DCLNR/L – Toolholders for inserts CNGA, CNGP, CNMA, CNMG, CNMM and CNMP – Inch

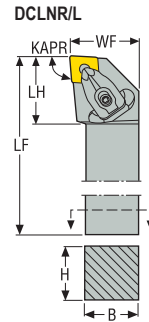

DCLNR/L
KAPR = 95,0 °

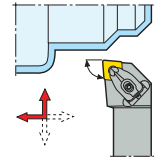













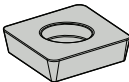







CTWS





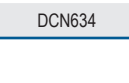

- For inserts program, see page(s) 527, 528, 529, 530, 531, 532, 533, 575, 576
- GAMO° = Rake angle, LAMS° = Inclination angle
- CTWS = Insert shape and size
- For holder code key, see page(s) 17-18
- Shim DCN120416 for insert CN..1206.., to be ordered separately
- Right-hand version shown
- Please check availability at www.secotools.com / Seco Online Store

Designation	Item number	H	B	LF	WF	LH	KAPR°	GAMO°	LAMS°	Weight lbs	CTWS
		Inch	Inch	Inch	Inch	Inch					
DCLNR-12-4B	02564754	0.750	0.750	4.500	1.000	1.299	95,0	-6,0	-6,0	0.880	CN..43.
DCLNR-16-4D	02569284	1.000	1.000	6.000	1.250	1.299	95,0	-6,0	-6,0	1.980	CN..43.
DCLNR-20-4D	02588893	1.250	1.250	6.000	1.500	1.299	95,0	-6,0	-6,0	2.870	CN..43.
DCLNR-24-4D	02565454	1.500	1.500	6.000	2.000	1.299	95,0	-6,0	-6,0	3.970	CN..43.
DCLNL-12-4B	02565455	0.750	0.750	4.500	1.000	1.299	95,0	-6,0	-6,0	0.880	CN..43.
DCLNL-16-4D	02569285	1.000	1.000	6.000	1.250	1.299	95,0	-6,0	-6,0	1.980	CN..43.
DCLNL-20-4D	02565458	1.250	1.250	6.000	1.500	1.299	95,0	-6,0	-6,0	2.870	CN..43.
DCLNL-24-4D	02565459	1.500	1.500	6.000	2.000	1.299	95,0	-6,0	-6,0	4.190	CN..43.
DCLNR-16-5D	02565460	1.000	1.000	6.000	1.250	1.654	95,0	-6,0	-6,0	1.980	CN..54.
DCLNR-20-5D	02565461	1.250	1.250	6.000	1.500	1.575	95,0	-6,0	-6,0	2.870	CN..54.
DCLNL-16-5D	02565464	1.000	1.000	6.000	1.250	1.654	95,0	-6,0	-6,0	1.980	CN..54.
DCLNL-20-5D	02565465	1.250	1.250	6.000	1.500	1.575	95,0	-6,0	-6,0	2.870	CN..54.
DCLNR-20-6D	02565468	1.250	1.250	6.000	1.500	1.339	95,0	-6,0	-6,0	2.870	CN..64.
DCLNR-24-6D	02565469	1.500	1.500	6.000	2.000	1.654	95,0	-6,0	-6,0	3.970	CN..64.
DCLNL-20-6D	02565471	1.250	1.250	6.000	1.500	1.339	95,0	-6,0	-6,0	2.870	CN..64.
DCLNL-24-6D	02565472	1.500	1.500	6.000	2.000	1.654	95,0	-6,0	-6,0	3.970	CN..64.

Spare Parts

For size	Clamp pin	Clamp screw	Floating wedge clamp	Insert shim	Shim/clamp key	Shim screw	Spring
...4	 FP2012	 L85021-T15P	 CD12-S	 DCN444	 T15P-7	 C04008-T15P	 S6912
...5	 FP2012	 L86026-T20P	 CD16-S	 DCN544	 T20P-7L	 C05010-T20P	 S7010
...6	 FP2012	 L86026-T20P	 CD19-S	 DCN634	 T20P-7L	 C05010-T20P	 S7010

Accessories

For size	Clamp kit	Insert clamping torque	Replacement blade	Torque key
..4	 CD12-S12	 31.0IN.LBS	 T00-15P	 T00-15P35
..5	CD16-S16	53.1IN.LBS	T00T-20P	T00T-20P60
..6	CD19-S19	53.1IN.LBS	T00T-20P	T00T-20P60

General ISO Turning
Holders

Steadyline®

MDT

Mini-Shaft™

Grooving

Parting-off

X4

Adapters
Clamping units

Accessories and
Spare parts

Workpiece
materials

DDHNR/L – Toolholders for inserts DNGA, DNGG, DNGM, DNMA, DNMG, DNMM, DNMU and DNMX – Metric

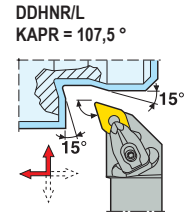
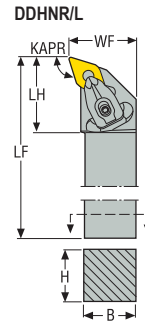

CTWS



- For inserts program, see page(s) 537, 538, 539, 540, 541, 579, 580, 598
- GAMO° = Rake angle, LAMS° = Inclination angle
- CTWS = Insert shape and size
- For holder code key, see page(s) 15-16
- Right-hand version shown
- * Use the right shim & the right screw for the selected insert. For details, see page 99
- Please check availability at www.secotools.com / Seco Online Store

Designation	Item number	H	B	LF	WF	LH	KAPR°	GAMO°	LAMS°	Weight	CTWS
		mm	mm	mm	mm	mm				kg	
DDHNR1616H11	02588124	16	16	100	20,0	26,0	107,5	-6,0	-6,0	0,2	DN..1104..
DDHNR2020K11	02588125	20	20	125	25,0	26,0	107,5	-6,0	-6,0	0,4	DN..1104..
DDHNR2525M11	02588126	25	25	150	32,0	26,0	107,5	-6,0	-6,0	0,8	DN..1104..
DDHNL1616H11	02588127	16	16	100	20,0	26,0	107,5	-6,0	-6,0	0,2	DN..1104..
DDHNL2020K11	02588128	20	20	125	25,0	26,0	107,5	-6,0	-6,0	0,4	DN..1104..
DDHNL2525M11	02588129	25	25	150	32,0	26,0	107,5	-6,0	-6,0	0,8	DN..1104..
DDHNR2020K15	02588130	20	20	125	25,0	32,0	107,5	-6,0	-6,0	0,4	DN.1504/DN..1506*
DDHNR2525M15	02588131	25	25	150	32,0	36,0	107,5	-6,0	-6,0	0,8	DN.1504/DN..1506*
DDHNR3232P15	02588132	32	32	170	40,0	33,0	107,5	-6,0	-6,0	1,3	DN.1504/DN..1506*
DDHNL2020K15	02588133	20	20	125	25,0	32,0	107,5	-6,0	-6,0	0,4	DN.1504/DN..1506*
DDHNL2525M15	02588134	25	25	150	32,0	36,0	107,5	-6,0	-6,0	0,8	DN.1504/DN..1506*
DDHNL3232P15	02588135	32	32	170	40,0	33,0	107,5	-6,0	-6,0	1,3	DN.1504/DN..1506*

Spare Parts

For size	Clamp pin	Clamp screw	Floating wedge clamp	Insert shim	Shim/clamp key	Shim screw	Spring
...11	FP1508	L84017-T09P	CD09-S	DDN110310	T09P-2	C03007-T09P	S5608
...15	FP2012	L85021-T15P	CD12-S	DDN150416	T15P-7	C04008-T15P	S6912

Accessories

For size	Clamp kit	Insert clamping torque	Replacement blade	Torque key
...11	CD09-S09	2.0NM	T00-09P	T00-09P20
...15	CD12-S12	3.5NM	T00-15P	T00-15P35

DDJNR/L – Toolholders for inserts DNGA, DNGG, DNGM, DNMA, DNMG, DNMM, DNMU and DNMX – Metric

DDJNR/L, ...-M
KAPR = 93,0°

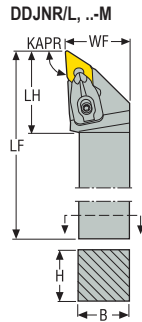
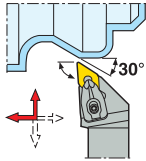

- For inserts program, see page(s) 537, 538, 539, 540, 541, 579, 580, 598
- GAMO° = Rake angle, LAMS° = Inclination angle
- CTWS = Insert shape and size
- For holder code key, see page(s) 15-16
- Right-hand version shown
- * Use the right shim & the right screw for the selected insert. For details, see page 99
- Please check availability at www.secotools.com / Seco Online Store

Designation	Item number	H	B	LF	WF	LH	KAPR°	GAMO°	LAMS°	Weight	CTWS
		mm	mm	mm	mm	mm				kg	
DDJNR1616H11	02588136	16	16	100	20,0	31,0	93,0	-6,0	-6,0	0,2	DN.. 1104..
DDJNR2020K11	02588137	20	20	125	25,0	31,0	93,0	-6,0	-6,0	0,4	DN.. 1104..
DDJNR2525M11	02588138	25	25	150	32,0	31,0	93,0	-6,0	-6,0	0,7	DN.. 1104..
DDJNR3225P11	02588139	32	25	170	32,0	31,0	93,0	-6,0	-6,0	1,1	DN.. 1104..
DDJNL1616H11	02588140	16	16	100	20,0	31,0	93,0	-6,0	-6,0	0,2	DN.. 1104..
DDJNL2020K11	02588141	20	20	125	25,0	31,0	93,0	-6,0	-6,0	0,4	DN.. 1104..
DDJNL2525M11	02588142	25	25	150	32,0	31,0	93,0	-6,0	-6,0	0,7	DN.. 1104..
DDJNL3225P11	02588143	32	25	170	32,0	31,0	93,0	-6,0	-6,0	1,1	DN.. 1104..
DDJNR2020K15-M	02588144	20	20	125	25,0	42,0	93,0	-6,0	-6,0	0,4	DN.1504/DN..1506*
DDJNR2525M15-M	02588145	25	25	150	32,0	42,0	93,0	-6,0	-6,0	0,8	DN.1504/DN..1506*
DDJNR3225P15-M	02588146	32	25	170	32,0	42,0	93,0	-6,0	-6,0	1,1	DN.1504/DN..1506*
DDJNR3232P15-M	02588147	32	32	170	40,0	42,0	93,0	-6,0	-6,0	1,4	DN.1504/DN..1506*
DDJNL2020K15-M	02588149	20	20	125	25,0	42,0	93,0	-6,0	-6,0	0,4	DN.1504/DN..1506*
DDJNL2525M15-M	02588150	25	25	150	32,0	42,0	93,0	-6,0	-6,0	0,8	DN.1504/DN..1506*
DDJNL3225P15-M	02588151	32	25	170	32,0	42,0	93,0	-6,0	-6,0	1,1	DN.1504/DN..1506*
DDJNL3232P15-M	02588152	32	32	170	40,0	42,0	93,0	-6,0	-6,0	1,4	DN.1504/DN..1506*

Spare Parts

For size	Clamp pin	Clamp screw	Floating wedge clamp	Insert shim	Shim/clamp key	Shim screw	Spring
...11	FP1508	L84017-T09P	CD09-S	DDN110310	T09P-2	C03007-T09P	S5608
...15	FP2012	L85021-T15P	CD12-S	DDN150416	T15P-7	C04008-T15P	S6912

Accessories

For size	Clamp kit	Insert clamping torque	Replacement blade	Torque key
...11	CD09-S09	2.0NM	T00-09P	T00-09P20
...15	CD12-S12	3.5NM	T00-15P	T00-15P35

DDJNR/L, -M – Toolholders for inserts DNGA, DNGM, DNGP, DNMA, DNMG, DNMP, DNMU and DNMX – Inch

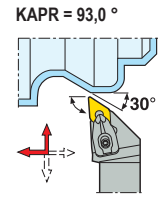
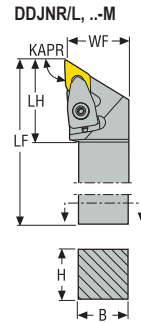

CTWS



- For inserts program, see page(s) 537, 538, 539, 540, 541, 579, 580, 598
- GAMO° = Rake angle, LAMS° = Inclination angle
- CTWS = Insert shape and size
- For holder code key, see page(s) 17-18
- Right-hand version shown
- * Use the right shim & the right screw for the selected insert. For details, see page 99
- Please check availability at www.secotools.com / Seco Online Store

Designation	Item number	H	B	LF	WF	LH	KAPR°	GAMO°	LAMS°	Weight	CTWS
		Inch	Inch	Inch	Inch	Inch					
DDJNR-10-3A	02565487	0.625	0.625	4.000	0.875	1.181	93,0	-6,0	-6,0	0.660	DN..33.
DDJNR-12-3B	02565488	0.750	0.750	4.500	1.000	1.181	93,0	-6,0	-6,0	0.880	DN..33.
DDJNR-16-3D	02565490	1.000	1.000	6.000	1.250	1.181	93,0	-6,0	-6,0	1.760	DN..33.
DDJNL-10-3A	02565492	0.625	0.625	4.000	0.875	1.181	93,0	-6,0	-6,0	0.660	DN..33.
DDJNL-12-3B	02565493	0.750	0.750	4.500	1.000	1.181	93,0	-6,0	-6,0	0.880	DN..33.
DDJNL-16-3D	02565495	1.000	1.000	6.000	1.250	1.181	93,0	-6,0	-6,0	1.760	DN..33.
DDJNR-12-4B	02565497	0.750	0.750	4.500	1.000	1.654	93,0	-6,0	-6,0	0.880	DN..43/DN..44*
DDJNR-16-4D-M	02569288	1.000	1.000	6.000	1.250	1.654	93,0	-6,0	-6,0	1.760	DN..43/DN..44*
DDJNR-20-4D	02565500	1.250	1.250	6.000	1.500	1.654	93,0	-6,0	-6,0	2.430	DN..43/DN..44*
DDJNL-12-4B	02565502	0.750	0.750	4.500	1.000	1.654	93,0	-6,0	-6,0	0.880	DN..43/DN..44*
DDJNL-16-4D-M	02569289	1.000	1.000	6.000	1.250	1.654	93,0	-6,0	-6,0	1.760	DN..43/DN..44*
DDJNL-20-4D	02565505	1.250	1.250	6.000	1.500	1.654	93,0	-6,0	-6,0	2.430	DN..43/DN..44*

Spare Parts

For size	Clamp pin	Clamp screw	Floating wedge clamp	Insert shim	Shim/clamp key	Shim screw	Spring
..-3	FP1508	L84017-T09P	CD09-S	DDN322.5	T09P-2	C03007-T09P	S5608
..-4	FP2012	L85021-T15P	CD12-S	DDN444	T15P-7	C04011-T15P	S6912

Accessories

For size	Clamp kit	Insert clamping torque	Replacement blade	Torque key
..-3	CD09-S09	17.7IN.LBS	T00-09P	T00-09P20
..-4	CD12-S12	31.0IN.LBS	T00-15P	T00-15P35

DDJNR/L and DDNNN – Toolholders for PCBN inserts DNMA – Metric

DDJNR/L..-C
KAPR = 93,0°

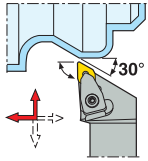

DDNNN..-C
KAPR = 62,5°

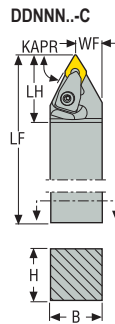
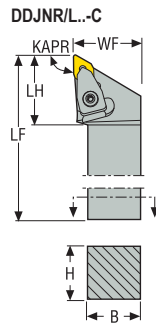
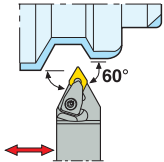

- For inserts program, see page(s) 537, 538, 539, 540, 541, 580
- GAMO° = Rake angle, LAMS° = Inclination angle
- CTWS = Insert shape and size
- For holder code key, see page(s) 15-16
- DDJNR/L = Right-hand version shown
- DDNNN = Neutral version shown
- Please check availability at www.secotools.com / Seco Online Store

Designation	Item number	H	B	LF	WF	LH	KAPR°	GAMO°	LAMS°	Weight	CTWS
		mm	mm	mm	mm	mm				kg	
DDJNR3225P11-C	02598519	32	25	170	32,0	32,0	93,0	-6,0	-6,0	1,1	DNMA1104..
DDJNL3225P11-C	02598524	32	25	170	32,0	32,0	93,0	-6,0	-6,0	1,1	DNMA1104..
DDNNN3225P11-C	02598525	32	25	170	32,0	33,0	62,5	-9,0	-5,0	1,0	DNMA1104..

Spare Parts

For size	Clamp pin	Clamp screw	Floating wedge clamp	Insert shim	Shim/clamp key	Shim screw	Spring
...11	FP1508	L84017-T09P	CC09P-D11	DDN110310	T09P-2	C03007-T09P	S5608

Accessories

For size	Clamp kit	Insert clamping torque	Replacement blade	Torque key
...11	CC09P-SET	2.0NM	T00-09P	T00-09P20

General ISO Turning
Holders

Steadyline®

MDT

Mini-Shaft™

Grooving

Parting-off

X4

Adapters
Clamping units

Accessories and
Spare parts

Workpiece
materials

DDPNN – Toolholders for inserts DNGA, DNGM, DNGP, DNMA, DNMG, DNMP and DNMU – Inch

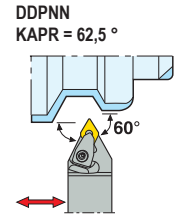
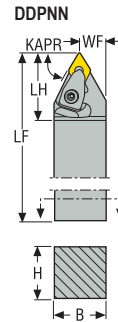

CTWS



- For inserts program, see page(s) 537, 538, 539, 540, 541, 579, 580, 598
- GAMO° = Rake angle, LAMS° = Inclination angle
- CTWS = Insert shape and size
- For holder code key, see page(s) 17-18
- Right-hand version shown
- * Use the right shim & the right screw for the selected insert. For details, see page 99
- Please check availability at www.secotools.com / Seco Online Store

Designation	Item number	H	B	LF	WF	LH	KAPR°	GAMO°	LAMS°	Weight	CTWS
		Inch	Inch	Inch	Inch	Inch				lbs	
DDPNN-16-3D	02565509	1.000	1.000	6.000	0.500	1.102	62,5	0,0	-10,0	1.760	DN..33.
DDPNN-16-4D	02565512	1.000	1.000	6.000	0.500	1.693	62,5	0,0	-10,0	1.760	DN..43/DN..44*
DDPNN-20-4D	02565513	1.250	1.250	6.000	0.625	1.693	62,5	0,0	-10,0	2.430	DN..43/DN..44*

Spare Parts

For size	Clamp pin	Clamp screw	Floating wedge clamp	Insert shim	Shim/clamp key	Shim screw	Spring
..-3	FP1508	L84017-T09P	CD09-S	DDN322.5	T09P-2	C03007-T09P	S5608
..-4	FP2012	L85021-T15P	CD12-S	DDN444	T15P-7	C04008-T15P	S6912

Accessories

For size	Clamp kit	Insert clamping torque	Replacement blade	Torque key
..-3	CD09-S09	17.7IN.LBS	T00-09P	T00-09P20
..-4	CD12-S12	31.0IN.LBS	T00-15P	T00-15P35

DDQNR/L – Toolholders for inserts DNGA, DNGM, DNGP, DNMA, DNMG, DNMP, DNMU and DNMX – Inch

DDQNR/L
KAPR = 107,5 °

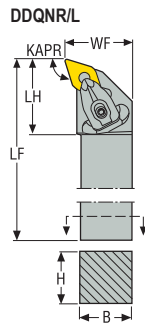
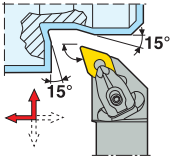

- For inserts program, see page(s) 537, 538, 539, 540, 541, 579, 580, 598
- GAMO° = Rake angle, LAMS° = Inclination angle
- CTWS = Insert shape and size
- For holder code key, see page(s) 17-18
- Right-hand version shown
- * Use the right shim & the right screw for the selected insert. For details, see page 99
- Please check availability at www.secotools.com / Seco Online Store

Designation	Item number	H	B	LF	WF	LH	KAPR°	GAMO°	LAMS°	Weight	CTWS
		Inch	Inch	Inch	Inch	Inch				lbs	
DDQNR-16-3D	02880410	1.000	1.000	6.000	1.250	1.181	107,5	-6,0	-6,0	1.760	DN..33.
DDQNL-16-3D	02880408	1.000	1.000	6.000	1.250	1.181	107,5	-6,0	-6,0	1.760	DN..33.
DDQNR-16-4D	02904201	1.000	1.000	6.000	1.260	1.378	107,5	-6,0	-6,0	1.760	DN..43/DN..44*
DDQNL-16-4D	02904200	1.000	1.000	6.000	1.260	1.378	107,5	-6,0	-6,0	1.760	DN..43/DN..44*

Spare Parts

For size	Clamp pin	Clamp screw	Floating wedge clamp	Insert shim	Shim/clamp key	Shim screw	Spring
..-3	FP1508	L84017-T09P	CD09-S	DDN322.5	T09P-2	C03007-T09P	S5608
..-4	FP2012	L85021-T15P	CD12-S	DDN434	T15P-7	C04008-T15P	S6912

Accessories

For size	Clamp kit	Insert clamping torque	Replacement blade	Torque key
..-3	CD09-S09	17.7IN.LBS	T00-09P	T00-09P20
..-4	CD12-S12	31.0IN.LBS	T00-15P	T00-15P35

General ISO Turning
Holders

Steadyline®

MDT

Mini-Shaft™

Grooving

Parting-off

X4

Adapters
Clamping units

Accessories and
Spare parts

Workpiece
materials

DRGNR/L – Toolholders for inserts RNM. – Inch

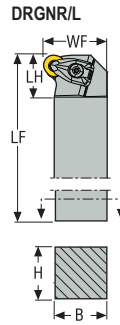

DRGNR/L
KAPR = 90,0 °

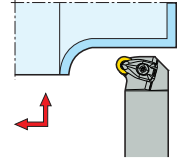

CTWS



- For inserts program, see page(s) 547, 583
- GAMO° = Rake angle, LAMS° = Inclination angle
- CTWS = Insert shape and size
- For holder code key, see page(s) 17-18
- Shim DSN120416 for insert SN..1206.., to be ordered separately
- Right-hand version shown
- Please check availability at www.secotools.com / Seco Online Store

Designation	Item number	H	B	LF	WF	LH	KAPR°	GAMO°	LAMS°	Weight	CTWS
		Inch	Inch	Inch	Inch	Inch				lbs	
DRGNR-16-4D	02565514	1.000	1.000	6.000	1.250	1.181	90,0	-6,0	-6,0	1.980	RNM.43
DRGNL-16-4D	02565516	1.000	1.000	6.000	1.250	1.181	90,0	-6,0	-6,0	1.980	RNM.43

Spare Parts

For size	Clamp pin	Clamp screw	Floating wedge clamp	Insert shim	Shim/clamp key	Shim screw	Spring
..4	FP2012	L85021-T15P	CD12-S	DRN44	T15P-7	C04008-T15P	S6912

Accessories

For size	Clamp kit	Insert clamping torque	Replacement blade	Torque key
..4	CD12-S12	31.0IN.LBS	T00-15P	T00-15P35

General ISO Turning Holders
Steadyline®
MDT
Mini-Shaft™
Grooving
Parting-off
X4
Adapters Clamping units
Accessories and Spare parts
Workpiece materials

DRSNR/L..-M – Toolholders for inserts RNMA and RNMG – Metric

DRSNR/L..-M
KAPR = 45,0°

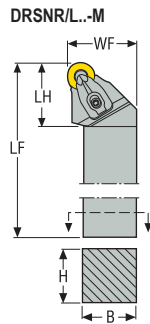
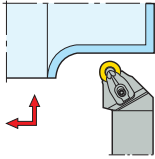

CTWS



- For inserts program, see page(s) 547
- GAMO° = Rake angle, LAMS° = Inclination angle
- CTWS = Insert shape and size
- For holder code key, see page(s) 15-16
- Right-hand version shown
- Please check availability at www.secotools.com / Seco Online Store

Designation	Item number	H	B	LF	WF	LH	KAPR°	GAMO°	LAMS°	Weight	CTWS
		mm	mm	mm	mm	mm				kg	
DRSNR2525M12-M	02588153	25	25	150	32,0	30,0	45,0	-6,0	-6,0	0,8	RN..120400
DRSNR3225P12-M	02588154	32	25	170	32,0	30,0	45,0	-6,0	-6,0	1,1	RN..120400
DRSNL2525M12-M	02588155	25	25	150	32,0	30,0	45,0	-6,0	-6,0	0,8	RN..120400
DRSNL3225P12-M	02588156	32	25	170	32,0	30,0	45,0	-6,0	-6,0	1,1	RN..120400

Spare Parts

For size	Clamp pin	Clamp screw	Floating wedge clamp	Insert shim	Shim/clamp key	Shim screw	Spring
...12	FP2012	L85021-T15P	CD12-S	DRN120600	T15P-7	C04008-T15P	S6912

Accessories

For size	Clamp kit	Insert clamping torque	Replacement blade	Torque key
...12	CD12-S12	3.5NM	T00-15P	T00-15P35

General ISO Turning
Holders

Steadyline®

MDT

Mini-Shaft™

Grooving

Parting-off

X4

Adapters
Clamping units

Accessories and
Spare parts

Workpiece
materials

DSBNR/L..-M – Toolholders for inserts SNGA, SNMA, SNMG and SNMM – Metric

General ISO Turning
Holders

Steadyline®

MDT

Mini-Shaft™

Grooving

Parting-off

X4

Adapters
Clamping units

Accessories and
Spare parts

Workpiece
materials

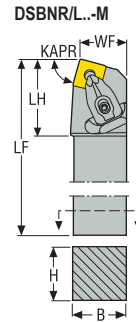

DSBNR/L..-M
KAPR = 75,0 °

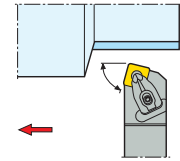

CTWS



- For inserts program, see page(s) 550, 551, 552, 553, 585
- GAMO° = Rake angle, LAMS° = Inclination angle
- CTWS = Insert shape and size
- For holder code key, see page(s) 15-16
- Shim DSN120416 for insert SN..1206.., to be ordered separately
- Right-hand version shown
- Please check availability at www.secotools.com / Seco Online Store

Designation	Item number	H	B	LF	WF	LH	KAPR°	GAMO°	LAMS°	Weight	CTWS
		mm	mm	mm	mm	mm				kg	
DSBNR2020K12-M	02588157	20	20	125	17,0	37,0	75,0	-6,0	-6,0	0,5	SN..1204..
DSBNR2525M12-M	02588158	25	25	150	22,0	36,0	75,0	-6,0	-6,0	0,8	SN..1204..
DSBNL2020K12-M	02588159	20	20	125	17,0	37,0	75,0	-6,0	-6,0	0,5	SN..1204..
DSBNL2525M12-M	02588160	25	25	150	22,0	36,0	75,0	-6,0	-6,0	0,8	SN..1204..
DSBNR2525M15-M	02588161	25	25	150	22,0	41,0	75,0	-6,0	-6,0	0,8	SN..1506..
DSBNR3232P15-M	02588163	32	32	170	27,0	42,0	75,0	-6,0	-6,0	1,4	SN..1506..
DSBNL2525M15-M	02588164	25	25	150	22,0	41,0	75,0	-6,0	-6,0	0,8	SN..1506..
DSBNL3232P15-M	02588166	32	32	170	27,0	42,0	75,0	-6,0	-6,0	1,4	SN..1506..

Spare Parts

For size	Clamp pin	Clamp screw	Floating wedge clamp	Insert shim	Shim/clamp key	Shim screw	Spring
...12	FP2012	L85021-T15P	CD12-S	DSN120616	T15P-7	C04008-T15P	S6912
...15	FP2012	L86026-T20P	CD16-S	DSN150624	T20P-7L	C05010-T20P	S7010

Accessories

For size	Clamp kit	Insert clamping torque	Replacement blade	Torque key
...12	CD12-S12	3.5NM	T00-15P	T00-15P35
...15	CD16-S16	6.0NM	T00T-20P	T00T-20P60

DSDNN..-M – Toolholders for inserts SNGA, SNMA, SNMG and SNMM – Metric

DSDNN..-M
KAPR = 45,0°

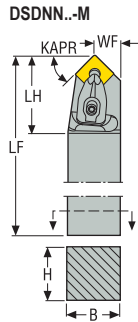
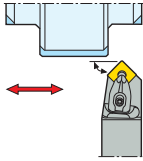

CTWS



- For inserts program, see page(s) 550, 551, 552, 553, 585
- GAMO° = Rake angle, LAMS° = Inclination angle
- CTWS = Insert shape and size
- For holder code key, see page(s) 15-16
- Shim DSN120416 for insert SN..1206..., to be ordered separately
- Neutral version shown
- Please check availability at www.secotools.com / Seco Online Store

Designation	Item number	H	B	LF	WF	LH	KAPR°	GAMO°	LAMS°	Weight	CTWS
		mm	mm	mm	mm	mm				kg	
DSDNN2020K12-M	02588189	20	20	125	10,3	37,0	45,0	-6,0	-6,0	0,4	SN..1204..
DSDNN2525M12-M	02588190	25	25	150	12,8	36,0	45,0	-6,0	-6,0	0,7	SN..1204..
DSDNN3232P12-M	02588191	32	32	170	16,3	36,0	45,0	-6,0	-6,0	1,3	SN..1204..

Spare Parts

For size	Clamp pin	Clamp screw	Floating wedge clamp	Insert shim	Shim/clamp key	Shim screw	Spring
...12	FP2012	L85021-T15P	CD12-S	DSN120616	T15P-7	C04008-T15P	S6912

Accessories

For size	Clamp kit	Insert clamping torque	Replacement blade	Torque key
...12	CD12-S12	3.5NM	T00-15P	T00-15P35

DSDNN – Toolholders for inserts SNGA, SNMA, SNMG and SNMM – Inch

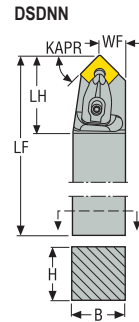

DSDNN
KAPR = 45,0 °

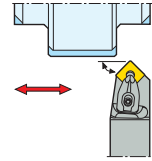

CTWS



- For inserts program, see page(s) 550, 551, 552, 553, 585
- GAMO° = Rake angle, LAMS° = Inclination angle
- CTWS = Insert shape and size
- For holder code key, see page(s) 17-18
- Shim DSN434 for insert SN..44., to be ordered separately
- Neutral version shown
- Please check availability at www.secotools.com / Seco Online Store

Designation	Item number	H	B	LF	LFS	WF	LH	KAPR°	GAMO°	LAMS°	Weight	CTWS
		Inch	Inch	Inch	Inch	Inch	Inch				lbs	
DSDNN-12-4B	02904197	0.750	0.750	4.500	4.173	0.386	1.260	45,0	-6,0	-6,0	0.880	SN..43.
DSDNN-16-4D	02904198	1.000	1.000	6.000	5.669	0.512	1.575	45,0	-6,0	-6,0	1.760	SN..43.
DSDNN-20-4D	02904199	1.250	1.250	6.000	5.674	0.638	1.575	45,0	-6,0	-6,0	2.430	SN..43.

Spare Parts

For size	Clamp pin	Clamp screw	Floating wedge clamp	Insert shim	Shim/clamp key	Shim screw	Spring
..-4	FP2012	L85021-T15P	CD12-S	DSN444	T15P-7	C04008-T15P	S6912

Accessories

For size	Clamp kit	Insert clamping torque	Replacement blade	Torque key
..-4	CD12-S12	31.0IN.LBS	T00-15P	T00-15P35

General ISO Turning Holders
Steadyline®
MDT
Mini-Shaft™
Grooving
Parting-off
X4
Adapters Clamping units
Accessories and Spare parts
Workpiece materials

DSKNR/L..-M – Toolholders for inserts SNGA, SNMA, SNMG and SNMM – Metric

DSKNR/L..-M
KAPR = 75,0°

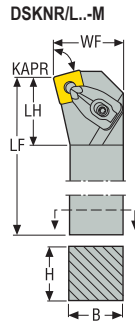
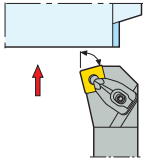

CTWS



- For inserts program, see page(s) 550, 551, 552, 553, 585
- GAMO° = Rake angle, LAMS° = Inclination angle
- CTWS = Insert shape and size
- For holder code key, see page(s) 15-16
- Shim DSN120416 for insert SN..1206... to be ordered separately
- Shim DSN190640 for insert SNMM190624W-R7, to be ordered separately
- Right-hand version shown
- Please check availability at www.secotools.com / Seco Online Store

Designation	Item number	H	B	LF	WF	LH	KAPR°	GAMO°	LAMS°	Weight	CTWS
		mm	mm	mm	mm	mm				kg	
DSKNR2020K12-M	02588192	20	20	125	25,0	33,0	75,0	-6,0	-6,0	0,5	SN..1204..
DSKNR2525M12-M	02588193	25	25	150	32,0	33,0	75,0	-6,0	-6,0	0,8	SN..1204..
DSKNR3225P12-M	02588194	32	25	170	32,0	35,0	75,0	-6,0	-6,0	1,1	SN..1204..
DSKNL2020K12-M	02588195	20	20	125	25,0	33,0	75,0	-6,0	-6,0	0,5	SN..1204..
DSKNL2525M12-M	02588196	25	25	150	32,0	33,0	75,0	-6,0	-6,0	0,8	SN..1204..
DSKNL3225P12-M	02588197	32	25	170	32,0	35,0	75,0	-6,0	-6,0	1,1	SN..1204..
DSKNR3232P19-M	02588198	32	32	170	40,0	37,0	75,0	-6,0	-6,0	1,5	SN..1906..
DSKNL3232P19-M	02588199	32	32	170	40,0	37,0	75,0	-6,0	-6,0	1,5	SN..1906..

Spare Parts

For size	Clamp pin	Clamp screw	Floating wedge clamp	Insert shim	Shim/clamp key	Shim screw	Spring
...12	FP2012	L85021-T15P	CD12-S	DSN120616	T15P-7	C04008-T15P	S6912
...19	FP2012	L86026-T20P	CD19-S	DSN190624	T20P-7L	C05010-T20P	S7010

Accessories

For size	Clamp kit	Insert clamping torque	Replacement blade	Torque key
...12	CD12-S12	3.5NM	T00-15P	T00-15P35
...19	CD19-S19	6.0NM	T00T-20P	T00T-20P60

DSKNR/L – Toolholders for inserts SNGA, SNMA, SNMG, SNMM and SNMP – Inch

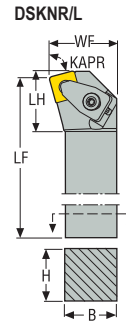

DSKNR/L
KAPR = 75,0 °

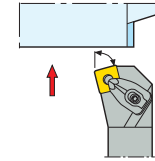

CTWS



- For inserts program, see page(s) 550, 551, 552, 553, 585
- GAMO° = Rake angle, LAMS° = Inclination angle
- CTWS = Insert shape and size
- For holder code key, see page(s) 17-18
- Shim DSN434 for insert SN..44., to be ordered separately
- Right-hand version shown
- Please check availability at www.secotools.com / Seco Online Store

Designation	Item number	H	B	LF	WF	LH	KAPR°	GAMO°	LAMS°	Weight	CTWS
		Inch	Inch	Inch	Inch	Inch				lbs	
DSKNR-12-4B	02565534	0.750	0.750	4.500	1.000	1.299	75,0	-6,0	-6,0	0.880	SN..43.
DSKNR-16-4D	02565535	1.000	1.000	6.000	1.250	1.378	75,0	-6,0	-6,0	1.980	SN..43.
DSKNL-12-4B	02565537	0.750	0.750	4.500	1.000	1.299	75,0	-6,0	-6,0	0.880	SN..43.
DSKNL-16-4D	02565538	1.000	1.000	6.000	1.250	1.378	75,0	-6,0	-6,0	1.980	SN..43.
DSKNR-16-5D	02565540	1.000	1.000	6.000	1.250	1.400	75,0	-6,0	-6,0	1.980	SN..54.
DSKNL-16-5D	02565542	1.000	1.000	6.000	1.250	1.400	75,0	-6,0	-6,0	1.980	SN..54.

Spare Parts

For size	Clamp pin	Clamp screw	Floating wedge clamp	Insert shim	Shim/clamp key	Shim screw	Spring
..-4	FP2012	L85021-T15P	CD12-S	DSN444	T15P-7	C04008-T15P	S6912
..-5	FP2012	L86026-T20P	CD16-S	DSN546	T20P-7L	C05010-T20P	S7010

Accessories

For size	Clamp kit	Insert clamping torque	Replacement blade	Torque key
..-4	CD12-S12	31.0IN.LBS	T00-15P	T00-15P35
..-5	CD16-S16	53.1IN.LBS	T00T-20P	T00T-20P60

DSSNR/L..-M – Toolholders for inserts SNGA, SNMA, SNMG and SNMM – Metric

DSSNR/L..-M
KAPR = 45,0°

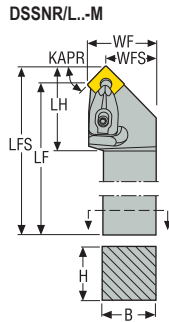
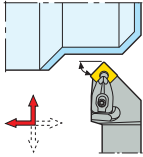

CTWS



- For inserts program, see page(s) 550, 551, 552, 553, 585
- GAMO° = Rake angle, LAMS° = Inclination angle
- CTWS = Insert shape and size
- For holder code key, see page(s) 15-16
- Shim DSN120416 for insert SN..1206... to be ordered separately
- Shim DSN190640 for insert SNMM190624W-R7, to be ordered separately
- Right-hand version shown
- Please check availability at www.secotools.com / Seco Online Store

Designation	Item number	H	B	LF	LFS	WF	WFS	LH	KAPR°	GAMO°	LAMS°	Weight	CTWS
		mm	mm	mm	mm	mm	mm	mm				kg	
DSSNR1616H09-M	02588167	16	16	101	107,1	20,0	14,1	32,0	45,0	-8,0	0,0	0,3	SN..0903..
DSSNR2020K09-M	02588168	20	20	125	132,1	25,0	19,1	32,0	45,0	-8,0	0,0	0,5	SN..0903..
DSSNR2525M09-M	02588169	25	25	150	157,1	32,0	26,1	32,0	45,0	-8,0	0,0	0,8	SN..0903..
DSSNL1616H09-M	02588170	16	16	101	107,1	20,0	14,1	32,0	45,0	-8,0	0,0	0,3	SN..0903..
DSSNL2525M09-M	02588172	25	25	150	157,1	32,0	26,1	32,0	45,0	-8,0	0,0	0,8	SN..0903..
DSSNR2020K12-M	02588173	20	20	125	134,3	25,0	16,9	39,0	45,0	-8,0	0,0	0,5	SN..1204..
DSSNR2525M12-M	02588174	25	25	150	159,3	32,0	23,9	39,0	45,0	-8,0	0,0	0,8	SN..1204..
DSSNR3225P12-M	02588175	32	25	170	179,3	32,0	23,9	39,0	45,0	-8,0	0,0	1,2	SN..1204..
DSSNL2020K12-M	02588176	20	20	125	134,3	25,0	16,9	39,0	45,0	-8,0	0,0	0,5	SN..1204..
DSSNL2525M12-M	02588177	25	25	150	159,3	32,0	23,9	39,0	45,0	-8,0	0,0	0,8	SN..1204..
DSSNL3225P12-M	02588178	32	25	170	179,3	32,0	23,9	39,0	45,0	-8,0	0,0	1,2	SN..1204..
DSSNR2525M15-M	02588179	25	25	150	161,2	32,0	22,0	41,0	45,0	-8,0	0,0	0,9	SN..1506..
DSSNR3232P15-M	02588181	32	32	171	181,2	40,0	29,6	42,0	45,0	-8,0	0,0	1,5	SN..1506..
DSSNL2525M15-M	02588182	25	25	150	161,2	32,0	22,0	41,0	45,0	-8,0	0,0	0,9	SN..1506..
DSSNL3232P15-M	02588184	32	32	171	181,2	40,0	29,6	42,0	45,0	-8,0	0,0	1,5	SN..1506..
DSSNR3232P19-M	02588185	32	32	171	181,2	40,0	30,0	46,0	45,0	-8,0	0,0	1,5	SN..1906..
DSSNR4040R19-M	02588186	40	40	201	213,5	50,0	31,7	46,0	45,0	-8,0	0,0	2,6	SN..1906..
DSSNL3232P19-M	02588187	32	32	171	181,2	40,0	30,0	46,0	45,0	-8,0	0,0	1,5	SN..1906..
DSSNL4040R19-M	02588188	40	40	201	213,5	50,0	31,7	46,0	45,0	-8,0	0,0	2,6	SN..1906..





Spare Parts

For size	Clamp pin	Clamp screw	Floating wedge clamp	Insert shim	Shim/clamp key	Shim screw	Spring
...09	FP1508	L84017-T09P	CD09-S	DSN090310	T09P-2	C03007-T09P	S5608
...12	FP2012	L85021-T15P	CD12-S	DSN120616	T15P-7	C04008-T15P	S6912
...15	FP2012	L86026-T20P	CD16-S	DSN150624	T20P-7L	C05010-T20P	S7010
...19	FP2012	L86026-T20P	CD19-S	DSN190624	T20P-7L	C05010-T20P	S7010

General ISO Turning Holders
Steadyline®
MDT
Mini-Shaft™
Grooving
Parting-off
X4
Adapters Clamping units
Accessories and Spare parts
Workpiece materials

General ISO Turning
Holders

Accessories

For size	Clamp kit	Insert clamping torque	Replacement blade	Torque key
...09	 CD09-S09	 2.0NM	 T00-09P	 T00-09P20
...12	CD12-S12	3.5NM	T00-15P	T00-15P35
...15	CD16-S16	6.0NM	T00T-20P	T00T-20P60
...19	CD19-S19	6.0NM	T00T-20P	T00T-20P60

Steadyline®

MDT

Mini-Shaft™

Grooving

Parting-off

X4

Adapters
Clamping units

Accessories and
Spare parts

Workpiece
materials

DSSNR/L – Toolholders for inserts SNGA, SNGN, SNMA, SNMG, SNMM, SNMN and SNMP – Inch

DSSNR/L
KAPR = 45,0°

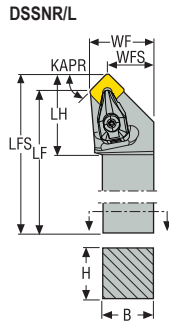
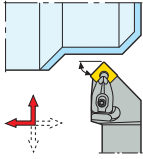

CTWS



- For inserts program, see page(s) 550, 551, 552, 553, 585, 586
- GAMO° = Rake angle, LAMS° = Inclination angle
- CTWS = Insert shape and size
- For holder code key, see page(s) 17-18
- Shim DSN434 for insert SN..44., to be ordered separately
- Right-hand version shown
- Please check availability at www.secotools.com / Seco Online Store

Designation	Item number	H	B	LF	LFS	WF	WFS	LH	KAPR°	GAMO°	LAMS°	Weight	CTWS
		Inch	Inch	Inch	Inch	Inch	Inch	Inch				lbs	
DSSNR-16-4D	02565549	1.000	1.000	5.996	5.669	0.750	1.078	1.575	45,0	-6,0	-6,0	1.760	SN..43.

Spare Parts

For size	Clamp pin	Clamp screw	Floating wedge clamp	Insert shim	Shim/clamp key	Shim screw	Spring
..-4	FP2012	L85021-T15P	CD12-S	DSN444	T15P-7	C04008-T15P	S6912

Accessories

For size	Clamp kit	Insert clamping torque	Replacement blade	Torque key
..-4	CD12-S12	31.0IN.LBS	T00-15P	T00-15P35

DTFNR/L..-M – Toolholders for inserts TNGA, TNMA, TNMG and TNMM – Metric

General ISO Turning
Holders

Steadyline®

MDT

Mini-Shaft™

Grooving

Parting-off

X4

Adapters
Clamping units

Accessories and
Spare parts

Workpiece
materials

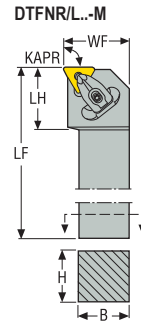

DTFNR/L..-M
KAPR = 90,0 °

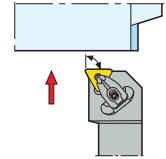

CTWS



- For inserts program, see page(s) 558, 559, 560, 561, 590
- GAMO° = Rake angle, LAMS° = Inclination angle
- CTWS = Insert shape and size
- For holder code key, see page(s) 15-16
- Shim DTN220640 for insert TN..220432..., to be ordered separately
- Right-hand version shown
- Please check availability at www.secotools.com / Seco Online Store

Designation	Item number	H	B	LF	WF	LH	KAPR°	GAMO°	LAMS°	Weight	CTWS
		mm	mm	mm	mm	mm				kg	
DTFNR2020K16-M	02588210	25	25	152	31,75	30,0	90,0	-6,0	-6,0	0,4	TN..1604..
DTFNR2525M16-M	02588211	20	20	125	25,4	29,0	90,0	-6,0	-6,0	0,8	TN..1604..
DTFNR3225P16-M	02588212	20	20	125	25,4	29,0	90,0	-6,0	-6,0	1,1	TN..1604..
DTFNL2020K16-M	02588213	20	20	125	25,0	30,0	90,0	-6,0	-6,0	0,4	TN..1604..
DTFNL2525M16-M	02588214	20	20	125	25,4	29,0	90,0	-6,0	-6,0	0,8	TN..1604..
DTFNL3225P16-M	02588215	20	20	125	25,4	29,0	90,0	-6,0	-6,0	1,1	TN..1604..
DTFNR2525M22-M	02588216	25	25	150	32,0	30,0	90,0	-6,0	-6,0	0,8	TN..2204..
DTFNR3232P22-M	02588218	32	32	170	40,0	32,0	90,0	-6,0	-6,0	1,4	TN..2204..
DTFNL2525M22-M	02588219	25	25	150	32,0	30,0	90,0	-6,0	-6,0	0,8	TN..2204..
DTFNL3232P22-M	02588221	32	32	170	40,0	32,0	90,0	-6,0	-6,0	1,4	TN..2204..

Spare Parts

For size	Clamp pin	Clamp screw	Floating wedge clamp	Insert shim	Shim/clamp key	Shim screw	Spring
...16	FP1508	L84017-T09P	CD09-S	DTN160616	T09P-2	C03007-T09P	S5608
...22	FP2012	L85021-T15P	CD12-S	DTN220616	T15P-7	C04008-T15P	S6912

Accessories

For size	Clamp kit	Insert clamping torque	Replacement blade	Torque key
...16	CD09-S09	2.0NM	T00-09P	T00-09P20
...22	CD12-S12	3.5NM	T00-15P	T00-15P35

DTFNR/L – Toolholders for inserts TNGA, TNMA, TNMG, TNMM and TNMP – Inch

DTFNR/L
KAPR = 90,0°

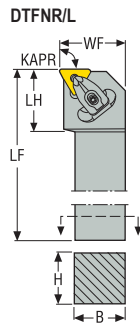
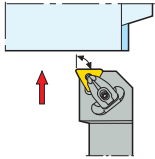

- For inserts program, see page(s) 558, 559, 560, 561, 590
- GAMO° = Rake angle, LAMS° = Inclination angle
- CTWS = Insert shape and size
- For holder code key, see page(s) 17-18
- Shim DTN220640 for insert TN..220432..., to be ordered separately
- Right-hand version shown
- Please check availability at www.secotools.com / Seco Online Store

Designation	Item number	H	B	LF	WF	LH	KAPR°	GAMO°	LAMS°	Weight	CTWS
		Inch	Inch	Inch	Inch	Inch				lbs	
DTFNR-16-3D	02880414	0.787	0.787	4.921	1.000	1.142	90,0	-6,0	-6,0	1.760	TN..33.
DTFNL-16-3D	02880413	0.996	0.996	6.000	1.250	1.181	90,0	-6,0	-6,0	1.760	TN..33.
DTFNR-16-4D	02565878	1.000	1.000	6.000	1.250	1.378	90,0	-6,0	-6,0	1.760	TN..43.
DTFNL-16-4D	02565880	1.000	1.000	6.000	1.250	1.378	90,0	-6,0	-6,0	1.760	TN..43.
DTFNL-20-4D	02565882	1.250	1.250	6.000	1.500	1.378	90,0	-6,0	-6,0	2.650	TN..43.

Spare Parts

For size	Clamp pin	Clamp screw	Floating wedge clamp	Insert shim	Shim/clamp key	Shim screw	Spring
..-3	FP1508	L84017-T09P	CD09-S	DTN344	T09P-2	C03007-T09P	S5608
..-4	FP2012	L85021-T15P	CD12-S	DTN444	T15P-7	C04008-T15P	S6912

Accessories

For size	Clamp kit	Insert clamping torque	Replacement blade	Torque key
..-3	CD09-S09	17.7IN.LBS	T00-09P	T00-09P20
..-4	CD12-S12	31.0IN.LBS	T00-15P	T00-15P35

General ISO Turning
Holders

Steadyline®

MDT

Mini-Shaft™

Grooving

Parting-off

X4

Adapters
Clamping units

Accessories and
Spare parts

Workpiece
materials

DTGNR/L..-M – Toolholders for inserts TNGA, TNMA, TNMG and TNMM – Metric

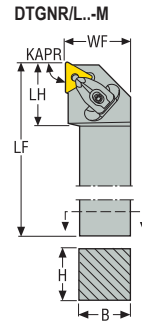

DTGNR/L..-M
KAPR = 90,0 °

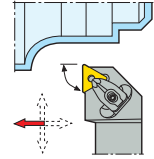

CTWS



- For inserts program, see page(s) 558, 559, 560, 561, 590
- GAMO° = Rake angle, LAMS° = Inclination angle
- CTWS = Insert shape and size
- For holder code key, see page(s) 15-16
- Shim DTN220640 for insert TN..220432..., to be ordered separately
- Right-hand version shown
- Please check availability at www.secotools.com / Seco Online Store

Designation	Item number	H	B	LF	WF	LH	KAPR°	GAMO°	LAMS°	Weight	CTWS
		mm	mm	mm	mm	mm				kg	
DTGNR2020K16-M	02588200	20	20	125	25,0	29,0	90,0	-6,0	-6,0	0,5	TN..1604..
DTGNR2525M16-M	02588201	25	25	150	32,0	30,0	90,0	-6,0	-6,0	0,8	TN..1604..
DTGNL2020K16-M	02588202	20	20	125	25,0	29,0	90,0	-6,0	-6,0	0,5	TN..1604..
DTGNL2525M16-M	02588203	25	25	150	32,0	30,0	90,0	-6,0	-6,0	0,8	TN..1604..
DTGNR2525M22-M	02588204	25	25	150	32,0	31,0	90,0	-6,0	-6,0	0,8	TN..2204..
DTGNR3232P22-M	02588206	32	32	170	40,0	32,0	90,0	-6,0	-6,0	1,4	TN..2204..
DTGNL2525M22-M	02588207	25	25	150	32,0	31,0	90,0	-6,0	-6,0	0,8	TN..2204..
DTGNL3232P22-M	02588209	32	32	170	40,0	32,0	90,0	-6,0	-6,0	1,4	TN..2204..

Spare Parts

For size	Clamp pin	Clamp screw	Floating wedge clamp	Insert shim	Shim/clamp key	Shim screw	Spring
...16	FP1508	L84017-T09P	CD09-S	DTN160616	T09P-2	C03007-T09P	S5608
...22	FP2012	L85021-T15P	CD12-S	DTN220616	T15P-7	C04008-T15P	S6912

Accessories

For size	Clamp kit	Insert clamping torque	Replacement blade	Torque key
...16	CD09-S09	2.0NM	T00-09P	T00-09P20
...22	CD12-S12	3.5NM	T00-15P	T00-15P35

DTGNR/L – Toolholders for inserts TNGA, TNMA, TNMG, TNMM and TNMP – Inch

DTGNR/L
KAPR = 90,0°

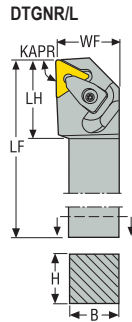
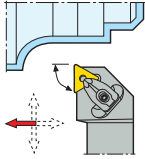

- For inserts program, see page(s) 558, 559, 560, 561, 590
- GAMO° = Rake angle, LAMS° = Inclination angle
- CTWS = Insert shape and size
- For holder code key, see page(s) 17-18
- Shim DTN220640 for insert TN..220432..., to be ordered separately
- Right-hand version shown
- Please check availability at www.secotools.com / Seco Online Store

Designation	Item number	H	B	LF	WF	LH	KAPR°	GAMO°	LAMS°	Weight	CTWS
		Inch	Inch	Inch	Inch	Inch				lbs	
DTGNR-12-3B	02565562	0.750	0.750	4.500	1.000	1.181	90,0	-6,0	-6,0	0.880	TN..33.
DTGNL-12-3B	02565564	0.750	0.750	4.500	1.000	1.181	90,0	-6,0	-6,0	0.880	TN..33.
DTGNR-16-4D	02565566	1.000	1.000	6.000	1.250	1.378	90,0	-6,0	-6,0	1.980	TN..43.
DTGNR-20-4D	02565567	1.250	1.250	6.000	1.500	1.378	90,0	-6,0	-6,0	2.870	TN..43.
DTGNL-16-4D	02565568	1.000	1.000	6.000	1.250	1.378	90,0	-5,0	-6,0	1.980	TN..43.

Spare Parts

For size	Clamp pin	Clamp screw	Floating wedge clamp	Insert shim	Shim/clamp key	Shim screw	Spring
..-3	FP1508	L84017-T09P	CD09-S	DTN344	T09P-2	C03007-T09P	S5608
..-4	FP2012	L85021-T15P	CD12-S	DTN444	T15P-7	C04008-T15P	S6912

Accessories

For size	Clamp kit	Insert clamping torque	Replacement blade	Torque key
..-3	CD09-S09	17.7IN.LBS	T00-09P	T00-09P20
..-4	CD12-S12	31.0IN.LBS	T00-15P	T00-15P35

General ISO Turning
Holders

Steadyline®

MDT

Mini-Shaft™

Grooving

Parting-off

X4

Adapters
Clamping units

Accessories and
Spare parts

Workpiece
materials

DTJNR/L – Toolholders for inserts TNGA, TNMA, TNMG, TNMM, TNMP and TNMX – Inch

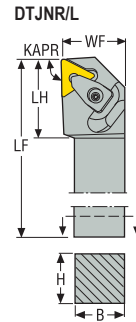

DTJNR/L
KAPR = 93,0 °

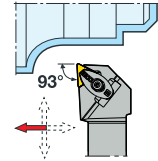

CTWS



- For inserts program, see page(s) 558, 559, 560, 561, 590, 593
- GAMO° = Rake angle, LAMS° = Inclination angle
- CTWS = Insert shape and size
- For holder code key, see page(s) 17-18
- Shim DTN220640 for insert TN..220432..., to be ordered separately
- Right-hand version shown
- Please check availability at www.secotools.com / Seco Online Store

Designation	Item number	H	B	LF	WF	LH	KAPR°	GAMO°	LAMS°	Weight	CTWS
		Inch	Inch	Inch	Inch	Inch				lbs	
DTJNR-12-3B	02565574	0.750	0.750	4.500	1.000	1.181	93,0	-6,0	-6,0	0.880	TN..33.
DTJNR-16-3D	02565575	1.000	1.000	6.000	1.250	1.181	93,0	-6,0	-6,0	1.980	TN..33.
DTJNL-12-3B	02565576	0.750	0.750	4.500	1.000	1.181	93,0	-6,0	-6,0	0.880	TN..33.
DTJNL-16-3D	02565577	1.000	1.000	6.000	1.250	1.181	93,0	-6,0	-6,0	1.980	TN..33.
DTJNR-16-4D	02565578	1.000	1.000	6.000	1.250	1.378	93,0	-6,0	-6,0	1.980	TN..43.
DTJNR-20-4D	02565579	1.250	1.250	6.000	1.500	1.378	93,0	-6,0	-6,0	2.870	TN..43.
DTJNL-16-4D	02565580	1.000	1.000	6.000	1.250	1.378	93,0	-6,0	-6,0	1.980	TN..43.
DTJNL-20-4D	02565581	1.250	1.250	6.000	1.500	1.378	93,0	-6,0	-6,0	2.870	TN..43.

Spare Parts

For size	Clamp pin	Clamp screw	Floating wedge clamp	Insert shim	Shim/clamp key	Shim screw	Spring
...3	-	-	-	DTN344	T09P-2	C03007-T09P	-
...4	FP2012	L85021-T15P	CD12-S	DTN444	T15P-7	C04008-T15P	S6912

Accessories

For size	Clamp kit	Insert clamping torque	Replacement blade	Torque key
...3	CD09-S09	-	-	-
...4	CD12-S12	31.0IN.LBS	T00-15P	T00-15P35

DVJNR/L – Toolholders for inserts VNGA, VNGG, VNGM, VNMA, VNMG and VNMU – Metric

DVJNR/L
KAPR = 93,0°

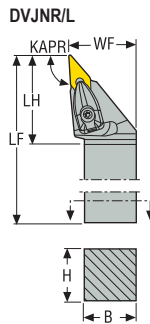
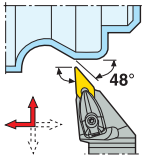

CTWS



- For inserts program, see page(s) 565, 566, 595
- GAMO° = Rake angle, LAMS° = Inclination angle
- CTWS = Insert shape and size
- For holder code key, see page(s) 15-16
- Right-hand version shown
- Please check availability at www.secotools.com / Seco Online Store

Designation	Item number	H	B	LF	WF	LH	KAPR°	GAMO°	LAMS°	Weight	CTWS
		mm	mm	mm	mm	mm				kg	
DVJNR1616H13	02588228	16	16	100	20,0	42,0	93,0	-4,5	-13,5	0,2	VN..1304..
DVJNR2020K13	02564430	20	20	125	25,0	42,0	93,0	-4,5	-13,5	0,4	VN..1304..
DVJNR2525M13	02528621	25	25	150	32,0	42,0	93,0	-4,5	-13,5	0,7	VN..1304..
DVJNL1616H13	02588229	16	16	100	20,2	42,0	93,0	-4,5	-13,5	0,2	VN..1304..
DVJNL2020K13	02588230	20	20	125	25,0	42,0	93,0	-4,5	-13,5	0,4	VN..1304..
DVJNL2525M13	02588231	25	25	150	32,0	42,0	93,0	-4,5	-13,5	0,7	VN..1304..
DVJNR2020K16	02588232	20	20	125	25,0	41,0	93,0	-4,5	-13,5	0,4	VN..1604..
DVJNR2525M16	02588233	25	25	150	32,0	41,0	93,0	-4,5	-13,5	0,7	VN..1604..
DVJNR3225P16	02588234	32	25	170	32,0	41,0	93,0	-4,5	-13,5	1,0	VN..1604..
DVJNL2020K16	02588235	20	20	125	25,0	41,0	93,0	-4,5	-13,5	0,4	VN..1604..
DVJNL2525M16	02588236	25	25	150	32,0	41,0	93,0	-4,5	-13,5	0,7	VN..1604..
DVJNL3225P16	02576463	32	25	170	32,0	41,0	93,0	-4,5	-13,5	1,0	VN..1604..

Spare Parts

For size	Clamp pin	Clamp screw	Floating wedge clamp	Insert shim	Shim/clamp key	Shim screw	Spring
...13	FP1508	L84017-T09P	CD08-S	PVN130308	T09P-2	CS5008-T09P	S5608
...16	FP2012	L85021-T15P	CD19-S-V16	DVN160310	T15P-7	C03508-T15P	S6912

Accessories

For size	Clamp kit	Insert clamping torque	Replacement blade	Torque key
...13	CD08-V13	2.0NM	T00-09P	T00-09P20
...16	CD19-V16	3.5NM	T00-15P	T00-15P35

DVJNR/L – Toolholders for inserts VNGA, VNGM, VNGP, VNMA, VNMG, VNMP and VNMU – Inch

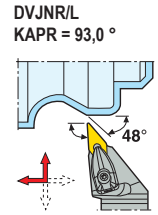
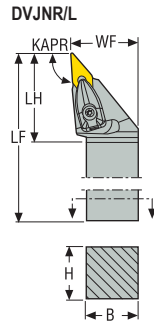

CTWS



- For inserts program, see page(s) 565, 566, 595
- GAMO° = Rake angle, LAMS° = Inclination angle
- CTWS = Insert shape and size
- For holder code key, see page(s) 17-18
- Right-hand version shown
- Please check availability at www.secotools.com / Seco Online Store

Designation	Item number	H	B	LF	WF	LH	KAPR°	GAMO°	LAMS°	Weight	CTWS
		Inch	Inch	Inch	Inch	Inch				lbs	
DVJNR-12-3B	02822861	0.750	0.750	4.500	1.000	1.772	93,0	-4,5	-13,5	0.880	VN..33.
DVJNR-16-3C	02822863	1.000	1.000	5.000	1.250	1.772	93,0	-4,5	-13,5	1.320	VN..33.
DVJNR-20-3D	02822866	0.750	0.750	4.500	1.000	1.772	93,0	-4,5	-13,5	2.650	VN..33.
DVJNL-12-3B	02822862	0.750	0.750	4.500	1.000	1.772	93,0	-4,5	-13,5	0.880	VN..33.
DVJNL-16-3C	02822864	1.000	1.000	5.000	1.250	1.772	93,0	-4,5	-13,5	1.320	VN..33.
DVJNL-20-3D	02822867	1.250	1.250	6.000	1.500	1.654	93,0	-4,5	-13,5	2.650	VN..33.

Spare Parts

For size	Clamp pin	Clamp screw	Floating wedge clamp	Insert shim	Shim/clamp key	Shim screw	Spring
...3	FP2012	L85021-T15P	CD19-S-V16	DVN322.5	T15P-7	C03508-T15P	S6912

Accessories

For size	Clamp kit	Insert clamping torque	Replacement blade	Torque key
...3	CD19-V16	31.0IN.LBS	T00-15P	T00-15P35

General ISO Turning Holders
Steadyline®
MDT
Mini-Shaft™
Grooving
Parting-off
X4
Adapters Clamping units
Accessories and Spare parts
Workpiece materials

DVPNR/L – Toolholders for inserts VNGA, VNGG, VNGM, VNMA and VNMG – Metric

DVPNR/L
KAPR = 117,5 °

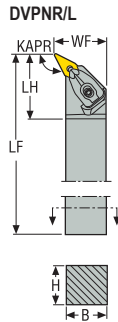
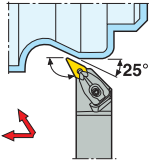







CTWS







- For inserts program, see page(s) 565, 566, 595
- GAMO° = Rake angle, LAMS° = Inclination angle
- CTWS = Insert shape and size
- For holder code key, see page(s) 15-16
- Right-hand version shown
- Please check availability at www.secotools.com / Seco Online Store

Designation	Item number	H	B	LF	WF	LH	KAPR°	GAMO°	LAMS°	Weight	CTWS
		mm	mm	mm	mm	mm				kg	
DVPNR2020K16	02588222	20	20	125	25,0	42,0	117,5	-4,5	-13,5	0,5	VN..1604..
DVPNR2525M16	02588223	25	25	150	32,0	41,0	117,5	-4,5	-13,5	0,8	VN..1604..
DVPNR3232P16	02588224	32	32	170	40,0	41,0	117,5	-4,5	-13,5	1,4	VN..1604..
DVPNL2020K16	02588225	20	20	125	25,0	42,0	117,5	-4,5	-13,5	0,5	VN..1604..
DVPNL2525M16	02588226	25	25	150	32,0	41,0	117,5	-4,5	-13,5	0,8	VN..1604..
DVPNL3232P16	02588227	32	32	170	40,0	41,0	117,5	-4,5	-13,5	1,4	VN..1604..

Spare Parts

For size	Clamp pin	Clamp screw	Floating wedge clamp	Insert shim	Shim/clamp key	Shim screw	Spring
...16	 FP2012	 L85021-T15P	 CD19-S-V16	 DVN160310	 T15P-7	 C03508-T15P	 S6912

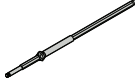
Accessories

For size	Clamp kit	Insert clamping torque	Replacement blade	Torque key
...16	 CD19-V16	 3.5NM	 T00-15P	 T00-15P35

General ISO Turning
Holders

Steadyline®

MDT

Mini-Shaft™

Grooving

Parting-off

X4

Adapters
Clamping units

Accessories and
Spare parts

Workpiece
materials

DVPCR/L – Toolholders for inserts VNGA, VNGM, VNGP, VNMA, VNMG, VNMP and VNMU – Inch

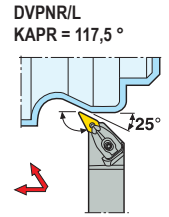
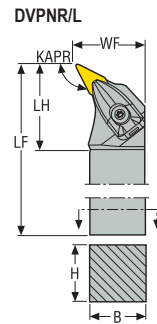

CTWS



- For inserts program, see page(s) 565, 566, 595
- GAMO° = Rake angle, LAMS° = Inclination angle
- CTWS = Insert shape and size
- For holder code key, see page(s) 17-18
- Right-hand version shown
- Please check availability at www.secotools.com / Seco Online Store

Designation	Item number	H	B	LF	WF	LH	KAPRI°	GAMO°	LAMS°	Weight	CTWS
		Inch	Inch	Inch	Inch	Inch				lbs	
DVPCR-16-3D	02880417	0.996	0.996	6.000	1.250	1.772	117,5	-4,0	-12,5	1.760	VN..33.
DVPCR-16-3D	02880415	0.996	0.996	6.000	1.250	1.772	117,5	-4,0	-12,5	1.760	VN..33.

Spare Parts

For size	Clamp pin	Clamp screw	Floating wedge clamp	Insert shim	Shim/clamp key	Shim screw	Spring
...3	FP2012	L85021-T15P	CD19-S-V16	DVN322.5	T15P-7	C03508-T15P	S6912

Accessories

For size	Clamp kit	Insert clamping torque	Replacement blade	Torque key
...3	CD19-V16	31.0IN.LBS	T00-15P	T00-15P35

General ISO Turning Holders
Steadyline®
MDT
Mini-Shaft™
Grooving
Parting-off
X4
Adapters Clamping units
Accessories and Spare parts
Workpiece materials

DWLNRL – Toolholders for inserts WNGA, WNGG, WNMA, WNMG and WNMM – Metric

DWLNRL
KAPR = 95,0°

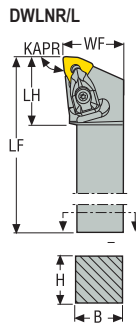
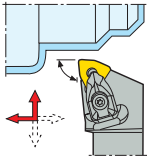

- For inserts program, see page(s) 568, 569, 570, 571, 596
- GAMO° = Rake angle, LAMS° = Inclination angle
- CTWS = Insert shape and size
- For holder code key, see page(s) 15-16
- Right-hand version shown
- * Use the right shim & the right screw for the selected insert. For details, see page 99
- Please check availability at www.secotools.com / Seco Online Store

Designation	Item number	H	B	LF	WF	LH	KAPR°	GAMO°	LAMS°	Weight	CTWS
		mm	mm	mm	mm	mm				kg	
DWLNRL1616H06	02588237	16	16	100	20,0	31,0	95,0	-6,0	-6,0	0,3	WN..0604..
DWLNRL2020K06	00038364	20	20	125	25,0	31,0	95,0	-6,0	-6,0	0,4	WN..0604..
DWLNRL2525M06	00038365	25	25	150	32,0	30,0	95,0	-6,0	-6,0	0,8	WN..0604..
DWLNRL3232P06	02588238	32	32	170	40,0	32,0	95,0	-6,0	-6,0	1,4	WN..0604..
DWLNRL1616H08	02588239	16	16	100	20,0	31,0	95,0	-6,0	-6,0	0,3	WN..0604..
DWLNRL2020K08	00038361	20	20	125	25,0	31,0	95,0	-6,0	-6,0	0,4	WN..0604..
DWLNRL2525M08	00038362	25	25	150	32,0	30,0	95,0	-6,0	-6,0	0,8	WN..0604..
DWLNRL3232P08	02588240	32	32	170	40,0	32,0	95,0	-6,0	-6,0	1,4	WN..0604..
DWLNRL2020K08	02588241	20	20	125	25,0	31,0	95,0	-6,0	-6,0	0,4	WN..0804/WN..0806*
DWLNRL2525M08	00038372	25	25	150	32,0	35,0	95,0	-6,0	-6,0	0,8	WN..0804/WN..0806*
DWLNRL3232P08	00038374	32	32	170	40,0	35,0	95,0	-6,0	-6,0	1,4	WN..0804/WN..0806*
DWLNRL2020K08	02588242	20	20	125	25,0	31,0	95,0	-6,0	-6,0	0,4	WN..0804/WN..0806*
DWLNRL2525M08	00038368	25	25	150	32,0	35,0	95,0	-6,0	-6,0	0,8	WN..0804/WN..0806*
DWLNRL3232P08	00038370	32	32	170	40,0	35,0	95,0	-6,0	-6,0	1,4	WN..0804/WN..0806*

Spare Parts

For size	Clamp pin	Clamp screw	Floating wedge clamp	Insert shim	Shim/clamp key	Shim screw	Spring
...06	FP1508	L84017-T09P	CD09-S	DWN060310	T09P-2	C03007-T09P	S5608
...08	FP2012	L85021-T15P	CD12-S	DWN080416	T15P-7	C04008-T15P	S6912

Accessories

For size	Clamp kit	Insert clamping torque	Replacement blade	Torque key
...06	CD09-S09	2.0NM	T00-09P	T00-09P20
...08	CD12-S12	3.5NM	T00-15P	T00-15P35

General ISO Turning
Holders

Steadyline®

MDT

Mini-Shaft™

Grooving

Parting-off

X4

Adapters
Clamping units

Accessories and
Spare parts

Workpiece
materials

DWLNR/L – Toolholders for inserts WNGA, WNGP, WNMA, WNMG, WNMM and WNMP – Inch

General ISO Turning
Holders

Steadyline®

MDT

Mini-Shaft™

Grooving

Parting-off

X4

Adapters
Clamping units

Accessories and
Spare parts

Workpiece
materials

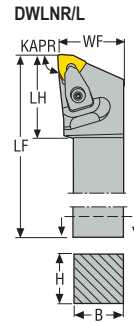

DWLNR/L
KAPR = 95,0 °

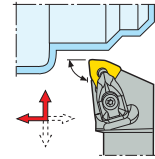

CTWS



- For inserts program, see page(s) 568, 569, 570, 571, 596
- GAMO° = Rake angle, LAMS° = Inclination angle
- CTWS = Insert shape and size
- For holder code key, see page(s) 17-18
- Right-hand version shown
- * Use the right shim & the right screw for the selected insert. For details, see page 99
- Please check availability at www.secotools.com / Seco Online Store

Designation	Item number	H	B	LF	WF	LH	KAPR°	GAMO°	LAMS°	Weight	CTWS
		Inch	Inch	Inch	Inch	Inch				lbs	
DWLNR-10-3B	02880420	0.625	0.625	4.500	0.875	1.181	95,0	-6,0	-6,0	0.660	WN..33.
DWLNR-12-3B	02565594	0.750	0.750	4.500	1.000	1.260	95,0	-6,0	-6,0	0.880	WN..33.
DWLNR-16-3D	02565596	1.000	1.000	6.000	1.250	1.260	95,0	-6,0	-6,0	1.980	WN..33.
DWLNL-10-3B	02880419	0.625	0.625	4.500	0.875	1.181	95,0	-6,0	-6,0	0.660	WN..33.
DWLNL-12-3B	02565598	0.750	0.750	4.500	1.000	1.260	95,0	-6,0	-6,0	0.880	WN..33.
DWLNL-16-3D	02565600	1.000	1.000	6.000	1.250	1.260	95,0	-6,0	-6,0	1.980	WN..33.
DWLNR-12-4B	02565602	0.750	0.750	4.500	1.000	1.378	95,0	-6,0	-6,0	0.880	WN..43/WN..44*
DWLNR-16-4D	02569286	1.000	1.000	6.000	1.250	1.378	95,0	-6,0	-6,0	1.980	WN..43/WN..44*
DWLNR-16-4D-C	02605007	1.000	1.000	6.000	1.250	1.378	95,0	-6,0	-6,0	1.760	WN..43/WN..44*
DWLNR-20-4D	02565605	1.250	1.250	6.000	1.500	1.378	95,0	-6,0	-6,0	2.870	WN..43/WN..44*
DWLNL-12-4B	02565606	0.750	0.750	4.500	1.000	1.378	95,0	-6,0	-6,0	0.880	WN..43/WN..44*
DWLNL-16-4D	02569287	1.000	1.000	6.000	1.250	1.378	95,0	-6,0	-6,0	1.760	WN..43/WN..44*
DWLNL-16-4D-C	02605010	1.000	1.000	6.000	1.250	1.378	95,0	-6,0	-6,0	1.760	WN..43/WN..44*
DWLNL-20-4D	02565609	1.250	1.250	6.000	1.500	1.378	95,0	-6,0	-6,0	2.870	WN..43/WN..44*

Spare Parts

For size	Clamp pin	Clamp screw	Floating wedge clamp	Insert shim	Shim/clamp key	Shim screw	Spring
...-3	FP1508	L84017-T09P	CD09-S	DWN322.5	T09P-2	C03007-T09P	S5608
...-4	FP2012	L85021-T15P	CD12-S	DWN434	T15P-7	C04008-T15P	S6912

Accessories

For size	Clamp kit	Insert clamping torque	Replacement blade	Torque key
...-3	CD09-S09	17.7IN.LBS	T00-09P	T00-09P20
...-4	CD12-S12	31.0IN.LBS	T00-15P	T00-15P35

PCBNR/L – Toolholders for inserts CNGA, CNGG, CNMA, CNMG and CNMM – Metric

PCBNR/L
KAPR = 75,0°

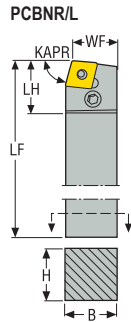
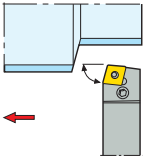

- For inserts program, see page(s) 527, 528, 529, 530, 531, 532, 533, 575, 576
- GAMO° = Rake angle, LAMS° = Inclination angle
- CTWS = Insert shape and size
- For holder code key, see page(s) 15-16
- Right-hand version shown
- Please check availability at www.secotools.com / Seco Online Store

Designation	Item number	H	B	LF	WF	LH	KAPR°	GAMO°	LAMS°	Weight	CTWS
		mm	mm	mm	mm	mm				kg	
PCBNR2525M12	00038382	25	25	150	22,0	26,0	75,0	-6,0	-6,0	0,7	CN..1204..
PCBNL2525M12	00038383	25	25	150	22,0	26,0	75,0	-6,0	-6,0	0,7	CN..1204..
PCBNR3232P19	02583736	32	32	170	27,0	37,0	75,0	-6,0	-6,0	1,3	CN..1906..
PCBNR4040S19	02803939	40	40	250	35,0	38,0	75,0	-6,0	-6,0	3,1	CN..1906..
PCBNL3232P19	00734298	32	32	170	27,0	37,0	75,0	-6,0	-6,0	1,3	CN..1906..
PCBNL4040S19	02803940	40	40	250	35,0	38,0	75,0	-6,0	-6,0	3,0	CN..1906..

Spare Parts

For size	Insert lever	Insert shim	Lever key	Lever screw	Punch	Shim pin
...12	PP4713	PCN120308	3SMS795	LS0818	MP0912	RP6757
...19	PP7521	PCN190416	4SMS795	LS1027	MP1519	RP9811

Accessories

For size	Insert clamping torque	Replacement blade	Torque key
...12	-	-	-
...19	5.0NM	H00T-4.0	H00T-4050

General ISO Turning
Holders

Steadyline®

MDT

Mini-Shaft™

Grooving

Parting-off

X4

Adapters
Clamping units

Accessories and
Spare parts

Workpiece
materials

PCLNR/L – Toolholders for inserts CNGA, CNGG, CNMA, CNMG and CNMM – Metric

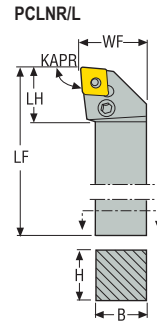

PCLNR/L
KAPR = 95,0 °

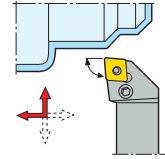

CTWS





- For inserts program, see page(s) 527, 528, 529, 530, 531, 532, 533, 575, 576
- GAMO° = Rake angle, LAMS° = Inclination angle
- CTWS = Insert shape and size
- For holder code key, see page(s) 15-16
- Right-hand version shown
- Please check availability at www.secotools.com / Seco Online Store

Designation	Item number	H	B	LF	WF	LH	KAPR°	GAMO°	LAMS°	Weight	CTWS
		mm	mm	mm	mm	mm				kg	
PCLNR2020K12	00038376	20	20	125	25,0	26,0	95,0	-6,0	-6,0	0,4	CN..1204..
PCLNR2525M12	00038377	25	25	150	32,0	26,0	95,0	-6,0	-6,0	0,8	CN..1204..
PCLNR3225P12	00038378	32	25	170	32,0	26,0	95,0	-6,0	-6,0	1,1	CN..1204..
PCLNL2020K12	00038379	20	20	125	25,0	26,0	95,0	-6,0	-6,0	0,4	CN..1204..
PCLNL2525M12	00038380	25	25	150	32,0	26,0	95,0	-6,0	-6,0	0,8	CN..1204..
PCLNL3225P12	00038381	32	25	170	32,0	26,0	95,0	-6,0	-6,0	1,1	CN..1204..
PCLNR2525M16	02903947	25	25	150	32,0	33,0	95,0	-6,0	-6,0	0,8	CN..1606..
PCLNR3232P16	02862002	32	32	170	40,0	33,0	95,0	-6,0	-6,0	1,4	CN..1606..
PCLNL2525M16	02903946	25	25	150	32,0	33,0	95,0	-6,0	-6,0	0,8	CN..1606..
PCLNL3232P16	02871184	32	32	170	40,0	33,0	95,0	-6,0	-6,0	1,4	CN..1606..
PCLNR3232P19	00734301	32	32	170	40,0	37,0	95,0	-6,0	-6,0	0,1	CN..1906..
PCLNR4040S19	02468695	40	40	250	50,0	38,0	95,0	-6,0	-6,0	1,5	CN..1906..
PCLNL3232P19	00734302	32	32	170	40,0	37,0	95,0	-6,0	-6,0	1,4	CN..1906..
PCLNL4040S19	02468696	40	40	250	50,0	38,0	95,0	-6,0	-6,0	3,1	CN..1906..
PCLNR4040S25	02450797	40	40	250	50,2	48,0	95,0	-6,0	-6,0	3,1	CN..2509..
PCLNL4040S25	02766744	40	40	250	50,2	48,0	95,0	-6,0	-6,0	3,1	CN..2509..

Spare Parts

For size	Insert lever	Insert shim	Lever key	Lever screw	Punch	Shim pin
...12	PP4713	PCN120308	3SMS795	LS0818	MP0912	RP6757
...16	PP6017	PCN160412	3SMS795	LS0820	MP1519	RP8286
...19	PP7521	PCN190416	4SMS795	LS1027	MP1519	RP9811
...25	PP1325	PCN250620	5SMS795	LS1236	MP25	RP1312

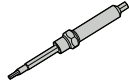
Accessories

For size	Insert clamping torque 	Replacement blade 	Torque key 
...12	-	-	-
...16	-	-	-
...19	5.0NM	H00T-4.0	H00T-4050
...25	5.0NM	H00T-5.0	H00T-5050

General ISO Turning
Holders

Steadyline®

MDT

Mini-Shaft™

Grooving

Parting-off

X4

Adapters
Clamping units

Accessories and
Spare parts

Workpiece
materials

PDJNR/L – Toolholders for inserts DNGA, DNGG, DNGM, DNMA, DNMG, DNMM, DNMU and DNMX – Metric

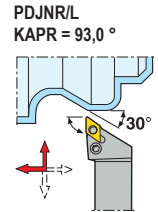
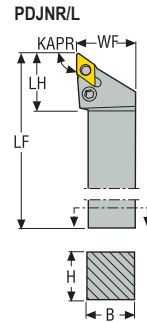

CTWS



- For inserts program, see page(s) 537, 538, 539, 540, 541, 316, 580, 598
- GAMO° = Rake angle, LAMS° = Inclination angle
- CTWS = Insert shape and size
- For holder code key, see page(s) 15-16
- Right-hand version shown
- * Use the right shim & the right screw for the selected insert. For details, see page 99
- Please check availability at www.secotools.com / Seco Online Store

Designation	Item number	H	B	LF	WF	LH	KAPR°	GAMO°	LAMS°	Weight	CTWS
		mm	mm	mm	mm	mm				kg	
PDJNR1616H11	00038384	16	16	100	20,0	24,0	93,0	-6,0	-6,0	0,2	DN..1104..
PDJNR2020K11	00038385	20	20	125	25,0	30,0	93,0	-6,0	-7,0	0,5	DN..1104..
PDJNR2525M11	00038386	25	25	150	32,0	30,0	93,0	-6,0	-7,0	0,7	DN..1104..
PDJNR3225P11	00038387	32	25	170	32,0	30,0	93,0	-6,0	-7,0	1,0	DN..1104..
PDJNL1616H11	00038388	16	16	100	20,0	24,0	93,0	-6,0	-6,0	0,2	DN..1104..
PDJNL2020K11	00038389	20	20	125	25,0	30,0	93,0	-6,0	-7,0	0,5	DN..1104..
PDJNL2525M11	00038390	25	25	150	32,0	30,0	93,0	-6,0	-7,0	0,7	DN..1104..
PDJNL3225P11	00038391	32	25	170	32,0	30,0	93,0	-6,0	-7,0	1,0	DN..1104..
PDJNR2020K15	00038392	20	20	125	25,0	36,0	93,0	-6,0	-7,0	0,4	DN.1504/DN..1506*
PDJNR2525M15	00038393	25	25	150	32,0	36,0	93,0	-6,0	-7,0	0,7	DN.1504/DN..1506*
PDJNR3225P15	00038394	32	25	170	32,0	36,0	93,0	-6,0	-7,0	1,1	DN.1504/DN..1506*
PDJNL2020K15	00038395	20	20	125	25,0	36,0	93,0	-6,0	-7,0	0,4	DN.1504/DN..1506*
PDJNL2525M15	00038396	25	25	150	32,0	36,0	93,0	-6,0	-7,0	0,7	DN.1504/DN..1506*
PDJNL3225P15	00038397	32	25	170	32,0	36,0	93,0	-6,0	-7,0	1,1	DN.1504/DN..1506*

Spare Parts

For size	Insert lever	Insert shim	Lever key	Lever screw	Punch	Shim pin
...11	PP3512	PDN110308	2.5SMS795	LS0616	MP0912	RP5153
...15	PP4716	PDN150308	3SMS795	LS0822	MP0912	RP6757

Accessories

For size	Insert clamping torque	Torque key
...11	3.0NM	H00-2530
...15	-	-

PDNNR/L – Toolholders for inserts DNGA, DNGG, DNGM, DNMA, DNMG, DNMM and DNMU – Metric

PDNNR/L
KAPR = 63,0°

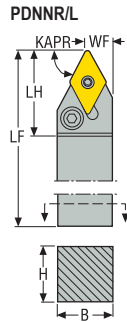
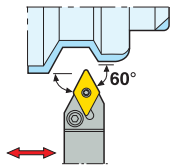

- For inserts program, see page(s) 537, 538, 539, 540, 541, 579, 580, 598
- GAMO° = Rake angle, LAMS° = Inclination angle
- CTWS = Insert shape and size
- For holder code key, see page(s) 15-16
- Right-hand version shown
- * Use the right shim & the right screw for the selected insert. For details, see page 99
- Please check availability at www.secotools.com / Seco Online Store

Designation	Item number	H	B	LF	WF	LH	KAPR°	GAMO°	LAMS°	Weight	CTWS
		mm	mm	mm	mm	mm				kg	
PDNNR1616H11	02411172	16	16	100	8,0	25,0	63,0	-6,0	-6,0	0,2	DN..1104..
PDNNR2020K11	75077811	20	20	125	10,0	25,0	63,0	-6,0	-6,0	0,4	DN..1104..
PDNNR2525M11	75077812	25	25	150	12,5	30,0	63,0	-6,0	-6,0	0,7	DN..1104..
PDNNL1616H11	02411173	16	16	100	8,0	25,0	63,0	-6,0	-6,0	0,2	DN..1104..
PDNNL2020K11	75079685	20	20	125	10,0	25,0	63,0	-6,0	-6,0	0,4	DN..1104..
PDNNL2525M11	75079686	25	25	150	12,5	30,0	63,0	-6,0	-6,0	0,7	DN..1104..
PDNNR2020K15	02411180	20	20	125	10,0	36,0	63,0	-6,0	-6,0	0,4	DN.1504/DN..1506*
PDNNR2525M15	02411182	25	25	150	12,5	36,0	63,0	-6,0	-6,0	0,7	DN.1504/DN..1506*
PDNNR3225P15	02411186	32	25	170	12,5	36,0	63,0	-6,0	-6,0	1,0	DN.1504/DN..1506*
PDNNL2020K15	02411181	20	20	125	10,0	36,0	63,0	-6,0	-6,0	0,4	DN.1504/DN..1506*
PDNNL2525M15	02411185	25	25	150	12,5	36,0	63,0	-6,0	-6,0	0,7	DN.1504/DN..1506*
PDNNL3225P15	02411187	32	25	170	12,5	36,0	63,0	-6,0	-6,0	1,0	DN.1504/DN..1506*

Spare Parts

For size	Insert lever	Insert shim	Lever key	Lever screw	Punch	Shim pin
...11	PP3512	PDN110308	2.5SMS795	LS0616	MP0912	RP5153
...15	PP4716	PDN150308	3SMS795	LS0822	MP0912	RP6757

Accessories

For size	Insert clamping torque	Torque key
...11	3.0NM	H00-2530
...15	-	-

PRDCN – Toolholders for inserts RCMX – Metric

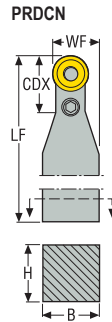

PRDCN
KAPR = 45,0 °

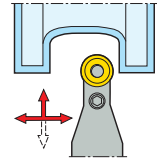

CTWS



- For inserts program, see page(s) 545, 546
- GAMO° = Rake angle, LAMS° = Inclination angle
- CTWS = Insert shape and size
- For holder code key, see page(s) 15-16
- Neutral version shown
- Please check availability at www.secotools.com / Seco Online Store

Designation	Item number	H	B	LF	WF	CDX	KAPR°	GAMO°	LAMS°	Weight	CTWS
		mm	mm	mm	mm	mm				kg	
PRDCN3232P20	02751641	32	32	170	26,0	33,5	45,0	0,0	-8,0	1,2	RCMX200600
PRDCN4040S25	02674471	40	40	250	32,5	45,0	45,0	0,0	-8,0	2,8	RCMX250700
PRDCN5050T32	02616805	50	50	300	40,9	50,0	45,0	0,0	-8,0	5,3	RCMX320900

Spare Parts

For size	Insert lever	Insert shim	Lever key	Lever screw	Punch	Shim pin
...20	PP5620	PRN2004M0	3SMS795	LS0823	MP1519	RP8286
...25	PP6224	PRN2506M0	4SMS795	LS1030	MP1519	RP9811
...32	PP8030	PRN3206M0	5SMS795	LS1236	MP25	RP1312

Accessories

For size	Insert clamping torque	Replacement blade	Torque key
...20	-	-	-
...25	5.0NM	H00T-4.0	H00T-4050
...32	-	-	-

PROON – Toolholders for inserts RCMM – Inch

PROON
KAPR = 90,0°

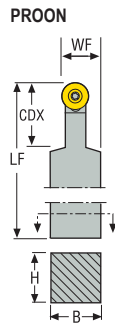
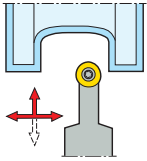

CTWS



- For inserts program, see page(s) 545, 546
- GAMO° = Rake angle, LAMS° = Inclination angle
- CTWS = Insert shape and size
- For holder code key, see page(s) 17-18
- Neutral version shown
- Please check availability at www.secotools.com / Seco Online Store

Designation	Item number	H	B	LF	WF	CDX	KAPR°	GAMO°	LAMS°	Weight	CTWS
		Inch	Inch	Inch	Inch	Inch				lbs	
PROON-20-6	00015025	1.250	1.250	7.000	1.000	2.000	90,0	0,0	0,0	2.650	RCMM64
PROON-20-8	00015030	1.250	1.250	10.000	1.125	2.500	90,0	0,0	0,0	4.190	RCMM84
PROON-85-4	00015040	1.252	1.000	6.000	0.750	1.500	90,0	0,0	0,0	1.980	RCMM43

Spare Parts

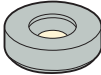
For size	Insert pin	Insert shim
..6	 PL-68	 RS-63P
..8	PL-68	RS-83P
..4	PL-46	RS-43P

General ISO Turning Holders
Steadyline®
MDT
Mini-Shaft™
Grooving
Parting-off
X4
Adapters Clamping units
Accessories and Spare parts
Workpiece materials

PSBNR/L – Toolholders for inserts SNGA, SNMA, SNMG and SNMM – Metric

General ISO Turning
Holders

Steadyline®

MDT

Mini-Shaft™

Grooving

Parting-off

X4

Adapters
Clamping units

Accessories and
Spare parts

Workpiece
materials

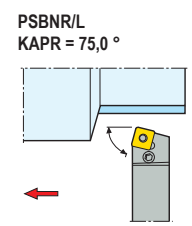
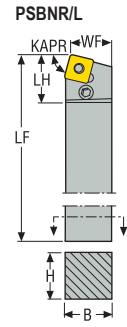

CTWS





- For inserts program, see page(s) 550, 551, 552, 553, 585
- GAMO° = Rake angle, LAMS° = Inclination angle
- CTWS = Insert shape and size
- For holder code key, see page(s) 15-16
- Right-hand version shown
- Please check availability at www.secotools.com / Seco Online Store

Designation	Item number	H	B	LF	WF	LH	KAPR°	GAMO°	LAMS°	Weight	CTWS
		mm	mm	mm	mm	mm				kg	
PSBNR2020K12	00038404	20	20	125	20,3	26,0	75,0	-6,0	-6,0	0,4	SN..1204..
PSBNR2525M12	00038405	25	25	150	25,3	26,0	75,0	-6,0	-6,0	0,8	SN..1204..
PSBNR3225P12	00038406	32	25	170	25,3	26,0	75,0	-6,0	-6,0	1,1	SN..1204..
PSBNL2020K12	00038407	20	20	125	20,3	26,0	75,0	-6,0	-6,0	0,4	SN..1204..
PSBNL2525M12	00038408	25	25	150	25,3	26,0	75,0	-6,0	-6,0	0,8	SN..1204..
PSBNL3225P12	00038409	32	25	170	25,3	26,0	75,0	-6,0	-6,0	1,1	SN..1204..
PSBNR3232P19	02573597	32	32	170	27,0	37,0	75,0	-6,0	-6,0	1,3	SN..1906..
PSBNR4040S19	00045698	40	40	250	35,0	38,0	75,0	-6,0	-6,0	3,0	SN..1906..
PSBNL3232P19	02573603	32	32	170	27,0	37,0	75,0	-6,0	-6,0	1,5	SN..1906..
PSBNL4040S19	00045697	40	40	250	35,0	38,0	75,0	-6,0	-6,0	3,0	SN..1906..
PSBNR4040S25	02573594	40	40	250	35,2	48,0	75,0	-6,0	-6,0	3,1	SN..2507..
PSBNR5050S25	02415304	50	50	250	43,2	48,0	75,0	-6,0	-6,0	4,7	SN..2507..
PSBNL4040S25	02414516	40	40	250	35,2	48,0	75,0	-6,0	-6,0	3,1	SN..2507..
PSBNL5050S25	02415305	50	50	250	43,2	48,0	75,0	-6,0	-6,0	4,7	SN..2507..
PSBNR4040S2509	02785011	40	40	250	35,2	48,0	75,0	-6,0	-6,0	3,0	SN..2509..

Spare Parts

For size	Insert lever	Insert shim	Lever key	Lever screw	Punch	Shim pin
...12	PP4713	PSN120312	3SMS795	LS0818	MP0912	RP6757
...19	PP7521	PSN190412	4SMS795	LS1027	MP1519	RP9811
...25	PP1325	PSN250624	5SMS795	LS1236	MP25	RP1312
...2509	PP1325	PSN250624	5SMS795	LS1236	MP25	RP1312

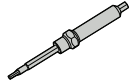
Accessories

For size	Insert clamping torque 	Replacement blade 	Torque key 
...12	-	-	-
...19	5.0NM	H00T-4.0	H00T-4050
...25	5.0NM	H00T-5.0	H00T-5050
...2509	5.0NM	H00T-5.0	H00T-5050

General ISO Turning
Holders

Steadyline®

MDT

Mini-Shaft™

Grooving

Parting-off

X4

Adapters
Clamping units

Accessories and
Spare parts

Workpiece
materials

PSDNN and PSKNR/L – Toolholders for inserts SNGA, SNMA, SNMG and SNMM – Metric

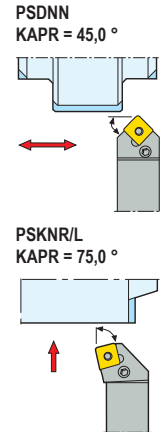
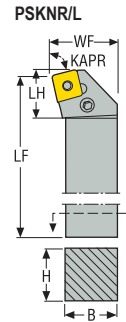
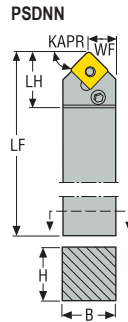

CTWS



- For inserts program, see page(s) 550, 551, 552, 553, 585
- GAMO° = Rake angle, LAMS° = Inclination angle
- CTWS = Insert shape and size
- For holder code key, see page(s) 15-16
- PSDNN = Neutral version shown
- PSKNR/L = Right-hand version shown
- Please check availability at www.secotools.com / Seco Online Store

Designation	Item number	H	B	LF	WF	LH	KAPR°	GAMO°	LAMS°	Weight	CTWS
		mm	mm	mm	mm	mm				kg	
PSDNN2020K12	00038410	20	20	125	10,0	26,0	45,0	-7,0	-7,0	0,4	SN..1204..
PSDNN2525M12	00038411	25	25	150	12,5	26,0	45,0	-7,0	-7,0	0,7	SN..1204..
PSDNN3225P12	00038412	32	25	170	12,5	28,0	45,0	-7,0	-7,0	1,0	SN..1204..
PSDNN3232P19	00469420	32	32	170	16,0	40,0	45,0	-6,0	-6,0	1,3	SN..1906..
PSDNN4040S25	02414517	40	40	250	20,2	48,0	45,0	-6,0	-6,0	3,0	SN..2507..
PSKNR2020K12	00038413	20	20	125	25,0	23,0	75,0	-6,0	-6,0	0,4	SN..1204..
PSKNR2525M12	00038414	25	25	150	32,0	23,0	75,0	-6,0	-6,0	0,8	SN..1204..
PSKNL2020K12	00038416	20	20	125	25,0	23,0	75,0	-6,0	-6,0	0,4	SN..1204..
PSKNL2525M12	00038417	25	25	150	32,0	23,0	75,0	-6,0	-6,0	0,8	SN..1204..

Spare Parts

For size	Insert lever	Insert shim	Lever key	Lever screw	Punch	Shim pin
...12	PP4713	PSN120312	3SMS795	LS0818	MP0912	RP6757
...19	PP7521	PSN190412	4SMS795	LS1027	MP1519	RP9811
...25	PP1325	PSN250624	5SMS795	LS1236	MP25	RP1312

Accessories

For size	Insert clamping torque	Replacement blade	Torque key
...12	-	-	-
...19	5.0NM	H00T-4.0	H00T-4050
...25	5.0NM	H00T-5.0	H00T-5050

PSSNR/L – Toolholders for inserts SNGA, SNMA, SNMG and SNMM – Metric

PSSNR/L
KAPR = 45,0°

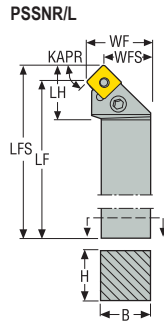
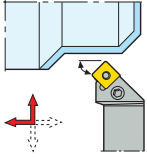







CTWS



- For inserts program, see page(s) 550, 551, 552, 553, 585
- GAMO° = Rake angle, LAMS° = Inclination angle
- CTWS = Insert shape and size
- For holder code key, see page(s) 15-16
- Right-hand version shown
- Please check availability at www.secotools.com / Seco Online Store

Designation	Item number	H	B	LF	LFS	WF	WFS	LH	KAPR°	GAMO°	LAMS°	Weight	CTWS
		mm	mm	mm	mm	mm	mm	mm				kg	
PSSNR2020K12	00038398	20	20	125	133,3	25,0	16,7	28,0	45,0	-8,0	0,0	0,4	SN..1204..
PSSNR2525M12	00038399	25	25	150	158,7	32,0	23,7	28,0	45,0	-8,0	0,0	0,8	SN..1204..
PSSNR3225P12	00038400	32	25	170	178,7	32,0	23,7	29,0	45,0	-8,0	0,0	1,1	SN..1204..
PSSNL2020K12	00038401	20	20	125	133,3	25,0	16,7	28,0	45,0	-8,0	0,0	0,4	SN..1204..
PSSNL2525M12	00038402	25	25	150	158,7	32,0	23,7	28,0	45,0	-8,0	0,0	0,8	SN..1204..
PSSNL3225P12	00038403	32	25	170	178,3	32,0	23,7	29,0	45,0	-8,0	0,0	1,1	SN..1204..

Spare Parts

For size	Insert lever	Insert shim	Lever key	Lever screw	Punch	Shim pin
...12	 PP4713	 PSN120312	 3SMS795	 LS0818	 MP0912	 RP6757

General ISO Turning
Holders

Steadyline®

MDT

Mini-Shaft™

Grooving

Parting-off

X4

Adapters
Clamping units

Accessories and
Spare parts

Workpiece
materials

PTAPRS/LS – Toolholders for inserts TPMM – Inch

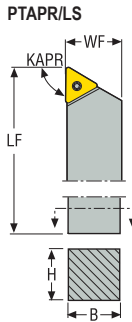

PTAPRS/LS
KAPR = 90,0 °

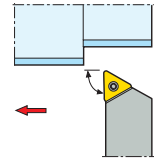

CTWS



- For inserts program, see page(s) 562
- GAMO° = Rake angle, LAMS° = Inclination angle
- CTWS = Insert shape and size
- For holder code key, see page(s) 17-18
- Neutral version shown
- Please check availability at www.secotools.com / Seco Online Store

Designation	Item number	H	B	LF	WF	KAPR°	GAMO°	LAMS°	Weight	CTWS
		Inch	Inch	Inch	Inch				lbs	
PTAPRS-8-2.5	00015715	0.500	0.500	4.500	0.512	90,0	5,0	0,0	0.440	TPMM2.52.
PTAPLS-8-2.5	00015720	0.500	0.500	4.500	0.512	90,0	5,0	0,0	0.660	TPMM2.52.

Spare Parts

For size	Insert pin
...-2.5	 PL-2.53

General ISO Turning Holders
Steadyline®
MDT
Mini-Shaft™
Grooving
Parting-off
X4
Adapters Clamping units
Accessories and Spare parts
Workpiece materials

PTBNR/L and PTNRR/L – Toolholders for inserts TNGA, TNMA, TNMG and TNMM – Metric

PTBNR/L
KAPR = 75,0°

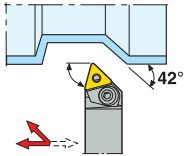

PTNRR/L
KAPR = 63,0°

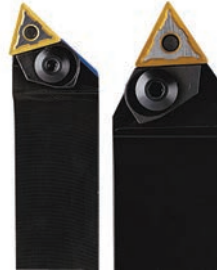
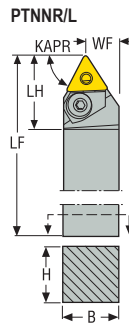
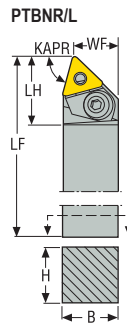
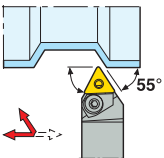

- For inserts program, see page(s) 558, 559, 560, 561, 590
- GAMO° = Rake angle, LAMS° = Inclination angle
- CTWS = Insert shape and size
- For holder code key, see page(s) 15-16
- Right-hand version shown
- Please check availability at www.secotools.com / Seco Online Store

Designation	Item number	H	B	LF	WF	LH	KAPR°	GAMO°	LAMS°	Weight	CTWS
		mm	mm	mm	mm	mm				kg	
PTBNR2525M16	00092429	25	25	150	22,0	26,0	75,0	-5,0	-6,0	0,7	TN..1604..
PTBNL2525M16	00092432	25	25	150	22,0	26,0	75,0	-5,0	-6,0	0,7	TN..1604..
PTNRR3225P16	00092433	32	25	170	13,0	28,0	63,0	-6,0	-5,0	1,0	TN..1604..
PTNRL3225P16	00092434	32	25	170	13,0	28,0	63,0	-6,0	-5,0	1,0	TN..1604..
PTNRR3225P22	00092435	32	25	170	13,0	34,0	63,0	-6,0	-5,0	1,0	TN..2204..
PTNRL3225P22	75009726	50	32	150	16,5	34,0	63,0	-6,0	-5,0	1,7	TN..2204..
PTNRR5032M22	00092438	32	25	170	13,0	34,0	63,0	-6,0	-5,0	1,0	TN..2204..
PTNRL5032M22	75009727	50	32	150	16,5	34,0	63,0	-6,0	-5,0	1,7	TN..2204..

Spare Parts

For size	Insert shim	Shim pin	Wedge clamp	Wedge key	Wedge screw
R25...16					
R25...16	117.26-622	PP2009-T09P	110.26-641.1	3SMS795	117.26-655.1
L25...16	117.26-622	PP2009-T09P	110.26-640.1	3SMS795	117.26-655.1
R32...16	117.26-622	PP2009-T09P	110.26-640.1	3SMS795	117.26-655.1
L32...16	117.26-622	PP2009-T09P	110.26-641.1	3SMS795	117.26-655.1
R...22	170.26-624	PP2015-1-T15P	110.26-642.1	4SMS795	170.26-655
L...22	170.26-624	PP2015-1-T15P	110.26-643.1	4SMS795	170.26-655

Accessories

For size	Insert clamping torque	Replacement blade	Shim key	Torque key
R25...16				
R25...16	5.0NM	H00T-3.0	T09P-2	H00T-3050
L25...16	5.0NM	H00T-3.0	T09P-2	H00T-3050
R32...16	5.0NM	H00T-3.0	T09P-2	H00T-3050
L32...16	5.0NM	H00T-3.0	T09P-2	H00T-3050
R...22	6.0NM	H00T-4.0	T15P-2	H00T-4060
L...22	6.0NM	H00T-4.0	T15P-2	H00T-4060

General ISO Turning Holders
Steadyline®
MDT
Mini-Shaft™
Grooving
Parting-off
X4
Adapters Clamping units
Accessories and Spare parts
Workpiece materials

PTGNR/L, -..A – Toolholders for inserts TNGA, TNMA, TNMG and TNMM – Metric

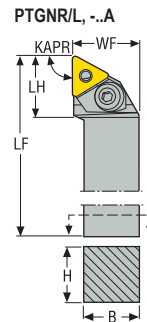

PTGNR/L, -..A
KAPR = 90,0°

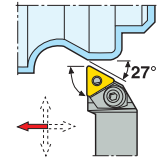

CTWS







- For inserts program, see page(s) 558, 559, 560, 561, 590
- GAMO° = Rake angle, LAMS° = Inclination angle
- CTWS = Insert shape and size
- For holder code key, see page(s) 15-16
- Right-hand version shown
- Please check availability at www.secotools.com / Seco Online Store

Designation	Item number	H	B	LF	WF	LH	KAPR°	GAMO°	LAMS°	Weight	CTWS
		mm	mm	mm	mm	mm				kg	
PTGNR1616-11A	75011261	16	16	100	20,0	16,0	90,0	-5,0	-6,0	0,2	TN..1103..
PTGNL1616-11A	75011262	16	16	100	20,0	16,0	90,0	-5,0	-6,0	0,2	TN..1103..
PTGNR2020K16	00092181	20	20	125	25,0	23,0	90,0	-5,0	-6,0	0,4	TN..1604..
PTGNR2525M16	00092228	25	25	150	32,0	23,0	90,0	-5,0	-6,0	0,7	TN..1604..
PTGNR3225P16	00092319	32	25	170	32,0	23,0	90,0	-5,0	-6,0	1,1	TN..1604..
PTGNL2020K16	00092224	20	20	125	25,0	23,0	90,0	-5,0	-6,0	0,4	TN..1604..
PTGNL2525M16	00091326	25	25	150	32,0	23,0	90,0	-5,0	-6,0	0,8	TN..1604..
PTGNL3225P16	00092321	32	25	170	32,0	23,0	90,0	-5,0	-6,0	1,1	TN..1604..
PTGNR2525M22	00091446	25	25	150	32,0	29,0	90,0	-5,0	-6,0	0,8	TN..2204..
PTGNR3232P22	00092426	32	32	170	40,0	29,0	90,0	-5,0	-6,0	1,3	TN..2204..
PTGNL2525M22	00092413	25	25	150	32,0	29,0	90,0	-5,0	-6,0	0,8	TN..2204..
PTGNL3232P22	00092427	32	32	170	40,0	29,0	90,0	-5,0	-6,0	1,3	TN..2204..
PTGNR4040T27	75004457	40	40	300	50,0	38,0	90,0	-5,0	-6,0	3,6	TN..2706..
PTGNL4040T27	75004456	40	40	300	50,0	38,0	90,0	-5,0	-6,0	3,6	TN..2706..

Spare Parts

For size	Insert shim	Locking screw	Nut	Punch	Shim pin	Wedge clamp	Wedge key	Wedge screw
R...11	117.26-620	136.26-654	-	-	117.26-654	110.26-639	2.5SMS795	117.26-657
L...11	117.26-620	136.26-654	-	-	117.26-654	110.26-638	2.5SMS795	117.26-657
R20...16	117.26-622	-	-	-	PP2009-T09P	110.26-641.1	3SMS795	117.26-655
R25/32...16	117.26-622	-	-	-	PP2009-T09P	110.26-641.1	3SMS795	117.26-655.1
L20...16	117.26-622	-	-	-	PP2009-T09P	110.26-640.1	3SMS795	117.26-655
L25/32...16	117.26-622	-	-	-	PP2009-T09P	110.26-640.1	3SMS795	117.26-655.1
R...22	170.26-624	-	-	-	PP2015-1-T15P	110.26-643.1	4SMS795	170.26-655
L...22	170.26-624	-	-	-	PP2015-1-T15P	110.26-642.1	4SMS795	170.26-655
R...27	117.26-628	-	170.26-651	117.26-687	126.26-650	110.26-645	5SMS795	110.26-655
L...27	117.26-628	-	170.26-651	117.26-687	126.26-650	110.26-644	5SMS795	110.26-655

Accessories

For size	Insert clamping torque 	Replacement blade 	Shim key 	Torque key 
R...11	3.0NM	H00-2.5	2SMS795	H00-2530
L...11	3.0NM	H00-2.5	2SMS795	H00-2530
R20...16	5.0NM	H00T-3.0	T09P-2	H00T-3050
R25/32...16	5.0NM	H00T-3.0	T09P-2	H00T-3050
L20...16	5.0NM	H00T-3.0	T09P-2	H00T-3050
L25/32...16	5.0NM	H00T-3.0	T09P-2	H00T-3050
R...22	6.0NM	H00T-4.0	T15P-2	H00T-4060
L...22	6.0NM	H00T-4.0	T15P-2	H00T-4060
R...27	10.0NM	H00T-6.0	4SMS795	H00T-60100
L...27	10.0NM	H00T-6.0	4SMS795	H00T-60100

- General ISO Turning Holders
- Steadyline®
- MDT
- Mini-Shaft™
- Grooving
- Parting-off
- X4
- Adapters Clamping units
- Accessories and Spare parts
- Workpiece materials

PTJNR/L – Toolholders for inserts TNGA, TNMA, TNMG, TNMM and TNMX – Metric

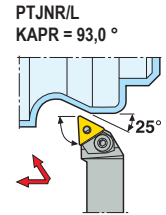
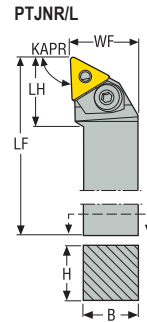

CTWS





- For inserts program, see page(s) 558, 559, 560, 561, 590, 593
- GAMO° = Rake angle, LAMS° = Inclination angle
- CTWS = Insert shape and size
- For holder code key, see page(s) 15-16
- Right-hand version shown
- Please check availability at www.secotools.com / Seco Online Store

Designation	Item number	H	B	LF	WF	LH	KAPR°	GAMO°	LAMS°	Weight	CTWS
		mm	mm	mm	mm	mm				kg	
PTJNR2020K16	00092147	20	20	125	25,0	23,0	93,0	-5,0	-6,0	0,4	TN..1604..
PTJNR2525M16	00092153	25	25	150	32,0	23,0	93,0	-5,0	-6,0	0,7	TN..1604..
PTJNR3232P16	00092156	32	32	170	40,0	23,0	93,0	-5,0	-6,0	1,3	TN..1604..
PTJNL2020K16	00092149	20	20	125	25,0	23,0	93,0	-5,0	-6,0	0,4	TN..1604..
PTJNL2525M16	00092155	25	25	150	32,0	23,0	93,0	-5,0	-6,0	0,7	TN..1604..
PTJNL3232P16	00092159	32	32	170	40,0	23,0	93,0	-5,0	-6,0	1,3	TN..1604..
PTJNR2525M22	00092161	25	25	150	32,0	29,0	93,0	-5,0	-6,0	0,8	TN..2204..
PTJNR3232P22	00091023	32	32	170	40,0	29,0	93,0	-5,0	-6,0	1,3	TN..2204..
PTJNR4032R22	00092178	40	32	200	40,0	29,0	93,0	-5,0	-6,0	2,0	TN..2204..
PTJNL2525M22	00092162	25	25	150	32,0	29,0	93,0	-5,0	-6,0	0,8	TN..2204..
PTJNL3232P22	00092177	32	32	170	40,0	29,0	93,0	-5,0	-6,0	1,3	TN..2204..
PTJNL4032R22	00092179	40	32	200	40,0	29,0	93,0	-5,0	-6,0	2,0	TN..2204..

Spare Parts

For size	Insert shim	Shim pin	Wedge clamp	Wedge key	Wedge screw
R20...16					
R25/32...16	117.26-622	PP2009-T09P	110.26-641.1	3SMS795	117.26-655
L20...16	117.26-622	PP2009-T09P	110.26-640.1	3SMS795	117.26-655
L25/32...16	117.26-622	PP2009-T09P	110.26-640.1	3SMS795	117.26-655.1
R...22	170.26-624	PP2015-1-T15P	110.26-643.1	4SMS795	170.26-655
L...22	170.26-624	PP2015-1-T15P	110.26-642.1	4SMS795	170.26-655

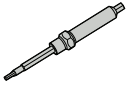
Accessories

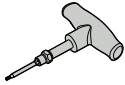
For size	Insert clamping torque 	Replacement blade 	Shim key 	Torque key 
R20...16	5.0NM	H00T-3.0	T09P-2	H00T-3050
R25/32...16	5.0NM	H00T-3.0	T09P-2	H00T-3050
L20...16	5.0NM	H00T-3.0	T09P-2	H00T-3050
L25/32...16	5.0NM	H00T-3.0	T09P-2	H00T-3050
R...22	6.0NM	H00T-4.0	T15P-2	H00T-4060
L...22	6.0NM	H00T-4.0	T15P-2	H00T-4060

General ISO Turning
Holders

Steadyline®

MDT

Mini-Shaft™

Grooving

Parting-off

X4

Adapters
Clamping units

Accessories and
Spare parts

Workpiece
materials

PTTNR/L – Toolholders for inserts TNGA, TNMA, TNMG and TNMM – Metric

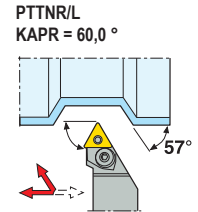
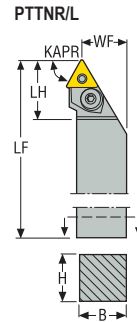

CTWS



- For inserts program, see page(s) 558, 559, 560, 561, 590
- GAMO° = Rake angle, LAMS° = Inclination angle
- CTWS = Insert shape and size
- For holder code key, see page(s) 15-16
- Right-hand version shown
- Please check availability at www.secotools.com / Seco Online Store

Designation	Item number	H	B	LF	WF	LH	KAPR°	GAMO°	LAMS°	Weight	CTWS
		mm	mm	mm	mm	mm				kg	
PTTNR2020K16	00092439	20	20	125	17,0	28,0	60,0	-6,0	-5,0	0,4	TN..1604..
PTTNR2525M16	00092486	25	25	150	22,0	28,0	60,0	-6,0	-5,0	0,8	TN..1604..
PTTNR2020K16	00092473	20	20	125	17,0	28,0	60,0	-6,0	-5,0	0,4	TN..1604..
PTTNR2525M16	00092522	25	25	150	22,0	28,0	60,0	-6,0	-5,0	0,8	TN..1604..

Spare Parts

For size	Insert shim	Shim pin	Wedge clamp	Wedge key	Wedge screw
R20...16					
R20...16	117.26-622	PP2009-T09P	110.26-641.1	3SMS795	117.26-655
R25...16	117.26-622	PP2009-T09P	110.26-641.1	3SMS795	117.26-655.1
L20...16	117.26-622	PP2009-T09P	110.26-640.1	3SMS795	117.26-655
L25...16	117.26-622	PP2009-T09P	110.26-640.1	3SMS795	117.26-655.1

Accessories

For size	Insert clamping torque	Replacement blade	Shim key	Torque key
R20...16				
R20...16	5.0NM	H00T-3.0	T09P-2	H00T-3050
R25...16	5.0NM	H00T-3.0	T09P-2	H00T-3050
L20...16	5.0NM	H00T-3.0	T09P-2	H00T-3050
L25...16	5.0NM	H00T-3.0	T09P-2	H00T-3050

PWLNRL/L – Toolholders for inserts WNGA, WNGG, WNMA, WNMG and WNMM – Metric

PWLNRL/L
KAPR = 95,0°

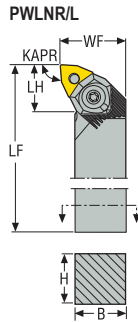
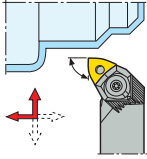

- For inserts program, see page(s) 568, 569, 570, 571, 596
- GAMO° = Rake angle, LAMS° = Inclination angle
- CTWS = Insert shape and size
- For holder code key, see page(s) 15-16
- Right-hand version shown
- * Use the right shim & the right screw for the selected insert. For details, see page 99
- Please check availability at www.secotools.com / Seco Online Store

Designation	Item number	H	B	LF	WF	LH	KAPR°	GAMO°	LAMS°	Weight	CTWS
		mm	mm	mm	mm	mm				kg	
PWLNRL1616H06	75079504	16	16	100	20,0	21,0	95,0	-6,0	-6,0	0,2	WN..0604..
PWLNRL2020K06	75028482	20	20	125	25,0	21,0	95,0	-6,0	-6,0	0,4	WN..0604..
PWLNRL2525M06	75028231	25	25	150	32,0	21,0	95,0	-6,0	-6,0	0,7	WN..0604..
PWLNRL3232P06	75036498	32	32	170	40,0	21,0	95,0	-6,0	-6,0	1,4	WN..0604..
PWLNRL1616H08	75079505	16	16	100	20,0	21,0	95,0	-6,0	-6,0	0,2	WN..0604..
PWLNRL2020K08	75028483	20	20	125	25,0	21,0	95,0	-6,0	-6,0	0,4	WN..0604..
PWLNRL2525M08	75027880	25	25	150	32,0	21,0	95,0	-6,0	-6,0	0,7	WN..0604..
PWLNRL3232P08	75036499	32	32	170	40,0	21,0	95,0	-6,0	-6,0	1,4	WN..0604..
PWLNRL2020K08	75027855	20	20	125	25,0	27,0	95,0	-6,0	-6,0	0,4	WN..0804/WN..0806*
PWLNRL2525M08	75027854	25	25	150	32,0	27,0	95,0	-6,0	-6,0	0,8	WN..0804/WN..0806*
PWLNRL3232P08	75027852	32	32	170	40,0	27,0	95,0	-6,0	-6,0	1,3	WN..0804/WN..0806*
PWLNRL2020K08	75027856	20	20	125	25,0	27,0	95,0	-6,0	-6,0	0,4	WN..0804/WN..0806*
PWLNRL2525M08	75027465	25	25	150	32,0	27,0	95,0	-6,0	-6,0	0,8	WN..0804/WN..0806*
PWLNRL3232P08	75027853	32	32	170	40,0	27,0	95,0	-6,0	-6,0	1,3	WN..0804/WN..0806*

Spare Parts

For size	Insert shim	Setting screw	Shim pin	Wedge clamp	Wedge key	Wedge screw
...H06	WAE060312	L82511-T07P	PP1409-T09P	WNW06HD	T20P-7	WS1920-T20P
...06	WAE060312	L82511-T07P	PP2109-T09P	WNW06HD	T20P-7	WS1920-T20P
...08	WAE080412	L82511-T07P	PP2015-1-T15P	WNW08HD	T25P-7	WS2325-T25P

Accessories

For size	Insert clamping torque	Replacement blade	Shim key	Torque key
...H06	3.5NM	T00-20P	T09P-2	T00-20P35
...06	3.5NM	T00-20P	T09P-2	T00-20P35
...08	5.0NM	T00T-25P	T15P-2	T00T-25P50

SCACR/L – Toolholders for inserts CCGT, CCGW, CCMT and CCMW – Metric

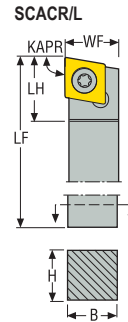

SCACR/L
KAPR = 90,0 °

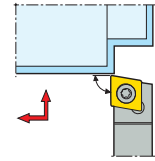

CTWS



- For inserts program, see page(s) 522, 523, 524, 525, 573, 574, 597, 599
- GAMO° = Rake angle, LAMS° = Inclination angle
- CTWS = Insert shape and size
- For holder code key, see page(s) 15-16
- Right-hand version shown
- Please check availability at www.secotools.com / Seco Online Store

Designation	Item number	H	B	LF	WF	LH	KAPR°	GAMO°	LAMS°	Weight	CTWS
		mm	mm	mm	mm	mm				kg	
SCACR0808K06	00042836	8	8	125	8,7	9,0	90,0	0,0	0,0	0,1	CC..0602..
SCACR1010M06	00042837	10	10	150	10,7	9,0	90,0	0,0	0,0	0,2	CC..0602..
SCACR1212M06	02430771	12	12	150	12,7	9,0	90,0	0,0	0,0	0,2	CC..0602..
SCACL0808K06	75011227	8	8	125	8,7	9,0	90,0	0,0	0,0	0,1	CC..0602..
SCACL1010M06	75011228	10	10	150	10,7	9,0	90,0	0,0	0,0	0,2	CC..0602..
SCACL1212M06	02430823	12	12	150	12,7	9,0	90,0	0,0	0,0	0,2	CC..0602..
SCACR1212M09	00042839	12	12	150	12,7	13,0	90,0	0,0	0,0	0,2	CC..09T3..
SCACR1414M09	00042841	14	14	150	14,7	13,0	90,0	0,0	0,0	0,3	CC..09T3..
SCACR1616H09	02430826	16	16	100	16,7	21,0	90,0	0,0	0,0	0,2	CC..09T3..
SCACL1212M09	75011229	12	12	150	12,7	13,0	90,0	0,0	0,0	0,2	CC..09T3..
SCACL1414M09	75011230	14	14	150	14,7	13,0	90,0	0,0	0,0	0,3	CC..09T3..
SCACL1616H09	02430830	16	16	100	16,7	21,0	90,0	0,0	0,0	0,2	CC..09T3..

Spare Parts

For size	Insert key	Insert screw
...06	 T07P-2	 C02506-T07P
...09	 T15P-2	 C04008-T15P

Accessories

For size	Insert clamping torque	Replacement blade	Torque key
...06	 0.9NM	 T00-07P	 T00-07P09
...09	3.5NM	T00-15P	T00-15P35

SCBCR/L – Toolholders for inserts CCGT, CCMT and CCGW..-LF – Metric

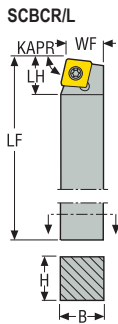
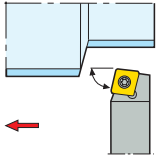

SCBCR/L
KAPR = 75,0°





- For inserts program, see page(s) 522, 523, 524, 525, 573, 574, 597
- GAMO° = Rake angle, LAMS° = Inclination angle
- CTWS = Insert shape and size
- For holder code key, see page(s) 15-16
- Right-hand version shown
- Please check availability at www.secotools.com / Seco Online Store

Designation	Item number	H	B	LF	WF	LH	KAPR°	GAMO°	LAMS°	Weight	CTWS
		mm	mm	mm	mm	mm				kg	
SCBCR1616H09	02484500	16	16	100	13,0	12,0	75,0	0,0	0,0	0,2	CC..0903..
SCBCR2020K09	02484537	20	20	125	17,0	12,0	75,0	0,0	0,0	0,4	CC..0903..
SCBCL1616H09	02484534	16	16	100	13,0	12,0	75,0	0,0	0,0	0,2	CC..0903..
SCBCL2020K09	02484540	20	20	125	17,0	12,0	75,0	0,0	0,0	0,4	CC..0903..

Spare Parts

For size	Insert key	Insert screw
...09	 T15P-2	 C04008-T15P

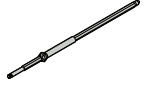
Accessories

For size	Insert clamping torque	Replacement blade	Torque key
...09	 3.5NM	 T00-15P	 T00-15P35

General ISO Turning Holders
Steadyline®
MDT
Mini-Shaft™
Grooving
Parting-off
X4
Adapters Clamping units
Accessories and Spare parts
Workpiece materials

SCDCR/L and SCFCR/L – Toolholders for inserts CCGT, CCGW, CCMT and CCMW – Metric

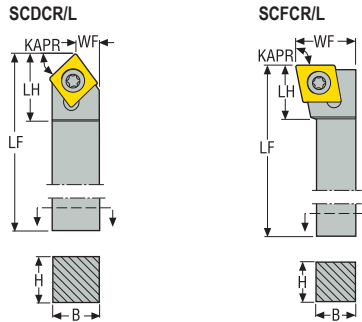

SCDCR/L
KAPR = 45,0 °

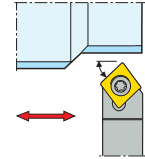

SCFCR/L
KAPR = 90,0 °

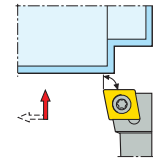





CTWS





- For inserts program, see page(s) 522, 523, 524, 525, 573, 574, 597, 599
- GAMO° = Rake angle, LAMS° = Inclination angle
- CTWS = Insert shape and size
- For holder code key, see page(s) 15-16
- Right-hand version shown
- Please check availability at www.secotools.com / Seco Online Store

Designation	Item number	H	B	LF	WF	LH	KAPR°	GAMO°	LAMS°	Weight	CTWS
		mm	mm	mm	mm	mm				kg	
SCDCR0808K06	02435799	8	8	125	4,2	11,0	45,0	0,0	0,0	0,1	CC..0602..
SCDCR1010M06	02435801	10	10	150	5,2	11,0	45,0	0,0	0,0	0,2	CC..0602..
SCDCL0808K06	02435800	8	8	125	4,2	11,0	45,0	0,0	0,0	0,1	CC..0602..
SCDCL1010M06	02201468	10	10	150	5,2	11,0	45,0	0,0	0,0	0,2	CC..0602..
SCDCR1212M09	02435816	12	12	150	6,2	21,0	45,0	0,0	0,0	0,2	CC..09T3..
SCDCR1414M09	02435819	14	14	150	7,2	21,0	45,0	0,0	0,0	0,3	CC..09T3..
SCDCL1212M09	02435818	12	12	150	6,2	21,0	45,0	0,0	0,0	0,2	CC..09T3..
SCDCL1414M09	02435821	14	14	150	7,2	21,0	45,0	0,0	0,0	0,3	CC..09T3..
SCFCR0808D06	75011627	8	8	60	10,0	9,0	90,0	0,0	0,0	0,1	CC..0602..
SCFCR1212F09	75011631	12	12	80	16,0	15,0	90,0	0,0	0,0	0,1	CC..09T3..
SCFCL1212F09	75011632	12	12	80	16,0	15,0	90,0	0,0	0,0	0,1	CC..09T3..

Spare Parts

For size	Insert key	Insert screw
...06	 T07P-2	 C02506-T07P
...09	 T15P-2	 C04008-T15P

Accessories

For size	Insert clamping torque	Replacement blade	Torque key
...06	 0.9NM	 T00-07P	 T00-07P09
...09	3.5NM	T00-15P	T00-15P35

SCGCR/L – Toolholders for inserts CCGT, CCGW, CCMT and CCMW – Metric



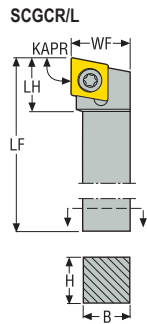
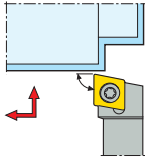

SCGCR/L
KAPR = 90,0°









- For inserts program, see page(s) 522, 523, 524, 525, 573, 574, 597, 599
- GAMO° = Rake angle, LAMS° = Inclination angle
- CTWS = Insert shape and size
- For holder code key, see page(s) 15-16
- Right-hand version shown
- Please check availability at www.secotools.com / Seco Online Store

Designation	Item number	H	B	LF	WF	LH	KAPR°	GAMO°	LAMS°	Weight	CTWS
		mm	mm	mm	mm	mm				kg	
SCGCR0808D06	75011508	8	8	60	10,0	11,0	90,0	0,0	0,0	0,1	CC..0602..
SCGCR1010E06	75011510	10	10	70	12,0	11,0	90,0	0,0	0,0	0,1	CC..0602..
SCGCL1010E06	75011511	10	10	70	12,0	11,0	90,0	0,0	0,0	0,1	CC..0602..
SCGCR1212F09	75011512	12	12	80	16,0	15,0	90,0	0,0	0,0	0,1	CC..09T3..
SCGCL1212F09	75011513	12	12	80	16,0	15,0	90,0	0,0	0,0	0,1	CC..09T3..

Spare Parts

For size	Insert key	Insert screw
...06	 T07P-2	 C02506-T07P
...09	 T15P-2	 C04008-T15P

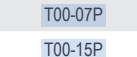
Accessories

For size	Insert clamping torque	Replacement blade	Torque key
...06	 0.9NM	 T00-07P	 T00-07P09
...09	 3.5NM	 T00-15P	 T00-15P35

SCGCR/L – Toolholders for inserts CCGT, CCGW, CCMT and CCMW – Inch

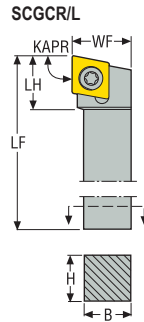

SCGCR/L
KAPR = 90,0 °

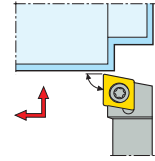

CTWS



- For inserts program, see page(s) 522, 523, 524, 525, 573, 574, 597, 599
- GAMO° = Rake angle, LAMS° = Inclination angle
- CTWS = Insert shape and size
- For holder code key, see page(s) 17-18
- Right-hand version shown
- Please check availability at www.secotools.com / Seco Online Store

Designation	Item number	H	B	LF	WF	LH	KAPR°	GAMO°	LAMS°	Weight	CTWS
		Inch	Inch	Inch	Inch	Inch				lbs	
SCGCR-8-3	00013326	0.500	0.500	3.500	0.625	0.620	90,0	0,0	0,0	0.440	CC..32.5.
SCGCL-8-3	00013327	0.500	0.500	3.500	0.625	0.620	90,0	0,0	0,0	0.440	CC..32.5.

Spare Parts

For size	Insert key	Insert screw
...3	 T15P-2	 C04008-T15P

Accessories

For size	Insert clamping torque	Replacement blade	Torque key
...3	 31.0IN.LBS	 T00-15P	 T00-15P35

General ISO Turning Holders
Steadyline®
MDT
Mini-Shaft™
Grooving
Parting-off
X4
Adapters Clamping units
Accessories and Spare parts
Workpiece materials

SCLCR/L – Toolholders for inserts CCGT, CCGW, CCMT and CCMW – Metric

SCLCR/L
KAPR = 95,0°

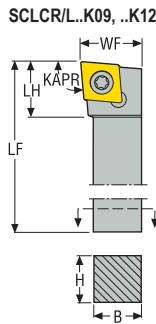
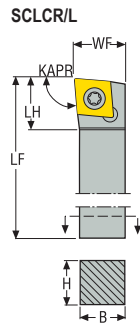
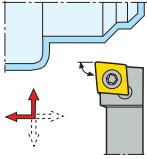

- For inserts program, see page(s) 522, 523, 524, 525, 573, 574, 597, 599
- GAMO° = Rake angle, LAMS° = Inclination angle
- CTWS = Insert shape and size
- For holder code key, see page(s) 15-16
- Right-hand version shown
- Please check availability at www.secotools.com / Seco Online Store

Designation	Item number	H	B	LF	WF	LH	KAPR°	GAMO°	LAMS°	Weight	CTWS
		mm	mm	mm	mm	mm				kg	
SCLCR0808K06	02435777	8	8	125	8,5	9,0	95,0	0,0	0,0	0,1	CC..0602..
SCLCR1010M06	02435793	10	10	150	10,5	9,0	95,0	0,0	0,0	0,2	CC..0602..
SCLCR1212M06	02430832	12	12	150	12,5	8,0	95,0	0,0	0,0	0,2	CC..0602..
SCLCL0808K06	02435781	8	8	125	8,5	9,0	95,0	0,0	0,0	0,1	CC..0602..
SCLCL1010M06	02435796	10	10	150	10,5	9,0	95,0	0,0	0,0	0,2	CC..0602..
SCLCL1212M06	02430836	12	12	150	12,5	8,0	95,0	0,0	0,0	0,2	CC..0602..
SCLCR1212M09	02435797	12	12	150	12,5	12,0	95,0	0,0	0,0	0,2	CC..09T3..
SCLCR1616H09	75011182	16	16	100	16,5	12,0	95,0	0,0	0,0	0,2	CC..09T3..
SCLCR2020K09	00092187	20	20	125	25,0	20,0	95,0	0,0	0,0	0,4	CC..09T3..
SCLCL1212M09	02435798	12	12	150	12,5	12,0	95,0	0,0	0,0	0,2	CC..09T3..
SCLCL1616H09	75011181	16	16	100	16,5	12,0	95,0	0,0	0,0	0,3	CC..09T3..
SCLCL2020K09	00092188	20	20	125	25,0	20,0	95,0	0,0	0,0	0,5	CC..09T3..
SCLCR2020K12	75011878	20	20	125	25,0	20,0	95,0	0,0	0,0	0,4	CC..1204..
SCLCL2020K12	75011879	20	20	125	25,0	20,0	95,0	0,0	0,0	0,4	CC..1204..

Spare Parts

For size	Insert key	Insert screw	Insert shim	Shim screw
...06	T07P-2	C02506-T07P	-	-
...09	T15P-2	C04008-T15P	-	-
...12	T15P-2	C05012-T15P	123.19-621	CA5008

Accessories

For size	Insert clamping torque	Replacement blade	Shim key	Torque key
...06	0.9NM	T00-07P	-	T00-07P09
...09	3.5NM	T00-15P	-	T00-15P35
...12	5.0NM	T00-15P	5SMS795	T00-15P50

General ISO Turning Holders
Steadyline®
MDT
Mini-Shaft™
Grooving
Parting-off
X4
Adapters Clamping units
Accessories and Spare parts
Workpiece materials

SCLCR/L – Toolholders for inserts CCGT, CCGW, CCMT and CCMW – Inch

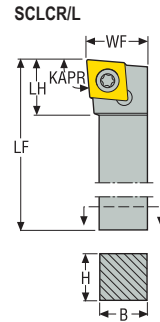

SCLCR/L
KAPR = 95,0 °

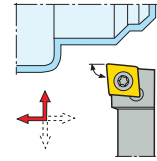

CTWS



- For inserts program, see page(s) 522, 523, 524, 525, 573, 574, 597, 599
- GAMO° = Rake angle, LAMS° = Inclination angle
- CTWS = Insert shape and size
- For holder code key, see page(s) 17-18
- Right-hand version shown
- Please check availability at www.secotools.com / Seco Online Store

Designation	Item number	H	B	LF	WF	LH	KAPR°	GAMO°	LAMS°	Weight	CTWS
		Inch	Inch	Inch	Inch	Inch				lbs	
SCLCR-6-2	00071951	0.375	0.375	2.500	0.500	0.480	95,0	0,0	0,0	0.220	CC..21.5.
SCLCL-6-2	00071943	0.375	0.375	2.500	0.500	0.480	95,0	0,0	0,0	0.220	CC..21.5.
SCLCR-8-3	00071949	0.500	0.500	3.500	0.625	0.670	95,0	0,0	0,0	0.440	CC..32.5.
SCLCR-10-3	00071955	0.625	0.625	4.000	0.750	0.690	95,0	0,0	0,0	0.660	CC..32.5.
SCLCR-12-3	00013336	0.750	0.750	4.500	1.000	0.690	95,0	0,0	0,0	0.880	CC..32.5.
SCLCR-16-3	00073924	1.000	1.000	6.000	1.250	0.670	95,0	0,0	0,0	1.980	CC..32.5.
SCLCL-8-3	00071945	0.500	0.500	3.500	0.625	0.670	95,0	0,0	0,0	0.440	CC..32.5.
SCLCL-10-3	00071931	0.625	0.625	4.000	0.750	0.690	95,0	0,0	0,0	0.660	CC..32.5.
SCLCL-12-3	00013337	0.750	0.750	4.500	1.000	0.690	95,0	0,0	0,0	0.880	CC..32.5.
SCLCL-16-3	00073925	1.000	1.000	6.000	1.252	0.670	95,0	0,0	0,0	1.980	CC..32.5.
SCLCR-16-4	00043250	1.000	1.000	6.000	1.250	0.780	95,0	0,0	0,0	1.540	CC..43.
SCLCL-16-4	00043248	1.000	1.000	5.000	1.252	0.787	95,0	0,0	0,0	1.760	CC..43.

Spare Parts

For size	Insert key	Insert screw	Insert shim	Shim screw
...2	 T07P-2	 C02506-T07P	 -	 -
...3	 T15P-2	 C04008-T15P	 -	 -
...4	 T15P-2	 C05012-T15P	 123.19-621	 CA5008

Accessories

For size	Insert clamping torque	Replacement blade	Shim key	Torque key
...2	 8.0IN.LBS	 T00-07P	 -	 T00-07P09
...3	 31.0IN.LBS	 T00-15P	 -	 T00-15P35
...4	 44.3IN.LBS	 T00-15P	 5SMS795	 T00-15P50

SCMCN – Toolholders for inserts CCGT, CCGW, CCMT and CCMW – Inch



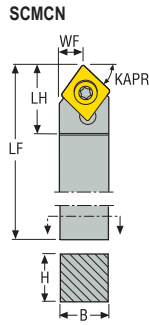
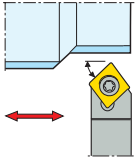

SCMCN
KAPR = 50,0°







- For inserts program, see page(s) 522, 523, 524, 525, 573, 574, 597, 599
- GAMO° = Rake angle, LAMS° = Inclination angle
- CTWS = Insert shape and size
- For holder code key, see page(s) 17-18
- Right-hand version shown
- Please check availability at www.secotools.com / Seco Online Store

Designation	Item number	H	B	LF	WF	LH	KAPR°	GAMO°	LAMS°	Weight	CTWS
		Inch	Inch	Inch	Inch	Inch				lbs	
SCMCN-6-2	00013318	0.375	0.375	2.500	0.187	0.420	50,0	0,0	0,0	0.220	CC..21.5.
SCMCN-8-3	00013319	0.500	0.500	3.500	0.264	0.610	50,0	0,0	0,0	0.440	CC..32.5.

Spare Parts

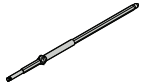
For size	Insert key	Insert screw
..-2	 T07P-2	 C02506-T07P
..-3	 T15P-2	 C04008-T15P

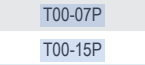
Accessories

For size	Insert clamping torque	Replacement blade	Torque key
..-2	 8.0IN.LBS	 T00-07P	 T00-07P09
..-3	 31.0IN.LBS	 T00-15P	 T00-15P35

General ISO Turning Holders
Steadyline®
MDT
Mini-Shaft™
Grooving
Parting-off
X4
Adapters Clamping units
Accessories and Spare parts
Workpiece materials

SCRCR/L – Toolholders for inserts CCGT, CCGW and CCMT – Inch

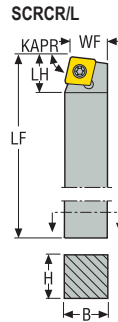

SCRCR
KAPR = 75,0 °

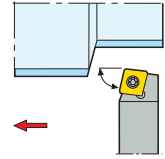

CTWS



- For inserts program, see page(s) 522, 523, 524, 525, 573, 574, 597
- GAMO° = Rake angle, LAMS° = Inclination angle
- CTWS = Insert shape and size
- For holder code key, see page(s) 17-18
- Shim DSN120416 for insert SN..1206.., to be ordered separately
- Right-hand version shown
- Please check availability at www.secotools.com / Seco Online Store

Designation	Item number	H	B	LF	WF	LH	KAPR°	GAMO°	LAMS°	Weight	CTWS
		Inch	Inch	Inch	Inch	Inch				lbs	
SCRCR-8-3	00013316	0.500	0.500	3.504	0.551	0.681	75.0	0,0	0,0	0.440	CC..32.5.

Spare Parts

For size	Insert key	Insert screw
..-3	 T15P-2	 C04008-T15P

Accessories

For size	Insert clamping torque	Replacement blade	Torque key
..-3	 31.0IN.LBS	 T00-15P	 T00-15P35

General ISO Turning Holders
Steadyline®
MDT
Mini-Shaft™
Grooving
Parting-off
X4
Adapters Clamping units
Accessories and Spare parts
Workpiece materials

SDACR/L – Toolholders for inserts DCGT, DCGW, DCMT and DCMW – Metric

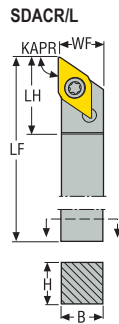
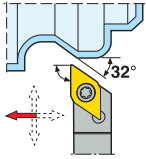

SDACR/L
KAPR = 90,0°







- For inserts program, see page(s) 534, 535, 536, 578, 600
- GAMO° = Rake angle, LAMS° = Inclination angle
- CTWS = Insert shape and size
- For holder code key, see page(s) 15-16
- Right-hand version shown
- Please check availability at www.secotools.com / Seco Online Store

Designation	Item number	H	B	LF	WF	LH	KAPR°	GAMO°	LAMS°	Weight	CTWS
		mm	mm	mm	mm	mm				kg	
SDACR0808K07	00042846	8	8	125	8,7	13,0	90,0	0,0	0,0	0,1	DC..0702..
SDACR1010M07	00069721	10	10	150	10,7	13,0	90,0	0,0	0,0	0,2	DC..0702..
SDACR1212M07	00079389	12	12	150	12,7	13,0	90,0	0,0	0,0	0,2	DC..0702..
SDACL0808K07	75011235	8	8	125	8,7	13,0	90,0	0,0	0,0	0,1	DC..0702..
SDACL1010M07	75011236	10	10	150	10,7	13,0	90,0	0,0	0,0	0,2	DC..0702..
SDACL1212M07	75011237	12	12	150	12,7	13,0	90,0	0,0	0,0	0,2	DC..0702..
SDACR1212M11	00042847	12	12	150	12,7	20,0	90,0	0,0	0,0	0,2	DC..11T3..
SDACR1414M11	00042849	14	14	150	14,7	20,0	90,0	0,0	0,0	0,3	DC..11T3..
SDACR1616H11	02430870	16	16	100	16,7	21,0	90,0	0,0	0,0	0,2	DC..11T3..
SDACL1212M11	75924226	12	12	150	12,7	20,0	90,0	0,0	0,0	0,2	DC..11T3..
SDACL1616H11	02430879	16	16	100	16,7	21,0	90,0	0,0	0,0	0,2	DC..11T3..

Spare Parts

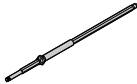
For size	Insert key	Insert screw
...07	 T07P-2	 C02506-T07P
...11	 T15P-2	 C04008-T15P

Accessories

For size	Insert clamping torque	Replacement blade	Torque key
...07	 0.9NM	 T00-07P	 T00-07P09
...11	 3.5NM	 T00-15P	 T00-15P35

SDHCR/L – Toolholders for inserts DCGT, DCGW, DCMT, DCMW and DCMX – Metric

General ISO Turning
Holders

Steadyline®

MDT

Mini-Shaft™

Grooving

Parting-off

X4

Adapters
Clamping units

Accessories and
Spare parts

Workpiece
materials

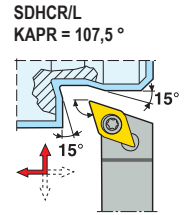
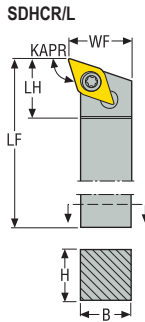





CTWS







- For inserts program, see page(s) 534, 535, 536, 578, 600
- GAMO° = Rake angle, LAMS° = Inclination angle
- CTWS = Insert shape and size
- For holder code key, see page(s) 15-16
- Right-hand version shown
- Please check availability at www.secotools.com / Seco Online Store

Designation	Item number	H	B	LF	WF	LH	KAPR°	GAMO°	LAMS°	Weight	CTWS
		mm	mm	mm	mm	mm				kg	
SDHCR1010M07	02435836	10	10	150	12,0	14,0	107,5	0,0	0,0	0,2	DC..0702..
SDHCL1010M07	02435841	10	10	150	12,0	14,0	107,5	0,0	0,0	0,2	DC..0702..
SDHCR1212M11	02435848	12	12	150	16,0	21,0	107,5	0,0	0,0	0,2	DC..11T3..
SDHCR1616H11	75011422	16	16	100	20,0	20,0	107,5	0,0	0,0	0,2	DC..11T3..
SDHCR2020K11	75011696	20	20	125	25,0	20,0	107,5	0,0	0,0	0,4	DC..11T3..
SDHCR2525M11	00092189	25	25	150	32,0	20,0	107,5	0,0	0,0	0,8	DC..11T3..
SDHCL1212M11	02435849	12	12	150	16,0	21,0	107,5	0,0	0,0	0,2	DC..11T3..
SDHCL1616H11	75011423	16	16	100	20,0	20,0	107,5	0,0	0,0	0,2	DC..11T3..
SDHCL2020K11	75011697	20	20	125	25,0	20,0	107,5	0,0	0,0	0,4	DC..11T3..
SDHCL2525M11	00092190	25	25	150	32,0	20,0	107,5	0,0	0,0	0,8	DC..11T3..
SDHCR2525M15	75011713	25	25	150	32,0	25,0	107,5	0,0	0,0	0,7	DC..1504..
SDHCL2525M15	75011714	25	25	150	32,0	25,0	107,5	0,0	0,0	0,7	DC..1504..

Spare Parts

For size	Insert key	Insert screw	Insert shim	Shim screw
...07	 T07P-2	 C02506-T07P	 -	 -
..12/16..11	T15P-2	C04008-T15P	-	-
..20/25..11	T15P-2	C03510-T15P	126.19-620	CA3510
...15	T15P-2	C04518-T15P	126.19-621	CA4512

Accessories

For size	Insert clamping torque	Replacement blade	Shim key	Torque key
...07	 0.9NM	 T00-07P	 -	 T00-07P09
..12/16..11	3.5NM	T00-15P	-	T00-15P35
..20/25..11	3.0NM	T00-15P	9/64SMS875	T00-15P30
...15	5.0NM	T00-15P	5SMS795	T00-15P50

SDJCR/L – Toolholders for inserts DCGT, DCGW, DCMT, DCMW and DCMX – Metric

SDJCR/L
KAPR = 93,0°

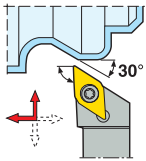

SDJCR/L..07, 1212M11,
1616H11

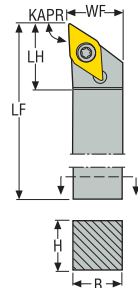

SDJCR/L

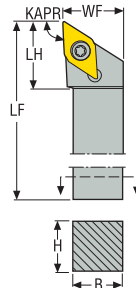

- For inserts program, see page(s) 534, 535, 536, 578, 600
- GAMO° = Rake angle, LAMS° = Inclination angle
- CTWS = Insert shape and size
- For holder code key, see page(s) 15-16
- Right-hand version shown
- Please check availability at www.secotools.com / Seco Online Store



Designation	Item number	H	B	LF	WF	LH	KAPR°	GAMO°	LAMS°	Weight	CTWS
		mm	mm	mm	mm	mm				kg	
SDJCR0808K07	02430880	8	8	125	8,5	13,0	93,0	0,0	0,0	0,1	DC..0702..
SDJCR1010M07	02435822	10	10	150	10,5	14,0	93,0	0,0	0,0	0,2	DC..0702..
SDJCR1212M07	02430896	12	12	150	12,5	13,0	93,0	0,0	0,0	0,2	DC..0702..
SDJCL0808K07	02430881	8	8	125	8,5	13,0	93,0	0,0	0,0	0,1	DC..0702..
SDJCL1010M07	02435824	10	10	150	10,5	14,0	93,0	0,0	0,0	0,2	DC..0702..
SDJCL1212M07	02430901	12	12	150	12,5	13,0	93,0	0,0	0,0	0,2	DC..0702..
SDJCR1212M11	02435826	12	12	150	12,5	20,0	93,0	0,0	0,0	0,2	DC..11T3..
SDJCR1616H11	75011180	16	16	100	16,5	20,0	93,0	0,0	0,0	0,2	DC..11T3..
SDJCR2020K11	75011274	20	20	125	25,0	20,0	93,0	0,0	0,0	0,4	DC..11T3..
SDJCR2525M11	00092199	25	25	150	32,0	25,0	93,0	0,0	0,0	0,7	DC..11T3..
SDJCL1212M11	02435827	12	12	150	12,5	20,0	93,0	0,0	0,0	0,2	DC..11T3..
SDJCL1616H11	75011179	16	16	100	16,5	20,0	93,0	0,0	0,0	0,2	DC..11T3..
SDJCL2020K11	75011275	20	20	125	25,0	20,0	93,0	0,0	0,0	0,4	DC..11T3..
SDJCL2525M11	00092200	25	25	150	32,0	25,0	93,0	0,0	0,0	0,7	DC..11T3..
SDJCR2525M15	75012040	25	25	150	32,0	28,0	93,0	0,0	0,0	0,7	DC..1504..
SDJCR3225P15	75012042	32	25	170	32,0	28,0	93,0	0,0	0,0	1,1	DC..1504..
SDJCL2525M15	75012041	25	25	150	32,0	28,0	93,0	0,0	0,0	0,7	DC..1504..
SDJCL3225P15	75012043	32	25	170	32,0	28,0	93,0	0,0	0,0	1,1	DC..1504..

Spare Parts

For size	Insert key	Insert screw	Insert shim	Shim screw
..07	T07P-2	C02506-T07P	-	-
..12/16..11	T15P-2	C04008-T15P	-	-
..20/25..11	T15P-2	C03510-T15P	126.19-620	CA3510
...15	T15P-2	C04518-T15P	126.19-621	CA4512

General ISO Turning Holders
Steadyline®
MDT
Mini-Shaft™
Grooving
Parting-off
X4
Adapters and Clamping units
Accessories and Spare parts
Workpiece materials

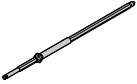
Accessories

For size	Insert clamping torque	Replacement blade	Shim key	Torque key
...07	0.9NM 	 T00-07P	- 	T00-07P09 
..12/16..11	3.5NM	T00-15P	-	T00-15P35
..20/25..11	3.0NM	T00-15P	9/64SMS875	T00-15P30
...15	5.0NM	T00-15P	5SMS795	T00-15P50

General ISO Turning
Holders

Steadyline®

MDT

Mini-Shaft™

Grooving

Parting-off

X4

Adapters
Clamping units

Accessories and
Spare parts

Workpiece
materials

SDJCR/L – Toolholders for inserts DCGT, DCGW, DCMT, DCMW and DCMX – Inch



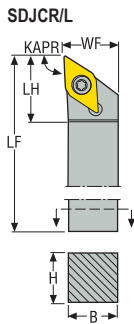
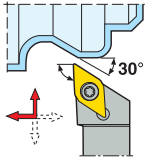

SDJCR/L
KAPR = 93,0°





- For inserts program, see page(s) 534, 535, 536, 578, 600
- GAMO° = Rake angle, LAMS° = Inclination angle
- CTWS = Insert shape and size
- For holder code key, see page(s) 17-18
- Right-hand version shown
- Please check availability at www.secotools.com / Seco Online Store

Designation	Item number	H	B	LF	WF	LH	KAPR°	GAMO°	LAMS°	Weight	CTWS
		Inch	Inch	Inch	Inch	Inch				lbs	
SDJCR-6-2	00071938	0.375	0.375	2.500	0.500	0.680	93,0	0,0	0,0	0.220	DC..21.5.
SDJCR-8-2	00013341	0.500	0.500	3.500	0.625	0.680	93,0	0,0	0,0	0.440	DC..21.5.
SDJCL-6-2	00071941	0.375	0.375	2.500	0.500	0.680	93,0	0,0	0,0	0.220	DC..21.5.
SDJCL-8-2	00013342	0.500	0.500	3.500	0.625	0.680	93,0	0,0	0,0	0.440	DC..21.5.
SDJCR-8-3	00071952	0.500	0.500	3.500	0.625	1.000	93,0	0,0	0,0	0.440	DC..32.5.
SDJCR-10-3	00071948	0.625	0.625	4.000	0.750	1.000	93,0	0,0	0,0	2.430	DC..32.5.
SDJCR-12-3	00043256	0.750	0.750	4.500	1.000	1.000	93,0	0,0	0,0	0.880	DC..32.5.
SDJCR-16-3	00073937	1.000	1.000	6.000	1.252	0.980	93,0	0,0	0,0	1.760	DC..32.5.
SDJCL-8-3	00071939	0.500	0.500	3.500	0.625	1.000	93,0	0,0	0,0	0.440	DC..32.5.
SDJCL-10-3	00071947	0.625	0.625	4.000	0.750	1.000	93,0	0,0	0,0	0.660	DC..32.5.
SDJCL-12-3	00043252	0.750	0.750	4.500	1.000	1.000	93,0	0,0	0,0	1.980	DC..32.5.
SDJCL-16-3	00073938	1.000	1.000	6.000	1.252	0.980	93,0	0,0	0,0	1.980	DC..32.5.

Spare Parts

For size	Insert key	Insert screw
..-2	 T07P-2	 C02506-T07P
..-3	 T15P-2	 C04008-T15P

Accessories

For size	Insert clamping torque	Replacement blade	Torque key
..-2	 8.0IN.LBS	 T00-07P	 T00-07P09
..-3	31.0IN.LBS	T00-15P	T00-15P35

General ISO Turning Holders
Steadyline®
MDT
Mini-Shaft™
Grooving
Parting-off
X4
Adapters Clamping units
Accessories and Spare parts
Workpiece materials

SDNCN – Toolholders for inserts DCGT, DCGW, DCMT and DCMW – Metric

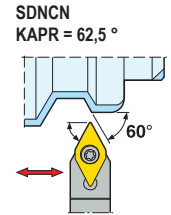
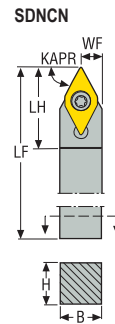

CTWS



- For inserts program, see page(s) 534, 535, 536, 578, 600
- GAMO° = Rake angle, LAMS° = Inclination angle
- CTWS = Insert shape and size
- For holder code key, see page(s) 15-16
- Neutral version shown
- Please check availability at www.secotools.com / Seco Online Store

Designation	Item number	H	B	LF	WF	LH	KAPR°	GAMO°	LAMS°	Weight	CTWS
		mm	mm	mm	mm	mm				kg	
SDNCN0808K07	02435828	8	8	125	4,2	16,0	62,5	0,0	0,0	0,1	DC..0702..
SDNCN1010M07	02435831	10	10	150	5,2	21,0	62,5	0,0	0,0	0,2	DC..0702..
SDNCN1212M07	00092195	12	12	150	6,2	20,0	62,5	0,0	0,0	0,2	DC..0702..
SDNCN1212M11	00092196	12	12	150	6,2	23,0	62,5	0,0	0,0	0,2	DC..11T3..
SDNCN1414M11	00089908	14	14	150	7,2	23,0	62,5	0,0	0,0	0,3	DC..11T3..
SDNCN1616H11	75011788	16	16	100	8,2	22,0	62,5	0,0	0,0	0,2	DC..11T3..
SDNCN2020K11	00092197	20	20	125	10,2	22,0	62,5	0,0	0,0	0,4	DC..11T3..
SDNCN2525M11	00092198	25	25	150	12,7	23,0	62,5	0,0	0,0	0,7	DC..11T3..
SDNCN2020K15	75011885	20	20	125	10,2	29,0	62,5	0,0	0,0	0,4	DC..1504..

Spare Parts

For size	Insert key	Insert screw	Insert shim	Shim screw
...07	T07P-2	C02506-T07P	-	-
.12/14/16..11	T15P-2	C04008-T15P	-	-
.20/25..11	T15P-2	C03510-T15P	126.19-620	CA3510
...15	T15P-2	C04512-T15P	126.19-621	CA4508

Accessories

For size	Insert clamping torque	Replacement blade	Shim key	Torque key
...07	0.9NM	T00-07P	-	T00-07P09
.12/14/16..11	3.5NM	T00-15P	-	T00-15P35
.20/25..11	3.0NM	T00-15P	9/64SMS875	T00-15P30
...15	5.0NM	T00-15P	5SMS795	T00-15P50

SDPCN – Toolholders for inserts DCGT, DCGW, DCMT and DCMW – Inch

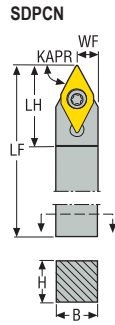
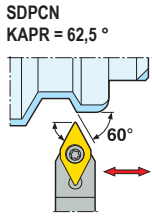

- For inserts program, see page(s) 534, 535, 536, 578, 600
- GAMO° = Rake angle, LAMS° = Inclination angle
- CTWS = Insert shape and size
- For holder code key, see page(s) 17-18
- Right-hand version shown
- Please check availability at www.secotools.com / Seco Online Store

Designation	Item number	H	B	LF	WF	LH	KAPR°	GAMO°	LAMS°	Weight	CTWS
		Inch	Inch	Inch	Inch	Inch				lbs	
SDPCN-16-3	00073942	1.000	1.000	5.996	0.500	0.860	62,5	0,0	0,0	1.760	DC..32.5.

Spare Parts

For size	Insert key	Insert screw
..-3	T15P-2	C04008-T15P

Accessories

For size	Insert clamping torque	Replacement blade	Torque key
..-3	31.0IN.LBS	T00-15P	T00-15P35

General ISO Turning Holders
Steadyline®
MDT
Mini-Shaft™
Grooving
Parting-off
X4
Adapters Clamping units
Accessories and Spare parts
Workpiece materials

SRDCN – Toolholders for inserts RCMT – Metric

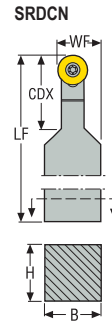

SRDCN
KAPR = 45,0 °

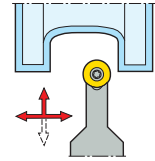















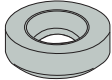

CTWS

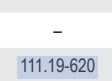

- For inserts program, see page(s) 545, 546
- GAMO° = Rake angle, LAMS° = Inclination angle
- CTWS = Insert shape and size
- For holder code key, see page(s) 15-16
- Neutral version shown
- Please check availability at www.secotools.com / Seco Online Store

Designation	Item number	H	B	LF	WF	CDX	KAPR°	GAMO°	LAMS°	Weight	CTWS
		mm	mm	mm	mm	mm				kg	
SRDCN1616H06	75011837	16	16	100	11,0	16,0	45,0	0,0	0,0	0,2	RCMT0602..
SRDCN2020K06	75011838	20	20	125	13,0	16,0	45,0	0,0	0,0	0,4	RCMT0602..
SRDCN2525M06	75011839	25	25	150	15,5	16,0	45,0	0,0	0,0	0,7	RCMT0602..
SRDCN1616H08	75011840	16	16	100	12,0	16,0	45,0	0,0	0,0	0,2	RCMT0803..
SRDCN2020K08	75011841	20	20	125	14,0	20,0	45,0	0,0	0,0	0,4	RCMT0803..
SRDCN2525M08	75011706	25	25	150	16,5	25,0	45,0	0,0	0,0	0,7	RCMT0803..
SRDCN2020K10	75011842	20	20	125	15,0	20,0	45,0	0,0	0,0	0,4	RCMT10T3..
SRDCN2525M10	75011843	25	25	150	17,5	25,0	45,0	0,0	0,0	0,7	RCMT10T3..
SRDCN2525M12	75011844	25	25	150	18,5	25,0	45,0	0,0	0,0	0,7	RCMT1204..
SRDCN3225P12	75011845	32	25	170	18,5	32,0	45,0	0,0	0,0	1,0	RCMT1204..
SRDCN3225P16	75011846	32	25	170	20,5	32,0	45,0	0,0	0,0	1,0	RCMT1606..

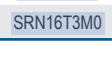
Spare Parts

For size	Insert key	Insert screw	Insert shim	Shim screw
...06	 T07P-2	 C02506-T07P	-	-
...08	 T09P-2	 C03007-T09P	-	-
...10	 T15P-2	 C03510-T15P	 111.19-620	 CA3510
...12	 T15P-2	 C03512-T15P	 111.19-621	 CA3510
...16	 T20P-7L	 C05018-T20P	 SRN16T3M0	 CA5015

Accessories

For size	Insert clamping torque	Replacement blade	Shim key	Torque key
...06	0.9NM	T00-07P	-	T00-07P09
...08	2.0NM	T00-09P	-	T00-09P20
...10	3.0NM	T00-15P	9/64SMS875	T00-15P30
...12	3.0NM	T00-15P	9/64SMS875	T00-15P30
...16	5.0NM	T00-20P	5SMS795	T00-20P50

General ISO Turning Holders

Steadyline®

MDT

Mini-Shaft™

Grooving

Parting-off

X4

Adapters Clamping units

Accessories and Spare parts

Workpiece materials

SRDCN – Toolholders for inserts RCMT – Inch

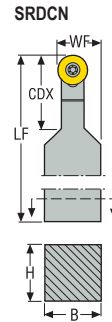

SRDCN
KAPR = 90,0 °

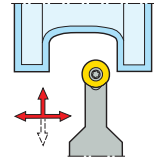













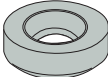



CTWS













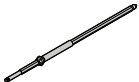

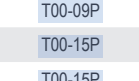

- For inserts program, see page(s) 545, 546
- GAMO° = Rake angle, LAMS° = Inclination angle
- CTWS = Insert shape and size
- For holder code key, see page(s) 17-18
- Neutral version shown
- Please check availability at www.secotools.com / Seco Online Store

Designation	Item number	H	B	LF	CDX	KAPR°	GAMO°	LAMS°	Weight	CTWS
		Inch	Inch	Inch	Inch				lbs	
SRDCN-10-06	00071932	0.625	0.625	4.000	0.630	90,0	0,0	0,0	0.660	RCMT0602..
SRDCN-12-08	00057603	0.750	0.750	5.000	0.787	90,0	0,0	0,0	0.660	RCMT0803..
SRDCN-12-10	00071935	0.750	0.750	5.000	0.787	90,0	0,0	0,0	0.880	RC..10T3..
SRDCN-16-12	00071928	1.000	1.000	7.000	0.984	90,0	0,0	0,0	1.980	RCMM43
SRDCN-85-12	00071953	1.250	1.000	7.000	0.984	90,0	0,0	0,0	2.430	RCMM43

Spare Parts

For size	Insert key	Insert screw	Insert shim	Shim screw
..-06	 T07P-2	 C02506-T07P	 111.19-620	 CA3510
..-08	 T09P-2	 C03007-T09P	 111.19-621	 CA3510
..-10	 T15P-2	 C03510-T15P	 111.19-620	 CA3510
..-12	 T15P-2	 C03510-T15P	 111.19-621	 CA3510

Accessories

For size	Insert clamping torque	Replacement blade	Shim key	Torque key
..-06	 8.0IN.LBS	 T00-07P	 -	 T00-07P09
..-08	 17.7IN.LBS	 T00-09P	 -	 T00-09P20
..-10	 26.6IN.LBS	 T00-15P	 5SMS795	 T00-15P30
..-12	 26.6IN.LBS	 T00-15P	 9/64SMS875	 T00-15P30

SRGCR/L – Toolholders for inserts RCMT – Inch

SRGCR/L
KAPR = 45,0°

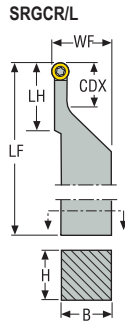
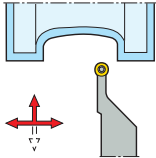

CTWS



- For inserts program, see page(s) 545, 546
- GAMO° = Rake angle, LAMS° = Inclination angle
- CTWS = Insert shape and size
- For holder code key, see page(s) 17-18
- Neutral version shown
- Please check availability at www.secotools.com / Seco Online Store

Designation	Item number	H	B	LF	LH	CDX	KAPR°	GAMO°	LAMS°	Weight	CTWS
		Inch	Inch	Inch	Inch	Inch				lbs	
SRGCR-12-2	00013346	0.750	0.750	4.500	1.480	0.730	45,0	0,0	0,0	1.540	RCMT22.
SRGCR-16-2	00013351	1.000	1.000	6.000	1.480	0.730	45,0	0,0	0,0	1.540	RCMT22.
SRGCL-16-2	00013352	1.000	1.000	6.000	1.480	0.730	45,0	0,0	0,0	1.540	RCMT22.
SRGCL-20-2	00013357	1.250	1.250	6.024	1.480	0.730	45,0	0,0	0,0	1.980	RCMT0803..
SRGCR-12-3	00013348	0.750	0.750	4.500	1.730	0.980	45,0	0,0	0,0	0.660	RCMT32.5
SRGCR-16-3	00013353	1.000	1.000	6.000	1.730	0.980	45,0	0,0	0,0	1.540	RCMT32.5
SRGCR-20-3	00013358	1.250	1.250	6.000	1.730	0.980	45,0	0,0	0,0	2.200	RCMT32.5
SRGCL-12-3	00013349	0.750	0.750	4.500	1.730	0.945	45,0	0,0	0,0	0.880	RCMT32.5
SRGCL-16-3	00013354	1.000	1.000	6.000	1.730	0.980	45,0	0,0	0,0	1.540	RCMT32.5
SRGCL-20-3	00013359	1.250	1.250	6.000	1.730	0.980	45,0	0,0	0,0	2.200	RCMT32.5
SRGCR-20-4	00013361	1.250	1.250	6.000	1.720	0.970	45,0	0,0	0,0	2.430	RCMM43
SRGCL-20-4	00013362	1.250	1.250	6.000	1.720	0.945	45,0	0,0	0,0	2.430	RCMM43

Spare Parts

For size	Insert key	Insert screw	Insert shim	Shim screw
..-2	 T07P-2	 C02506-T07P	 -	 -
..-3	TX-3.5	C03508-T15P	RS-32C	SLS-35
..-4	T15P-2	C04011-T15P	RS-43C	SLS-40

Accessories

For size	Insert clamping torque	Replacement blade	Torque key
..-2	 8.0IN.LBS	 T00-07P	 T00-07P09
..-3	26.6IN.LBS	T00-15P	T00-15P30
..-4	31.0IN.LBS	T00-15P	T00-15P35

SRSCR/L – Toolholders for inserts RCMT – Metric

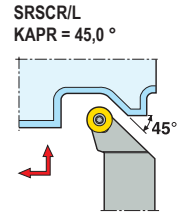
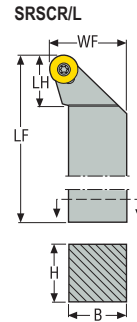

CTWS





- For inserts program, see page(s) 545, 546
- GAMO° = Rake angle, LAMS° = Inclination angle
- CTWS = Insert shape and size
- For holder code key, see page(s) 15-16
- Right-hand version shown
- Please check availability at www.secotools.com / Seco Online Store

Designation	Item number	H	B	LF	WF	LH	KAPR°	GAMO°	LAMS°	Weight	CTWS
		mm	mm	mm	mm	mm				kg	
SRSCR2020K06	00092191	20	20	125	25,0	15,0	45,0	0,0	0,0	0,4	RCMT0602..
SRSCR2525M06	75011823	25	25	150	32,0	15,0	45,0	0,0	0,0	0,7	RCMT0602..
SRSCCL2020K06	00092192	20	20	125	25,0	15,0	45,0	0,0	0,0	0,4	RCMT0602..
SRSCCL2525M06	75011824	25	25	150	32,0	15,0	45,0	0,0	0,0	0,7	RCMT0602..
SRSCR2020K08	75011827	20	20	125	25,0	25,0	45,0	0,0	0,0	0,4	RCMT0803..
SRSCR2525M08	75011704	25	25	150	32,0	25,0	45,0	0,0	0,0	0,7	RCMT0803..
SRSCCL2525M08	75011705	25	25	150	32,0	25,0	45,0	0,0	0,0	0,7	RCMT0803..
SRSCR2020K10	75011829	20	20	125	25,0	17,0	45,0	0,0	0,0	0,4	RCMT10T3..
SRSCR2525M10	75011933	25	25	150	32,0	20,0	45,0	0,0	0,0	0,7	RCMT10T3..
SRSCCL2020K10	75011830	20	20	125	25,0	17,0	45,0	0,0	0,0	0,4	RCMT10T3..
SRSCCL2525M10	75011934	25	25	150	32,0	20,0	45,0	0,0	0,0	0,7	RCMT10T3..
SRSCR2525M12	75011831	25	25	150	32,0	23,0	45,0	0,0	0,0	0,7	RCMT1204..
SRSCR3225P12	75011833	32	25	170	32,0	23,0	45,0	0,0	0,0	1,1	RCMT1204..
SRSCCL2525M12	75011832	25	25	150	32,0	23,0	45,0	0,0	0,0	0,7	RCMT1204..
SRSCCL3225P12	75011834	32	25	170	32,0	23,0	45,0	0,0	0,0	1,1	RCMT1204..
SRSCR3225P16	75011835	32	25	170	32,0	25,0	45,0	0,0	0,0	1,1	RCMT1606..
SRSCCL3225P16	75011836	32	25	170	32,0	25,0	45,0	0,0	0,0	1,1	RCMT1606..

Spare Parts

For size	Insert key	Insert screw	Insert shim	Shim screw
...06	T07P-2	C02506-T07P	-	-
...08	T09P-2	C03007-T09P	-	-
...10	T15P-2	C03510-T15P	111.19-620	CA3510
...12	T15P-2	C03512-T15P	111.19-621	CA3510
...16	T20P-7L	C05018-T20P	SRN16T3M0	CA5015

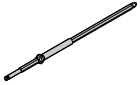
Accessories

For size	Insert clamping torque 	Replacement blade 	Shim key 	Torque key 
...06	0.9NM	T00-07P	-	T00-07P09
...08	2.0NM	T00-09P	-	T00-09P20
...10	3.0NM	T00-15P	9/64SMS875	T00-15P30
...12	3.0NM	T00-15P	9/64SMS875	T00-15P30
...16	5.0NM	T00-20P	5SMS795	T00-20P50

- General ISO Turning Holders
- Steadyline®
- MDT
- Mini-Shaft™
- Grooving
- Parting-off
- X4
- Adapters Clamping units
- Accessories and Spare parts
- Workpiece materials

SSDCN – Toolholders for inserts SCGW, SCMT and SCMW – Metric

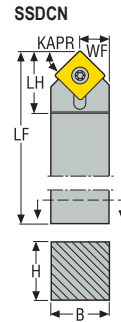

SSDCN
KAPR = 45,0 °

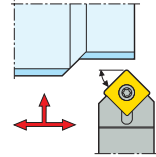

CTWS



- For inserts program, see page(s) 548, 549, 584
- GAMO° = Rake angle, LAMS° = Inclination angle
- CTWS = Insert shape and size
- For holder code key, see page(s) 15-16
- Neutral version shown
- Please check availability at www.secotools.com / Seco Online Store

Designation	Item number	H	B	LF	WF	LH	KAPR°	GAMO°	LAMS°	Weight	CTWS
		mm	mm	mm	mm	mm				kg	
SSDCN1212M09	00089909	12	12	150	6,2	23,0	45,0	0,0	0,0	0,2	SC..09T3..
SSDCN1616H09	75011882	16	16	100	8,2	26,0	45,0	0,0	0,0	0,2	SC..09T3..
SSDCN2020K09	00092193	20	20	125	10,2	22,0	45,0	0,0	0,0	0,4	SC..09T3..
SSDCN2525M09	00092194	25	25	150	12,7	23,0	45,0	0,0	0,0	0,8	SC..09T3..
SSDCN2020K12	75011883	20	20	125	10,2	22,0	45,0	0,0	0,0	0,4	SC..1204..
SSDCN2525M12	75011884	25	25	150	12,7	22,0	45,0	0,0	0,0	0,8	SC..1204..

Spare Parts

For size	Insert key	Insert screw	Insert shim	Shim screw
...09	T15P-2	C04008-T15P	-	-
...K12	T15P-2	C05012-T15P	110.19-621	CA5008
...M12	T20P-7L	C05018-T20P	110.19-621	CA5015

Accessories

For size	Insert clamping torque	Replacement blade	Shim key	Torque key
...09	3.5NM	T00-15P	-	T00-15P35
...K12	5.0NM	T00-15P	5SMS795	T00-15P50
...M12	5.0NM	T00-20P	5SMS795	T00-20P50

SSDCN – Toolholders for inserts SCGW, SCMT and SCMW – Inch

SSDCN
KAPR = 45,0°

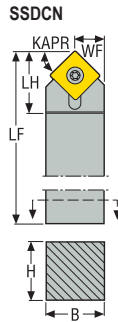
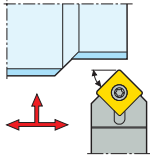

CTWS



- For inserts program, see page(s) 548, 549, 584
- GAMO° = Rake angle, LAMS° = Inclination angle
- CTWS = Insert shape and size
- For holder code key, see page(s) 17-18
- Neutral version shown
- Please check availability at www.secotools.com / Seco Online Store

Designation	Item number	H	B	LF	WF	LH	KAPR°	GAMO°	LAMS°	Weight	CTWS
		Inch	Inch	Inch	Inch	Inch				lbs	
SSDCN-8-3	00043262	0.500	0.500	3.500	0.250	0.630	45,0	0,0	0,0	0.440	SC..32.5.
SSDCN-10-3	00043259	0.625	0.625	4.000	0.312	0.630	45,0	0,0	0,0	0.220	SC..32.5.
SSDCN-12-4	00043260	0.750	0.750	4.500	0.375	0.810	45,0	0,0	0,0	0.880	SC..43.

Spare Parts

For size	Insert key	Insert screw	Insert shim	Shim screw
..-3	 T15P-2	 C04008-T15P	 -	 -
..-4	 T15P-2	 C05012-T15P	 110.19-621	 CA5008

Accessories

For size	Insert clamping torque	Replacement blade	Shim key	Torque key
..-3	 31.0IN.LBS	 T00-15P	 -	 T00-15P35
..-4	 44.3IN.LBS	 T00-15P	 5SMS795	 T00-15P50

General ISO Turning
Holders

Steadyline®

MDT

Mini-Shaft™

Grooving

Parting-off

X4

Adapters
Clamping units

Accessories and
Spare parts

Workpiece
materials

SSBCR/L – Toolholders for inserts SCMT – Metric

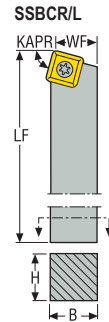

SSBCR/L
KAPR = 75,0 °

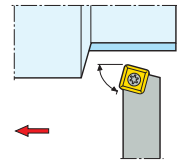

CTWS



- For inserts program, see page(s) 548, 549
- GAMO° = Rake angle, LAMS° = Inclination angle
- CTWS = Insert shape and size
- For holder code key, see page(s) 15-16
- Right-hand version shown
- Please check availability at www.secotools.com / Seco Online Store

Designation	Item number	H	B	LF	WF	LH	KAPR°	GAMO°	LAMS°	Weight	CTWS
		mm	mm	mm	mm	mm				kg	
SSBCR5050T38	02785005	50	50	300	43,0	0,0	75,0	0,0	0,0	5,6	SC..3809..
SSBCR6060V38	02773272	60	60	400	53,0	0,0	75,0	0,0	0,0	10,9	SC..3809..

Spare Parts

For size	Insert key	Insert screw	Insert shim	Shim screw
...38	T30P-7	C08020-T30P	112.19-624	CA8020

Accessories

For size	Insert clamping torque	Replacement blade	Shim key	Torque key
...38	8.0NM	T00T-30P	5SMS795	T00T-30P80

General ISO Turning Holders
Steadyline®
MDT
Mini-Shaft™
Grooving
Parting-off
X4
Adapters Clamping units
Accessories and Spare parts
Workpiece materials

STGCR/L and STFCL/L – Toolholders for inserts TCGT, TCGW, TCMT and TCMW – Metric

STGCR/L
KAPR = 90,0°

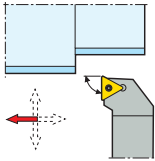



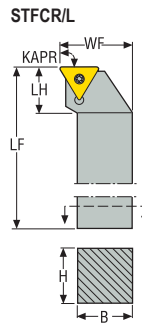
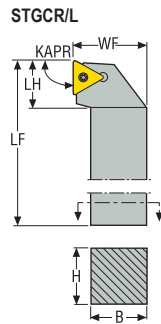
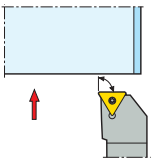



STFCR/L
KAPR = 90,0°



- For inserts program, see page(s) 555, 556, 589, 601
- GAMO° = Rake angle, LAMS° = Inclination angle
- CTWS = Insert shape and size
- For holder code key, see page(s) 15-16
- Right-hand version shown
- Please check availability at www.secotools.com / Seco Online Store

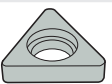

Designation	Item number	H	B	LF	WF	LH	KAPR°	GAMO°	LAMS°	Weight	CTWS
		mm	mm	mm	mm	mm				kg	
STGCR1212F11	75066181	12	12	80	16,0	17,0	90,0	0,0	0,0	0,1	TC..1102..
STGCR1616H11	75066183	16	16	100	20,0	17,0	90,0	0,0	0,0	0,2	TC..1102..
STGCL1212F11	75066182	12	12	80	16,0	17,0	90,0	0,0	0,0	0,1	TC..1102..
STGCL1616H11	75066184	16	16	100	20,0	17,0	90,0	0,0	0,0	0,2	TC..1102..
STGCR1616H16	75066197	16	16	100	20,0	25,0	90,0	0,0	0,0	0,2	TC..16T3..
STGCR2020K16	75066199	20	20	125	25,0	26,0	90,0	0,0	0,0	0,4	TC..16T3..
STGCR2525M16	75066201	25	25	150	32,0	27,0	90,0	0,0	0,0	0,8	TC..16T3..
STGCL1616H16	75066198	16	16	100	20,0	25,0	90,0	0,0	0,0	0,2	TC..16T3..
STGCL2020K16	75066200	20	20	125	25,0	26,0	90,0	0,0	0,0	0,4	TC..16T3..
STGCL2525M16	75066203	25	25	150	32,0	27,0	90,0	0,0	0,0	0,8	TC..16T3..
STFCR1212F11	75054888	12	12	80	16,0	16,0	90,0	0,0	0,0	0,1	TC..1102..
STFCR1616H11	75028230	16	16	100	20,0	16,0	90,0	0,0	0,0	0,2	TC..1102..
STFCL1212F11	75066245	12	12	80	16,0	16,0	90,0	0,0	0,0	0,1	TC..1102..
STFCL1616H11	75034423	16	16	100	20,0	16,0	90,0	0,0	0,0	0,2	TC..1102..
STFCR1616H16	75066191	16	16	100	20,0	22,0	90,0	0,0	0,0	0,3	TC..16T3..
STFCR2020K16	75066193	20	20	125	25,0	22,0	90,0	0,0	0,0	0,4	TC..16T3..
STFCR2525M16	75066195	25	25	150	32,0	24,0	90,0	0,0	0,0	0,8	TC..16T3..
STFCL1616H16	75066192	16	16	100	20,0	22,0	90,0	0,0	0,0	0,3	TC..16T3..
STFCL2020K16	75066194	20	20	125	25,0	22,0	90,0	0,0	0,0	0,4	TC..16T3..
STFCL2525M16	75066196	25	25	150	32,0	24,0	90,0	0,0	0,0	0,8	TC..16T3..

Spare Parts

For size	Insert key	Insert screw	Insert shim	Shim screw
...11	 T07P-2	 C02506-T07P	-	-
...16	 T15P-2	 C03509-T15P	 STN160312	 CA3510

General ISO Turning Holders
Steadyline®
MDT
Mini-Shaft™
Grooving
Parting-off
X4
Adapters Clamping units
Accessories and Spare parts
Workpiece materials

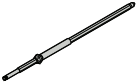
Accessories

For size	Insert clamping torque	Replacement blade	Shim key	Torque key
...11	0.9NM 	T00-07P 	- 	T00-07P09 
...16	3.0NM	T00-15P	9/64SMS875	T00-15P30

General ISO Turning
Holders

Steadyline®

MDT

Mini-Shaft™

Grooving

Parting-off

X4

Adapters
Clamping units

Accessories and
Spare parts

Workpiece
materials

STGCR/L – Toolholders for inserts TCGT, TCGW, TCMT and TCMW – Inch



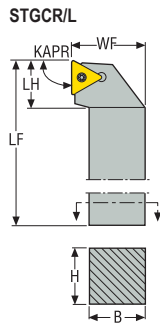
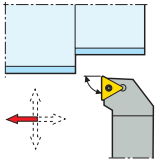

STGCR/L
KAPR = 90,0°









- For inserts program, see page(s) 555, 556, 589, 601
- GAMO° = Rake angle, LAMS° = Inclination angle
- CTWS = Insert shape and size
- For holder code key, see page(s) 17-18
- Right-hand version shown
- Please check availability at www.secotools.com / Seco Online Store

Designation	Item number	H	B	LF	WF	LH	KAPR°	GAMO°	LAMS°	Weight	CTWS
		Inch	Inch	Inch	Inch	Inch				lbs	
STGCR-6-2	00013373	0.375	0.375	2.500	0.500	0.600	90,0	0,0	0,0	0.220	TC..21.5.
STGCR-8-2	00013376	0.500	0.500	3.500	0.625	0.620	90,0	0,0	0,0	0.440	TC..21.5.
STGCL-6-2	00013374	0.375	0.375	2.500	0.500	0.600	90,0	0,0	0,0	0.220	TC..21.5.
STGCL-8-2	00013377	0.500	0.500	3.500	0.625	0.620	90,0	0,0	0,0	0.440	TC..21.5.
STGCR-10-3	00013378	0.625	0.625	4.000	0.750	0.850	90,0	0,0	0,0	0.660	TC..32.5.
STGCL-10-3	00013379	0.625	0.625	4.000	0.750	0.850	90,0	0,0	0,0	0.660	TC..32.5.

Spare Parts

For size	Insert key	Insert screw
..-2	 T07P-2	 C02506-T07P
..-3	 T15P-2	 C04008-T15P

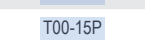
Accessories

For size	Insert clamping torque	Replacement blade	Torque key
..-2	 8.0IN.LBS	 T00-07P	 T00-07P09
..-3	 31.0IN.LBS	 T00-15P	 T00-15P35

General ISO Turning Holders
Steadyline®
MDT
Mini-Shaft™
Grooving
Parting-off
X4
Adapters Clamping units
Accessories and Spare parts
Workpiece materials

STJCR/L – Toolholders for inserts TCGT, TCGW, TCMT and TCMW – Metric

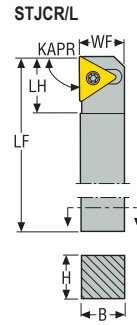

STJCR/L
KAPR = 93,0 °

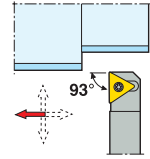

CTWS



- For inserts program, see page(s) 555, 556, 589, 601
- GAMO° = Rake angle, LAMS° = Inclination angle
- CTWS = Insert shape and size
- For holder code key, see page(s) 15-16
- Right-hand version shown
- Please check availability at www.secotools.com / Seco Online Store

Designation	Item number	H	B	LF	WF	LH	KAPR°	GAMO°	LAMS°	Weight	CTWS
		mm	mm	mm	mm	mm				kg	
STJCR1010M11	02430911	10	10	150	10,0	13,0	93,0	0,0	0,0	0,2	TC..1102..
STJCR1212M11	02430917	12	12	150	12,0	13,0	93,0	0,0	0,0	0,2	TC..1102..
STJCR1616H11	02430921	16	16	100	16,0	13,0	93,0	0,0	0,0	0,2	TC..1102..
STJCL1010M11	02430914	10	10	150	10,0	13,0	93,0	0,0	0,0	0,2	TC..1102..
STJCL1212M11	02430920	12	12	150	12,0	13,0	93,0	0,0	0,0	0,2	TC..1102..
STJCL1616H11	02430932	16	16	100	16,0	13,0	93,0	0,0	0,0	0,2	TC..1102..

Spare Parts

For size	Insert key	Insert screw
...11	 T07P-2	 C02506-T07P

Accessories

For size	Insert clamping torque	Replacement blade	Torque key
...11	 0.9NM	 T00-07P	 T00-07P09

SVJBR/L – Toolholders for inserts VBGT, VBGW, VBMT, VBMT and VCGT – Metric

SVJBR/L
KAPR = 93,0°

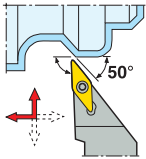

SVJBR/L

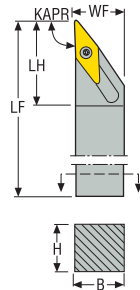

SVJBR/L..H11, ..K11,
..25M11

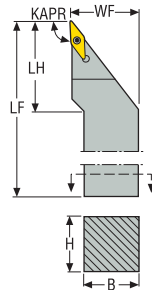

- For inserts program, see page(s) 563, 564, 564, 594, 602
- GAMO° = Rake angle, LAMS° = Inclination angle
- CTWS = Insert shape and size
- For holder code key, see page(s) 15-16
- Right-hand version shown
- Please check availability at www.secotools.com / Seco Online Store

Designation	Item number	H	B	LF	WF	LH	KAPR°	GAMO°	LAMS°	Weight	CTWS
		mm	mm	mm	mm	mm				kg	
SVJBR1010M11	02431006	10	10	150	10,0	20,0	93,0	0,0	0,0	0,2	VB..1102..
SVJBR1212M11	02439655	12	12	150	12,0	20,0	93,0	0,0	0,0	0,2	VB..1102..
SVJBR1616H11	75066240	16	16	100	20,0	27,0	93,0	0,0	0,0	0,2	VB..1102..
SVJBR2020K11	75066241	20	20	125	25,0	27,0	93,0	0,0	0,0	0,4	VB..1102..
SVJBR2525M11	75077182	25	25	150	32,0	42,0	93,0	0,0	0,0	0,7	VB..1102..
SVJBL1010M11	02431007	10	10	150	10,0	20,0	93,0	0,0	0,0	0,2	VB..1102..
SVJBL1212M11	02439658	12	12	150	12,0	20,0	93,0	0,0	0,0	0,2	VB..1102..
SVJBL1616H11	75065783	16	16	100	20,0	27,0	93,0	0,0	0,0	0,2	VB..1102..
SVJBL2020K11	75027877	20	20	125	25,0	27,0	93,0	0,0	0,0	0,4	VB..1102..
SVJBL2525M11	75077183	25	25	150	32,0	42,0	93,0	0,0	0,0	0,7	VB..1102..
SVJBR1212M16	02431016	12	12	150	12,5	30,0	93,0	0,0	0,0	0,2	VB../VC..1604..
SVJBR1616H16	02431021	16	16	100	16,5	30,0	93,0	0,0	0,0	0,2	VB../VC..1604..
SVJBL1212M16	02431020	12	12	150	12,0	30,0	93,0	0,0	0,0	0,2	VB../VC..1604..
SVJBL1616H16	02431024	16	16	100	16,0	30,0	93,0	0,0	0,0	0,2	VB../VC..1604..

Spare Parts

For size	Insert key	Insert screw
...11	T07P-2	C02506-T07P
...16	T15P-2	C03512-T15P

Accessories

For size	Insert clamping torque	Replacement blade	Torque key
...11	0.9NM	T00-07P	T00-07P09
...16	3.0NM	T00-15P	T00-15P30

General ISO Turning Holders
Steadyline®
MDT
Mini-Shaft™
Grooving
Parting-off
X4
Adapters Clamping units
Accessories and Spare parts
Workpiece materials

SVJCR/L and SVABR/L – Toolholders for inserts VBGT, VBGW, VBMT, VBWM and VCGT – Metric

General ISO Turning Holders
Steadyline®
MDT
Mini-Shaft™
Grooving
Parting-off
X4
Adapters and Clamping units
Accessories and Spare parts
Workpiece materials

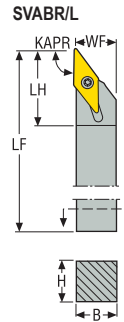
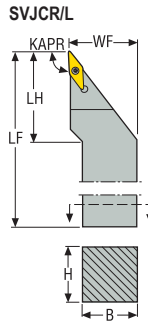

SVJCR/L
KAPR = 93,0 °

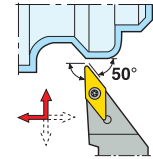



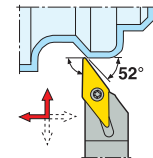

SVABR/L
KAPR = 90,0 °





- For inserts program, see page(s) 563, 564, 564, 594, 602
- GAMO° = Rake angle, LAMS° = Inclination angle
- CTWS = Insert shape and size
- For holder code key, see page(s) 15-16
- Right-hand version shown
- Please check availability at www.secotools.com / Seco Online Store

Designation	Item number	H	B	LF	WF	LH	KAPR°	GAMO°	LAMS°	Weight	CTWS
		mm	mm	mm	mm	mm				kg	
SVJCR2020K11	02416717	20	20	125	25,0	25,0	93,0	0,0	0,0	0,4	VC..1103..
SVJCL2020K11	02416718	20	20	125	25,0	25,0	93,0	0,0	0,0	0,4	VC..1103..
SVABR1010M11	02430935	10	10	150	10,0	20,0	90,0	0,0	0,0	0,2	VB..1102..
SVABR1212M11	02430954	12	12	150	12,0	20,0	90,0	0,0	0,0	0,2	VB..1102..
SVABL1010M11	02430948	10	10	150	10,0	20,0	90,0	0,0	0,0	0,2	VB..1102..
SVABL1212M11	02430956	12	12	150	12,0	20,0	90,0	0,0	0,0	0,2	VB..1102..
SVABR1212M16	02431000	12	12	150	12,0	30,0	90,0	0,0	0,0	0,2	VB../VC..1604..
SVABR1616H16	02431002	16	16	100	16,0	30,0	90,0	0,0	0,0	0,2	VB../VC..1604..
SVABL1212M16	02431001	12	12	150	12,0	30,0	90,0	0,0	0,0	0,2	VB../VC..1604..
SVABL1616H16	02431003	16	16	100	16,0	30,0	90,0	0,0	0,0	0,2	VB../VC..1604..

Spare Parts

For size	Insert key	Insert screw
...11	 T07P-2	 C02506-T07P
...16	 T15P-2	 C03510-T15P

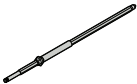
Accessories

For size	Insert clamping torque	Replacement blade	Torque key
...11	 0.9NM	 T00-07P	 T00-07P09
...16	3.0NM	T00-15P	T00-15P30

SVLBR/L – Toolholders for inserts VBGT, VBGW, VBMT, VBMT and VCGT – Metric

SVLBR/L
KAPR = 95,0°

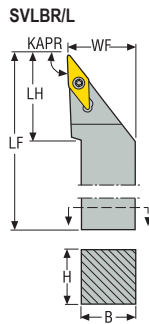
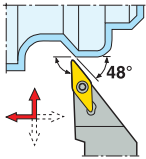





CTWS





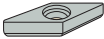

- For inserts program, see page(s) 563, 564, 564, 594, 602
- GAMO° = Rake angle, LAMS° = Inclination angle
- CTWS = Insert shape and size
- For holder code key, see page(s) 15-16
- Right-hand version shown
- Please check availability at www.secotools.com / Seco Online Store

Designation	Item number	H	B	LF	WF	LH	KAPR°	GAMO°	LAMS°	Weight	CTWS
		mm	mm	mm	mm	mm				kg	
SVLBR2020K16	75011715	20	20	125	25,0	40,0	95,0	0,0	0,0	0,4	VB../VC../1604..
SVLBR2525M16	75011717	25	25	150	32,0	40,0	95,0	0,0	0,0	0,7	VB../VC../1604..
SVLBR3225P16	75011719	32	25	170	32,0	40,0	95,0	0,0	0,0	1,0	VB../VC../1604..
SVLBL2020K16	75011716	20	20	125	25,0	40,0	95,0	0,0	0,0	0,4	VB../VC../1604..
SVLBL2525M16	75011718	25	25	150	32,0	40,0	95,0	0,0	0,0	0,7	VB../VC../1604..
SVLBL3225P16	75011720	32	25	170	32,0	40,0	95,0	0,0	0,0	1,0	VB../VC../1604..

Spare Parts

For size	Insert key	Insert screw	Insert shim	Shim screw
...16	 T15P-2	 C03512-T15P	 171.19-620	 CA3510

Accessories

For size	Insert clamping torque	Replacement blade	Shim key	Torque key
...16	 3.0NM	 T00-15P	 9/64SMS875	 T00-15P30

SVLBR/L and SVVBN – Toolholders for inserts VBGT, VBGM and VBMT – Inch

General ISO Turning Holders
Steadyline®
MDT
Mini-Shaft™
Grooving
Parting-off
X4
Adapters Clamping units
Accessories and Spare parts
Workpiece materials

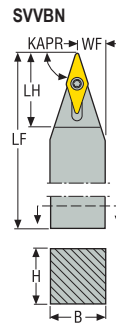
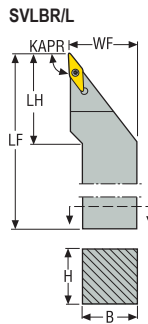

SVLBR/L
KAPR = 95,0 °

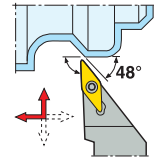

SVVBN
KAPR = 72,5 °

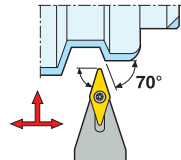





- For inserts program, see page(s) 563, 564
- GAMO° = Rake angle, LAMS° = Inclination angle
- CTWS = Insert shape and size
- For holder code key, see page(s) 17-18
- Right-hand version shown
- Please check availability at www.secotools.com / Seco Online Store

Designation	Item number	H	B	LF	WF	LH	KAPR°	GAMO°	LAMS°	Weight	CTWS
		Inch	Inch	Inch	Inch	Inch				lbs	
SVLBR-12-3	00071930	0.750	0.750	4.500	0.875	1.180	95,0	0,0	0,0	0.880	VB..33.
SVLBR-16-3	00071929	1.000	1.000	6.000	1.125	1.180	95,0	0,0	0,0	1.760	VB..33.
SVLBR-12-3	00071944	0.750	0.750	4.500	0.875	1.180	95,0	0,0	0,0	0.660	VB..33.
SVLBR-16-3	00071950	1.000	1.000	6.000	1.125	1.180	95,0	0,0	0,0	1.540	VB..33.
SVVBN-12-3	00071940	0.750	0.750	4.500	0.375	1.390	72,5	0,0	0,0	0.880	VB..33.
SVVBN-16-3	00071946	1.000	1.000	6.000	0.500	1.394	72,5	0,0	0,0	1.760	VB..33.

Spare Parts

For size	Insert key	Insert screw	Insert shim	Shim screw
...3	 T15P-2	 C03510-T15P	 171.19-620	 CA3510

Accessories

For size	Insert clamping torque	Replacement blade	Shim key	Torque key
...3	 26.6IN.LBS	 T00-15P	 9/64SMS875	 T00-15P30

SVVBN – Toolholders for inserts VBGT, VBGW, VBMT, VBMT and VCGT – Metric

SVVBN
KAPR = 72,5°

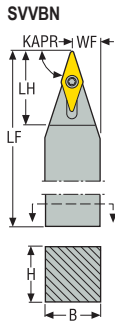
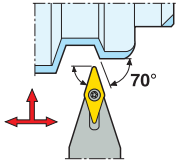

CTWS



- For inserts program, see page(s) 563, 564, 564, 594, 602
- GAMO° = Rake angle, LAMS° = Inclination angle
- CTWS = Insert shape and size
- For holder code key, see page(s) 15-16
- Neutral version shown
- Please check availability at www.secotools.com / Seco Online Store

Designation	Item number	H	B	LF	WF	LH	KAPR°	GAMO°	LAMS°	Weight	CTWS
		mm	mm	mm	mm	mm				kg	
SVVBN1010M11	02431026	10	10	150	5,3	25,0	72,5	0,0	0,0	0,2	VB..1102..
SVVBN1212M11	02439659	12	12	150	6,3	25,0	72,5	0,0	0,0	0,2	VB..1102..
SVVBN1616H11	75077179	16	16	100	8,3	26,0	72,5	0,0	0,0	0,2	VB..1102..
SVVBN2020K11	75077180	20	20	125	10,3	26,0	72,5	0,0	0,0	0,4	VB..1102..
SVVBN2525M11	75077181	25	25	150	12,8	26,0	72,5	0,0	0,0	0,7	VB..1102..
SVVBN1212M16	02431027	12	12	150	6,3	30,0	72,5	0,0	0,0	0,2	VB..VC..1604..
SVVBN1616H16	02431029	16	16	100	8,3	30,0	72,5	0,0	0,0	0,2	VB..VC..1604..
SVVBN2020K16	75011514	20	20	125	10,6	35,0	72,5	0,0	0,0	0,4	VB..VC..1604..
SVVBN2525M16	75011515	25	25	150	13,1	35,0	72,5	0,0	0,0	0,7	VB..VC..1604..
SVVBN3225P16	75011516	32	25	170	13,1	35,0	72,5	0,0	0,0	1,0	VB..VC..1604..

Spare Parts

For size	Insert key	Insert screw	Insert shim	Shim screw
...11	T07P-2	C02506-T07P	-	-
.1212M16	T15P-2	C03510-T15P	-	-
.1616H16	T15P-2	C03510-T15P	-	-
...16	T15P-2	C03512-T15P	171.19-620	CA3510

Accessories

For size	Insert clamping torque	Replacement blade	Shim key	Torque key
...11	0.9NM	T00-07P	-	T00-07P09
.1212M16	3.0NM	T00-15P	-	T00-15P30
.1616H16	3.0NM	T00-15P	-	T00-15P30
...16	3.0NM	T00-15P	9/64SMS875	T00-15P30

General ISO Turning Holders
Steadyline®
MDT
Mini-Shaft™
Grooving
Parting-off
X4
Adapters Clamping units
Accessories and Spare parts
Workpiece materials

SWLCR/L – Toolholders for inserts WCMT – Metric

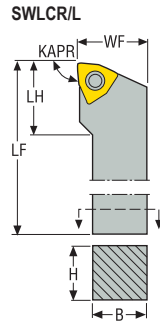

SWLCR/L
KAPR = 95,0 °

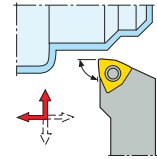



CTWS





- For inserts program, see page(s) 567
- GAMO° = Rake angle, LAMS° = Inclination angle
- CTWS = Insert shape and size
- For holder code key, see page(s) 15-16
- Right-hand version shown
- Please check availability at www.secotools.com / Seco Online Store

Designation	Item number	H	B	LF	WF	LH	KAPR°	GAMO°	LAMS°	Weight	CTWS
		mm	mm	mm	mm	mm				kg	
SWLCR1616H06	75066173	16	16	100	20,0	20,0	95,0	0,0	0,0	0,2	WCMT06T3..
SWLCR2020K06	75066175	20	20	125	25,0	21,0	95,0	0,0	0,0	0,4	WCMT06T3..
SWLCL1616H06	75066174	16	16	100	20,0	20,0	95,0	0,0	0,0	0,2	WCMT06T3..
SWLCL2020K06	75066176	20	20	125	25,0	21,0	95,0	0,0	0,0	0,4	WCMT06T3..

Spare Parts

For size	Insert key	Insert screw
...06	 T15P-2	 C03510-T15P

Accessories

For size	Insert clamping torque	Replacement blade	Torque key
...06	 3.0NM	 T00-15P	 T00-15P30

General ISO Turning Holders
Steadyline®
MDT
Mini-Shaft™
Grooving
Parting-off
X4
Adapters Clamping units
Accessories and Spare parts
Workpiece materials

MCKNR/L – Toolholders for inserts CNGA, CNGP, CNMA, CNMG, CNMM and CNMP – Inch

MCKNR/L
KAPR = 75,0°

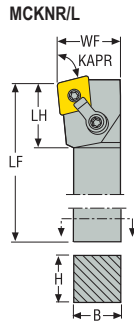
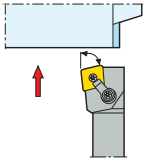



CTWS



- For inserts program, see page(s) 527, 528, 529, 530, 531, 532, 533, 575, 576
- GAMO° = Rake angle, LAMS° = Inclination angle
- CTWS = Insert shape and size
- For holder code key, see page(s) 17-18
- Shim CSN-642 for insert CN..63., to be ordered separately
- Right-hand version shown
- Please check availability at www.secotools.com / Seco Online Store

Designation	Item number	H	B	LF	WF	LH	KAPR°	GAMO°	LAMS°	Weight	CTWS
		Inch	Inch	Inch	Inch	Inch				lbs	
MCKNR-20-6D	00012996	1.250	1.250	6.815	1.500	1.280	75,0	-6,0	-6,0	2.870	CN..64.

Spare Parts

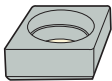
For size	Cantilever clamp	Clamp screw	Insert pin	Insert shim
..-6	 CL-12	 XNS-510	 NL-68	 CSN-633

Accessories

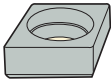
For size	Insert shim
..-6	 CSN-642

General ISO Turning
Holders

Steadyline®

MDT

Mini-Shaft™

Grooving

Parting-off

X4

Adapters
Clamping units

Accessories and
Spare parts

Workpiece
materials

MCLNR/L – Toolholders for inserts CNGA, CNGN, CNGP, CNMA, CNMG, CNMM and CNMP – Inch

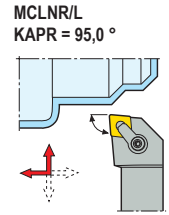
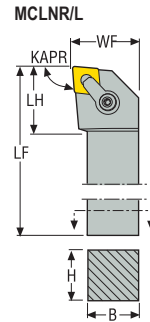



CTWS



- For inserts program, see page(s) 527, 528, 529, 530, 531, 532, 533, 575, 576
- GAMO° = Rake angle, LAMS° = Inclination angle
- CTWS = Insert shape and size
- For holder code key, see page(s) 17-18
- Right-hand version shown
- Please check availability at www.secotools.com / Seco Online Store

Designation	Item number	H	B	LF	WF	LH	KAPR°	GAMO°	LAMS°	Weight	CTWS
		Inch	Inch	Inch	Inch	Inch				lbs	
MCLNR-16-6D	00012668	1.000	1.000	6.000	1.250	1.575	95,0	-6,0	-6,0	1.980	CN..64.
MCLNR-24-6E	00013014	1.500	1.500	7.000	2.000	1.575	95,0	-6,0	-6,0	4.630	CN..64.
MCLNL-16-6D	00012669	1.000	1.000	6.000	1.250	1.575	95,0	-6,0	-6,0	1.980	CN..64.
MCLNL-24-6E	00013003	1.500	1.500	7.000	2.000	1.575	95,0	-6,0	-6,0	4.850	CN..64.
MCLNR-24-8E	00013016	1.500	1.500	7.000	2.000	1.575	95,0	-6,0	-6,0	5.070	CN..86.
MCLNL-24-8E	00013004	1.500	1.500	7.000	2.000	1.575	95,0	-6,0	-6,0	4.850	CN..86.

Spare Parts

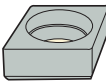
For size	Cantilever clamp	Clamp screw	Insert pin	Insert shim
..-6	 CL-12	 XNS-510	 NL-68	 CSN-633
..-8	CL-24	XNS610	NL-810	CSN-846

MCMNN – Toolholders for inserts CNGP, CNMA, CNMG, CNMM, CNMN and CNMP – Inch



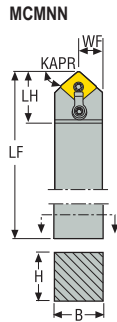
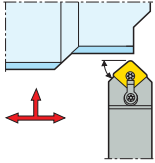



MCMNN
KAPR = 40,0°

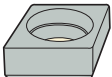

- For inserts program, see page(s) 527, 528, 529, 530, 531, 532, 533, 577
- GAMO° = Rake angle, LAMS° = Inclination angle
- CTWS = Insert shape and size
- For holder code key, see page(s) 17-18
- Neutral version shown
- Please check availability at www.secotools.com / Seco Online Store

Designation	Item number	H	B	LF	WF	LH	KAPR°	GAMO°	LAMS°	Weight	CTWS
		Inch	Inch	Inch	Inch	Inch				lbs	
MCMNN-16-4	00042505	1.000	1.000	6.000	0.500	1.202	40,0	0,0	-7,0	1.760	CN.43.
MCMNN-20-6	00042506	1.250	1.250	7.000	0.625	1.660	40,0	0,0	-7,0	3.310	CN.64.

Spare Parts

For size	Cantilever clamp	Clamp screw	Insert pin	Insert shim
..-4	 CL-20	 XNS-48	 NL-46	 CSN-433
..-6	 CL-12	 XNS-510	 NL-68	 CSN-633

Accessories

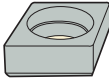
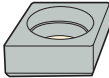
For size	Anvil
..-4	 -
..-6	 CSN-642

General ISO Turning Holders
Steadyline®
MDT
Mini-Shaft™
Grooving
Parting-off
X4
Adapters Clamping units
Accessories and Spare parts
Workpiece materials

MCRNR/L – Toolholders for inserts CNGA, CNGN, CNGP, CNMA, CNMG, CNMM and CNMP – Inch

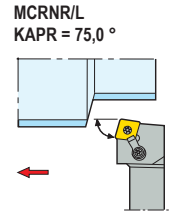
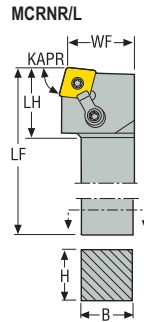

CTWS



- For inserts program, see page(s) 527, 528, 529, 530, 531, 532, 533, 575, 576
- GAMO° = Rake angle, LAMS° = Inclination angle
- CTWS = Insert shape and size
- For holder code key, see page(s) 17-18
- Shim CSN-642 for insert CN..63., to be ordered separately
- Right-hand version shown
- Please check availability at www.secotools.com / Seco Online Store

Designation	Item number	H	B	LF	WF	LH	KAPR°	GAMO°	LAMS°	Weight	CTWS
		Inch	Inch	Inch	Inch	Inch				lbs	
MCRNR-16-4D	00013033	1.000	1.000	6.000	1.250	1.258	75,0	-6,0	-6,0	1.760	CN..43.
MCRNL-16-4D	00012574	1.000	1.000	6.000	1.250	1.258	75,0	-6,0	-6,0	1.760	CN..43.
MCRNR-20-6D	00013038	1.250	1.250	6.024	1.500	1.496	75,0	-6,0	-6,0	2.870	CN..64.

Spare Parts

For size	Cantilever clamp	Clamp screw	Insert pin	Insert shim
..-4	 CL-9	 XNS58	 NL-46	 CSN-433
..-6	CL-12	XNS-510	NL-68	CSN-633

Accessories

For size	Insert shim
..-4	-
..-6	CSN-642

General ISO Turning Holders
Steadyline®
MDT
Mini-Shaft™
Grooving
Parting-off
X4
Adapters Clamping units
Accessories and Spare parts
Workpiece materials

MDJNR/L – Toolholders for inserts DNGA, DNGM, DNGP, DNMA, DNMG, DNMP, DNMU and DNMX – Inch



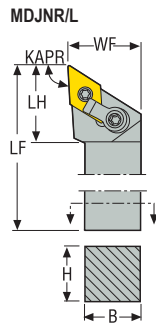
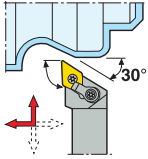

MDJNR/L
KAPR = 93,0°



- For inserts program, see page(s) 537, 538, 539, 540, 541, 579, 580, 598
- GAMO° = Rake angle, LAMS° = Inclination angle
- CTWS = Insert shape and size
- For holder code key, see page(s) 17-18
- Right-hand version shown
- * Use the right shim & the right screw for the selected insert. For details, see page 99
- Please check availability at www.secotools.com / Seco Online Store

Designation	Item number	H	B	LF	WF	LH	KAPR°	GAMO°	LAMS°	Weight	CTWS
		Inch	Inch	Inch	Inch	Inch				lbs	
MDJNR-16-4D	00012698	0.750	0.750	6.000	1.000	1.246	93,0	-6,0	-6,0	1.980	DN..43/DN..44*
MDJNR-24-4D	00012708	1.500	1.500	6.000	2.000	1.325	93,0	-6,0	-6,0	3.750	DN..43/DN..44*
MDJNL-16-4D	00012699	0.750	0.750	6.000	1.000	1.246	93,0	-6,0	-6,0	1.760	DN..43/DN..44*
MDJNL-24-4D	00012709	1.500	1.500	6.000	2.000	1.325	93,0	-6,0	-6,0	3.750	DN..43/DN..44*

Spare Parts

For size	Cantilever clamp	Clamp screw	Insert pin	Insert shim
..4	 CL-20	 XNS-48	 NL-46	 DSN-433

Accessories

For size	Insert shim
..4	 DSN-423

MRGNR/L – Toolholders for inserts RNGN, RNMA, RNMG and RNMN – Inch

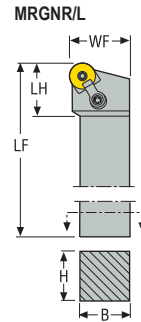

MRGNR/L
KAPR = 90,0 °

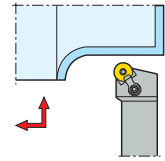



CTWS



- For inserts program, see page(s) 547, 582, 601, 604
- GAMO° = Rake angle, LAMS° = Inclination angle
- CTWS = Insert shape and size
- For holder code key, see page(s) 17-18
- Shim DSN120416 for insert SN..1206.., to be ordered separately
- Right-hand version shown
- Please check availability at www.secotools.com / Seco Online Store

Designation	Item number	H	B	LF	WF	LH	KAPR°	GAMO°	LAMS°	Weight	CTWS
		Inch	Inch	Inch	Inch	Inch				lbs	
MRGNR-12-4B	00013087	0.750	0.750	4.500	1.000	1.260	90,0	-6,0	-6,0	0.880	RNM.43
MRGNL-12-4B	00013073	0.750	0.750	4.500	1.000	1.260	90,0	-6,0	-6,0	0.880	RNM.43

Spare Parts

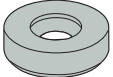
For size	Cantilever clamp	Clamp screw	Insert pin	Insert shim
..4	 CL-9	 XNS59	 NL-46	 IRSN-43

General ISO Turning Holders
Steadyline®
MDT
Mini-Shaft™
Grooving
Parting-off
X4
Adapters Clamping units
Accessories and Spare parts
Workpiece materials

MRGOR/L – Toolholders for inserts RCMM – Inch

MRGOR/L
KAPR = 90,0°

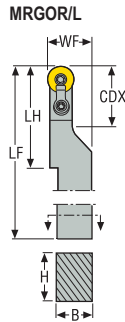
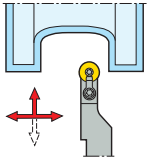











CTWS

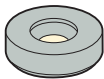

- For inserts program, see page(s) 545, 546
- GAMO° = Rake angle, LAMS° = Inclination angle
- CTWS = Insert shape and size
- For holder code key, see page(s) 17-18
- Shim DSN120416 for insert SN..1206..., to be ordered separately
- Right-hand version shown
- Please check availability at www.secotools.com / Seco Online Store

Designation	Item number	H	B	LF	WF	LH	CDX	KAPR°	GAMO°	LAMS°	Weight	CTWS
		Inch	Inch	Inch	Inch	Inch	Inch				lbs	
MRGOR-85-4D	00013107	1.250	1.000	6.000	1.250	2.338	1.000	90,0	0,0	0,0	1.760	RCMM43
MRGOL-85-4D	00013103	1.250	1.000	6.000	1.250	2.338	1.000	90,0	0,0	0,0	1.760	RCMM43
MRGOR-20-6E	00013104	1.250	1.250	7.000	1.500	3.530	1.750	90,0	0,0	0,0	2.430	RCMM64
MRGOL-20-6E	00013101	1.250	1.250	7.000	1.500	3.530	1.750	90,0	0,0	0,0	2.430	RCMM64
MRGOR-24-8E	00013106	1.500	1.500	7.000	2.287	2.010	2.000	90,0	0,0	0,0	3.530	RCMM84
MRGOL-24-8E	00013102	1.500	1.500	7.000	2.287	2.010	2.000	90,0	0,0	0,0	3.530	RCMM84

Spare Parts

For size	Cantilever clamp	Clamp screw	Insert pin	Insert shim
..-4	 CL-6	 XNS-36	 PL-46	 RS-43P
..-6	 CL-9	 XNS58	 PL-68	 RS-63P
..-8	 CL-12	 XNS58	 PL-68	 RS-83P

General ISO Turning
Holders

Steadyline®

MDT

Mini-Shaft™

Grooving

Parting-off

X4

Adapters
Clamping units

Accessories and
Spare parts

Workpiece
materials

MSBNR/L – Toolholders for inserts SNMA, SNMG and SNMM – Metric

General ISO Turning
Holders

Steadyline®

MDT

Mini-Shaft™

Grooving

Parting-off

X4

Adapters
Clamping units

Accessories and
Spare parts

Workpiece
materials

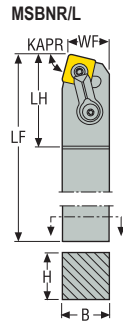

MSBNR/L
KAPR = 75,0 °

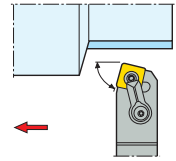

CTWS



- For inserts program, see page(s) 550, 551, 552, 553
- GAMO° = Rake angle, LAMS° = Inclination angle
- CTWS = Insert shape and size
- For holder code key, see page(s) 15-16
- Right-hand version shown
- Please check availability at www.secotools.com / Seco Online Store

Designation	Item number	H	B	LF	WF	LH	KAPR°	GAMO°	LAMS°	Weight	CTWS
		mm	mm	mm	mm	mm				kg	
MSBNR3232P19	02464174	32	32	170	27,0	45,0	75,0	-6,0	-6,0	1,4	SN..1906..
MSBNR4040R19	02464204	40	40	200	35,0	45,0	75,0	-6,0	-6,0	2,4	SN..1906..
MSBNL3232P19	02464202	32	32	170	27,0	45,0	75,0	-6,0	-6,0	1,4	SN..1906..
MSBNL4040R19	02464206	40	40	200	35,0	45,0	75,0	-6,0	-6,0	2,4	SN..1906..

Spare Parts

For size	Cantilever clamp	Clamp screw	Insert shim	Shim/clamp key	Shim pin
...19	MC22	LD6024-T20P	SSN190412	T20P-7L	MN1920-T20P

Accessories

For size	Insert clamping torque	Replacement blade	Torque key
...19	3.0NM	T00-15P	T00-15P30

MSDNN – Toolholders for inserts SNGA, SNGN, SNMA, SNMG, SNMM, SNMN and SNMP – Inch

MSDNN
KAPR = 45,0°

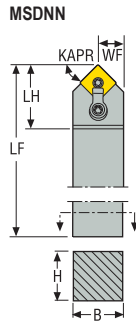
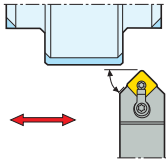





CTWS



- For inserts program, see page(s) 550, 551, 552, 553, 585, 586
- GAMO° = Rake angle, LAMS° = Inclination angle
- CTWS = Insert shape and size
- For holder code key, see page(s) 17-18
- Shim DSN120416 for insert SN..1206..., to be ordered separately
- Neutral version shown
- Please check availability at www.secotools.com / Seco Online Store

Designation	Item number	H	B	LF	WF	LH	KAPR°	GAMO°	LAMS°	Weight	CTWS
		Inch	Inch	Inch	Inch	Inch				lbs	
MSDNN-8-3	00013325	0.500	0.500	4.500	0.250	1.043	45,0	0,0	-7,0	0.440	SN..32.
MSDNN-10-3	00013330	0.625	0.625	4.500	0.375	1.402	45,0	-6,0	-6,0	0.660	SN..32.
MSDNN-12-4	00013340	0.750	0.750	6.000	0.375	1.402	45,0	-6,0	-6,0	0.880	SN..43.
MSDNN-16-4	00013345	1.000	1.000	6.000	0.500	1.402	45,0	0,0	-7,0	1.760	SN..43.
MSDNN-16-5	00013360	1.000	1.000	6.000	0.500	1.607	45,0	-6,0	-6,0	1.760	SN..54.
MSDNN-20-5	00042536	1.250	1.250	7.000	0.625	1.607	45,0	-6,0	-6,0	3.090	SN..54.
MSDNN-20-6	00013375	1.250	1.250	7.000	0.625	1.732	45,0	-6,0	-6,0	3.310	SN..64.
MSDNN-24-6	00013390	1.500	1.500	7.000	0.750	1.732	45,0	-6,0	-6,0	4.190	SN..64.
MSDNN-24-8	00042538	1.500	1.500	7.000	0.750	2.223	45,0	0,0	-8,0	4.410	SN..86.

Spare Parts

For size	Cantilever clamp	Clamp screw	Insert pin	Insert shim
..3	 CL-6	 XNS-36	 NL-34	 ISSN-322
..4	CL-9	XNS59	NL-46	ISSN-433
..5	CL-12	XNS-510	NL-58	SSN533
..6	CL-12	XNS-510	NL-68	ISSN-633
..8	CL-24	XNS610	NL-810	SSN844

Accessories

For size	Insert shim
..3	 -
..4	-
..5	-
..6	ISSN-643
..8	-

General ISO Turning
Holders

Steadyline®

MDT

Mini-Shaft™

Grooving

Parting-off

X4

Adapters
Clamping units

Accessories and
Spare parts

Workpiece
materials

MSRNR – Toolholders for inserts SNMG and SNMM – Metric

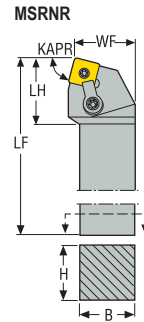

MSRNR
KAPR = 75,0 °

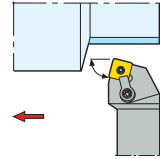

CTWS



- For inserts program, see page(s) 550, 551, 552, 553
- GAMO° = Rake angle, LAMS° = Inclination angle
- CTWS = Insert shape and size
- For holder code key, see page(s) 15-16
- Shim [SSN250616](#) for insert SN..2509..., to be ordered separately
- Right-hand version shown
- Please check availability at www.secotools.com / Seco Online Store

Designation	Item number	H	B	LF	WF	LH	KAPR°	GAMO°	LAMS°	Weight	CTWS
		mm	mm	mm	mm	mm				kg	
MSRNR5050T25	75000199	50	50	300	53,2	49,0	75,0	-6,0	-6,0	5,7	SN..2507..

Spare Parts

For size	Clamp	Clamp screw	Insert shim	Key	Pin
...25	 MC24	 LD1035-T25P	 SSN250716	 T25P-7	 MN2525-T25P

Accessories

For size	Insert clamping torque	Replacement blade	Shim screw	Torque key
...25	 6.0NM	 T00T-25P	 CS1216	 T00T-25P60

General ISO Turning Holders
Steadyline®
MDT
Mini-Shaft™
Grooving
Parting-off
X4
Adapters Clamping units
Accessories and Spare parts
Workpiece materials

MSRNR/L – Toolholders for inserts SNGA, SNGN, SNMA, SNMG, SNMM, SNMN and SNMP – Inch

MSRNR/L
KAPR = 75,0°

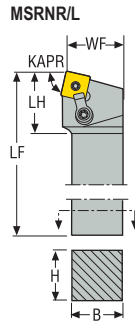
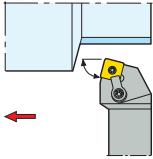

CTWS



- For inserts program, see page(s) 550, 551, 552, 553, 585, 586
- GAMO° = Rake angle, LAMS° = Inclination angle
- CTWS = Insert shape and size
- For holder code key, see page(s) 17-18
- Shim [SSN250616](#) for insert SN..2509..., to be ordered separately
- Right-hand version shown
- Please check availability at www.secotools.com / Seco Online Store

Designation	Item number	H	B	LF	WF	LH	KAPR°	GAMO°	LAMS°	Weight	CTWS
		Inch	Inch	Inch	Inch	Inch					
MSRNR-12-4B	00012743	0.750	0.750	4.500	0.878	1.260	75,0	0,0	-6,0	0.880	SN..43.
MSRNR-16-4D	00012748	1.000	1.000	6.000	1.128	1.260	75,0	-6,0	-6,0	1.980	SN..43.
MSRNL-12-4B	00012744	0.750	0.750	4.500	0.878	1.260	75,0	0,0	-6,0	0.880	SN..43.
MSRNL-16-4D	00012749	1.000	1.000	6.000	1.128	1.260	75,0	-6,0	-6,0	1.980	SN..43.
MSRNR-20-5D	00012753	1.250	1.250	6.000	1.350	1.496	75,0	-6,0	-6,0	2.870	SN..54.
MSRNL-16-5D	00071776	1.000	1.000	6.000	1.100	1.496	75,0	-6,0	-6,0	1.980	SN..54.
MSRNL-20-5D	00012754	1.250	1.250	6.000	1.350	1.496	75,0	-6,0	-6,0	2.870	SN..54.
MSRNR-20-6D	00012756	1.250	1.250	6.000	1.318	1.535	75,0	-6,0	-6,0	2.870	SN..64.
MSRNR-24-6E	00013118	1.500	1.500	7.000	1.818	1.513	75,0	-6,0	-6,0	4.630	SN..64.
MSRNL-20-6D	00012757	1.250	1.250	6.000	1.318	1.535	75,0	-6,0	-6,0	2.870	SN..64.
MSRNL-24-6E	00013114	1.500	1.500	7.000	1.818	1.513	75,0	-6,0	-6,0	4.630	SN..64.

Spare Parts

For size	Cantilever clamp	Clamp screw	Insert pin	Insert shim
..4	 CL-9	 XNS59	 NL-46	 ISSN-433
..5	CL-12	XNS-510	NL-58	SSN533
..6	CL-12	XNS-510	NL-68	ISSN-633

Accessories

For size	Insert shim
..4	–
..5	–
..6	ISSN-643

MTCNN – Toolholders for inserts TNGN, TNMA, TNMG, TNMM, TNMN and TNMP – Inch

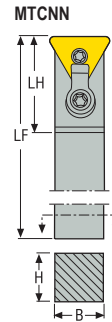

MTCNN
KAPR = 90,0 °

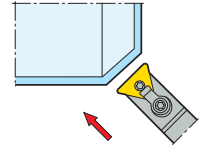

CTWS



- For inserts program, see page(s) 558, 559, 560, 561, 591, 592
- GAMO° = Rake angle, LAMS° = Inclination angle
- CTWS = Insert shape and size
- For holder code key, see page(s) 17-18
- Right-hand version shown
- Please check availability at www.secotools.com / Seco Online Store

Designation	Item number	H	B	LF	WF	LH	KAPR°	GAMO°	LAMS°	Weight	CTWS
		Inch	Inch	Inch	Inch	Inch				lbs	
MTCNN-44-3	00013835	1.000	0.500	8.000	0.075	1.147	90,0	-7,0	0,0	1.320	TN..33.
MTCNN-12-4	00013830	0.750	0.750	6.000	–	1.430	90,0	-7,0	0,0	1.100	TN..43.
MTCNN-64-4	00013840	1.000	0.750	8.000	–	1.430	90,0	-7,0	0,0	1.760	TN..43.

Spare Parts

For size	Cantilever clamp	Clamp screw	Insert pin	Insert shim
...3	 CL-7	 XNS-36	 NL-34L	 ITSN-323
...4	 CL-12	 XNS-510	 NL-46	 ITSN-433

Accessories

For size	Insert shim
...3	 ITSN-333
...4	 TS-424

General ISO Turning Holders
Steadyline®
MDT
Mini-Shaft™
Grooving
Parting-off
X4
Adapters Clamping units
Accessories and Spare parts
Workpiece materials

MTENNS – Toolholders for inserts TNGA, TNMA, TNMG, TNMM and TNMP – Inch

MTENNS
KAPR = 60,0°

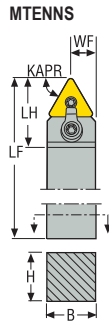
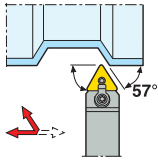

- For inserts program, see page(s) 558, 559, 560, 561, 590
- GAMO° = Rake angle, LAMS° = Inclination angle
- CTWS = Insert shape and size
- For holder code key, see page(s) 17-18
- Right-hand version shown
- Please check availability at www.secotools.com / Seco Online Store

Designation	Item number	H	B	LF	WF	LH	KAPR°	GAMO°	LAMS°	Weight	CTWS
		Inch	Inch	Inch	Inch	Inch				lbs	
MTENNS-8-2	00013850	0.500	0.500	4.500	0.250	0.990	60,0	0,0	-10,0	0.440	TN..22.
MTENNS-10-3	00013855	0.625	0.625	4.500	0.315	1.181	60,0	0,0	-10,0	0.660	TN..33.
MTENNS-12-3	00013860	0.750	0.750	4.500	0.376	1.160	60,0	0,0	-10,0	0.660	TN..33.
MTENNS-64-3	00013890	1.000	0.750	6.024	0.375	0.375	60,0	0,0	-10,0	1.320	TN..33.
MTENNS-12-4	00013865	0.750	0.750	4.500	0.374	1.500	60,0	0,0	-10,0	0.880	TN..43.
MTENNS-16-4	00013870	1.000	1.000	6.000	0.500	1.500	60,0	0,0	-10,0	1.980	TN..43.
MTENNS-20-5	00013875	1.250	1.250	7.008	0.625	1.654	60,0	0,0	-10,0	3.090	TN..54.
MTENNS-24-5	00013880	1.500	1.500	7.008	0.750	1.654	60,0	0,0	-10,0	3.090	TN..54.
MTENNS-24-6	00013885	1.500	1.500	7.008	0.750	1.969	60,0	0,0	-10,0	4.410	TN..66.

Spare Parts

For size	Cantilever clamp	Clamp screw	Insert pin	Insert shim
..-2	CL-6	XNS-36	NL-23	-
..-3	CL-6	XNS-36	NL-34L	ITSN-323
..-4	CL-9	XNS59	NL-46	ITSN-433
..-5	CL-9	XNS-510	NL-58	ITSN-533
..-6	CL-12	XNS-510	NL-68L	TSN-637

Accessories

For size	Insert shim
..-2	-
..-3	ITSN-333
..-4	-
..-5	-
..-6	-

General ISO Turning Holders
Steadyline®
MDT
Mini-Shaft™
Grooving
Parting-off
X4
Adapters Clamping units
Accessories and Spare parts
Workpiece materials

MTFNR/L – Toolholders for inserts TNGA, TNGN, TNMA, TNMG, TNMM, TNMN and TNMP – Inch

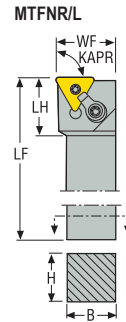

MTFNR/L
KAPR = 90,0 °

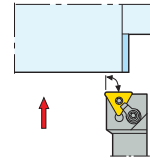





CTWS



- For inserts program, see page(s) 558, 559, 560, 561, 590, 591, 592
- GAMO° = Rake angle, LAMS° = Inclination angle
- CTWS = Insert shape and size
- For holder code key, see page(s) 17-18
- Right-hand version shown
- Please check availability at www.secotools.com / Seco Online Store

Designation	Item number	H	B	LF	WF	LH	KAPR°	GAMO°	LAMS°	Weight	CTWS
		Inch	Inch	Inch	Inch	Inch				lbs	
MTFNR-10-3	00013930	0.625	0.625	4.500	0.875	0.930	90,0	-5,0	-5,0	0.660	TN..33.
MTFNR-16-5D	00013144	1.000	1.000	6.000	1.250	1.457	90,0	-5,0	-6,0	1.980	TN..54.

Spare Parts

For size	Cantilever clamp	Clamp screw	Insert pin	Insert shim
..-3	 CL-6	 XNS-36	 NL-34L	 ITSN-323
..-5	CL-12	XNS-510	NL-58	ITSN-533

Accessories

For size	Insert shim
..-3	 ITSN-333
..-5	-

General ISO Turning Holders
Steadyline®
MDT
Mini-Shaft™
Grooving
Parting-off
X4
Adapters Clamping units
Accessories and Spare parts
Workpiece materials

MTGNR/L – Toolholders for inserts TNGA, TNGN, TNMA, TNMG, TNMM, TNMN and TNMP – Inch



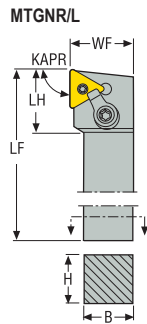
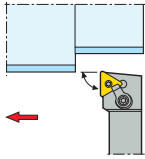





MTGNR/L
KAPR = 90,0°



- For inserts program, see page(s) 558, 559, 560, 561, 590, 591, 592
- GAMO° = Rake angle, LAMS° = Inclination angle
- CTWS = Insert shape and size
- For holder code key, see page(s) 17-18
- Right-hand version shown
- Please check availability at www.secotools.com / Seco Online Store

Designation	Item number	H	B	LF	WF	LH	KAPR°	GAMO°	LAMS°	Weight	CTWS
		Inch	Inch	Inch	Inch	Inch				lbs	
MTGNR-8-2A	00014171	0.500	0.500	4.000	0.625	0.940	90,0	-5,0	-5,0	0.440	TN..22.
MTGNL-8-2A	00014176	0.500	0.500	4.000	0.625	0.940	90,0	-5,0	-5,0	0.440	TN..22.
MTGNR-10-3A	00013167	0.625	0.625	4.000	0.625	1.181	90,0	-5,0	-5,0	0.660	TN..33.
MTGNL-10-3A	00013153	0.625	0.625	4.000	0.625	1.181	90,0	-5,0	-5,0	0.660	TN..33.
MTGNR-24-5D	00012816	1.496	1.500	6.000	2.000	4.540	90,0	-5,0	-5,0	4.410	TN..54.
MTGNL-24-5D	00012817	1.496	1.500	6.000	2.000	4.540	90,0	-5,0	-5,0	4.410	TN..54.

Spare Parts

For size	Cantilever clamp	Clamp screw	Insert pin	Insert shim
..-2	 CL-19	 XNS-36	 NL-23	-
..-3	 CL-6	 XNS-36	 NL-34L	ITSN-323
..-5	 CL-9	 XNS-510	 NL-58	ITSN-533

Accessories

For size	Insert shim
..-2	 -
..-3	ITSN-333
..-5	-

MTJNR/LS – Toolholders for inserts TNGA, TNMA, TNMG, TNMM and TNMP – Inch

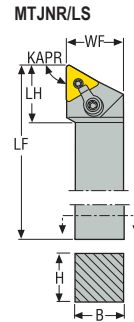

MTJNRS/LS
KAPR = 93,0 °

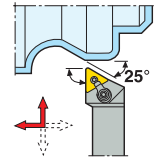

CTWS



- For inserts program, see page(s) 558, 559, 560, 561, 590
- GAMO° = Rake angle, LAMS° = Inclination angle
- CTWS = Insert shape and size
- For holder code key, see page(s) 17-18
- Shim ITS333 for insert TN..32., to be ordered separately
- Right-hand version shown
- Please check availability at www.secotools.com / Seco Online Store

Designation	Item number	H	B	LF	WF	LH	KAPR°	GAMO°	LAMS°	Weight	CTWS
		Inch	Inch	Inch	Inch	Inch				lbs	
MTJNRS-12-3	00040974	0.750	0.750	4.500	1.000	1.120	93,0	-5,0	-5,0	0.880	TN..33.
MTJNLS-12-3	00040975	0.750	0.750	4.500	1.000	1.120	93,0	-5,0	-5,0	0.880	TN..33.
MTJNRS-16-4D	00014440	1.000	1.000	6.000	1.250	1.190	93,0	-5,0	-5,0	1.980	TN..43.
MTJNLS-16-4	00014445	1.000	1.000	6.000	1.250	1.190	93,0	-5,0	-5,0	1.980	TN..43.
MTJNRS-20-5	00014450	1.250	1.252	7.008	1.500	1.441	93,0	-5,0	-5,0	2.650	TN..54.
MTJNRS-24-5	00014460	1.500	1.500	7.008	2.000	1.441	93,0	-5,0	-5,0	5.070	TN..54.
MTJNLS-20-5	00014455	1.250	1.252	7.008	1.500	1.441	93,0	-5,0	-5,0	3.310	TN..54.
MTJNLS-24-5	00014465	1.500	1.500	7.008	2.000	1.441	93,0	-5,0	-5,0	4.630	TN..54.
MTJNRS-24-6	00040978	1.500	1.500	7.008	2.000	1.669	93,0	-5,0	-5,0	4.630	TN..66.
MTJNLS-24-6	00040979	1.500	1.500	7.008	2.000	1.669	93,0	-5,0	-5,0	4.630	TN..66.

Spare Parts

For size	Cantilever clamp	Clamp screw	Insert pin	Insert shim
..-3	CL-6	XNS-36	NL-34L	ITS333
..-4	CL-9	XNS-510	NL-46	ITS333
..-5	CL-9	XNS-510	NL-58	ITS333
..-6	CL-9	XNS-510	NL-68L	TSN-637

Accessories

For size	Insert shim
..-3	ITS333
..-4	-
..-5	-
..-6	-

MTLNR/L – Toolholders for inserts TNGA, TNGN, TNMA, TNMG, TNMM, TNMN and TNMP – Inch



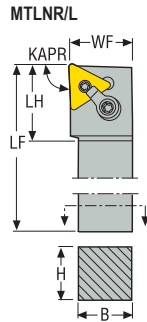
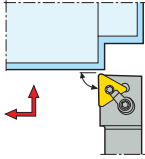

MTLNR/L
KAPR = 95,0°



- For inserts program, see page(s) 558, 559, 560, 561, 590, 591, 592
- GAMO° = Rake angle, LAMS° = Inclination angle
- CTWS = Insert shape and size
- For holder code key, see page(s) 17-18
- Right-hand version shown
- Please check availability at www.secotools.com / Seco Online Store

Designation	Item number	H	B	LF	WF	LH	KAPR°	GAMO°	LAMS°	Weight	CTWS
		Inch	Inch	Inch	Inch	Inch				lbs	
MTLNR-16-4	00042542	1.000	1.000	6.000	1.250	1.299	95,0	-5,0	-5,0	1.980	TN.43.
MTLNL-16-4	00042543	1.000	1.000	6.000	1.250	1.299	95,0	-5,0	-5,0	1.980	TN.43.

Spare Parts

For size	Cantilever clamp	Clamp screw	Insert pin	Insert shim
...4	 CL-9	 XNS-510	 NL-46	 TS-424

General ISO Turning Holders
Steadyline®
MDT
Mini-Shaft™
Grooving
Parting-off
X4
Adapters Clamping units
Accessories and Spare parts
Workpiece materials

MVJNR/L – Toolholders for inserts VNGA, VNGM, VNGP, VNMA, VNMG, VNMP and VNMU – Inch

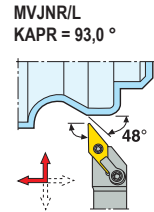
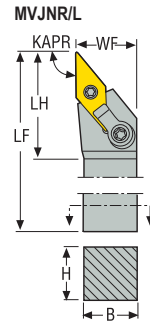



CTWS



- For inserts program, see page(s) 565, 566, 595
- GAMO° = Rake angle, LAMS° = Inclination angle
- CTWS = Insert shape and size
- For holder code key, see page(s) 17-18
- Right-hand version shown
- Please check availability at www.secotools.com / Seco Online Store

Designation	Item number	H	B	LF	WF	LH	KAPR°	GAMO°	LAMS°	Weight	CTWS
		Inch	Inch	Inch	Inch	Inch				lbs	
MVJNR-16-3D	00071714	1.000	1.000	6.000	1.250	1.681	93,0	-4,0	-13,0	1.540	VN..33.
MVJNL-16-3D	00071708	1.000	1.000	6.000	1.250	1.681	93,0	-4,0	-13,0	1.540	VN..33.
MVJNR-16-4D	00012879	1.000	1.000	6.000	1.250	2.018	93,0	-4,0	-13,0	1.540	VN..43.
MVJNR-20-4D	00012888	1.250	1.250	6.000	1.500	2.018	93,0	-4,0	-13,0	2.430	VN..43.
MVJNL-16-4D	00012883	1.000	1.000	6.000	1.250	2.018	93,0	-4,0	-13,0	1.540	VN..43.
MVJNL-20-4D	00012889	1.250	1.250	6.000	1.500	2.018	93,0	-4,0	-13,0	2.430	VN..43.

Spare Parts

For size	Cantilever clamp	Clamp screw	Insert pin	Insert shim
..-3	 CL-30	 XNS-510	 NL-34L	IVSN-324
..-4	CL-30	XNS-510	NL-46	IVSN-433

MVLNR/L – Toolholders for inserts VNGA, VNGM, VNGP, VNMA, VNMG and VNMP – Inch

MVLNR/L
KAPR = 95,0°

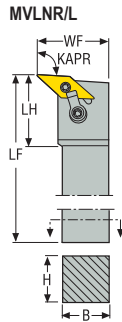
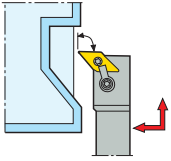





CTWS



- For inserts program, see page(s) 565, 566, 595
- GAMO° = Rake angle, LAMS° = Inclination angle
- CTWS = Insert shape and size
- For holder code key, see page(s) 17-18
- Right-hand version shown
- Please check availability at www.secotools.com / Seco Online Store

Designation	Item number	H	B	LF	WF	LH	KAPR°	GAMO°	LAMS°	Weight	CTWS
		Inch	Inch	Inch	Inch	Inch				lbs	
MVLNR-16-4D	00013206	1.000	1.000	6.000	1.750	1.497	95,0	-4,0	-13,0	2.200	VN.43.
MVLNR-20-4D	00013207	1.250	1.250	6.000	2.000	1.498	95,0	-4,0	-13,0	3.090	VN.43.
MVLNL-16-4D	00013198	1.000	1.000	6.000	1.750	1.497	95,0	-4,0	-13,0	1.980	VN.43.
MVLNL-20-4D	00013199	1.250	1.250	6.000	2.000	1.498	95,0	-4,0	-13,0	3.090	VN.43.

Spare Parts

For size	Cantilever clamp	Clamp screw	Insert pin	Insert shim
..-4	 CL-12	 XNS-510	 NL-46	 IVSN-433

General ISO Turning Holders
Steadyline®
MDT
Mini-Shaft™
Grooving
Parting-off
X4
Adapters Clamping units
Accessories and Spare parts
Workpiece materials

MVTNR/L – Toolholders for inserts VNGA, VNGM, VNGP, VNMA, VNMG and VNMP – Inch

General ISO Turning
Holders

Steadyline®

MDT

Mini-Shaft™

Grooving

Parting-off

X4

Adapters
Clamping units

Accessories and
Spare parts

Workpiece
materials

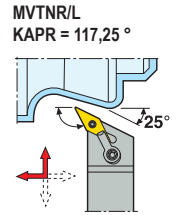
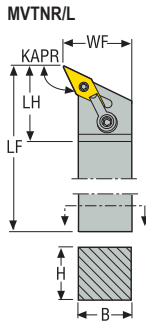

CTWS



- For inserts program, see page(s) 565, 566, 595
- GAMO° = Rake angle, LAMS° = Inclination angle
- CTWS = Insert shape and size
- For holder code key, see page(s) 17-18
- Right-hand version shown
- Please check availability at www.secotools.com / Seco Online Store

Designation	Item number	H	B	LF	WF	LH	KAPR°	GAMO°	LAMS°	Weight	CTWS
		Inch	Inch	Inch	Inch	Inch				lbs	
MVTNR-12-3B	00049604	0.750	0.750	4.500	1.000	1.737	117,25	-4,0	-13,0	0.880	VN..33.
MVTNR-16-3D	00013222	1.000	1.000	6.000	1.250	1.800	117,25	-4,0	-13,0	1.760	VN..33.
MVTNR-20-3D	00013223	1.250	1.250	6.000	1.500	1.737	117,25	-4,0	-13,0	2.870	VN..33.
MVTNL-12-3B	00052353	0.750	0.750	4.500	1.000	1.737	117,25	-4,0	-13,0	0.880	VN..33.
MVTNL-16-3D	00013214	1.000	1.000	6.000	1.250	1.800	117,25	-4,0	-13,0	1.980	VN..33.
MVTNL-20-3D	00013216	1.250	1.250	6.000	1.500	1.737	117,25	-4,0	-13,0	2.650	VN..33.

Spare Parts

For size	Cantilever clamp	Clamp screw	Insert pin	Insert shim
..-3	 CL-30	 XNS-510	 NL-34L	 IVSN-324

MWLNRL/L – Toolholders for inserts WNGA, WNGG, WNMA, WNMG and WNMM – Metric

MWLNRL/L
KAPR = 95,0°

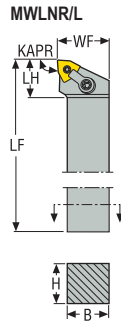
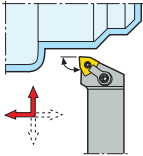

- For inserts program, see page(s) 568, 569, 570, 571, 596
- GAMO° = Rake angle, LAMS° = Inclination angle
- CTWS = Insert shape and size
- For holder code key, see page(s) 15-16
- Right-hand version shown
- * Use the right shim & the right screw for the selected insert. For details, see page 99
- Please check availability at www.secotools.com / Seco Online Store

Designation	Item number	H	B	LF	WF	LH	KAPR°	GAMO°	LAMS°	Weight	CTWS
		mm	mm	mm	mm	mm				kg	
MWLNRL2020K08	75002232	20	20	125	25,0	31,0	95,0	-6,0	-6,0	0,5	WN..0804/WN..0806*
MWLNRL2525M08	75002234	25	25	150	32,0	31,0	95,0	-6,0	-6,0	0,8	WN..0804/WN..0806*
MWLNRL3232P08	75002236	32	32	170	40,0	31,0	95,0	-6,0	-6,0	1,4	WN..0804/WN..0806*
MWLNRL2020K08	75002233	20	20	125	25,0	31,0	95,0	-6,0	-6,0	0,5	WN..0804/WN..0806*
MWLNRL2525M08	75002235	25	25	150	32,0	31,0	95,0	-6,0	-6,0	0,8	WN..0804/WN..0806*
MWLNRL3232P08	75002237	32	32	170	40,0	31,0	95,0	-6,0	-6,0	1,4	WN..0804/WN..0806*

Spare Parts

For size	Cantilever clamp	Clamp screw	Insert shim	Shim/clamp key	Shim pin
...08	MC21	LD6025-T15P	MWN080412	T15P-2	MN1215T-T15P

Accessories

For size	Insert clamping torque	Plug	Replacement blade	Torque key
...08	3.0NM	P3	T00-15P	T00-15P30

MWLN/L – Toolholders for inserts WNGA, WNGP, WNMA, WNMG, WNMM and WNMP – Inch

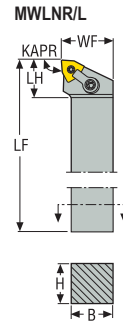

MWLN/L
KAPR = 95,0 °

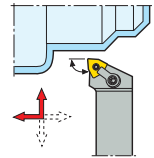





CTWS



- For inserts program, see page(s) 568, 569, 570, 571, 596
- GAMO° = Rake angle, LAMS° = Inclination angle
- CTWS = Insert shape and size
- For holder code key, see page(s) 17-18
- Shim IWSN423 for insert WN..44., to be ordered separately
- Right-hand version shown
- Please check availability at www.secotools.com / Seco Online Store

Designation	Item number	H	B	LF	WF	LH	KAPR°	GAMO°	LAMS°	Weight	CTWS
		Inch	Inch	Inch	Inch	Inch				lbs	
MWLN/L-10-3A	75056399	0.625	0.625	4.000	0.875	1.102	95,0	-6,0	-6,0	0.660	WN..33.
MWLN/L-10-3A	75056400	0.625	0.625	4.000	0.875	1.102	95,0	-6,0	-6,0	0.660	WN..33.

Spare Parts

For size	Cantilever clamp	Clamp screw	Insert pin	Insert shim
...3	 CL-6	 XNS-36	 NL-34L	 IWSN323

General ISO Turning Holders
Steadyline®
MDT
Mini-Shaft™
Grooving
Parting-off
X4
Adapters Clamping units
Accessories and Spare parts
Workpiece materials

TRAOR/L and TRDON – Toolholders for inserts RCGS – Metric / Inch

TRAOR/L
KAPR = 90,0°

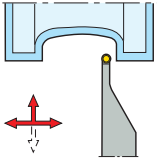

TRDON
KAPR = 45,0°

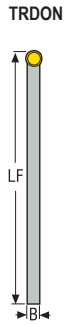
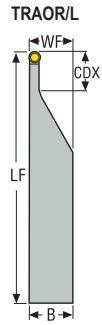
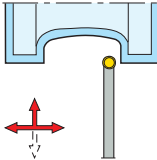

CTWS



- For inserts program, see page(s) 544, 581
- GAMO° = Rake angle, LAMS° = Inclination angle
- CTWS = Insert shape and size
- For holder code key, see page(s) 15-16
- TRAOR/L = Right-hand version shown
- TRDON = Neutral version shown
- Please check availability at www.secotools.com / Seco Online Store

Designation	Item number	H	B	LF	WF	HF	CDX	KAPR°	GAMO°	LAMS°	Weight	CTWS
		mm Inch	mm Inch	mm Inch	mm Inch	mm Inch	mm Inch	mm Inch	kg lbs			
TRAOR3225-4.76	75071805	32 1.260	25 0.984	201 7.913	25,35 0.998	31,8 1.252	-	90,0	0,0	0,0	0,8 1.760	RC.4.76 RCGS1.5
TRAOL3225-4.76	75071806	32 1.260	25 0.984	201 7.913	25,35 0.998	31,8 1.252	-	90,0	0,0	0,0	0,8 1.760	RC.4.76 RCGS1.5
TRAOR3225-6.35	75071807	32 1.260	25 0.984	150 5.906	25,5 1.004	31,8 1.252	-	90,0	0,0	0,0	0,8 1.760	RC.6.35 RCGS2
TRAOL3225-6.35	75071808	32 1.260	25 0.984	150 5.906	25,5 1.004	31,8 1.252	-	90,0	0,0	0,0	0,8 1.760	RC.6.35 RCGS2
TRAOR3225-9.525	75036398	32 1.260	25 0.984	200 7.874	25,76 1.014	31,8 1.252	-	90,0	0,0	0,0	1,1 2.430	RC.9.52 RCGS3
TRDON2004H4.76	75071812	20 0.787	4 0.157	100 3.937	4,38 0.172	19,8 0.780	3,7 0.146	45,0	0,0	0,0	0,1 0.220	RC.4.76 RCGS1.5
TRDON2005H6.35	75071813	20 0.787	6 0.217	100 3.937	5,92 0.233	19,8 0.780	4,7 0.185	45,0	0,0	0,0	0,1 0.220	RC.6.35 RCGS2

General ISO Turning
Holders

Steadyline®

MDT

Mini-Shaft™

Grooving

Parting-off

X4

Adapters
Clamping units

Accessories and
Spare parts

TRAOR/L and TRDON – Toolholders for inserts RCGS – Inch

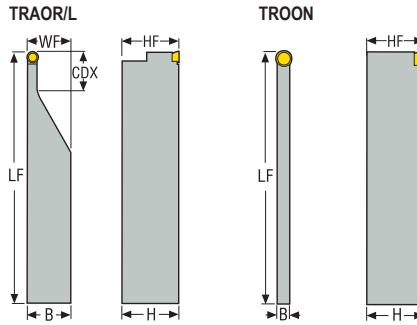

TRAOR/L
KAPR = 90,0 °

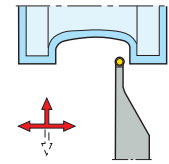

TROON
KAPR = 90,0 °

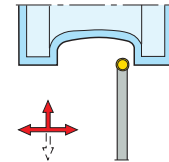

CTWS



- For inserts program, see page(s) 544, 581
- GAMO° = Rake angle, LAMS° = Inclination angle
- CTWS = Insert shape and size
- For holder code key, see page(s) 17-18
- TRAOR/L = Right-hand version shown
- TROON = Neutral version shown
- Please check availability at www.secotools.com / Seco Online Store

Designation	Item number	H	B	LF	WF	HF	CDX	KAPR°	GAMO°	LAMS°	Weight	CTWS
		Inch	Inch	Inch	Inch	Inch	Inch				lbs	
TRAOR-85-1.5	00017945	1.250	1.000	6.000	1.014	1.250	–	90,0	0,0	0,0	1.760	RCGS1.5.
TRAOL-85-1.5	75053455	1.250	1.000	6.000	1.014	1.250	–	90,0	0,0	0,0	1.760	RCGS1.5.
TRAOR-85-2	00017950	1.250	1.000	6.000	1.020	1.250	–	90,0	0,0	0,0	1.760	RCGS2.
TRAOL-85-2	00048374	1.250	1.000	6.000	1.020	1.250	–	90,0	0,0	0,0	1.980	RCGS2.
TRAOR-85-3	00017955	1.250	1.000	8.031	1.030	1.250	–	90,0	0,0	0,0	2.650	RCGS3.
TRAOL-85-3	00046228	1.250	1.000	8.031	1.030	1.250	–	90,0	0,0	0,0	2.650	RCGS3.
TROON-153-1.5	00017975	0.750	0.156	4.000	–	0.750	0.150	90,0	0,0	0,0	0.220	RCGS1.5.
TROON-23-2	00017980	0.750	0.218	4.000	–	1.252	0.189	90,0	0,0	0,0	0.220	RCGS2.
TROON-34-3	00017985	1.000	0.312	4.000	–	1.000	0.295	90,0	0,0	0,0	0.440	RCGS3.
TROON-45-4	00017990	1.250	0.433	4.000	–	1.250	0.374	90,0	0,0	0,0	0.660	RCGS4.

General ISO Turning Holders
Steadyline®
MDT
Mini-Shaft™
Grooving
Parting-off
X4
Adapters Clamping units
Accessories and Spare parts
Workpiece materials

TRGOR/L – Toolholders for inserts RCGS – Inch

TRGOR/L
KAPR = 90,0°

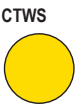
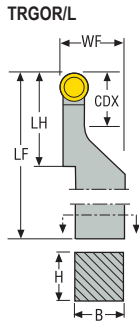
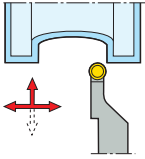

- For inserts program, see page(s) 544, 581
- GAMO° = Rake angle, LAMS° = Inclination angle
- CTWS = Insert shape and size
- For holder code key, see page(s) 17-18
- Right-hand version shown
- Please check availability at www.secotools.com / Seco Online Store

Designation	Item number	H	B	LF	WF	HF	CDX	KAPR°	GAMO°	LAMS°	Weight	CTWS
		Inch	Inch	Inch	Inch	Inch	Inch				lbs	
TRGOR-16-1.5	00041032	1.000	1.000	6.000	1.252	1.000	0.760	90,0	0,0	0,0	1.540	RCGS1.5.
TRGOR-20-1.5	00041040	1.250	1.250	7.000	1.500	1.250	0.760	90,0	0,0	0,0	2.430	RCGS1.5.
TRGOL-16-1.5	00041033	1.000	1.000	6.000	1.250	1.000	0.760	90,0	0,0	0,0	1.540	RCGS1.5.
TRGOL-20-1.5	00041041	1.250	1.250	7.000	1.500	1.250	0.760	90,0	0,0	0,0	2.650	RCGS1.5.
TRGOR-16-2	00041034	1.000	1.000	6.000	1.252	1.000	0.770	90,0	0,0	0,0	1.540	RCGS2.
TRGOR-20-2	00041042	1.250	1.250	7.000	1.500	1.250	0.770	90,0	0,0	0,0	2.870	RCGS2.
TRGOR-24-2	00047814	1.500	1.500	7.000	2.000	1.500	0.770	90,0	0,0	0,0	3.750	RCGS2.
TRGOL-16-2	00041035	1.000	1.000	6.000	1.250	1.000	0.770	90,0	0,0	0,0	1.540	RCGS2.
TRGOL-20-2	00041043	1.250	1.250	7.000	1.500	1.250	0.770	90,0	0,0	0,0	2.650	RCGS2.
TRGOL-24-2	00047815	1.500	1.500	7.000	2.000	1.500	0.770	90,0	0,0	0,0	3.750	RCGS2.
TRGOR-16-3	00041036	1.000	1.000	6.000	1.250	1.000	1.030	90,0	0,0	0,0	1.540	RCGS3.
TRGOR-20-3	00041044	1.250	1.250	7.000	1.500	1.250	1.030	90,0	0,0	0,0	2.650	RCGS3.
TRGOR-24-3	00047816	1.500	1.500	7.000	2.000	1.500	1.030	90,0	0,0	0,0	3.750	RCGS3.
TRGOL-16-3	00041037	1.000	1.000	6.000	1.250	1.000	1.030	90,0	0,0	0,0	1.540	RCGS3.
TRGOL-20-3	00041045	1.250	1.250	7.000	1.500	1.250	1.030	90,0	0,0	0,0	2.650	RCGS3.
TRGOL-24-3	00047817	1.500	1.500	7.000	2.000	1.500	1.030	90,0	0,0	0,0	3.530	RCGS3.
TRGOR-16-4	00041038	1.000	1.000	6.000	1.250	1.000	1.040	90,0	0,0	0,0	1.540	RCGS4.
TRGOR-20-4	00041046	1.250	1.250	7.000	1.500	1.250	1.040	90,0	0,0	0,0	2.870	RCGS4.
TRGOR-24-4	00041048	1.500	1.500	7.000	2.000	1.500	1.040	90,0	0,0	0,0	3.750	RCGS4.
TRGOL-16-4	00041039	1.000	1.000	6.000	1.250	1.000	1.040	90,0	0,0	0,0	1.540	RCGS4.
TRGOL-20-4	00041047	1.250	1.250	7.000	1.500	1.250	1.040	90,0	0,0	0,0	2.650	RCGS4.
TRGOL-24-4	00041049	1.500	1.500	7.000	2.000	1.500	1.040	90,0	0,0	0,0	3.750	RCGS4.

General ISO Turning Holders
Steadyline®
MDT
Mini-Shaft™
Grooving
Parting-off
X4
Adapters Clamping units
Accessories and Spare parts
Workpiece materials

CCLNR/L and CCBNR/L – Toolholders for PCBN inserts CNGN and CNMN – Metric

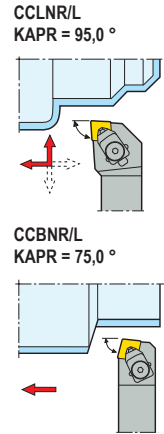
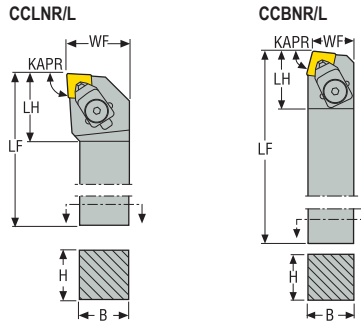

CTWS



- For inserts program, see page(s) 577, 603
- GAMO° = Rake angle, LAMS° = Inclination angle
- CTWS = Insert shape and size
- For holder code key, see page(s) 15-16
- Right-hand version shown
- Please check availability at www.secotools.com / Seco Online Store

Designation	Item number	H	B	LF	WF	LH	KAPR°	GAMO°	LAMS°	Weight	CTWS
		mm	mm	mm	mm	mm				kg	
CCLNR2525M09	00089173	25	25	150	32,0	27,0	95,0	-6,0	-6,0	0,8	CN.N0903..
CCLNR3225P09	00089175	32	25	170	32,0	27,0	95,0	-6,0	-6,0	1,1	CN.N0903..
CCLNL2525M09	00089174	25	25	150	32,0	27,0	95,0	-6,0	-6,0	0,8	CN.N0903..
CCLNL3225P09	00089176	32	25	170	32,0	27,0	95,0	-6,0	-6,0	1,1	CN.N0903..
CCLNR2525M12	00089177	25	25	150	32,0	34,0	95,0	-6,0	-6,0	0,8	CN.N1204..
CCLNR3225P12	00089179	32	25	170	32,0	34,0	95,0	-6,0	-6,0	1,1	CN.N1204..
CCLNL2525M12	00089178	25	25	150	32,0	34,0	95,0	-6,0	-6,0	0,8	CN.N1204..
CCLNL3225P12	00089180	32	25	170	32,0	34,0	95,0	-6,0	-6,0	1,1	CN.N1204..
CCBNR2525M09	00089181	25	25	150	22,0	30,0	75,0	-6,0	-6,0	0,8	CN.N0903..
CCBNL2525M09	00089182	25	25	150	22,0	30,0	75,0	-6,0	-6,0	0,8	CN.N0903..
CCBNR2525M12	00089185	25	25	150	22,0	34,0	75,0	-6,0	-6,0	0,8	CN.N1204..
CCBNR3225P12	00089187	32	25	170	22,0	34,0	75,0	-6,0	-6,0	1,1	CN.N1204..
CCBNL2525M12	00089186	25	25	150	22,0	34,0	75,0	-6,0	-6,0	0,8	CN.N1204..

Spare Parts

For size	Cantilever clamp	Clamp key	Insert shim	Pressure plate	Shim screw
...09	 CC17P-09	 4SMS795	 CCN090412	 P1311-09	 174.10-652-T07P
...12	 CC17P	 4SMS795	 CCN120312	 P1311	 F94009-T09P

Accessories

For size	Shim key
...09	 T07P-2
...12	 T09P-2

CCLNR/L-C – Toolholders for ceramic inserts CNGN – Metric

CCLNR/L-C
KAPR = 95,0°

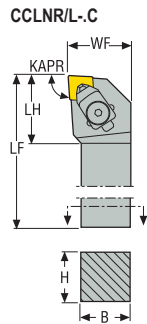
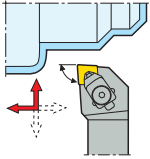

CTWS



- For inserts program, see page(s) 603
- GAMO° = Rake angle, LAMS° = Inclination angle
- CTWS = Insert shape and size
- For holder code key, see page(s) 15-16
- Right-hand version shown
- Please check availability at www.secotools.com / Seco Online Store

Designation	Item number	H	B	LF	WF	LH	KAPR°	GAMO°	LAMS°	Weight	CTWS
		mm	mm	mm	mm	mm				kg	
CCLNR2525M12-4C	02926470	25	25	150	32,4	32,2	95,0	-6,0	-6,0	0,7	CN.N1207..
CCLNL2525M12-4C	02926471	25	25	150	32,4	32,2	95,0	-6,0	-6,0	0,7	CN.N1207..

Spare Parts

For size	Clamp kit	Insert shim	Shim key	Shim screw
..-4C	 CC12P-D12	 DCN120316	 T15P-2D	 C04008-T15P

Accessories

For size	Insert shim
..-4C	 DCN120616

General ISO Turning
Holders

Steadyline®

MDT

Mini-Shaft™

Grooving

Parting-off

X4

Adapters
Clamping units

Accessories and
Spare parts

Workpiece
materials

CDJNR/L and CDNNN – Toolholders for PCBN inserts DNGN and DNMN – Metric

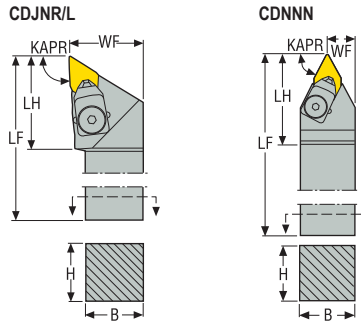
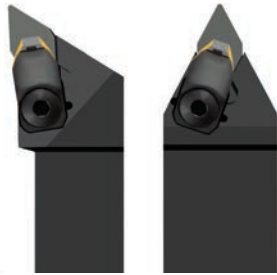

CDJNR/L
KAPR = 93,0 °

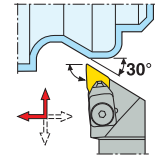

CDNNN
KAPR = 62,5 °

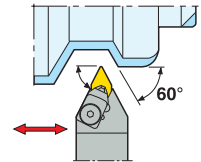





CTWS



- For inserts program, see page(s) 580
- GAMO° = Rake angle, LAMS° = Inclination angle
- CTWS = Insert shape and size
- For holder code key, see page(s) 15-16
- CDJNR/L = Right-hand version shown
- CDNNN = Neutral version shown
- Please check availability at www.secotools.com / Seco Online Store

Designation	Item number	H	B	LF	WF	LH	KAPR°	GAMO°	LAMS°	Weight	CTWS
		mm	mm	mm	mm	mm				kg	
CDJNR2525M11	00089189	25	25	150	32,0	34,0	93,0	-6,0	-6,0	0,8	DN.N1103..
CDJNR3225P11	00089191	32	25	170	32,0	34,0	93,0	-6,0	-6,0	1,1	DN.N1103..
CDJNL2525M11	00089190	25	25	150	32,0	34,0	93,0	-6,0	-6,0	0,8	DN.N1103..
CDJNL3225P11	00089192	32	25	170	32,0	34,0	93,0	-6,0	-6,0	1,1	DN.N1103..
CDNNN2525M11	00089193	25	25	150	13,2	30,0	62,5	-9,0	-5,0	0,7	DN.N1103..
CDNNN3225P11	00089194	32	25	170	13,2	30,0	62,5	0,0	-5,0	1,1	DN.N1103..

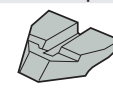
Spare Parts

For size	Cantilever clamp	Clamp key	Insert shim	Pressure plate	Shim screw
...11	 CC20P	 4SMS795	 CDN110412	 P1311-09	 174.10-652-T07P

Accessories

For size	Shim key
...11	 T07P-2

General ISO Turning Holders
Steadyline®
MDT
Mini-Shaft™
Grooving
Parting-off
X4
Adapters Clamping units
Accessories and Spare parts
Workpiece materials

CRDCR...C and CRDCN...C – Toolholders for ceramic inserts RCGX and RPGX – Metric

CRDCR/L...C
KAPR = 0,0 °

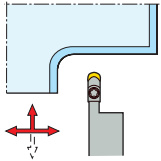

CRDCN...C
KAPR = 0,0 °

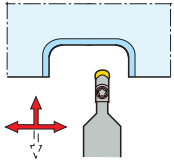

CRDCR/L...C

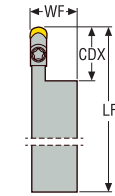

CRDCN...C

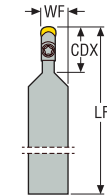





CTWS



- For inserts program, see page(s) 603, 605
- GAMO° = Rake angle, LAMS° = Inclination angle
- CTWS = Insert shape and size
- For holder code key, see page(s) 15-16
- For information regarding clamp screw, contact your local Seco office
- CRDCR...C = Right-hand version shown
- CRDCN...C = Neutral version shown
- Please check availability at www.secotools.com / Seco Online Store

Designation	Item number	H	B	LF	WF	LH	CDX	KAPR°	GAMO°	LAMS°	Weight	CTWS
		mm	mm	mm	mm	mm	mm				kg	
CRDCR3225P09C	02926480	32	25	170	25,98	29,0	29,5	0,0	0,0	0,0	0,9	R.GX0907..
CRDCN3225P06C	02926478	32	25	170	15,6	-	19,4	0,0	0,0	0,0	0,9	R.GX0606..
CRDCN3225P09C	02926479	32	25	170	17,2	-	29,0	0,0	0,0	0,0	0,9	R.GX0907..
CRDCN3225P12C	02926482	32	25	170	18,8	-	38,5	0,0	0,0	0,0	0,9	R.GX1207..

Spare Parts

For size	Clamp	Clamp key	Insert shim	Shim key
				
CRDCR...09C	CEN087	-	CN76.206	T10P-2D
CRDCN...06C	CEN055	T30P-7	CN52.190	2SMS795
CRDCN...09C	CEN087	-	CN76.206	T10P-2D
CRDCN...12C	CEN120	T30P-7	CN55.222	T25P-7

CRDNN – Toolholders for PCBN inserts RGN and RNMN – Inch

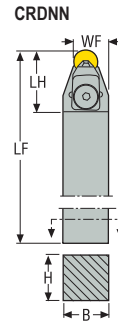

CTWS



- For inserts program, see page(s) 582, 601, 604
- GAMO° = Rake angle, LAMS° = Inclination angle
- CTWS = Insert shape and size
- For holder code key, see page(s) 17-18
- Shim 117.10-621 for insert RN.N43., to be ordered separately
- Neutral version shown
- Please check availability at www.secotools.com / Seco Online Store

Designation	Item number	H	B	LF	WF	LH	KAPR°	GAMO°	LAMS°	Weight	CTWS
		Inch	Inch	Inch	Inch	Inch				lbs	
CRDNN-16-2	00073874	1.000	1.000	6.000	0.750	1.270	45,0	0,0	-7,0	1.760	RN..22.
CRDNN-20-3	00073878	1.250	1.250	6.000	0.875	1.197	45,0	0,0	-7,0	2.650	RN..32.
CRDNN-20-4	00073880	1.250	1.250	6.000	0.875	1.693	45,0	0,0	-7,0	2.870	RN..42.

Spare Parts

For size	Cantilever clamp	Clamp key	Insert shim	Pressure plate	Shim key	Shim screw
..-2	 CC17P-06	 4SMS795	 CRN0603M0	 P1311-06	 T07P-2	 CS2507-T07P
..-3	 CC17P-09	 4SMS795	 117.10-620	 P1311-09	 T07P-2	 174.10-652-T07P
..-4	 CC17P	 4SMS795	 117.10-622	 P1311	 T09P-2	 F94009-T09P

CRGNR/L – Toolholders for PCBN inserts RNGN and RNMN – Inch

CRGNR/L
KAPR = 90,0°

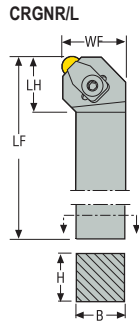
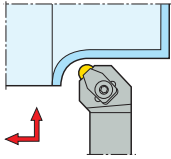





CTWS



- For inserts program, see page(s) 582, 600, 604
- GAMO° = Rake angle, LAMS° = Inclination angle
- CTWS = Insert shape and size
- For holder code key, see page(s) 17-18
- Shim 117.10-621 for insert RN.N43..., to be ordered separately
- Right-hand version shown
- Please check availability at www.secotools.com / Seco Online Store

Designation	Item number	H	B	LF	WF	LH	KAPR°	GAMO°	LAMS°	Weight	CTWS
		Inch	Inch	Inch	Inch	Inch				lbs	
CRGNR-20-4	00073898	1.250	1.250	6.000	1.500	1.382	90,0	-5,0	-5,0	2.870	RN..42.
CRGNL-20-4	00073909	1.250	1.250	6.000	1.500	1.382	90,0	-5,0	-5,0	3.090	RN..42.

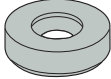
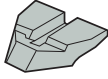
Spare Parts

For size	Cantilever clamp	Clamp key	Insert shim	Pressure plate	Shim screw
..-4	 CC17P	 4SMS795	 117.10-622	 P1311	 F94009-T09P

Accessories

For size	Shim key
..-4	 T09P-2

General ISO Turning
Holders

Steadyline®

MDT

Mini-Shaft™

Grooving

Parting-off

X4

Adapters
Clamping units

Accessories and
Spare parts

Workpiece
materials

CRSNR/L and CRDNN – Toolholders for PCBN inserts RNGN and RNMN – Metric

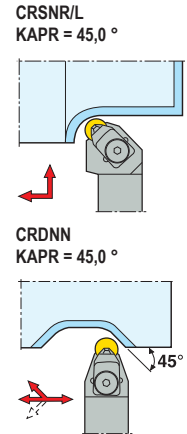
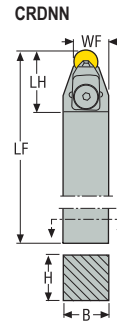
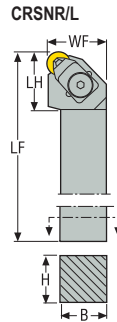

CTWS



- For inserts program, see page(s) 582, 601, 604
- GAMO° = Rake angle, LAMS° = Inclination angle
- CTWS = Insert shape and size
- For holder code key, see page(s) 15-16
- Shim 117.10-621 for insert RN.N1204.., to be ordered separately
- CRSNR/L = Right-hand version shown
- CRDNN = Neutral version shown
- Please check availability at www.secotools.com / Seco Online Store

Designation	Item number	H	B	LF	WF	LH	KAPR°	GAMO°	LAMS°	Weight	CTWS
		mm	mm	mm	mm	mm				kg	
CRSNR2525M06	75069238	25	25	150	32,0	27,0	45,0	-6,0	-6,0	0,8	RN.N0603..
CRSNL2525M06	75069239	25	25	150	32,0	27,0	45,0	-6,0	-6,0	0,8	RN.N0603..
CRSNR2525M09	00089195	25	25	150	32,0	29,0	45,0	-6,0	-6,0	0,8	RN.N0903..
CRSNR3225P09	00089197	32	25	170	32,0	29,0	45,0	-6,0	-6,0	1,1	RN.N0903..
CRSNR4040R09	02424441	40	40	200	50,0	29,0	45,0	-6,0	-6,0	2,5	RN.N0903..
CRSNL2525M09	00089196	25	25	150	32,0	29,0	45,0	-6,0	-6,0	0,8	RN.N0903..
CRSNL3225P09	00089198	32	25	170	32,0	29,0	45,0	-6,0	-6,0	1,1	RN.N0903..
CRSNL4040R09	02424439	40	40	200	50,0	29,0	45,0	-6,0	-6,0	2,5	RN.N0903..
CRSNR3225P12	00089199	32	25	170	32,0	30,0	45,0	-6,0	-6,0	1,1	RN.N1203..
CRSNR4040R12	02424442	40	40	200	50,0	30,0	45,0	-6,0	-6,0	2,5	RN.N1203..
CRSNL3225P12	00089200	32	25	170	32,0	30,0	45,0	-6,0	-6,0	1,1	RN.N1203..
CRSNL4040R12	02424440	40	40	200	50,0	30,0	45,0	-6,0	-6,0	2,5	RN.N1203..
CRDNN2525M06	75069237	25	25	150	15,5	29,0	45,0	0,0	-8,0	0,7	RN.N0603..
CRDNN3225P09	00089201	32	25	170	17,0	31,0	45,0	0,0	-8,0	1,0	RN.N0603..
CRDNN4040R09	02424437	40	40	200	24,8	31,0	45,0	0,0	-8,0	2,3	RN.N0903..
CRDNN3225P12	00089202	32	25	170	18,5	36,0	45,0	0,0	-8,0	1,1	RN.N1203..
CRDNN4040R12	02424438	40	40	200	26,3	36,0	45,0	0,0	-8,0	2,3	RN.N1203..
CRDNN5040T12	75069265	50	40	300	26,3	36,0	45,0	0,0	-8,0	4,4	RN.N1203..

Spare Parts

For size	Cantilever clamp	Clamp key	Insert shim	Pressure plate	Shim screw
...06	 CC17P-06	 4SMS795	 CRN0603M0	 P1311-06	 CS2507-T07P
...09	CC17P-09	4SMS795	117.10-620	P1311-09	174.10-652-T07P
...12	CC17P	4SMS795	117.10-622	P1311	F94009-T09P

Accessories

For size	Shim key
...06	T07P-2
...09	T07P-2
...12	T09P-2



- General ISO Turning Holders
- Steadyline®
- MDT
- Mini-Shaft™
- Grooving
- Parting-off
- X4
- Adapters Clamping units
- Accessories and Spare parts
- Workpiece materials

CRSNR/L...C and CRDNN...C – Toolholders for ceramic inserts RNGN – Metric

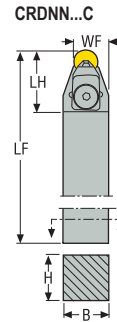
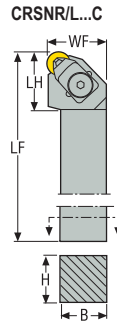

CRSNR/L...C
KAPR = 0,0°

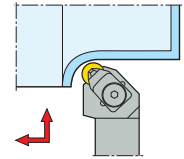

CRDNN...C
KAPR = 0,0°

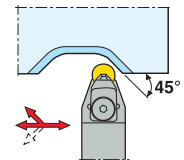

CTWS



- For inserts program, see page(s) 582, 601, 604
- GAMO° = Rake angle, LAMS° = Inclination angle
- CTWS = Insert shape and size
- For holder code key, see page(s) 15-16
- CRSNR/L...C = Right-hand version shown
- CRDNN...C = Neutral version shown
- Please check availability at www.secotools.com / Seco Online Store

Designation	Item number	H	B	LF	WF	LH	KAPR°	GAMO°	LAMS°	Weight	CTWS
		mm	mm	mm	mm	mm				kg	
CRSNR2525M12C	02926488	25	25	150	32,0	28,0	0,0	-6,0	-6,0	0,7	RNGN1207..
CRSNR3225P12C	02926490	32	25	170	32,0	28,0	0,0	-6,0	-6,0	1,1	RNGN1207..
CRSNL2525M12C	02926489	25	25	150	32,0	28,0	0,0	-6,0	-6,0	0,7	RNGN1207..
CRSNL3225P12C	02926491	32	25	170	32,0	28,0	0,0	-6,0	-6,0	1,1	RNGN1207..
CRDNN2525M12C	02926486	25	25	150	18,8	32,0	0,0	0,0	0,0	0,7	RNGN1207..

Spare Parts

For size	Clamp	Clamp key	Insert shim	Pressure plate	Shim key	Shim screw
..12C	CC17P	4SMS795	CRN120400	P1311	T20P-2D	L85013-T20P

Accessories

For size	Insert shim
..12C	CRN120800

General ISO Turning Holders
Steadyline®
MDT
Mini-Shaft™
Grooving
Parting-off
X4
Adapters Clamping units
Accessories and Spare parts
Workpiece materials

CSBNR/L and CSRNR/L – Toolholders for PCBN inserts SNGN, SNMN and SNUN – Metric

CSBNR/L
KAPR = 75,0°

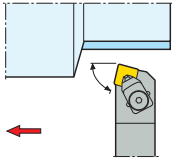

CSRNR/L
KAPR = 75,0°

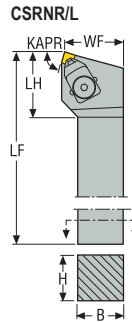
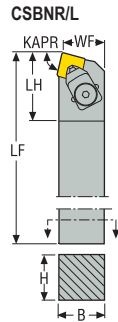
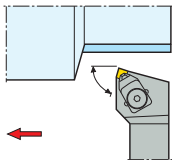











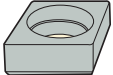
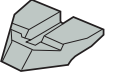

CTWS



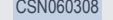
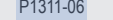

- For inserts program, see page(s) 587
- GAMO° = Rake angle, LAMS° = Inclination angle
- CTWS = Insert shape and size
- For holder code key, see page(s) 15-16
- Shim 174.10-622 for insert SN.N1203..., to be ordered separately
- Right-hand version shown
- Please check availability at www.secotools.com / Seco Online Store

Designation	Item number	H	B	LF	WF	LH	KAPR°	GAMO°	LAMS°	Weight	CTWS
		mm	mm	mm	mm	mm				kg	
CSBNR2525M09	00089203	25	25	150	22,0	30,0	75,0	-6,0	-6,0	0,8	SN.N0903..
CSBNR3225P09	00089206	32	25	170	22,0	30,0	75,0	-6,0	-6,0	1,1	SN.N0903..
CSBNL2525M09	00089204	25	25	150	22,0	30,0	75,0	-6,0	-6,0	0,8	SN.N0903..
CSBNR3225P12	00089207	32	25	170	22,0	35,0	75,0	-6,0	-6,0	1,1	SN.N1204..
CSBNL3225P12	00089208	32	25	170	22,0	35,0	75,0	-6,0	-6,0	1,1	SN.N1204..
CSRNR2525M06	00005868	25	25	150	32,0	35,0	75,0	-6,0	-6,0	0,8	SN.N0603..
CSRNL2525M06	00005867	25	25	150	32,0	30,0	75,0	-6,0	-6,0	0,8	SN.N0603..

Spare Parts

For size	Cantilever clamp	Clamp key	Insert shim	Pressure plate	Shim screw
...09	 CC17P-09	 4SMS795	 CSN090412	 P1311-09	 174.10-652-T07P
...P12	 CC20P	 4SMS795	 174.10-621	 P1311	 F94009-T09P
...06	 CC17P-06	 4SMS795	 CSN060308	 P1311-06	 CS2507-T07P

Accessories

For size	Shim key
...09	 T07P-2
...P12	 T09P-2
...06	 T07P-2

CSDNN and CSKNR/L – Toolholders for PCBN inserts SNGN, SNMN and SNUN – Metric

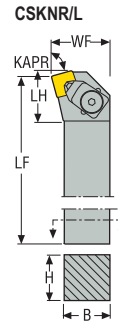
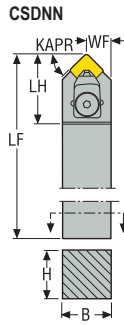

CSDNN
KAPR = 45,0 °

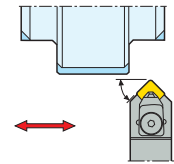

CSKNR/L
KAPR = 75,0 °

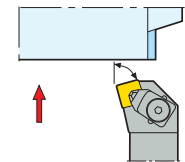

CTWS



- For inserts program, see page(s) 586
- GAMO° = Rake angle, LAMS° = Inclination angle
- CTWS = Insert shape and size
- For holder code key, see page(s) 15-16
- Shim 174.10-622 for insert SN.N1203..., to be ordered separately
- CSDNN = Neutral version shown
- CSKNR/L = Right-hand version shown
- Please check availability at www.secotools.com / Seco Online Store

Designation	Item number	H	B	LF	WF	LH	KAPR°	GAMO°	LAMS°	Weight	CTWS
		mm	mm	mm	mm	mm				kg	
CSDNN3225P09	00089209	32	25	170	13,0	33,0	45,0	-6,0	-6,0	1,1	SN.N0903..
CSDNN3225P12	00089210	32	25	170	13,0	40,0	45,0	-6,0	-6,0	1,1	SN.N1204..
CSDNN4040R12	02424446	40	40	200	20,3	40,0	45,0	-6,0	-6,0	2,4	SN.N1204..
CSKNR2525M06	00005872	25	25	150	32,0	35,0	75,0	-6,0	-6,0	0,8	SN.N0603..
CSKNL2525M06	00005871	25	25	150	32,0	35,0	75,0	-6,0	-6,0	0,8	SN.N0603..
CSKNR3225P12	00089211	32	25	170	32,0	36,0	75,0	-6,0	-6,0	1,2	SN.N1204..
CSKNR4040R12	02424470	40	40	200	50,0	36,0	75,0	-6,0	-6,0	2,5	SN.N1204..
CSKNL3225P12	00089212	32	25	170	32,0	36,0	75,0	-6,0	-6,0	1,2	SN.N1204..

Spare Parts

For size	Cantilever clamp	Clamp key	Insert shim	Pressure plate	Shim screw
...09	 CC17P-09	 4SMS795	 CSN090412	 P1311-09	 174.10-652-T07P
...12	CC20P	4SMS795	174.10-621	P1311	F94009-T09P
...06	CC17P-06	4SMS795	CSN060308	P1311-06	CS2507-T07P

Accessories

For size	Shim key
...09	 T07P-2
...12	T09P-2
...06	T07P-2

General ISO Turning Holders
Steadyline®
MDT
Mini-Shaft™
Grooving
Parting-off
X4
Adapters Clamping units
Accessories and Spare parts
Workpiece materials

CSDNN – Toolholders for PCBN inserts SNGN and SNMN – Inch

CSDNN
KAPR = 45,0°

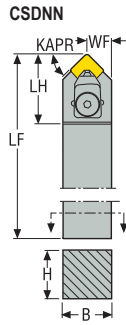
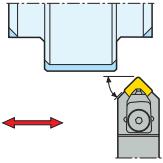

CTWS



- For inserts program, see page(s) 586
- GAMO° = Rake angle, LAMS° = Inclination angle
- CTWS = Insert shape and size
- For holder code key, see page(s) 17-18
- Shim 174.10-622 for insert SN.N1203..., to be ordered separately
- CSDNN = Neutral version shown
- CSKNR/L = Right-hand version shown
- Please check availability at www.secotools.com / Seco Online Store

Designation	Item number	H	B	LF	WF	LH	KAPR°	GAMO°	LAMS°	Weight	CTWS
		Inch	Inch	Inch	Inch	Inch				lbs	
CSDNN-16-4	00073786	1.000	1.000	6.000	0.500	1.701	45,0	0,0	-7,0	1.760	SNMN423S

Spare Parts

For size	Cantilever clamp	Clamp key	Insert shim	Pressure plate	Shim screw
..-4	 CC20P	 4SMS795	 174.10-622	 P1311	 F94009-T09P

Accessories

For size	Shim key
..-4	 T09P-2

General ISO Turning
Holders

Steadyline®

MDT

Mini-Shaft™

Grooving

Parting-off

X4

Adapters
Clamping units

Accessories and
Spare parts

Workpiece
materials

CSSNR/L – Toolholders for PCBN inserts SNGN and SNMN – Metric

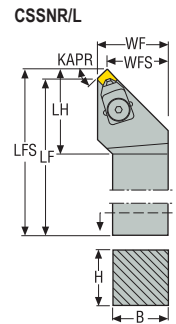

CSSNR/L
KAPR = 45,0 °

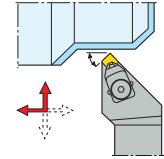

CTWS



- For inserts program, see page(s) 586
- GAMO° = Rake angle, LAMS° = Inclination angle
- CTWS = Insert shape and size
- For holder code key, see page(s) 15-16
- Right-hand version shown
- Please check availability at www.secotools.com / Seco Online Store

Designation	Item number	H	B	LF	LFS	WF	WFS	LH	KAPR°	GAMO°	LAMS°	Weight	CTWS
		mm	mm	mm	mm	mm	mm	mm				kg	
CSSNR2525M06	00005870	25	25	150	154,2	32,2	27,8	27,0	45,0	-7,0	0,0	0,8	SN.N0603..
CSSNL2525M06	00005869	25	25	150	154,2	32,2	27,8	27,0	45,0	-7,0	0,0	0,8	SN.N0603..

Spare Parts

For size	Cantilever clamp	Clamp key	Insert shim	Pressure plate	Shim screw
...06	 CC17P-06	 4SMS795	 CSN060308	 P1311-06	 CS2507-T07P

Accessories

For size	Shim key
...06	 T07P-2

General ISO Turning Holders
Steadyline®
MDT
Mini-Shaft™
Grooving
Parting-off
X4
Adapters Clamping units
Accessories and Spare parts
Workpiece materials

CTGNR/L...-PL – Toolholders for PCBN inserts TNGN and TNMN – Metric

CTGNR/L...-PL
KAPR = 90,0°

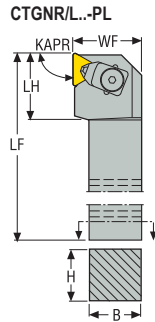
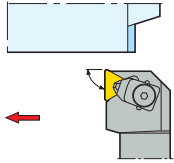

- For inserts program, see page(s) 591, 592
- GAMO° = Rake angle, LAMS° = Inclination angle
- CTWS = Insert shape and size
- For holder code key, see page(s) 15-16
- Right-hand version shown
- Please check availability at www.secotools.com / Seco Online Store

Designation	Item number	H	B	LF	WF	LH	KAPR°	GAMO°	LAMS°	Weight	CTWS
		mm	mm	mm	mm	mm				kg	
CTGNR3225P11-PL	00042808	32	25	170	32,2	31,0	90,0	-8,0	0,0	1,1	TN.N1103..
CTGNL3225P11-PL	00042809	32	25	170	32,2	31,0	90,0	-8,0	0,0	1,1	TN.N1103..

Spare Parts

For size	Cantilever clamp	Clamp key	Insert shim	Pressure plate	Setting screw	Shim screw
...11	 CC17P-06	 4SMS795	 CTN110308	 P1311-06	 179.17-686	 CS2507-T07P

Accessories

For size	Shim key
...11	 T07P-2

General ISO Turning
Holders

Steadyline®

MDT

Mini-Shaft™

Grooving

Parting-off

X4

Adapters
Clamping units

Accessories and
Spare parts

Workpiece
materials

CTJNR/L and CTFNR/L – Toolholders for PCBN inserts TNGN, TNGX, TNMN and TNMX – Metric

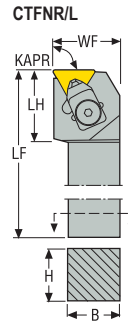
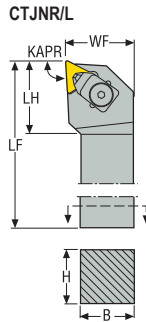
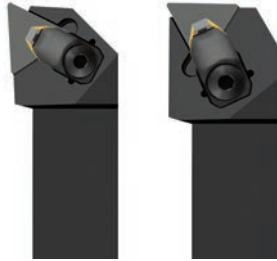

CTJNR/L
KAPR = 93,0 °

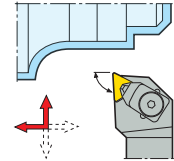

CTFNR/L
KAPR = 91,0 °

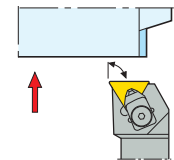

CTWS



- For inserts program, see page(s) 558, 559, 560, 561, 591
- GAMO° = Rake angle, LAMS° = Inclination angle
- CTWS = Insert shape and size
- For holder code key, see page(s) 15-16
- Shim CTN110312 for insert TN.N110312 and TNMX110308S-WZ, to be ordered separately
- Shim 175.10-622 for insert TNGN1603.., to be ordered separately
- Right-hand version shown
- Please check availability at www.secotools.com / Seco Online Store

Designation	Item number	H	B	LF	WF	LH	KAPR°	GAMO°	LAMS°	Weight	CTWS
		mm	mm	mm	mm	mm				kg	
CTJNR2525M11	75069262	25	25	150	32,2	23,0	93,0	-6,0	-6,0	0,8	TN.N/TN.X1103..
CTJNL2525M11	75069263	25	25	150	32,2	23,0	93,0	-6,0	-6,0	0,8	TN.N/TN.X1103..
CTJNR2525M16	00095796	25	25	150	32,2	35,0	93,0	-6,0	-6,0	0,8	TN.N1604..
CTJNL2525M16	00095797	25	25	150	32,2	35,0	93,0	-6,0	-6,0	0,8	TN.N1604..
CTFNR2525M11	75069266	25	25	150	32,2	29,3	91,0	-6,0	-6,0	0,8	TN.N/TN.X1103..
CTFNL2525M11	75069267	25	25	150	32,2	29,3	91,0	-6,0	-6,0	0,8	TN.N/TN.X1103..
CTFNR2525M16	00095792	25	25	150	32,2	35,0	91,0	-6,0	-6,0	0,8	TN.N1604..

Spare Parts

For size	Cantilever clamp	Clamp key	Insert shim	Pressure plate	Shim screw
...11	 CC17P-06	 4SMS795	 CTN110308	 P1311-06	 CS2507-T07P
...16	CC17P-09	4SMS795	175.10-621	P1311-09	F94009-T09P

Accessories

For size	Shim key
...11	 T07P-2
...16	T09P-2

CTJNR/L and CTFNR/L – Toolholders for PCBN inserts TNGN, TNMN and TNMX – Inch

CTJNR/L
KAPR = 93,0°

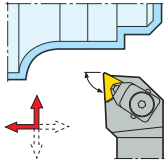



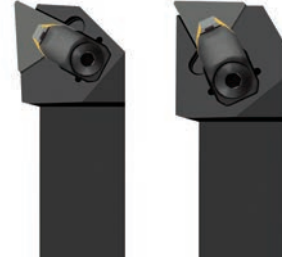
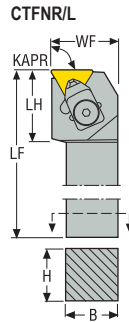
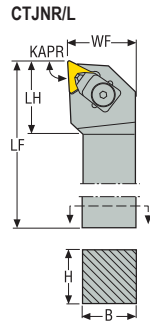
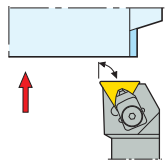

CTJNR/L
KAPR = 90,0°



- For inserts program, see page(s) 558, 559, 560, 561, 591, 592
- GAMO° = Rake angle, LAMS° = Inclination angle
- CTWS = Insert shape and size
- For holder code key, see page(s) 17-18
- TNMX insert for CTJNR/L toolholder KAPR = 93°
- Shim CTN110312 for insert TNMN223, to be ordered separately
- Right-hand version shown
- Please check availability at www.secotools.com / Seco Online Store

Designation	Item number	H	B	LF	WF	LH	KAPR°	GAMO°	LAMS°	Weight	CTWS
		Inch	Inch	Inch	Inch	Inch				lbs	
CTJNR-16-2	00073868	1.000	1.000	6.000	1.250	1.181	93,0	-6,0	-6,0	1.980	TN..22.
CTJNL-16-2	00073871	1.000	1.000	6.000	1.250	1.181	93,0	-6,0	-6,0	1.980	TN..22.
CTFNR-16-2	00073861	1.000	1.000	6.024	1.252	1.181	90,0	-6,0	-6,0	1.980	TN..22.
CTFNL-16-2	00073863	1.000	1.000	6.024	1.252	1.181	90,0	-6,0	-6,0	1.980	TN..22.

Spare Parts

For size	Cantilever clamp	Clamp key	Insert shim	Shim screw
..-2	 CC16	 4SMS795	 CTN110308	 CS2507-T07P

Accessories

For size	Shim key
..-2	 T07P-2

General ISO Turning Holders
Steadyline®
MDT
Mini-Shaft™
Grooving
Parting-off
X4
Adapters Clamping units
Accessories and Spare parts
Workpiece materials

CVVNN – Toolholders for PCBN inserts VNGA and VNMA – Metric

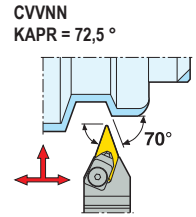
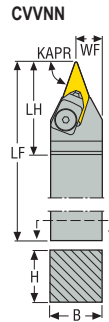





CTWS



- For inserts program, see page(s) 565, 566, 595
- GAMO° = Rake angle, LAMS° = Inclination angle
- CTWS = Insert shape and size
- For holder code key, see page(s) 15-16
- Neutral version shown
- Please check availability at www.secotools.com / Seco Online Store

Designation	Item number	H	B	LF	WF	LH	KAPR°	GAMO°	LAMS°	Weight	CTWS
		mm	mm	mm	mm	mm				kg	
CVVNN3225P16	00094012	32	25	170	13,1	42,0	72,5	-15,0	-5,0	1,0	VN.A1604..

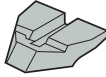
Spare Parts

For size	Cantilever clamp	Clamp key	Insert shim	Pressure plate	Shim pin
...16	 CC20P	 4SMS795	 VSN160316	 P1311-09	 MN0909L-T09P

Accessories

For size	Shim key
...16	 T09P-2

General ISO Turning Holders
Steadyline®
MDT
Mini-Shaft™
Grooving
Parting-off
X4
Adapters Clamping units
Accessories and Spare parts
Workpiece materials

DSBNR/L..-C and DSSNR/L..-C – Toolholders for PCBN inserts SNGA – Metric

DSBNR/L..-C
KAPR = 75,0°

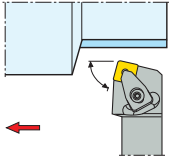

DSSNR/L..-C
KAPR = 45,0°

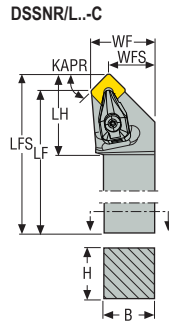
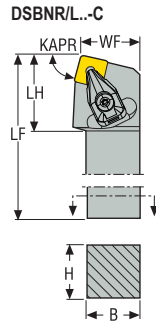
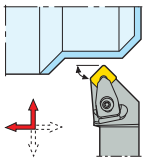







CTWS







- For inserts program, see page(s) 585
- GAMO° = Rake angle, LAMS° = Inclination angle
- CTWS = Insert shape and size
- For holder code key, see page(s) 15-16
- Right-hand version shown
- Please check availability at www.secotools.com / Seco Online Store

Designation	Item number	H	B	LF	LFS	WF	WFS	LH	KAPR°	GAMO°	LAMS°	Weight	CTWS
		mm	mm	mm	mm	mm	mm	mm				kg	
DSBNR3225P12-C	02598526	32	25	170	-	32,0	-	35,0	75,0	-6,0	-6,0	1,1	SN.A1204..
DSBNL3225P12-C	02598527	32	25	170	-	32,0	-	35,0	75,0	-6,0	-6,0	1,1	SN.A1204..
DSSNR3225P12-C	02598529	32	25	170	179,1	32,0	23,9	39,0	45,0	-8,0	0,0	1,1	SN.A1204..
DSSNL3225P12-C	02598530	32	25	170	179,1	32,0	23,9	39,0	45,0	-8,0	0,0	1,1	SN.A1204..

Spare Parts

For size	Clamp pin	Clamp screw	Floating wedge clamp	Insert shim	Shim/clamp key	Shim screw	Spring
...12	 FP2012	 L85021-T15P	 CC12P-S12	 DSN120616	 T15P-2	 C04008-T15P	 S6912

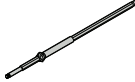
Accessories

For size	Clamp kit	Insert clamping torque	Replacement blade	Torque key
...12	 CC12P-SET	 3.5NM	 T00-15P	 T00-15P35

General ISO Turning
Holders

Steadyline®

MDT

Mini-Shaft™

Grooving

Parting-off

X4

Adapters
Clamping units

Accessories and
Spare parts

Workpiece
materials

DWLNR/L..-C – Toolholders for PCBN inserts WNGA and WNMA – Metric

General ISO Turning
Holders

Steadyline®

MDT

Mini-Shaft™

Grooving

Parting-off

X4

Adapters
Clamping units

Accessories and
Spare parts

Workpiece
materials

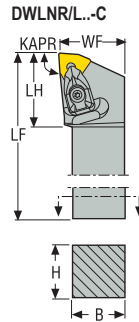

DWLNR/L..-C
KAPR = 95,0 °

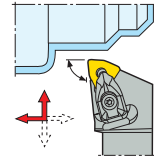

CTWS



- For inserts program, see page(s) 568, 569, 570, 571, 596
- GAMO° = Rake angle, LAMS° = Inclination angle
- CTWS = Insert shape and size
- For holder code key, see page(s) 15-16
- Right-hand version shown
- * Use the right shim & the right screw for the selected insert. For details, see page 99
- Please check availability at www.secotools.com / Seco Online Store

Designation	Item number	H	B	LF	WF	LH	KAPR°	GAMO°	LAMS°	Weight	CTWS
		mm	mm	mm	mm	mm				kg	
DWLNR3225P06-C	02598535	32	25	170	32,0	32,0	95,0	-6,0	-6,0	1,1	WN.A0604..
DWLNR3225P08-C	02598537	32	25	170	32,0	35,0	95,0	-6,0	-6,0	1,1	WN..0804/WN..0806*

Spare Parts

For size	Clamp pin	Clamp screw	Floating wedge clamp	Insert shim	Shim/clamp key	Shim screw	Spring
...06	FP1508	L84017-T09P	CC09P-D11	DWN060310	T09P-2	C03007-T09P	S5608
...08	FP2012	L85021-T15P	CC12P-S12	DWN080416	T15P-2	C04008-T15P	S6912

Accessories

For size	Clamp kit	Insert clamping torque	Replacement blade	Torque key
...06	CC09P-SET	2.0NM	T00-09P	T00-09P20
...08	CC12P-SET	3.5NM	T00-15P	T00-15P35

C.-PCLNR/L – Toolholders for inserts CNGG, CNGM, CNMA, CNMG and CNMM – Metric / Inch

C.-PCLNR/L
KAPR = 95,0 °

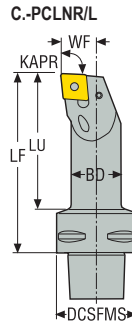
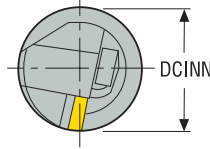
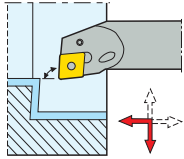

CTWS



- For inserts program, see page(s) 527, 528, 529, 530, 531, 532, 533, 597
- GAMO° = Rake angle, LAMS° = Inclination angle
- CTMS = Seco-Capto™ size
- CTWS = Insert shape and size
- For holder code key, see page(s) 13-14
- Right-hand version shown
- Please check availability at www.secotools.com / Seco Online Store

Designation	Item number	CTMS	BD	DCSFMS	WF	LF	LU	DCINN	KAPR°	GAMO°	LAMS°	Weight	CTWS
			mm Inch	mm Inch	mm Inch	mm Inch	mm Inch	mm Inch					
C4-PCLNR-17090-12	00084497	C4	25,0 0.984	40,0 1.575	17,0 0.669	90,0 3.543	69,0 2.717	32,0 1.260	95,0	-6,0	-11,0	0,5 1.100	CN..1204.. CN..43.
C4-PCLNR-22110-12	00084499	C4	32,0 1.260	40,0 1.575	22,0 0.866	110,0 4.331	89,0 3.504	40,0 1.575	95,0	-6,0	-11,0	0,8 1.760	CN..1204.. CN..43.
C4-PCLNR-27080-12	00009356	C4	40,0 1.575	40,0 1.575	27,0 1.063	80,0 3.150	60,0 2.362	50,0 1.969	95,0	-6,0	-10,0	0,7 1.540	CN..1204.. CN..43.
C4-PCLNR-27120-12	00009358	C4	40,0 1.575	40,0 1.575	27,0 1.063	120,0 4.724	100,0 3.937	50,0 1.969	95,0	-6,0	-11,0	1,1 2.430	CN..1204.. CN..43.
C4-PCLNL-17090-12	00084498	C4	25,0 0.984	40,0 1.575	17,0 0.669	90,0 3.543	69,0 2.717	32,0 1.260	95,0	-6,0	-11,0	0,5 1.100	CN..1204.. CN..43.
C4-PCLNL-22110-12	00084500	C4	32,0 1.260	40,0 1.575	22,0 0.866	110,0 4.331	89,0 3.504	40,0 1.575	95,0	-6,0	-11,0	0,8 1.760	CN..1204.. CN..43.
C4-PCLNL-27080-12	02589999	C4	40,0 1.575	40,0 1.575	27,0 1.063	80,0 3.150	60,0 2.362	50,0 1.969	95,0	-6,0	-10,0	0,7 1.540	CN..1204.. CN..43.
C5-PCLNR-17090-12	02547669	C5	25,0 0.984	50,0 1.969	17,0 0.669	90,0 3.543	67,0 2.638	32,0 1.260	95,0	-6,0	-11,0	0,7 1.540	CN..1204.. CN..43.
C5-PCLNR-22110-12	00090698	C5	32,0 1.260	50,0 1.969	22,0 0.866	110,0 4.331	88,0 3.465	40,0 1.575	95,0	-6,0	-11,0	1,0 2.200	CN..1204.. CN..43.
C5-PCLNR-27140-12	00733878	C5	40,0 1.575	50,0 1.969	27,0 1.063	140,0 5.512	119,0 4.685	50,0 1.969	95,0	-6,0	-10,0	1,5 3.310	CN..1204.. CN..43.
C5-PCLNR-35100-12	00045797	C5	50,0 1.969	50,0 1.969	35,0 1.378	100,0 3.937	81,0 3.189	50,0 1.969	95,0	-6,0	-7,0	1,4 3.090	CN..1204.. CN..43.
C5-PCLNL-17090-12	00081759	C5	25,0 0.984	50,0 1.969	17,0 0.669	90,0 3.543	67,0 2.638	32,0 1.260	95,0	-6,0	-11,0	0,7 1.540	CN..1204.. CN..43.
C5-PCLNL-22110-12	00081760	C5	32,0 1.260	50,0 1.969	22,0 0.866	110,0 4.331	88,0 3.465	40,0 1.575	95,0	-6,0	-11,0	0,8 1.760	CN..1204.. CN..43.
C5-PCLNL-27140-12	00081761	C5	40,0 1.575	50,0 1.969	27,0 1.063	140,0 5.512	119,0 4.685	50,0 1.969	95,0	-6,0	-10,0	1,5 3.310	CN..1204.. CN..43.
C5-PCLNL-35100-12	00081762	C5	50,0 1.969	50,0 1.969	35,0 1.378	100,0 3.937	81,0 3.189	50,0 1.969	95,0	-6,0	-7,0	1,4 3.090	CN..1204.. CN..43.
C6-PCLNR-17100-12	02426133	C6	25,0 0.984	63,0 2.480	17,0 0.669	100,0 3.937	74,0 2.913	32,0 1.260	95,0	-6,0	-11,0	1,1 2.430	CN..1204.. CN..43.
C6-PCLNR-22110-12	00059036	C6	32,0 1.260	63,0 2.480	22,0 0.866	110,0 4.331	84,0 3.307	40,0 1.575	95,0	-6,0	-11,0	1,3 2.870	CN..1204.. CN..43.
C6-PCLNL-17100-12	02558994	C6	25,0 0.984	63,0 2.480	17,0 0.669	100,0 3.937	74,0 2.913	32,0 1.260	95,0	-6,0	-11,0	1,1 2.430	CN..1204.. CN..43.
C6-PCLNL-22110-12	00058823	C6	32,0 1.260	63,0 2.480	22,0 0.866	110,0 4.331	84,0 3.307	40,0 1.575	95,0	-6,0	-11,0	1,3 2.870	CN..1204.. CN..43.
C6-PCLNR-27140-16	02552832	C6	40,0 1.575	63,0 2.480	27,0 1.063	140,0 5.512	115,0 4.528	50,0 1.969	95,0	-6,0	-11,0	1,8 3.970	CN..1606.. CN..54.
C6-PCLNR-35175-16	02552836	C6	50,0 1.969	63,0 2.480	35,0 1.378	175,0 6.890	152,0 5.984	63,0 2.480	95,0	-6,0	-11,0	2,8 6.170	CN..1606.. CN..54.

General ISO Turning Holders
Steadyline®
MDT
Mini-Shaft™
Grooving
Parting-off
X4
Adapters Clamping units
Accessories and Spare parts
Workpiece materials

General ISO Turning Holders
Steadyline®
MDT
Mini-Shaft™
Grooving
Parting-off
X4
Adapters Clamping units
Accessories and Spare parts
Workpiece materials

Designation	Item number	CTMS	BD	DCSFMS	WF	LF	LU	DCINN	KAPR°	GAMO°	LAMS°	Weight	CTWS
			mm Inch	mm Inch	mm Inch	mm Inch	mm Inch	mm Inch				kg lbs	
C6-PCLNL-27140-16	00070126	C6	40,0 1.575	63,0 2.480	27,0 1.063	140,0 5.512	115,0 4.528	50,0 1.969	95,0	-6,0	-11,0	1,8 3.970	CN..1606.. CN..54.
C6-PCLNL-35175-16	00070128	C6	50,0 1.969	63,0 2.480	35,0 1.378	175,0 6.890	152,0 5.984	63,0 2.480	95,0	-6,0	-11,0	2,8 6.170	CN..1606.. CN..54.

Spare Parts

For size	Insert lever	Insert shim	Lever key	Lever screw	Punch	Shim pin
17090-12	PP4613	-	2.5SMS795	LS0613	-	-
-12	PP4713	PCN120308	3SMS795	LS0818	MP0912	RP6757
-17100-12	PP4613	-	2.5SMS795	LS0613	-	-
-22110-12	PP4713	PCN120308	3SMS795	LS0818	MP0912	RP6757
-16	PP7818	PCN160408	3SMS795	LS0820	MP0912	RP8286

Accessories

For size	Insert clamping torque	Torque key
17090-12	3.0NM	H00-2530
-12	-	-
-17100-12	3.0NM	H00-2530
-22110-12	-	-
-16	-	-

C.-PDUNR/L – Toolholders for inserts DNGA, DNGM, DNMA, DNMG, DNMM and DNMX – Metric/ Inch

C.-PDUNR/L
KAPR = 93,0°

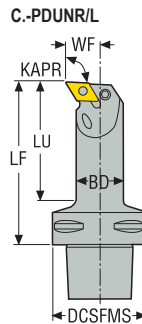
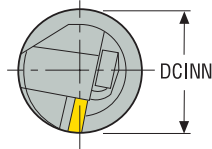
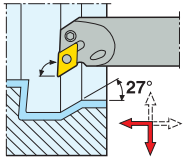

- For inserts program, see page(s) 537, 538, 539, 540, 541, 579, 580
- GAMO° = Rake angle, LAMS° = Inclination angle
- CTMS = Seco-Capto™ size
- CTWS = Insert shape and size
- For holder code key, see page(s) 13-14
- Right-hand version shown
- * Use the right shim & the right screw for the selected insert. For details, see page 99
- Please check availability at www.secotools.com / Seco Online Store

Designation	Item number	CTMS	BD	DCSFMS	WF	LF	LU	DCINN	KAPR°	GAMO°	LAMS°	Weight	CTWS
			mm Inch	mm Inch	mm Inch	mm Inch	mm Inch	mm Inch					
C5-PDUNR-27140-15	00090967	C5	40,0 1.575	50,0 1.969	27,0 1.063	140,0 5.512	119,0 4.685	50,0 1.969	93,0	-6,0	-11,0	1,5 3.310	DN.1504/DN..1506 DN..43/DN..44*
C5-PDUNR-35100-15	02510290	C5	50,0 1.969	50,0 1.969	35,0 1.378	100,0 3.937	81,0 3.189	63,0 2.480	93,0	-6,0	-10,0	1,4 3.090	DN.1504/DN..1506 DN..43/DN..44*
C5-PDUNR-35150-15	00734071	C5	50,0 1.969	50,0 1.969	35,0 1.378	150,0 5.906	131,0 5.157	63,0 2.480	93,0	-6,0	-10,0	2,1 4.630	DN.1504/DN..1506 DN..43/DN..44*
C5-PDUNL-27140-15	02507274	C5	40,0 1.575	50,0 1.969	27,0 1.063	140,0 5.512	119,0 4.685	50,0 1.969	93,0	-6,0	-11,0	1,5 3.310	DN.1504/DN..1506 DN..43/DN..44*
C5-PDUNL-35100-15	02545481	C5	50,0 1.969	50,0 1.969	35,0 1.378	100,0 3.937	81,0 3.189	63,0 2.480	93,0	-6,0	-10,0	1,4 3.090	DN.1504/DN..1506 DN..43/DN..44*
C5-PDUNL-35150-15	02541180	C5	50,0 1.969	50,0 1.969	35,0 1.378	150,0 5.906	131,0 5.157	63,0 2.480	93,0	-6,0	-10,0	2,1 4.630	DN.1504/DN..1506 DN..43/DN..44*
C6-PDUNR-22110-15	02426139	C6	32,0 1.260	63,0 2.480	22,0 0.866	110,0 4.331	84,0 3.307	40,0 1.575	93,0	-6,0	-12,0	1,3 2.870	DN.1504/DN..1506 DN..43/DN..44*
C6-PDUNR-27140-15	02207601	C6	40,0 1.575	63,0 2.480	27,0 1.063	140,0 5.512	115,0 4.528	50,0 1.969	93,0	-6,0	-11,0	1,8 3.970	DN.1504/DN..1506 DN..43/DN..44*
C6-PDUNR-35175-15	02590043	C6	50,0 1.969	63,0 2.480	35,0 1.378	175,0 6.890	152,0 5.984	63,0 2.480	93,0	-6,0	-10,0	2,8 6.170	DN.1504/DN..1506 DN..43/DN..44*
C6-PDUNL-22110-15	02590044	C6	32,0 1.260	63,0 2.480	22,0 0.866	110,0 4.331	84,0 3.307	40,0 1.575	93,0	-6,0	-12,0	1,3 2.870	DN.1504/DN..1506 DN..43/DN..44*
C6-PDUNL-27140-15	02567151	C6	40,0 1.575	63,0 2.480	27,0 1.063	140,0 5.512	115,0 4.528	50,0 1.969	93,0	-6,0	-11,0	1,8 3.970	DN.1504/DN..1506 DN..43/DN..44*
C6-PDUNL-35175-15	02492750	C6	50,0 1.969	63,0 2.480	35,0 1.378	175,0 6.890	152,0 5.984	63,0 2.480	93,0	-6,0	-10,0	2,8 6.170	DN.1504/DN..1506 DN..43/DN..44*

Spare Parts

For size	Insert lever	Insert shim	Lever key	Lever screw	Punch	Shim pin
-15	PP4716	PDN150308	3SMS795	LS0822	MP0912	RP6757

General ISO Turning Holders
Steadyline®
MDT
Mini-Shaft™
Grooving
Parting-off
X4
Adapters Clamping units
Accessories and Spare parts
Workpiece materials

Accessories

For size	Insert shim
-15	 PDN150408

C.-PTFNR/L...W – Toolholders for inserts TNGA, TNMA, TNMG and TNMM – Metric / Inch

C.-PTFNR/L...W
KAPR = 90,0°

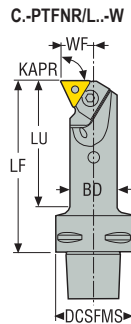
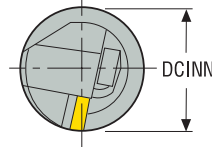
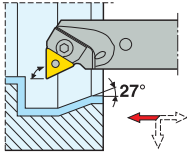

- For inserts program, see page(s) 558, 559, 560, 561, 590
- GAMO° = Rake angle, LAMS° = Inclination angle
- CTMS = Seco-Capto™ size
- CTWS = Insert shape and size
- For holder code key, see page(s) 13-14
- Right-hand version shown
- Please check availability at www.secotools.com / Seco Online Store

Designation	Item number	CTMS	BD	DCSFMS	WF	LF	LU	DCINN	KAPR°	GAMO°	LAMS°	Weight	CTWS
			mm Inch	mm Inch	mm Inch	mm Inch	mm Inch	mm Inch					
C4-PTFNR-17090-16-W	02590007	C4	25,0 0.984	40,0 1.575	17,0 0.669	90,0 3.543	69,0 2.717	32,0 1.260	90,0	-6,0	-13,0	0,5 1.100	TN..1604.. TN..33.
C4-PTFNR-27120-16-W	02590009	C4	40,0 1.575	40,0 1.575	27,0 1.063	120,0 4.724	100,0 3.937	50,0 1.969	90,0	-6,0	-11,0	1,1 2.430	TN..1604.. TN..33.
C4-PTFNL-17090-16-W	02590004	C4	25,0 0.984	40,0 1.575	17,0 0.669	90,0 3.543	69,0 2.717	32,0 1.260	90,0	-6,0	-13,0	0,5 1.100	TN..1604.. TN..33.
C4-PTFNL-27120-16-W	02590006	C4	40,0 1.575	40,0 1.575	27,0 1.063	120,0 4.724	100,0 3.937	50,0 1.969	90,0	-6,0	-11,0	1,1 2.430	TN..1604.. TN..33.
C5-PTFNR-22110-16-W	02590027	C5	32,0 1.260	50,0 1.969	22,0 0.866	110,0 4.331	88,0 3.465	40,0 1.575	90,0	-6,0	-12,0	0,9 1.980	TN..1604.. TN..33.
C5-PTFNR-27140-16-W	02590028	C5	40,0 1.575	50,0 1.969	27,0 1.063	140,0 5.512	119,0 4.685	50,0 1.969	90,0	-6,0	-11,0	1,5 3.310	TN..1604.. TN..33.
C5-PTFNL-22110-16-W	02590031	C5	32,0 1.260	50,0 1.969	22,0 0.866	110,0 4.331	88,0 3.465	40,0 1.575	90,0	-6,0	-12,0	0,9 1.980	TN..1604.. TN..33.
C5-PTFNL-27140-16-W	02590032	C5	40,0 1.575	50,0 1.969	27,0 1.063	140,0 5.512	119,0 4.685	50,0 1.969	90,0	-6,0	-11,0	1,5 3.310	TN..1604.. TN..33.
C6-PTFNR-27140-16-W	02590046	C6	40,0 1.575	63,0 2.480	27,0 1.063	140,0 5.512	115,0 4.528	50,0 1.969	90,0	-6,0	-11,0	1,8 3.970	TN..1604.. TN..33.
C6-PTFNL-27140-16-W	02590050	C6	40,0 1.575	63,0 2.480	27,0 1.063	140,0 5.512	115,0 4.528	50,0 1.969	90,0	-6,0	-11,0	1,8 3.970	TN..1604.. TN..33.

Spare Parts

For size	Insert shim	Setting screw	Shim pin	Wedge clamp	Wedge key
-17...-16	-	F83060-T09P	PL1003	CP16-H31	3SMS795
-22/27...-16	PTN160308	F83060-T09P	PL1203	CP16-H3	3SMS795

Accessories

For size	Insert clamping torque	Replacement blade	Shim key	Torque key
-17...-16	2.0NM	T00-09P	T09P-2	T00-09P20
-22/27...-16	2.0NM	T00-09P	T09P-2	T00-09P20

General ISO Turning Holders
Steadyline®
MDT
Mini-Shaft™
Grooving
Parting-off
X4
Adapters Clamping units
Accessories and Spare parts
Workpiece materials

C.-PVUNR/L and C.-MVUNR/L – Toolholders for inserts VNGA, VNGG, VNGM, VNMA, VNMG and VNMU – Metric/ Inch

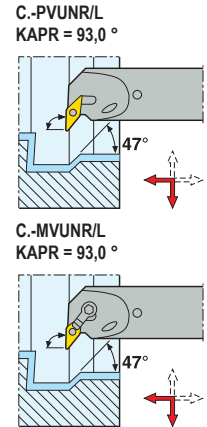
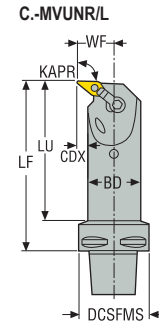
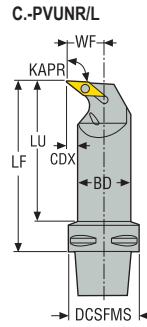
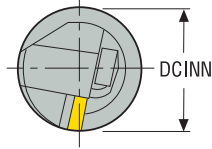

CTWS



- For inserts program, see page(s) 565, 566, 595
- GAMO° = Rake angle, LAMS° = Inclination angle
- CTMS = Seco-Capto™ size
- CTWS = Insert shape and size
- For holder code key, see page(s) 13-14
- Right-hand version shown
- Please check availability at www.secotools.com / Seco Online Store

Designation	Item number	CTMS	BD	DCSFMS	WF	LF	LU	CDX	DCINN	KAPR°	GAMO°	LAMS°	Weight	CTWS
			mm Inch	mm Inch	mm Inch	mm Inch	mm Inch	mm Inch	mm Inch					
C4-PVUNR-17090-13	00071983	C4	25,0 0.984	40,0 1.575	17,0 0.669	90,0 3.543	68,0 2.677	4,0 0.157	32,0 1.260	93,0	-5,0	-14,0	0,5 1.100	VN..1304.. VN..21.53.
C4-PVUNL-17090-13	00071980	C4	25,0 0.984	40,0 1.575	17,0 0.669	90,0 3.543	68,0 2.677	4,0 0.157	32,0 1.260	93,0	-5,0	-14,0	0,5 1.100	VN..1304.. VN..21.53.
C4-MVUNR-22110-16	00072631	C4	32,0 1.260	40,0 1.575	22,0 0.866	110,0 4.331	90,0 3.543	5,0 0.197	40,0 1.575	93,0	-5,0	-12,0	0,7 1.540	VN..1604.. VN..33.
C4-MVUNL-27120-16	00071985	C4	40,0 1.575	40,0 1.575	27,0 1.063	120,0 4.724	100,0 3.937	6,0 0.236	50,0 1.969	93,0	-5,0	-10,0	1,1 2.430	VN..1604.. VN..33.
C4-MVUNL-22110-16	00072638	C4	32,0 1.260	40,0 1.575	22,0 0.866	110,0 4.331	90,0 3.543	5,0 0.197	40,0 1.575	93,0	-5,0	-12,0	0,7 1.540	VN..1604.. VN..33.
C4-MVUNL-27120-16	00071981	C4	40,0 1.575	40,0 1.575	27,0 1.063	120,0 4.724	100,0 3.937	6,0 0.236	50,0 1.969	93,0	-5,0	-10,0	1,1 2.430	VN..1604.. VN..33.
C5-MVUNR-22110-16	00071991	C5	32,0 1.260	50,0 1.969	22,0 0.866	110,0 4.331	89,0 3.504	5,0 0.197	40,0 1.575	93,0	-5,0	-12,0	0,9 1.980	VN..1604.. VN..33.
C5-MVUNR-27140-16	00072664	C5	40,0 1.575	50,0 1.969	27,0 1.063	140,0 5.512	119,0 4.685	6,0 0.236	50,0 1.969	93,0	-5,0	-10,0	1,4 3.090	VN..1604.. VN..33.
C5-MVUNL-22110-16	00071989	C5	32,0 1.260	50,0 1.969	22,0 0.866	110,0 4.331	89,0 3.504	5,0 0.197	40,0 1.575	93,0	-5,0	-12,0	0,9 1.980	VN..1604.. VN..33.
C5-MVUNL-27140-16	00072679	C5	40,0 1.575	50,0 1.969	27,0 1.063	140,0 5.512	119,0 4.685	6,0 0.236	50,0 1.969	93,0	-5,0	-10,0	1,4 3.090	VN..1604.. VN..33.
C6-MVUNR-22120-16	00072035	C6	32,0 1.260	63,0 2.480	22,0 0.866	120,0 4.724	88,0 3.465	5,0 0.197	40,0 1.575	93,0	-5,0	-12,0	1,3 2.870	VN..1604.. VN..33.
C6-MVUNR-27145-16	00072036	C6	40,0 1.575	63,0 2.480	27,0 1.063	145,0 5.709	120,0 4.724	6,0 0.236	50,0 1.969	93,0	-5,0	-10,0	1,8 3.970	VN..1604.. VN..33.
C6-MVUNL-22120-16	00072033	C6	32,0 1.260	63,0 2.480	22,0 0.866	120,0 4.724	89,0 3.504	5,0 0.197	40,0 1.575	93,0	-5,0	-12,0	1,3 2.870	VN..1604.. VN..33.
C6-MVUNL-27145-16	00072034	C6	40,0 1.575	63,0 2.480	27,0 1.063	145,0 5.709	120,0 4.724	6,0 0.236	50,0 1.969	93,0	-5,0	-10,0	1,8 3.970	VN..1604.. VN..33.

Spare Parts

For size	Cantilever clamp	Clamp screw	Coolant nozzle	Insert key	Insert pin	Insert shim	Shim/clamp key	Shim pin
-13	-	-	CN6	T09P-2	PL1403-T09P	PVN130308	-	-
-16	MC20	LD6021-T09P	CN6	-	-	VSN160316	T09P-2	MN0909L-T09P

Accessories

For size	Insert clamping torque	Replacement blade	Torque key
-13	-	-	-
-16	2.0NM	T00-09P	T00-09P20

General ISO Turning
Holders

Steadyline®

MDT

Mini-Shaft™

Grooving

Parting-off

X4

Adapters
Clamping units

Accessories and
Spare parts

Workpiece
materials

C.-PWLNR/L – Toolholders for inserts WNGA, WNGG, WNMA, WNMG and WNMM – Metric/ Inch

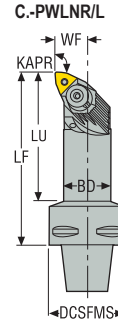
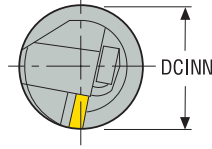

C.-PWLNR/L
KAPR = 95,0 °

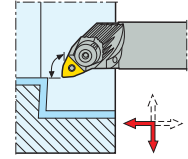

CTWS









- For inserts program, see page(s) 568, 569, 570, 571, 596
- GAMO° = Rake angle, LAMS° = Inclination angle
- CTMS = Seco-Capto™ size
- CTWS = Insert shape and size
- For holder code key, see page(s) 13-14
- Right-hand version shown
- * Use the right shim & the right screw for the selected insert. For details, see page 99
- Please check availability at www.secotools.com / Seco Online Store



Designation	Item number	CTMS	BD	DCSFMS	WF	LF	LU	DCINN	KAPR°	GAMO°	LAMS°	Weight	CTWS
			mm Inch	mm Inch	mm Inch	mm Inch	mm Inch	mm Inch				kg lbs	
C4-PWLN-13080-06	00012937	C4	20,0 0.787	40,0 1.575	13,0 0.512	80,0 3.150	57,0 2.244	25,0 0.984	95,0	-5,0	-11,0	0,4 0.880	WN..0604.. WN..33.
C4-PWLN-17090-06	00092073	C4	25,0 0.984	40,0 1.575	17,0 0.669	90,0 3.543	68,0 2.677	32,0 1.260	95,0	-5,0	-12,0	0,5 1.100	WN..0604.. WN..33.
C4-PWLN-22110-06	00092075	C4	32,0 1.260	40,0 1.575	22,0 0.866	110,0 4.331	89,0 3.504	40,0 1.575	95,0	-5,0	-12,0	0,7 1.540	WN..0604.. WN..33.
C4-PWLN-13080-06	00012922	C4	20,0 0.787	40,0 1.575	13,0 0.512	80,0 3.150	57,0 2.244	25,0 0.984	95,0	-5,0	-11,0	0,4 0.880	WN..0604.. WN..33.
C4-PWLN-17090-06	00092072	C4	25,0 0.984	40,0 1.575	17,0 0.669	90,0 3.543	68,0 2.677	32,0 1.260	95,0	-5,0	-12,0	0,5 1.100	WN..0604.. WN..33.
C4-PWLN-22110-08	00092077	C4	32,0 1.260	40,0 1.575	22,0 0.866	110,0 4.331	89,0 3.504	40,0 1.575	95,0	-5,0	-11,0	0,7 1.540	WN..0804/WN..0806 WN..43/WN..44*
C4-PWLN-27120-08	00071982	C4	40,0 1.575	40,0 1.575	27,0 1.063	120,0 4.724	100,0 3.937	50,0 1.969	95,0	-5,0	-8,0	1,0 2.200	WN..0804/WN..0806 WN..43/WN..44*
C4-PWLN-22110-08	00092076	C4	32,0 1.260	40,0 1.575	22,0 0.866	110,0 4.331	89,0 3.504	40,0 1.575	95,0	-5,0	-11,0	0,7 1.540	WN..0804/WN..0806 WN..43/WN..44*
C4-PWLN-27120-08	00071979	C4	40,0 1.575	40,0 1.575	27,0 1.063	120,0 4.724	100,0 3.937	50,0 1.969	95,0	-5,0	-8,0	1,0 2.200	WN..0804/WN..0806 WN..43/WN..44*
C5-PWLN-13080-06	00072015	C5	20,0 0.787	50,0 1.969	13,0 0.512	80,0 3.150	56,0 2.205	25,0 0.984	95,0	-5,0	-11,0	0,6 1.320	WN..0604.. WN..33.
C5-PWLN-17090-06	00092079	C5	25,0 0.984	50,0 1.969	17,0 0.669	90,0 3.543	67,0 2.638	32,0 1.260	95,0	-5,0	-12,0	0,7 1.540	WN..0604.. WN..33.
C5-PWLN-22110-06	75094583	C5	32,0 1.260	50,0 1.969	22,0 0.866	110,0 4.331	88,0 3.465	40,0 1.575	95,0	-5,0	-12,0	0,9 1.980	WN..0604.. WN..33.
C5-PWLN-13080-06	00071986	C5	20,0 0.787	50,0 1.969	13,0 0.512	80,0 3.150	56,0 2.205	25,0 0.984	95,0	-5,0	-11,0	0,6 1.320	WN..0604.. WN..33.
C5-PWLN-17090-06	00092078	C5	25,0 0.984	50,0 1.969	17,0 0.669	90,0 3.543	67,0 2.638	32,0 1.260	95,0	-5,0	-12,0	0,7 1.540	WN..0604.. WN..33.
C5-PWLN-22110-06	75094584	C5	32,0 1.260	50,0 1.969	22,0 0.866	110,0 4.331	88,0 3.465	40,0 1.575	95,0	-5,0	-12,0	0,9 1.980	WN..0604.. WN..33.
C5-PWLN-22110-08	00092081	C5	32,0 1.260	50,0 1.969	22,0 0.866	110,0 4.331	88,0 3.465	40,0 1.575	95,0	-5,0	-11,0	0,9 1.980	WN..0804/WN..0806 WN..43/WN..44*
C5-PWLN-27140-08	00094494	C5	40,0 1.575	50,0 1.969	27,0 1.063	140,0 5.512	119,0 4.685	50,0 1.969	95,0	-5,0	-11,0	1,4 3.090	WN..0804/WN..0806 WN..43/WN..44*
C5-PWLN-22110-08	00092080	C5	32,0 1.260	50,0 1.969	22,0 0.866	110,0 4.331	88,0 3.465	40,0 1.575	95,0	-5,0	-11,0	0,9 1.980	WN..0804/WN..0806 WN..43/WN..44*
C5-PWLN-27140-08	00094495	C5	40,0 1.575	50,0 1.969	27,0 1.063	140,0 5.512	119,0 4.685	50,0 1.969	95,0	-5,0	-11,0	1,4 3.090	WN..0804/WN..0806 WN..43/WN..44*
C6-PWLN-27140-08	00072040	C6	40,0 1.575	63,0 2.480	27,0 1.063	140,0 5.512	115,0 4.528	50,0 1.969	95,0	-5,0	-8,0	1,7 3.750	WN..0804/WN..0806 WN..43/WN..44*
C6-PWLN-35175-08	00072047	C6	50,0 1.969	63,0 2.480	35,0 1.378	175,0 6.890	152,0 5.984	63,0 2.480	95,0	-5,0	-10,0	2,6 5.730	WN..0804/WN..0806 WN..43/WN..44*

Designation	Item number	CTMS	BD	DCSFMS	WF	LF	LU	DCINN	KAPR°	GAMO°	LAMS°	Weight	CTWS
			mm Inch	mm Inch	mm Inch	mm Inch	mm Inch	mm Inch				kg lbs	
C6-PWLN-27140-08	00045763	C6	40,0 1.575	63,0 2.480	27,0 1.063	140,0 5.512	115,0 4.528	50,0 1.969	95,0	-5,0	-8,0	1,7 3.750	WN..0804/WN..0806 WN..43/WN..44*
C6-PWLN-35175-08	00072038	C6	50,0 1.969	63,0 2.480	35,0 1.378	175,0 6.890	152,0 5.984	63,0 2.480	95,0	-5,0	10,0	2,6 5.730	WN..0804/WN..0806 WN..43/WN..44*

Spare Parts

For size	Insert shim	Setting screw	Shim pin	Wedge clamp	Wedge key	Wedge screw
						
-13/17...-06	WAI060212	L82511-T07P	PP1209-T09P	WNW06HD	T20P-7	WS1920-T20P
-22...-06	WAE060312	L82511-T07P	PP1409-T09P	WNW06HD	T20P-7	WS1920-T20P
-08	WAI080312	L82511-T07P	PP1415-T15P	WNW08HD	T25P-7	WS2325-T25P
-1...-06	WAI060212	L82511-T07P	PP1209-T09P	WNW06HD	T20P-7	WS1920-T20P
-2...-06	WAE060312	L82511-T07P	PP1409-T09P	WNW06HD	T20P-7	WS1920-T20P

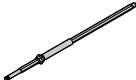
Accessories

For size	Insert clamping torque	Replacement blade	Shim key	Torque key
				
-13/17...-06	3.5NM	T00-20P	T09P-2	T00-20P35
-22...-06	3.5NM	T00-20P	T09P-2	T00-20P35
-08	5.0NM	T00T-25P	T15P-2	T00T-25P50
-1...-06	3.5NM	T00-20P	T09P-2	T00-20P35
-2...-06	3.5NM	T00-20P	T09P-2	T00-20P35

General ISO Turning Holders
Steadyline®
MDT
Mini-Shaft™
Grooving
Parting-off
X4
Adapters Clamping units
Accessories and Spare parts
Workpiece materials

C-SCLCR/L – Toolholders for inserts CCGT, CCGW, CCGX, CCMT and CCMW – Metric/ Inch

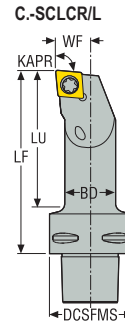
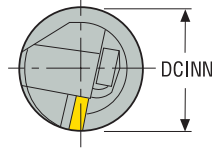

C-SCLCR/L
KAPRI = 95,0 °

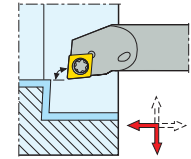





CTWS





- For inserts program, see page(s) 522, 523, 524, 525, 573, 574, 597, 599
- GAMO° = Rake angle, LAMS° = Inclination angle CTMS = Seco-Capto™ size
- CTWS = Insert shape and size
- For holder code key, see page(s) 13-14
- Right-hand version shown
- Please check availability at www.secotools.com / Seco Online Store

Designation	Item number	CTMS	BD	DCSFMS	WF	LF	LU	DCINN	KAPRI°	GAMO°	LAMS°	Weight	CTWS
			mm Inch	mm Inch	mm Inch	mm Inch	mm Inch	mm Inch				kg lbs	
C3-SCLCR-11065-09	00094071	C3	16,0 0.630	32,0 1.260	11,0 0.433	65,0 2.559	48,0 1.890	20,0 0.787	95,0	0,0	-12,0	0,2 0.440	CC..09T3.. CC..32.5
C3-SCLCL-11065-09	00094061	C3	16,0 0.630	32,0 1.260	11,0 0.433	65,0 2.559	48,0 1.890	20,0 0.787	95,0	0,0	-12,0	0,2 0.440	CC..09T3.. CC..32.5
C4-SCLCR-11070-09	00084494	C4	16,0 0.630	40,0 1.575	11,0 0.433	70,0 2.756	47,0 1.850	20,0 0.787	95,0	0,0	-12,0	0,4 0.880	CC..09T3.. CC..32.5
C4-SCLCR-13080-09	00084495	C4	20,0 0.787	40,0 1.575	13,0 0.512	80,0 3.150	57,0 2.244	25,0 0.984	95,0	0,0	-8,0	0,4 0.880	CC..09T3.. CC..32.5
C4-SCLCR-17090-09	75069012	C4	25,0 0.984	40,0 1.575	17,0 0.669	90,0 3.543	68,0 2.677	32,0 1.260	95,0	0,0	-6,0	0,5 1.100	CC..09T3.. CC..32.5
C4-SCLCL-11070-09	75065645	C4	16,0 0.630	40,0 1.575	11,0 0.433	70,0 2.756	47,0 1.850	20,0 0.787	95,0	0,0	-12,0	0,4 0.880	CC..09T3.. CC..32.5
C4-SCLCL-13080-09	00084496	C4	20,0 0.787	40,0 1.575	13,0 0.512	80,0 3.150	57,0 2.244	25,0 0.984	95,0	0,0	-8,0	0,4 0.880	CC..09T3.. CC..32.5
C4-SCLCL-17090-09	00094160	C4	25,0 0.984	40,0 1.575	17,0 0.669	90,0 3.543	68,0 2.677	32,0 1.260	95,0	0,0	-6,0	0,5 1.100	CC..09T3.. CC..32.5
C4-SCLCR-22110-12	00094167	C4	32,0 1.260	40,0 1.575	22,0 0.866	110,0 4.331	89,0 3.504	40,0 1.575	95,0	0,0	-10,0	0,8 1.760	CC..1204.. CC..43
C5-SCLCR-11070-09	00094268	C5	16,0 0.630	50,0 1.969	11,0 0.433	70,0 2.756	46,0 1.811	20,0 0.787	95,0	0,0	-12,0	0,5 1.100	CC..09T3.. CC..32.5
C5-SCLCR-13080-09	00094270	C5	20,0 0.787	50,0 1.969	13,0 0.512	80,0 3.150	56,0 2.205	25,0 0.984	95,0	0,0	-8,0	0,6 1.320	CC..09T3.. CC..32.5
C5-SCLCR-17090-09	00094271	C5	25,0 0.984	50,0 1.969	17,0 0.669	90,0 3.543	67,0 2.638	32,0 1.260	95,0	0,0	-6,0	0,7 1.540	CC..09T3.. CC..32.5
C5-SCLCL-11070-09	00094249	C5	16,0 0.630	50,0 1.969	11,0 0.433	70,0 2.756	46,0 1.811	20,0 0.787	95,0	0,0	-12,0	0,5 1.100	CC..09T3.. CC..32.5
C5-SCLCL-13080-09	00094253	C5	20,0 0.787	50,0 1.969	13,0 0.512	80,0 3.150	56,0 2.205	25,0 0.984	95,0	0,0	-8,0	0,6 1.320	CC..09T3.. CC..32.5
C5-SCLCL-17090-09	00094255	C5	25,0 0.984	50,0 1.969	17,0 0.669	90,0 3.543	67,0 2.638	32,0 1.260	95,0	0,0	-6,0	0,7 1.540	CC..09T3.. CC..32.5
C5-SCLCR-27140-12	00094275	C5	40,0 1.575	50,0 1.969	27,0 1.063	140,0 5.512	119,0 4.685	50,0 1.969	95,0	0,0	-8,0	1,5 3.310	CC..1204.. CC..43
C5-SCLCL-27140-12	00094259	C5	40,0 1.575	50,0 1.969	27,0 1.063	140,0 5.512	119,0 4.685	50,0 1.969	95,0	0,0	-8,0	1,5 3.310	CC..1204.. CC..43

Spare Parts

For size	Insert key	Insert screw	Insert shim	Shim screw
				
11065-09	T15P-2	C03508-T15P	-	-
11070-09	T15P-2	C03508-T15P	-	-
13080-09	T15P-2	C03508-T15P	-	-
17090-09	T15P-2	C03510-T15P	-	-
22110-12	T15P-2	C04014-T15P	SCN12T308	CA4010
27140-12	T15P-2	C04014-T15P	SCN12T308	CA4010

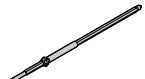
Accessories

For size	Insert clamping torque	Replacement blade	Shim key	Torque key
				
11065-09	3.0NM	T00-15P	-	T00-15P30
11070-09	3.0NM	T00-15P	-	T00-15P30
13080-09	3.0NM	T00-15P	-	T00-15P30
17090-09	3.0NM	T00-15P	-	T00-15P30
22110-12	3.5NM	T00-15P	4SMS795	T00-15P35
27140-12	3.5NM	T00-15P	4SMS795	T00-15P35

General ISO Turning
Holders

Steadyline®

MDT

Mini-Shaft™

Grooving

Parting-off

X4

Adapters
Clamping units

Accessories and
Spare parts

Workpiece
materials

C.-SDQNR/L and C.-PDQNR/L – Toolholders for inserts DNMA and DNMU – Metric/ Inch

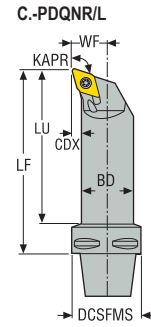
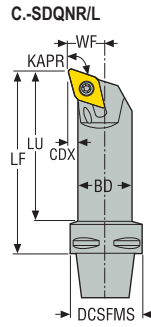
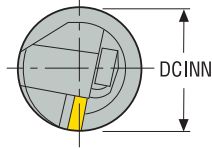

C4-SD../PD..
KAPR = 107,5°

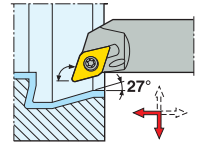

C5-SD../PD..
KAPR = 107,5°

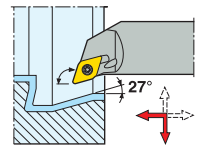

CTWS





- For inserts program, see page(s) 537, 538, 539, 540, 541, 580
- GAMO° = Rake angle, LAMS° = Inclination angle
- CTMS = Seco-Capto™ size
- CTWS = Insert shape and size
- For holder code key, see page(s) 13-14
- Right-hand version shown
- Please check availability at www.secotools.com / Seco Online Store

Designation	Item number	CTMS	BD	DCSFMS	WF	LF	LU	CDX	DCINN	KAPR°	GAMO°	LAMS°	Weight	CTWS
			mm Inch	mm Inch	mm Inch	mm Inch	mm Inch	mm Inch	mm Inch					
C4-SDQNR-11065-11	00072404	C4	16,0 0.630	40,0 1.575	11,0 0.433	65,0 2.559	41,0 1.614	2,5 0.098	20,0 0.787	107,5	-5,0	-17,0	0,4 0.880	DN..1104.. DN..33.
C4-SDQNR-13080-11	00072447	C4	20,0 0.787	40,0 1.575	13,0 0.512	80,0 3.150	56,0 2.205	2,5 0.098	25,0 0.984	107,5	-5,0	-17,0	0,4 0.880	DN..1104.. DN..33.
C4-SDQNL-11065-11	00072441	C4	16,0 0.630	40,0 1.575	11,0 0.433	65,0 2.559	41,0 1.614	2,5 0.098	20,0 0.787	107,5	-5,0	-17,0	0,4 0.880	DN..1104.. DN..33.
C4-SDQNL-13080-11	00072454	C4	20,0 0.787	40,0 1.575	13,0 0.512	80,0 3.150	56,0 2.205	2,5 0.098	25,0 0.984	107,5	-5,0	-17,0	0,4 0.880	DN..1104.. DN..33.
C4-PDQNR-22110-11	00072510	C4	32,0 1.260	40,0 1.575	22,0 0.866	110,0 4.331	89,0 3.504	5,0 0.197	40,0 1.575	107,5	-5,0	-14,0	0,7 1.540	DN..1104.. DN..33.
C4-PDQNL-22110-11	00072512	C4	32,0 1.260	40,0 1.575	22,0 0.866	110,0 4.331	89,0 3.504	5,0 0.197	40,0 1.575	107,5	-5,0	-14,0	0,7 1.540	DN..1104.. DN..33.
C5-SDQNR-13080-11	00072455	C5	20,0 0.787	50,0 1.969	13,0 0.512	80,0 3.150	56,0 2.205	2,5 0.098	25,0 0.984	107,5	-5,0	-18,0	0,6 1.320	DN..1104.. DN..33.
C5-SDQNL-13080-11	00072462	C5	20,0 0.787	50,0 1.969	13,0 0.512	80,0 3.150	56,0 2.205	2,5 0.098	25,0 0.984	107,5	-5,0	-18,0	0,6 1.320	DN..1104.. DN..33.
C5-PDQNR-22110-11	00072546	C5	32,0 1.260	50,0 1.969	22,0 0.866	110,0 4.331	89,0 3.504	5,0 0.197	40,0 1.575	107,5	-5,0	-14,0	0,9 1.980	DN..1104.. DN..33.
C5-PDQNL-22110-11	00072557	C5	32,0 1.260	50,0 1.969	22,0 0.866	110,0 4.331	89,0 3.504	5,0 0.197	40,0 1.575	107,5	-5,0	-14,0	0,9 1.980	DN..1104.. DN..33.

Spare Parts

For size	Insert key	Insert pin	Insert screw	Insert shim	Shim screw
-11..	T09P-2	-	C03511-T09P	-	-
-13..	T09P-2	-	C03511-T09P	DAI110212	CA3507
-22..	T09P-2	PL1403-T09P	-	DAE110312	-

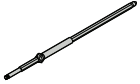
Accessories

For size	Insert clamping torque	Replacement blade	Shim key	Torque key
-11..	2.0NM 	 T00-09P	 -	T00-09P20 
-13..	2.0NM	T00-09P	9/64SMS875	T00-09P20
-22..	-	-	-	-

General ISO Turning
Holders

Steadyline®

MDT

Mini-Shaft™

Grooving

Parting-off

X4

Adapters
Clamping units

Accessories and
Spare parts

Workpiece
materials

C.-SDUCR/L – Toolholders for inserts DCGT, DCGW, DCMT, DCMW and DCMX – Metric/ Inch

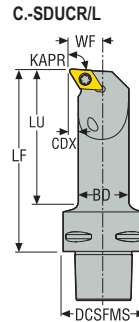
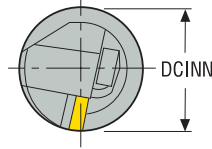

C.-SDUCR/L
KAPR = 93,0 °

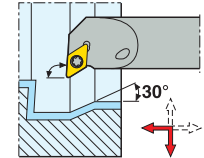





CTWS





- For inserts program, see page(s) 534, 535, 536, 578, 600
- GAMO° = Rake angle, LAMS° = Inclination angle
- CTMS = Seco-Capto™ size
- CTWS = Insert shape and size
- For holder code key, see page(s) 13-14
- Right-hand version shown
- Please check availability at www.secotools.com / Seco Online Store

Designation	Item number	CTMS	BD	DCSFMS	WF	LF	LU	CDX	DCINN	KAPR°	GAMO°	LAMS°	Weight	CTWS
			mm Inch	mm Inch	mm Inch	mm Inch	mm Inch	mm Inch	mm Inch					
C4-SDUCR-11070-07	00094180	C4	16,0 0.630	40,0 1.575	11,0 0.433	70,0 2.756	47,0 1.850	2,5 0.098	20,0 0.787	93,0	0,0	-8,0	0,4 0.880	DC..0702.. DC..21.5.
C4-SDUCL-11070-07	00094173	C4	16,0 0.630	40,0 1.575	11,0 0.433	70,0 2.756	47,0 1.850	2,5 0.098	20,0 0.787	93,0	0,0	-8,0	0,4 0.880	DC..0702.. DC..21.5.
C4-SDUCR-13080-11	75065648	C4	20,0 0.787	40,0 1.575	13,0 0.512	80,0 3.150	57,0 2.244	2,5 0.098	25,0 0.984	93,0	0,0	-8,0	0,4 0.880	DC..11T3.. DC..32.5.
C4-SDUCR-17090-11	00094182	C4	25,0 0.984	40,0 1.575	17,0 0.669	90,0 3.543	68,0 2.677	4,0 0.157	32,0 1.260	93,0	0,0	-6,0	0,5 1.100	DC..11T3.. DC..32.5.
C4-SDUCR-22110-11	00094184	C4	32,0 1.260	40,0 1.575	22,0 0.866	110,0 4.331	89,0 3.504	5,0 0.197	40,0 1.575	93,0	0,0	-6,0	0,8 1.760	DC..11T3.. DC..32.5.
C4-SDUCR-27080-11	00094185	C4	40,0 1.575	40,0 1.575	27,0 1.063	80,0 3.150	60,0 2.362	6,0 0.236	50,0 1.969	93,0	0,0	-6,0	0,7 1.540	DC..11T3.. DC..32.5.
C4-SDUCL-13080-11	75068289	C4	20,0 0.787	40,0 1.575	13,0 0.512	80,0 3.150	57,0 2.244	2,5 0.098	25,0 0.984	93,0	0,0	-8,0	0,4 0.880	DC..11T3.. DC..32.5.
C4-SDUCL-17090-11	00094176	C4	25,0 0.984	40,0 1.575	17,0 0.669	90,0 3.543	68,0 2.677	4,0 0.157	32,0 1.260	93,0	0,0	-6,0	0,5 1.100	DC..11T3.. DC..32.5.
C4-SDUCL-22110-11	00094178	C4	32,0 1.260	40,0 1.575	22,0 0.866	110,0 4.331	89,0 3.504	5,0 0.197	40,0 1.575	93,0	0,0	-6,0	0,8 1.760	DC..11T3.. DC..32.5.
C4-SDUCL-27080-11	00094179	C4	40,0 1.575	40,0 1.575	27,0 1.063	80,0 3.150	60,0 2.362	6,0 0.236	50,0 1.969	93,0	0,0	-6,0	0,7 1.540	DC..11T3.. DC..32.5.
C5-SDUCR-11070-07	00094291	C5	16,0 0.630	50,0 1.969	11,0 0.433	70,0 2.756	46,0 1.811	2,5 0.098	20,0 0.787	93,0	0,0	-8,0	0,5 1.100	DC..0702.. DC..21.5.
C5-SDUCL-11070-07	00094284	C5	16,0 0.630	50,0 1.969	11,0 0.433	70,0 2.756	46,0 1.811	2,5 0.098	20,0 0.787	93,0	0,0	-8,0	0,5 1.100	DC..0702.. DC..21.5.
C5-SDUCR-13080-11	00094293	C5	20,0 0.787	50,0 1.969	13,0 0.512	80,0 3.150	56,0 2.205	2,5 0.098	25,0 0.984	93,0	0,0	-8,0	0,6 1.320	DC..11T3.. DC..32.5.
C5-SDUCR-17090-11	00094295	C5	25,0 0.984	50,0 1.969	17,0 0.669	90,0 3.543	67,0 2.638	4,0 0.157	32,0 1.260	93,0	0,0	-6,0	0,7 1.540	DC..11T3.. DC..32.5.
C5-SDUCR-22110-11	00094297	C5	32,0 1.260	50,0 1.969	22,0 0.866	110,0 4.331	88,0 3.465	5,0 0.197	40,0 1.575	93,0	0,0	-6,0	0,9 1.980	DC..11T3.. DC..32.5.
C5-SDUCR-35100-11	00094298	C5	50,0 1.969	50,0 1.969	35,0 1.378	100,0 3.937	80,0 3.150	6,0 0.236	63,0 2.480	93,0	0,0	-4,0	1,4 3.090	DC..11T3.. DC..32.5.
C5-SDUCL-13080-11	00094285	C5	20,0 0.787	50,0 1.969	13,0 0.512	80,0 3.150	56,0 2.205	2,5 0.098	25,0 0.984	93,0	0,0	-8,0	0,6 1.320	DC..11T3.. DC..32.5.
C5-SDUCL-17090-11	00094287	C5	25,0 0.984	50,0 1.969	17,0 0.669	90,0 3.543	67,0 2.638	4,0 0.157	32,0 1.260	93,0	0,0	-6,0	0,7 1.540	DC..11T3.. DC..32.5.
C5-SDUCL-22110-11	00094289	C5	32,0 1.260	50,0 1.969	22,0 0.866	110,0 4.331	88,0 3.465	5,0 0.197	40,0 1.575	93,0	0,0	-6,0	0,9 1.980	DC..11T3.. DC..32.5.
C5-SDUCL-35100-11	00094290	C5	50,0 1.969	50,0 1.969	35,0 1.378	100,0 3.937	80,0 3.150	6,0 0.236	63,0 2.480	93,0	0,0	-4,0	1,4 3.090	DC..11T3.. DC..32.5.

Spare Parts

For size	Insert key 	Insert screw 	Insert shim 	Shim screw 
-07	T07P-2	C02506-T07P	-	-
-13...-11	T15P-2	C03508-T15P	-	-
-17...-11	T15P-2	C03510-T15P	-	-
-2...-11	T15P-2	C03512-T15P	126.19-620	CA3507
-22/35...-11	T15P-2	C03512-T15P	126.19-620	CA3507

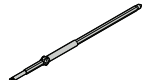
Accessories

For size	Insert clamping torque 	Replacement blade 	Shim key 	Torque key 
-07	0.9NM	T00-07P	-	T00-07P09
-13...-11	3.0NM	T00-15P	-	T00-15P30
-17...-11	3.0NM	T00-15P	-	T00-15P30
-2...-11	3.0NM	T00-15P	9/64SMS875	T00-15P30
-22/35...-11	3.0NM	T00-15P	9/64SMS875	T00-15P30

General ISO Turning
Holders

Steadyline®

MDT

Mini-Shaft™

Grooving

Parting-off

X4

Adapters
Clamping units

Accessories and
Spare parts

Workpiece
materials

C.-SDUCR/L-..X – Toolholders for inserts DCGT, DCGW, DCMT and DCMW – Metric/ Inch

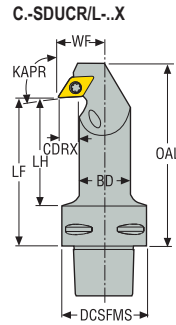
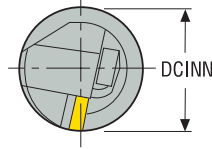

C.-SDUCR/L-..X
KAPR = 93,0 °

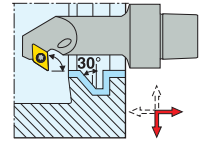



CTWS





- For inserts program, see page(s) 534, 535, 536, 578, 600
- GAMO° = Rake angle, LAMS° = Inclination angle
- CTMS = Seco-Capto™ size
- CTWS = Insert shape and size
- For holder code key, see page(s) 13-14
- Right-hand version shown
- Please check availability at www.secotools.com / Seco Online Store

Designation	Item number	CTMS	BD	DCSFMS	WF	LF	CDX	OAL	DCINN	KAPR°	GAMO°	LAMS°	Weight	CTWS
			mm Inch	mm Inch	mm Inch	mm Inch	mm Inch	mm Inch	mm Inch					
C4-SDUCR-13070-07X	00089627	C4	16,0 0.630	40,0 1.575	13,0 0.512	70,0 2.756	4,0 0.157	81,0 3.189	22,0 0.866	93,0	0,0	-6,0	0,4 0.880	DC..0702.. DC..21.5.
C4-SDUCL-13070-07X	00094174	C4	16,0 0.630	40,0 1.575	13,0 0.512	70,0 2.756	4,0 0.157	81,0 3.189	22,0 0.866	93,0	0,0	-6,0	0,4 0.880	DC..0702.. DC..21.5.

Spare Parts

For size	Insert key	Insert screw
-07X	 T07P-2	 C02506-T07P

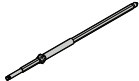
Accessories

For size	Insert clamping torque	Replacement blade	Torque key
-07X	 0.9NM	 T00-07P	 T00-07P09

General ISO Turning Holders
Steadyline®
MDT
Mini-Shaft™
Grooving
Parting-off
X4
Adapters Clamping units
Accessories and Spare parts
Workpiece materials

C.-SDUNR/L and C.-PDUNR/L – Toolholders for inserts DNMA, DNMU and DNMX – Metric / Inch

C4-SD../PD..
KAPR = 93,0°

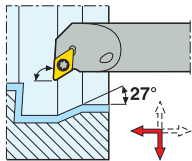

C5-SD../PD..
KAPR = 93,0°

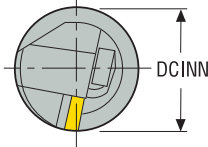
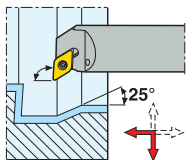

C.-SDUNR/L

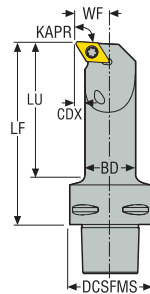

C.-PDUNR/L

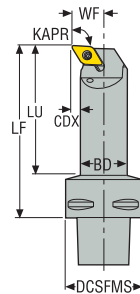

CTWS



- For inserts program, see page(s) 537, 538, 539, 540, 541, 580
- GAMO° = Rake angle, LAMS° = Inclination angle
- CTMS = Seco-Capto™ size
- CTWS = Insert shape and size
- For holder code key, see page(s) 13-14
- Right-hand version shown
- Please check availability at www.secotools.com / Seco Online Store



Designation	Item number	CTMS	BD	DCSFMS	WF	LF	LU	CDX	DCINN	KAPR°	GAMO°	LAMS°	Weight	CTWS
			mm Inch	mm Inch	mm Inch	mm Inch	mm Inch	mm Inch	mm Inch					
C4-SDUNR-11065-11	00072369	C4	16,0 0.630	40,0 1.575	11,0 0.433	65,0 2.559	41,0 1.614	2,5 0.098	20,0 0.787	93,0	-5,0	-17,0	0,3 0.660	DN..1104.. DN..33.
C4-SDUNR-13080-11	00092041	C4	20,0 0.787	40,0 1.575	13,0 0.512	80,0 3.150	56,0 2.205	2,5 0.098	25,0 0.984	93,0	-5,0	-14,0	0,4 0.880	DN..1104.. DN..33.
C4-SDUNL-11065-11	00072396	C4	16,0 0.630	40,0 1.575	11,0 0.433	65,0 2.559	41,0 1.614	2,5 0.098	20,0 0.787	93,0	-5,0	-17,0	0,3 0.660	DN..1104.. DN..33.
C4-SDUNL-13080-11	00092040	C4	20,0 0.787	40,0 1.575	13,0 0.512	80,0 3.150	56,0 2.205	2,5 0.098	25,0 0.984	93,0	-5,0	-14,0	0,4 0.880	DN..1104.. DN..33.
C4-PDUNR-17090-11	00092043	C4	25,0 0.984	40,0 1.575	17,0 0.669	90,0 3.543	68,0 2.677	4,0 0.157	32,0 1.260	93,0	-5,0	-13,0	0,5 1.100	DN..1104.. DN..33.
C4-PDUNR-22110-11	00092045	C4	32,0 1.260	40,0 1.575	22,0 0.866	110,0 4.331	89,0 3.504	5,0 0.197	40,0 1.575	93,0	-5,0	-11,0	0,7 1.540	DN..1104.. DN..33.
C4-PDUNL-17090-11	00092042	C4	25,0 0.984	40,0 1.575	17,0 0.669	90,0 3.543	68,0 2.677	4,0 0.157	32,0 1.260	93,0	-5,0	-13,0	0,5 1.100	DN..1104.. DN..33.
C4-PDUNL-22110-11	00092044	C4	32,0 1.260	40,0 1.575	22,0 0.866	110,0 4.331	89,0 3.504	5,0 0.197	40,0 1.575	93,0	-5,0	-11,0	0,7 1.540	DN..1104.. DN..33.
C5-SDUNR-13080-11	00092047	C5	20,0 0.787	50,0 1.969	13,0 0.512	80,0 3.150	56,0 2.205	2,5 0.098	25,0 0.984	93,0	-5,0	-14,0	0,6 1.320	DN..1104.. DN..33.
C5-SDUNL-13080-11	00092046	C5	20,0 0.787	50,0 1.969	13,0 0.512	80,0 3.150	56,0 2.205	2,5 0.098	25,0 0.984	93,0	-5,0	-14,0	0,6 1.320	DN..1104.. DN..33.
C5-PDUNR-17090-11	00092049	C5	25,0 0.984	50,0 1.969	17,0 0.669	90,0 3.543	67,0 2.638	4,0 0.157	32,0 1.260	93,0	-5,0	-13,0	0,7 1.540	DN..1104.. DN..33.
C5-PDUNR-22110-11	00092051	C5	32,0 1.260	50,0 1.969	22,0 0.866	110,0 4.331	89,0 3.504	5,0 0.197	40,0 1.575	93,0	-5,0	-11,0	0,9 1.980	DN..1104.. DN..33.
C5-PDUNL-17090-11	00092048	C5	25,0 0.984	50,0 1.969	17,0 0.669	90,0 3.543	67,0 2.638	4,0 0.157	32,0 1.260	93,0	-5,0	-13,0	0,7 1.540	DN..1104.. DN..33.
C5-PDUNL-22110-11	00092050	C5	32,0 1.260	50,0 1.969	22,0 0.866	110,0 4.331	89,0 3.504	5,0 0.197	40,0 1.575	93,0	-5,0	-11,0	0,9 1.980	DN..1104.. DN..33.

Spare Parts

For size	Coolant nozzle	Insert key	Insert pin	Insert screw	Insert shim	Shim screw
-11...-11	-	T09P-2	-	C03511-T09P	-	-
-13...-11	-	T09P-2	-	C03511-T09P	DAI110212	CA3507
-17/22...-11	CN6	T09P-2	PL1403-T09P	-	DAE110312	-

General ISO Turning Holders
Steadyline®
MDT
Mini-Shaft™
Grooving
Parting-off
X4
Adapters Clamping units
Accessories and Spare parts
Workpiece materials

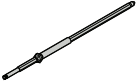
Accessories

For size	Insert clamping torque 	Replacement blade 	Shim key 	Torque key 
-11...-11	2.0NM	T00-09P	-	T00-09P20
-13...-11	2.0NM	T00-09P	9/64SMS875	T00-09P20
-17/22...-11	-	-	-	-

General ISO Turning
Holders

Steadyline®

MDT

Mini-Shaft™

Grooving

Parting-off

X4

Adapters
Clamping units

Accessories and
Spare parts

Workpiece
materials

C.-STFCR/L – Toolholders for inserts TCGT, TCMT and TCMW – Metric/ Inch

C.-STFCR/L
KAPR = 90,0°

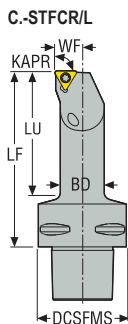
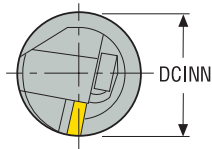
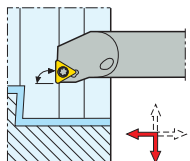



CTWS





- For inserts program, see page(s) 555, 556, 601
- GAMO° = Rake angle, LAMS° = Inclination angle
- CTMS = Seco-Capto™ size
- CTWS = Insert shape and size
- For holder code key, see page(s) 13-14
- Right-hand version shown
- Please check availability at www.secotools.com / Seco Online Store

Designation	Item number	CTMS	BD	DCSEMS	WF	LF	LU	DCINN	KAPR°	GAMO°	LAMS°	Weight	CTWS
			mm Inch	mm Inch	mm Inch	mm Inch	mm Inch	mm Inch				mm Inch	
C4-STFCR-11070-11	00084501	C4	16,0 0.630	40,0 1.575	11,0 0.433	70,0 2.756	47,0 1.850	20,0 0.787	90,0	0,0	-4,0	0,4 0.880	TC..1102.. TC..21.5.
C4-STFCL-11070-11	00084502	C4	16,0 0.630	40,0 1.575	11,0 0.433	70,0 2.756	47,0 1.850	20,0 0.787	90,0	0,0	-4,0	0,4 0.880	TC..1102.. TC..21.5.
C4-STFCL-13080-11	00084504	C4	20,0 0.787	40,0 1.575	13,0 0.512	80,0 3.150	57,0 2.244	25,0 0.984	90,0	0,0	-3,0	0,4 0.880	TC..1102.. TC..21.5.
C5-STFCR-11070-11	00094373	C5	16,0 0.630	50,0 1.969	11,0 0.433	70,0 2.756	46,0 1.811	40,0 1.575	90,0	0,0	-4,0	0,6 1.320	TC..1102.. TC..21.5.

Spare Parts

For size	Insert key	Insert screw
-11	 T07P-2	 C02506-T07P

Accessories

For size	Insert clamping torque	Replacement blade	Torque key
-11	 0.9NM	 T00-07P	 T00-07P09

General ISO Turning
Holders

Steadyline®

MDT

Mini-Shaft™

Grooving

Parting-off

X4

Adapters
Clamping units

Accessories and
Spare parts

Workpiece
materials

C.-SVQBR/L – Toolholders for inserts VBGW, VBMT, VBMTW and VCGT – Metric/ Inch

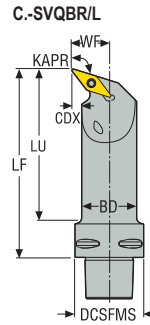
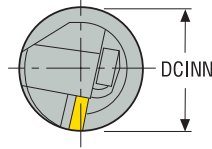

C.-SVQBR/L
KAPR = 107,5°

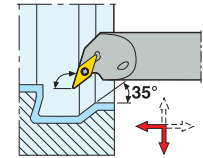





CTWS





- For inserts program, see page(s) 563, 564, 564, 594, 602
- GAMO° = Rake angle, LAMS° = Inclination angle
- CTMS = Seco-Capto™ size
- CTWS = Insert shape and size
- For holder code key, see page(s) 13-14
- Right-hand version shown
- Please check availability at www.secotools.com / Seco Online Store

Designation	Item number	CTMS	BD	DCSFMS	WF	LF	LU	CDX	DCINN	KAPR°	GAMO°	LAMS°	Weight	CTWS
			mm Inch	mm Inch	mm Inch	mm Inch	mm Inch	mm Inch	mm Inch					
C3-SVQBR-13070-11	00094153	C3	16,0 0.630	32,0 1.260	13,0 0.512	70,0 2.756	53,0 2.087	4,0 0.157	22,0 0.866	107,5	0,0	-7,0	0,2 0.440	VB..1102.. VB..21.5.
C3-SVQBL-13070-11	00094147	C3	16,0 0.630	32,0 1.260	13,0 0.512	70,0 2.756	53,0 2.087	4,0 0.157	22,0 0.866	107,5	0,0	-7,0	0,2 0.440	VB..1102.. VB..21.5.
C4-SVQBR-13070-11	00094239	C4	16,0 0.630	40,0 1.575	13,0 0.512	70,0 2.756	47,0 1.850	4,0 0.157	25,0 0.984	107,5	0,0	-7,0	0,3 0.660	VB..1102.. VB..21.5.
C4-SVQBL-13070-11	00094231	C4	16,0 0.630	40,0 1.575	13,0 0.512	70,0 2.756	47,0 1.850	4,0 0.157	25,0 0.984	107,5	0,0	-7,0	0,3 0.660	VB..1102.. VB..21.5.
C4-SVQBR-18090-16	00094243	C4	25,0 0.984	40,0 1.575	18,0 0.709	90,0 3.543	68,0 2.677	4,5 0.177	33,0 1.299	107,5	0,0	-6,0	0,5 1.100	VB..IVC..1604 VB..IVC..33.
C4-SVQBL-18090-16	00094233	C4	25,0 0.984	40,0 1.575	18,0 0.709	90,0 3.543	68,0 2.677	4,5 0.177	33,0 1.299	107,5	0,0	-6,0	0,5 1.100	VB..IVC..1604 VB..IVC..33.
C5-SVQBR-22110-16	00094303	C5	32,0 1.260	50,0 1.969	22,0 0.866	110,0 4.331	88,0 3.465	5,0 0.197	40,0 1.575	107,5	0,0	-8,0	0,9 1.980	VB..IVC..1604 VB..IVC..33.
C5-SVQBR-27140-16	00094305	C5	40,0 1.575	50,0 1.969	27,0 1.063	140,0 5.512	119,0 4.685	6,0 0.236	50,0 1.969	107,5	0,0	-8,0	1,4 3.090	VB..IVC..1604 VB..IVC..33.
C5-SVQBL-22110-16	00094672	C5	32,0 1.260	50,0 1.969	22,0 0.866	110,0 4.331	88,0 3.465	5,0 0.197	40,0 1.575	107,5	0,0	-8,0	0,9 1.980	VB..IVC..1604 VB..IVC..33.
C5-SVQBL-27140-16	00094673	C5	40,0 1.575	50,0 1.969	27,0 1.063	140,0 5.512	119,0 4.685	6,0 0.236	50,0 1.969	107,5	0,0	-8,0	1,4 3.090	VB..IVC..1604 VB..IVC..33.
C6-SVQBR-22120-16	00094336	C6	32,0 1.260	63,0 2.480	22,0 0.866	120,0 4.724	94,0 3.701	5,0 0.197	40,0 1.575	107,5	0,0	-8,0	1,3 2.870	VB..IVC..1604 VB..IVC..33.
C6-SVQBR-35175-16	00094338	C6	50,0 1.969	63,0 2.480	35,0 1.378	175,0 6.890	152,0 5.984	9,0 0.354	63,0 2.480	107,5	0,0	-8,0	2,7 5.950	VB..IVC..1604 VB..IVC..33.
C6-SVQBL-22120-16	00094333	C6	32,0 1.260	63,0 2.480	22,0 0.866	120,0 4.724	94,0 3.701	5,0 0.197	40,0 1.575	107,5	0,0	-8,0	1,3 2.870	VB..IVC..1604 VB..IVC..33.
C6-SVQBL-35175-16	00094335	C6	50,0 1.969	63,0 2.480	35,0 1.378	175,0 6.890	152,0 5.984	9,0 0.354	63,0 2.480	107,5	0,0	-8,0	2,7 5.950	VB..IVC..1604 VB..IVC..33.

Spare Parts

For size	Insert key 	Insert screw 	Insert shim 	Shim screw 
C3	T07P-2	C02506-T07P	-	-
C4-.13.-11	T07P-2	C02506-T07P	-	-
C4-.18.-16	T15P-2	C03510-T15P	-	-
C5-.22.-16	T15P-2	C03512-T15P	171.19-620	CA3507
C5-.27.-16	T15P-2	C03512-T15P	171.19-620	CA3507
C6	T15P-2	C03512-T15P	171.19-620	CA3507

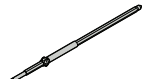
Accessories

For size	Insert clamping torque 	Replacement blade 	Shim key 	Torque key 
C3	0.9NM	T00-07P	-	T00-07P09
C4-.13.-11	0.9NM	T00-07P	-	T00-07P09
C4-.18.-16	3.0NM	T00-15P	-	T00-15P30
C5-.22.-16	3.0NM	T00-15P	9/64SMS875	T00-15P30
C5-.27.-16	3.0NM	T00-15P	9/64SMS875	T00-15P30
C6	3.0NM	T00-15P	9/64SMS875	T00-15P30

General ISO Turning
Holders

Steadyline®

MDT

Mini-Shaft™

Grooving

Parting-off

X4

Adapters
Clamping units

Accessories and
Spare parts

Workpiece
materials

C.-CTUNR/L – Toolholders for PCBN inserts TNGN, TNGX, TNMN and TNMX – Metric/ Inch

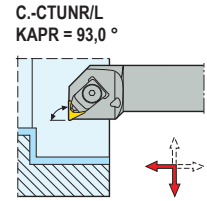
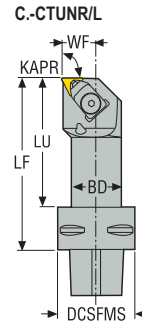
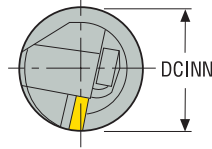

CTWS



- For inserts program, see page(s) 558, 559, 560, 561, 591
- GAMO° = Rake angle, LAMS° = Inclination angle
- CTMS = Seco-Capto™ size
- CTWS = Insert shape and size
- For holder code key, see page(s) 13-14
- Right-hand version shown
- Please check availability at www.secotools.com / Seco Online Store

Designation	Item number	CTMS	BD	DCSFMS	WF	LF	LU	DCINN	KAPR°	GAMO°	LAMS°	Weight		CTWS
												mm	kg	
C4-CTUNL-17090-11	02595983	C4	25,0 0.984	40,0 1.575	17,0 0.669	90,0 3.543	68,0 2.677	32,0 1.260	93,0	-6,0	-12,0	0,6 1.320	TN..1103.. TN..22.	
C5-CTUNL-22110-11	02595990	C5	32,0 1.260	50,0 1.969	22,0 0.866	110,0 4.331	89,0 3.504	40,0 1.575	93,0	-6,0	-12,0	1,0 2.200	TN..1103.. TN..22.	
C6-CTUNR-22110-11	02595992	C6	32,0 1.260	63,0 2.480	22,0 0.866	110,0 4.331	89,0 3.504	40,0 1.575	93,0	-6,0	-12,0	1,3 2.870	TN..1103.. TN..22.	
C6-CTUNL-22110-11	02595994	C6	32,0 1.260	63,0 2.480	22,0 0.866	110,0 4.331	89,0 3.504	40,0 1.575	93,0	-6,0	-12,0	1,3 2.870	TN..1103.. TN..22.	

Spare Parts

For size	Cantilever clamp	Clamp key	Coolant nozzle	Insert shim	Shim screw
-11	 CC14	 4SMS795	 CN6	 CTN110308	 CS2507-T07P

Accessories

For size	Shim key
-11	 T07P-2

General ISO Turning Holders
Steadyline®
MDT
Mini-Shaft™
Grooving
Parting-off
X4
Adapters Clamping units
Accessories and Spare parts
Workpiece materials

C.-DSKNR/L - PCLNR/L – Toolholders for inserts SNMA, SNMG, SNMM / CNMA, CNMG, CNMM – Metric / Inch

C.-DSKNR/L - PCLNR/L
KAPR = 75,0°

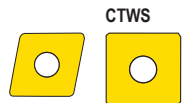
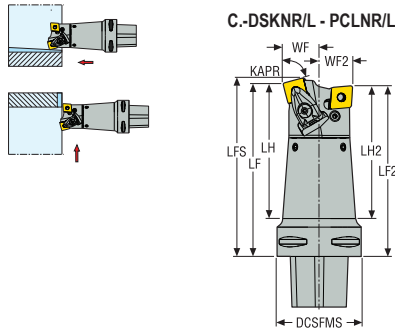

- For inserts program, see page(s) 550, 551, 552, 553, 527, 528, 529, 530, 531, 532, 533
- GAMO° = Rake angle, LAMS° = Inclination angle, CTMS = Seco-Capto™ size
- CTMS = Seco-Capto™ size
- CTWS = Insert shape and size
- Right-hand version shown
- Please check availability at www.secotools.com / Seco Online Store

Designation	Item number	CTMS	DCSFMS	LF	LF2	LFS	LH	LH2	WF	WF2	KAPR°	GAMO°	LAMS°	Weight	CTWS
				mm	mm	mm	mm	mm	mm	mm					
				Inch	Inch	Inch	Inch	Inch	Inch	Inch					lbs
C6-DSKNR2713015-PCLNL2512816	03031406	C6	63,0 2.480	130 5.118	128,0 5.039	134,0 5.276	101,5 3.996	99,5 3.917	27,0 1.063	25,0 0.984	75,0	-5,0	-10,0	0,9 1.980	SN..1506.. SN..54.
C6-DSKNL2713015-PCLNR2512816C	03032390	C6	63,0 2.480	130 5.118	128,0 5.039	134,0 5.276	101,5 3.996	99,5 3.917	27,0 1.063	25,0 0.984	75,0	-5,0	-10,0	2,3 5.070	SN..1506.. SN..54.

Spare Parts

For size	Clamp	Clamp pin	Clamp screw	Insert shim	Lever pin	Lever screw	Plug	Shim pin	Shim screw	Spring
C6	CD16-S	FP2012	L86026-T20P	PCN160412	PP6017	LS0820	P6SS6X5G	RP8286	C05010-T20P	S7010

Accessories

For size	Clamp kit	Key	Lever key
C6	CD16-S16	T20P-7L	3SMS795

General ISO Turning Holders
Steadyline®
MDT
Mini-Shaft™
Grooving
Parting-off
X4
Adapters Clamping units
Accessories and Spare parts
Workpiece materials

C.-MSKNR/L - PCLNR/L – Toolholders for inserts SNMA, SNMG, SNMM / CNMA, CNMG, CNMM – Metric/ Inch

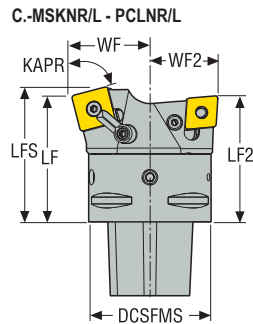

C.-MSKNR/L - PCLNR/L
KAPR = 75,0°

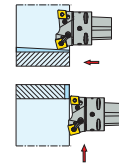

CTWS



- For inserts program, see page(s) 550, 551, 552, 553, 527, 528, 529, 530, 531, 532, 533
- GAMO° = Rake angle, LAMS° = Inclination angle CTMS = Seco-Capto™ size
- CTMS = Seco-Capto™ size
- CTWS = Insert shape and size
- Right-hand version shown
- Please check availability at www.secotools.com / Seco Online Store

Designation	Item number	CTMS	DCSFMS	LF	LF2	LFS	WF	WF2	KAPR°	GAMO°	LAMS°	Weight	CTWS
			mm Inch	mm Inch	mm Inch	mm Inch	mm Inch	mm Inch				kg lbs	
C6-MSKNR4006519-PCLNL3506516	03032391	C6	63,0 2.480	65 2.559	65,0 2.559	69,8 2.748	40,0 1.575	35,0 1.378	75,0	-5,0	-10,0	0,7 1.540	SN1906-CN1606 SN..64-CN..54
C6-MSKNL4006519-PCLNR3506516C	03032405	C6	63,0 2.480	65 2.559	65,0 2.559	69,8 2.748	40,0 1.575	35,0 1.378	75,0	-5,0	-10,0	1,5 3.310	SN1906-CN1606 SN..64-CN..54
C8-MSKNR4508019-PCLNL4508016	03032403	C8	80,0 3.150	80 3.150	80,0 3.150	85,0 3.346	45,0 1.772	45,0 1.772	75,0	-5,0	-10,0	3,3 7.280	SN1906-CN1606 SN..64-CN..54
C8-MSKNL4508019-PCLNR4508016C	03031407	C8	80,0 3.150	80 3.150	80,0 3.150	85,0 3.346	45,0 1.772	45,0 1.772	75,0	-5,0	-10,0	3,3 7.280	SN1906-CN1606 SN..64-CN..54

Spare Parts

For size	Clamp	Coolant nozzle	Insert shim	Lever pin	Lever screw	Pin	Plug	Screw	Shim pin
C6/C8	MC22	CN6	SSN190412	PP6017	LS0820	MN1920-T20P	P6SS6X5G	LD6024-T20P	RP8286

Accessories

For size	Key	Lever key
C6/C8	T20P-7L	3SMS795

General ISO Turning Holders
Steadyline®
MDT
Mini-Shaft™
Grooving
Parting-off
X4
Adapters Clamping units
Accessories and Spare parts
Workpiece materials

DWLNRL/..-C – Toolholders for PCBN inserts WNGA and WNMA – Metric

DWLNRL/..-C
KAPR = 95,0°

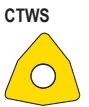
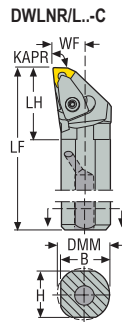
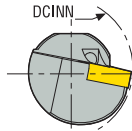
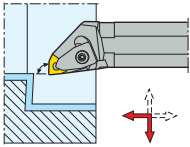

- For inserts program, see page(s) 568, 569, 570, 571, 596
- GAMO° = Rake angle, LAMS° = Inclination angle
- CTWS = Insert shape and size
- For holder code key, see page(s) 19-20
- Right-hand version shown
- * Use the right shim & the right screw for the selected insert. For details, see page 99
- Please check availability at www.secotools.com / Seco Online Store

Designation	Item number	DMM	H	B	LF	WF	LH	DCINN	KAPR°	GAMO°	LAMS°	Weight	CTWS
		mm	mm	mm	mm	mm	mm	mm				kg	
A25R-DWLNRO6-C	02598616	25,0	23	24	200	17,0	33,0	32,0	95,0	-5,0	-12,0	0,7	WN.A0604..
A25R-DWLNLO6-C	02598618	25,0	23	24	200	17,0	33,0	32,0	95,0	-5,0	-12,0	0,7	WN.A0604..
A32S-DWLNLO6-C	02598622	32,0	30	31	250	22,0	38,0	40,0	95,0	-5,0	-12,0	1,3	WN.A0604..
A25R-DWLNRO8-C	02598625	25,0	23	24	200	17,0	28,0	32,0	95,0	-5,0	-11,0	0,7	WN..0804/WN..0806*
A32S-DWLNRO8-C	02598628	32,0	30	31	250	22,0	40,0	40,0	95,0	-5,0	-11,0	1,4	WN..0804/WN..0806*
A25R-DWLNLO8-C	02598627	25,0	23	24	200	17,0	28,0	32,0	95,0	-5,0	-11,0	0,7	WN..0804/WN..0806*
A32S-DWLNLO8-C	02598629	32,0	30	31	250	22,0	40,0	40,0	95,0	-5,0	-11,0	1,4	WN..0804/WN..0806*

Spare Parts

For size	Clamp pin	Clamp screw	Floating wedge clamp	Insert shim	Shim/clamp key	Shim screw	Spring
...06	FP1508	L84017-T09P	CC09P-D11	DWD060210	T09P-2	C03007-T09P	S5608
...08	FP2012	L85021-T15P	CC12P-S12	DWD080316	T15P-2	C04008-T15P	S6912

Accessories

For size	Clamp kit	Insert clamping torque	Replacement blade	Torque key
...06	CC09P-SET	2.0NM	T00-09P	T00-09P20
...08	CC12P-SET	3.5NM	T00-15P	T00-15P35

General ISO Turning
Holders

Steadyline®

MDT

Mini-Shaft™

Grooving

Parting-off

X4

Adapters
Clamping units

Accessories and
Spare parts

Workpiece
materials

DWLNR/L – Toolholders for PCBN inserts WNGA and WNMA – Inch

General ISO Turning
Holders

Steadyline®

MDT

Mini-Shaft™

Grooving

Parting-off

X4

Adapters
Clamping units

Accessories and
Spare parts

Workpiece
materials

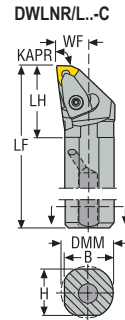

DWLNR/L..-C
KAPR = 95,0 °

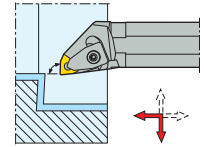







CTWS







- For inserts program, see page(s) 568, 569, 570, 571, 596
- GAMO° = Rake angle, LAMS° = Inclination angle
- CTWS = Insert shape and size
- For holder code key, see page(s) 21-22
- Right-hand version shown
- Please check availability at www.secotools.com / Seco Online Store

Designation	Item number	DMM	H	B	LF	WF	LH	DCINN	KAPR°	GAMO°	LAMS°	Weight	CTWS
		Inch	Inch	Inch	Inch	Inch	Inch	Inch				lbs	
A16-DWLNL-3-C	02605020	1.000	0.902	0.961	12.008	0.433	1.378	1.299	95,0	-5,0	-11,0	2.200	WN..33.

Spare Parts

For size	Clamp pin	Clamp screw	Floating wedge clamp	Insert shim	Shim/clamp key	Shim screw	Spring
...3	 FP1508	 L84017-T09P	 CC09P-SET	 DWD060210	 T09P-2	 C03007-T09P	 S5608

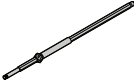
Accessories

For size	Clamp kit	Insert clamping torque	Replacement blade	Torque key
...3	 CC09P-D11	 17.7IN.LBS	 T00-09P	 T00-09P20

PCLNR/L – Toolholders for inserts CNGA, CNGG, CNMA, CNMG and CNMM – Metric

PCLNR/L
KAPR = 95,0°

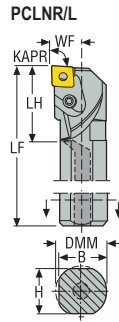
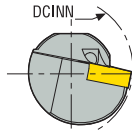
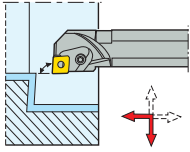

CTWS



- For inserts program, see page(s) 527, 528, 529, 530, 531, 532, 533, 575, 576
- GAMO° = Rake angle, LAMS° = Inclination angle
- CTWS = Insert shape and size
- For holder code key, see page(s) 19-20
- Right-hand version shown
- Please check availability at www.secotools.com / Seco Online Store

Designation	Item number	DMM	H	B	LF	WF	LH	DCINN	KAPR°	GAMO°	LAMS°	Weight	CTWS
		mm	mm	mm	mm	mm	mm	mm				kg	
A20R-PCLNR09	02516558	20,0	18	19	200	13,0	30,0	25,0	95,0	-6,0	-12,0	0,4	CN..0903..
A25S-PCLNR09	00092005	25,0	23	24	250	17,0	35,0	32,0	95,0	-6,0	-11,0	0,8	CN..0903..
A20R-PCLNL09	02516563	20,0	18	19	200	13,0	30,0	25,0	95,0	-6,0	-12,0	0,4	CN..0903..
A25S-PCLNL09	00092004	25,0	23	24	250	17,0	35,0	32,0	95,0	-6,0	-11,0	0,8	CN..0903..
A32T-PCLNR12	02516543	32,0	30	31	300	22,0	50,0	40,0	95,0	-6,0	-12,0	1,6	CN..1204..
A40U-PCLNR12	02516552	40,0	37	39	350	27,0	60,0	50,0	95,0	-6,0	-8,0	2,9	CN..1204..
A32T-PCLNL12	02436407	32,0	30	31	300	22,0	50,0	40,0	95,0	-6,0	-12,0	1,6	CN..1204..
A40U-PCLNL12	02436411	40,0	37	39	350	27,0	60,0	50,0	95,0	-6,0	-8,0	2,9	CN..1204..
A40U-PCLNR16	02516592	40,0	37	39	350	27,0	60,0	50,0	95,0	-6,0	-12,0	3,0	CN..1606..
A50V-PCLNR16	02516587	50,0	47	49	400	35,0	70,0	63,0	95,0	-6,0	-10,0	5,4	CN..1606..
A40U-PCLNL16	02516586	40,0	37	39	350	27,0	60,0	50,0	95,0	-6,0	-12,0	3,0	CN..1606..
A50V-PCLNL16	02516564	50,0	47	49	400	35,0	70,0	63,0	95,0	-6,0	-10,0	5,4	CN..1606..
A50V-PCLNR19	02516593	50,0	47	49	400	35,0	70,0	63,0	95,0	-6,0	-8,0	5,4	CN..1906..
A50V-PCLNL19	02516597	50,0	47	49	400	35,0	70,0	63,0	95,0	-6,0	-8,0	5,4	CN..1906..

General ISO Turning
Holders

Steadyline®

MDT

Mini-Shaft™

Grooving

Parting-off







X4

Adapters
Clamping units

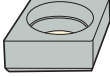





Accessories and
Spare parts

Workpiece
materials

Spare Parts

For size	Insert pin	Insert shim	Locking screw	Shim pin	Wedge clamp	Wedge key	Wedge screw
A20R...R09	 110.26-653	 -	 -	 -	 110.26-639	 2.5SMS795	 117.26-657
A25S...R09	110.26-653	-	-	-	110.26-639	2.5SMS795	117.26-657
A20R...L09	110.26-653	-	-	-	110.26-638	2.5SMS795	117.26-657
A25S...L09	110.26-653	-	-	-	110.26-638	2.5SMS795	117.26-657
A32T...R12	-	123.26-621	136.26-651	131.26-652	110.26-641	T20P-7	WS1620-T20P
A40U...R12	-	123.26-621	136.26-651	131.26-652	110.26-641	3SMS795	117.26-655
A32T...L12	-	123.26-621	136.26-651	131.26-652	110.26-640	T20P-7	WS1620-T20P
A40U...L12	-	123.26-621	136.26-651	131.26-652	110.26-640	3SMS795	117.26-655
A40U...R16	-	123.26-625	136.26-651	123.26-650	110.26-643.5	T25P-7	WS2325-T25P
A50V...R16	-	123.26-625	136.26-651	123.26-650	110.26-643.5	T25P-7	WS2325-T25P
A40U...L16	-	123.26-625	136.26-651	123.26-650	110.26-642.5	T25P-7	WS2325-T25P
A50V...L16	-	123.26-625	136.26-651	123.26-650	110.26-642.5	T25P-7	WS2325-T25P
A50V...R19	-	123.26-627	131.26-651	131.26-653	110.26-643	4SMS795	170.26-655
A50V...L19	-	123.26-627	131.26-651	131.26-653	110.26-642	4SMS795	170.26-655

Accessories

For size	Insert clamping torque	Insert key	Locking key	Punch	Replacement blade	Torque key
						
A20R...R09	3.0NM	2SMS795	-	-	-	H00-2530
A25S...R09	3.0NM	2SMS795	-	-	-	H00-2530
A20R...L09	3.0NM	2SMS795	-	-	-	H00-2530
A25S...L09	3.0NM	2SMS795	-	-	-	H00-2530
A32T...R12	3.5NM	-	3SMS795	117.26-687	T00-20P	T00-20P35
A40U...R12	5.0NM	-	-	117.26-687	H00T-3.0	H00T-3050
A32T...L12	3.5NM	-	3SMS795	117.26-687	T00-20P	T00-20P35
A40U...L12	5.0NM	-	-	117.26-687	H00T-3.0	H00T-3050
A40U...R16	5.0NM	-	3SMS795	117.26-687	T00T-25P	T00T-25P50
A50V...R16	5.0NM	-	3SMS795	117.26-687	T00T-25P	T00T-25P50
A40U...L16	5.0NM	-	3SMS795	117.26-687	T00T-25P	T00T-25P50
A50V...L16	5.0NM	-	3SMS795	117.26-687	T00T-25P	T00T-25P50
A50V...R19	6.0NM	-	-	117.26-687	H00T-4.0	H00T-4060
A50V...L19	6.0NM	-	-	117.26-687	H00T-4.0	H00T-4060

General ISO Turning Holders
Steadyline®
MDT
Mini-Shaft™
Grooving
Parting-off
X4
Adapters Clamping units
Accessories and Spare parts
Workpiece materials

PCLNR/L – Toolholders for inserts CNGA, CNGG, CNGM, CNMA, CNMG and CNMM – Metric

PCLNR/L
KAPR = 95,0°

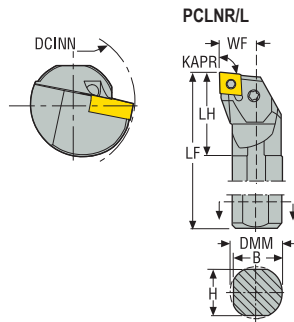
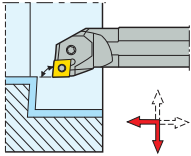

- For inserts program, see page(s) 527, 528, 529, 530, 531, 532, 533, 575, 576, 597
- GAMO° = Rake angle, LAMS° = Inclination angle
- CTWS = Insert shape and size
- For holder code key, see page(s) 19-20
- Right-hand version shown
- Please check availability at www.secotools.com / Seco Online Store

Designation	Item number	DMM	H	B	LF	WF	LH	DCINN	KAPR°	GAMO°	LAMS°	Weight	CTWS
		mm	mm	mm	mm	mm	mm	mm				kg	
S25T-PCLNR12	02411147	25,0	23	23	300	17,0	40,0	32,0	95,0	-6,0	-10,0	1,1	CN..1204..
S32U-PCLNR12	02411149	32,0	30	30	350	22,0	50,0	40,0	95,0	-6,0	-10,0	2,1	CN..1204..
S40V-PCLNR12	02411151	40,0	37	38	400	27,0	60,0	50,0	95,0	-6,0	-10,0	3,7	CN..1204..
S25T-PCLNL12	02411148	25,0	23	23	300	17,0	40,0	32,0	95,0	-6,0	-10,0	1,1	CN..1204..
S32U-PCLNL12	02411150	32,0	30	30	350	22,0	50,0	40,0	95,0	-6,0	-10,0	2,1	CN..1204..
S40V-PCLNL12	02411152	40,0	37	38	400	27,0	60,0	50,0	95,0	-6,0	-10,0	3,7	CN..1204..

Spare Parts

For size	Insert lever	Insert shim	Lever key	Lever screw	Punch	Shim pin
S25T-..12	PP4613	-	2.5SMS795	LS0613	-	-
S..UV-..12	PP4713	PCN120308	3SMS795	LS0818	MP0912	RP6757

Accessories

For size	Insert clamping torque	Torque key
S25T-..12	3.0NM	H00-2530
S..UV-..12	-	-

General ISO Turning
Holders

Steadyline®

MDT

Mini-Shaft™

Grooving

Parting-off

X4

Adapters
Clamping units

Accessories and
Spare parts

Workpiece
materials

PDUNR/L – Toolholders for inserts DNGA, DNGG, DNGM, DNMA, DNMG, DNMM, DNMU and DNMX – Metric

General ISO Turning
Holders

Steadyline®

MDT

Mini-Shaft™

Grooving

Parting-off

X4

Adapters
Clamping units

Accessories and
Spare parts

Workpiece
materials

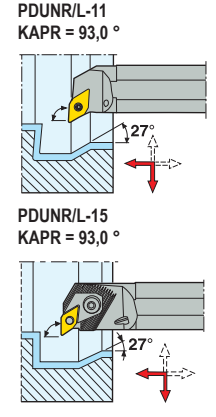
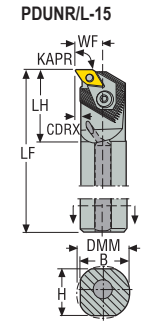
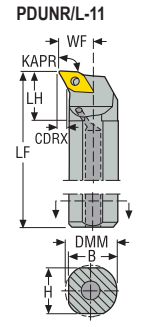
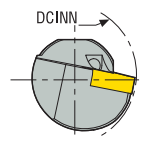

CTWS



- For inserts program, see page(s) 537, 538, 539, 540, 541, 579, 580, 598
- GAMO° = Rake angle, LAMS° = Inclination angle
- CTWS = Insert shape and size
- For holder code key, see page(s) 19-20
- Right-hand version shown
- * Use the right shim & the right screw for the selected insert. For details, see page 99
- Please check availability at www.secotools.com / Seco Online Store

Designation	Item number	DMM	H	B	LF	WF	LH	CDX	DCINN	KAPR°	GAMO°	LAMS°	Weight	CTWS
		mm	mm	mm	mm	mm	mm	mm	mm				kg	
A25R-PDUNR11	00083820	25,0	23	24	200	17,0	35,0	4,0	32,0	93,0	-5,0	-13,0	0,7	DN..1104..
A32S-PDUNR11	00083832	32,0	30	31	250	22,0	37,0	6,0	40,0	93,0	-5,0	-11,0	1,4	DN..1104..
A25R-PDUNL11	00083821	25,0	23	24	200	17,0	35,0	4,0	32,0	93,0	-5,0	-13,0	0,7	DN..1104..
A32S-PDUNL11	00083833	32,0	30	31	250	22,0	37,0	6,0	40,0	93,0	-5,0	-11,0	1,4	DN..1104..
A32T-PDUNR15	02516544	32,0	30	31	300	22,0	50,0	5,0	40,0	93,0	-6,0	-15,0	1,6	DN.1504/DN..1506*
A40U-PDUNR15	02516547	40,0	37	39	350	27,0	60,0	5,0	50,0	93,0	-6,0	-14,0	2,9	DN.1504/DN..1506*
A50V-PDUNR15	02516557	50,0	47	49	400	35,0	70,0	5,0	63,0	93,0	-6,0	-11,0	5,3	DN.1504/DN..1506*
A32T-PDUNL15	02516554	32,0	30	31	300	22,0	50,0	5,0	40,0	93,0	-6,0	-15,0	1,6	DN.1504/DN..1506*
A40U-PDUNL15	02516553	40,0	37	39	350	27,0	60,0	5,0	50,0	93,0	-6,0	-14,0	2,9	DN.1504/DN..1506*
A50V-PDUNL15	02516561	50,0	47	49	400	35,0	70,0	5,0	63,0	93,0	-6,0	-11,0	5,3	DN.1504/DN..1506*

Spare Parts

For size	Insert key	Insert pin	Insert shim	Locking screw	Shim pin	Wedge clamp	Wedge key	Wedge screw
A25R-11	T09P-2	PL1403-T09P	DAE110312	-	-	-	-	-
A32S-11	T09P-2	PL1403-T09P	DAE110312	-	-	-	-	-
A32T-R15	-	-	PDD150312	136.26-651	131.26-652	171.66-641	T25P-7	WS2325-T25P
A40U-R15	-	-	PDD150312	136.26-651	131.26-652	171.66-641	T25P-7	WS2325-T25P
A50V-R15	-	-	PDD150312	136.26-651	131.26-652	171.66-641	4SMS795	170.26-655
A32T-L15	-	-	PDD150312	136.26-651	131.26-652	171.66-640	T25P-7	WS2325-T25P
A40U-L15	-	-	PDD150312	136.26-651	131.26-652	171.66-640	T25P-7	WS2325-T25P
A50V-L15	-	-	PDD150312	136.26-651	131.26-652	171.66-640	4SMS795	170.26-655

Accessories

For size	Insert clamping torque	Locking key	Punch	Replacement blade	Torque key
A25R-11	-	-	-	-	-
A32S-11	-	-	-	-	-
A32T-R15	5.0NM	3SMS795	117.26-687	T00T-25P	T00T-25P50
A40U-R15	5.0NM	3SMS795	117.26-687	T00T-25P	T00T-25P50
A50V-R15	6.0NM	3SMS795	117.26-687	H00T-4.0	H00T-4060
A32T-L15	5.0NM	3SMS795	117.26-687	T00T-25P	T00T-25P50
A40U-L15	5.0NM	3SMS795	117.26-687	T00T-25P	T00T-25P50
A50V-L15	6.0NM	3SMS795	117.26-687	H00T-4.0	H00T-4060

- General ISO Turning Holders
- Steadyline®
- MDT
- Mini-Shaft™
- Grooving
- Parting-off
- X4
- Adapters Clamping units
- Accessories and Spare parts
- Workpiece materials

PDUNR/L – Toolholders for inserts DNGA, DNGG, DNGM, DNMA, DNMG, DNMM, DNMU and DNMX – Metric

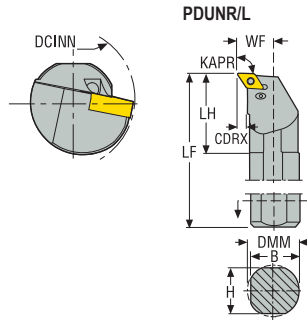

PDUNR/L
KAPR = 93,0 °

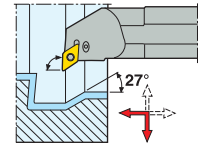

CTWS



- For inserts program, see page(s) 537, 538, 539, 540, 541, 579, 580, 598
- GAMO° = Rake angle, LAMS° = Inclination angle
- CTWS = Insert shape and size
- For holder code key, see page(s) 19-20
- Right-hand version shown
- * Use the right shim & the right screw for the selected insert. For details, see page 99
- Please check availability at www.secotools.com / Seco Online Store

Designation	Item number	DMM	H	B	LF	WF	LH	CDX	DCINN	KAPR°	GAMO°	LAMS°	Weight	CTWS
		mm	mm	mm	mm	mm	mm	mm	mm				kg	
S25T-PDUNR11	02411153	25,0	23	23	300	17,0	45,0	4,5	32,0	93,0	-6,0	-13,0	1,1	DN..1104..
S32U-PDUNR11	02411155	32,0	30	30	350	22,0	50,0	6,0	40,0	93,0	-6,0	-11,0	2,1	DN..1104..
S25T-PDUNL11	02411154	25,0	23	23	300	17,0	45,0	4,5	32,0	93,0	-6,0	-13,0	1,1	DN..1104..
S32U-PDUNL11	02411156	32,0	30	30	350	22,0	50,0	6,0	40,0	93,0	-6,0	-11,0	2,1	DN..1104..
S32U-PDUNR15	02411157	32,0	30	30	350	22,0	50,0	6,0	40,0	93,0	-6,0	-13,0	2,1	DN.1504/DN..1506*
S40V-PDUNR15	02411159	40,0	38	38	400	27,0	55,0	7,0	48,0	93,0	-6,0	-10,0	3,7	DN.1504/DN..1506*
S50W-PDUNR15	02411161	50,0	47	49	450	35,0	70,0	10,0	61,0	93,0	-6,0	-10,0	6,4	DN.1504/DN..1506*
S32U-PDUNL15	02411158	32,0	30	30	350	22,0	50,0	6,0	40,0	93,0	-6,0	-13,0	2,1	DN.1504/DN..1506*
S40V-PDUNL15	02411160	40,0	38	38	400	27,0	55,0	7,0	48,0	93,0	-6,0	-10,0	3,7	DN.1504/DN..1506*
S50W-PDUNL15	02207910	50,0	47	49	450	35,0	70,0	10,0	61,0	93,0	-6,0	-10,0	6,4	DN.1504/DN..1506*

Spare Parts

For size	Insert lever	Insert shim	Lever key	Lever screw	Punch	Shim pin
S25T-...11	PP3611	-	2SMS795	LS0512	-	-
S32U-...11	PP3512	PDN110308	2.5SMS795	LS0616	MP0912	RP5153
...15	PP4716	PDN150308	3SMS795	LS0822	MP0912	RP6757

Accessories

For size	Insert clamping torque	Replacement blade	Torque key
S25T-...11	2.0NM	H00-3.0	H00-3020
S32U-...11	3.0NM	-	H00-2530
...15	-	-	-

General ISO Turning Holders
Steadyline®
MDT
Mini-Shaft™
Grooving
Parting-off
X4
Adapters Clamping units
Accessories and Spare parts
Workpiece materials

PSKNR/L – Toolholders for inserts SNGA, SNMA, SNMG and SNMM – Metric

PSKNR/L
KAPR = 75,0°

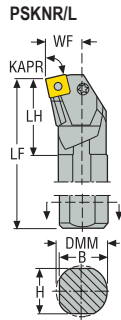
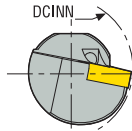
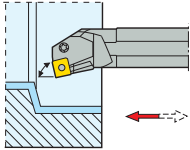

CTWS



- For inserts program, see page(s) 550, 551, 552, 553, 585
- GAMO° = Rake angle, LAMS° = Inclination angle
- CTWS = Insert shape and size
- For holder code key, see page(s) 19-20
- Right-hand version shown
- Please check availability at www.secotools.com / Seco Online Store

Designation	Item number	DMM	H	B	LF	WF	LH	DCINN	KAPR°	GAMO°	LAMS°	Weight	CTWS
		mm	mm	mm	mm	mm	mm	mm				kg	
S25T-PSKNR12	00734327	25,0	23	24	300	16,88	43,0	30,0	75,0	-6,0	-10,0	1,1	SN..1204..
S32U-PSKNR12	02411165	32,0	30	30	350	22,0	52,0	40,0	75,0	-6,0	-10,0	2,1	SN..1204..
S40V-PSKNR12	02411167	40,0	38	38	400	27,0	58,0	48,0	75,0	-6,0	-10,0	3,8	SN..1204..
S25T-PSKNL12	02411162	25,0	23	24	300	16,88	43,0	30,0	75,0	-6,0	-10,0	1,1	SN..1204..
S32U-PSKNL12	02411166	32,0	30	30	350	22,0	52,0	40,0	75,0	-6,0	-10,0	2,1	SN..1204..
S40V-PSKNL12	02411169	40,0	38	38	400	27,0	58,0	48,0	75,0	-6,0	-10,0	3,8	SN..1204..

Spare Parts

For size	Insert lever	Insert shim	Lever key	Lever screw	Punch	Shim pin
S25T-...12	PP4613	-	2.5SMS795	LS0613	-	-
S32U-...12	PP4713	PSN120312	3SMS795	LS0816	MP0912	RP6757
S40V-...12	PP4713	PSN120312	3SMS795	LS0816	MP0912	RP6757

Accessories

For size	Insert clamping torque	Torque key
S25T-...12	3.0NM	H00-2530
S32U-...12	-	-
S40V-...12	-	-

PTFNR/L – Toolholders for inserts TNGA, TNMA, TNMG and TNMM – Metric

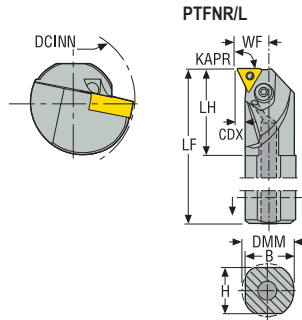

PTFNR/L A20, A25
KAPR = 90,0 °

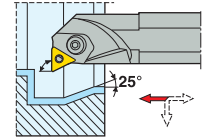

PTFNR/L A32, A40, A50
KAPR = 90,0 °

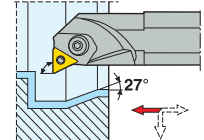

CTWS











- For inserts program, see page(s) 558, 559, 560, 561, 590
- GAMO° = Rake angle, LAMS° = Inclination angle
- CTWS = Insert shape and size
- For holder code key, see page(s) 19-20
- Right-hand version shown
- Please check availability at www.secotools.com / Seco Online Store





Designation	Item number	DMM	H	B	LF	WF	LH	CDX	DCINN	KAPR°	GAMO°	LAMS°	Weight	CTWS
		mm	mm	mm	mm	mm	mm	mm	mm				kg	
A20R-PTFNR11	00039881	20,0	18	19	200	13,0	32,0	2,5	25,0	90,0	-6,0	-12,0	0,4	TN..1103..
A20R-PTFNL11	00039883	20,0	18	19	200	13,0	32,0	2,5	25,0	90,0	-6,0	-12,0	0,4	TN..1103..
A20R-PTFNR16	00039884	20,0	18	19	200	13,0	30,0	2,5	25,0	90,0	-6,0	-15,0	0,4	TN..1604..
A25S-PTFNR16	00039889	25,0	23	24	250	17,0	35,0	4,0	32,0	90,0	-6,0	-13,0	0,8	TN..1604..
A20R-PTFNL16	00039888	20,0	18	19	200	13,0	30,0	2,5	25,0	90,0	-6,0	-15,0	0,4	TN..1604..
A25S-PTFNL16	00039890	25,0	23	24	250	17,0	35,0	4,0	32,0	90,0	-6,0	-13,0	0,7	TN..1604..
A32T-PTFNR16	02516533	32,0	30	31	300	22,0	50,0	3,5	40,0	90,0	-6,0	-10,0	1,6	TN..1604..
A40U-PTFNR16	02516545	40,0	37	39	350	27,0	60,0	5,0	50,0	90,0	-6,0	-10,0	2,9	TN..1604..
A32T-PTFNL16	00090740	32,0	30	31	300	22,0	50,0	3,5	40,0	90,0	-6,0	-10,0	1,6	TN..1604..
A40U-PTFNL16	02201285	40,0	37	39	350	27,0	60,0	5,0	50,0	90,0	-6,0	-10,0	2,9	TN..1604..
A40U-PTFNR22	02516551	40,0	37	39	350	27,0	60,0	5,0	50,0	90,0	-6,0	-10,0	2,9	TN..2204..
A50V-PTFNR22	00734093	50,0	47	49	400	35,0	70,0	7,0	63,0	90,0	-6,0	-8,0	5,3	TN..2204..
A40U-PTFNL22	00130162	40,0	37	39	350	27,0	60,0	5,0	50,0	90,0	-6,0	-10,0	2,9	TN..2204..
A50V-PTFNL22	02201283	50,0	47	49	400	35,0	70,0	7,0	63,0	90,0	-6,0	-8,0	5,3	TN..2204..

General ISO Turning Holders
Steadyline®
MDT
Mini-Shaft™
Grooving
Parting-off
X4
Adapters Clamping units
Accessories and Spare parts
Workpiece materials

Spare Parts

For size	Insert pin 	Insert shim 	Locking screw 	Shim pin 	Wedge/locking key 	Wedge clamp 	Wedge key 	Wedge screw 
...R11	118.26-650	-	-	-	-	110.26-638	2.5SMS795	117.26-657
...L11	118.26-650	-	-	-	-	110.26-639	2.5SMS795	117.26-657
A20R...R16	136.26-653	-	-	-	-	110.26-640.1	T20P-7	WS1920-T20P
A25S...R16	136.26-653	-	-	-	-	110.26-640.1	T20P-7	WS1920-T20P
A20R...L16	136.26-653	-	-	-	-	110.26-641.1	T20P-7	WS1920-T20P
A25S...L16	136.26-653	-	-	-	-	110.26-641.1	T20P-7	WS1920-T20P
A32T...R16	-	136.26-621	136.26-651	136.26-650	3SMS795	110.26-640.1	-	117.26-655
A40U...R16	-	136.26-621	136.26-651	136.26-650	3SMS795	110.26-640.1	-	117.26-655
A32T...L16	-	136.26-621	136.26-651	136.26-650	3SMS795	110.26-641.1	-	117.26-655
A40U...L16	-	136.26-621	136.26-651	136.26-650	3SMS795	110.26-641.1	-	117.26-655
A40U...R22	-	136.26-624	136.26-651	136.26-652	-	110.26-642.1	4SMS795	170.26-655
A50V...R22	-	136.26-624	136.26-651	136.26-652	-	110.26-642.1	4SMS795	170.26-655
A40U...L22	-	136.26-624	136.26-651	136.26-652	-	110.26-643.1	4SMS795	170.26-655
A50V...L22	-	136.26-624	136.26-651	136.26-652	-	110.26-643.1	4SMS795	170.26-655

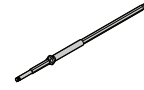
Accessories

For size	Insert clamping torque 	Insert key 	Punch 	Replacement blade 	Shim key 	Torque key 
...R11	3.0NM	2SMS795	-	-	-	H00-2530
...L11	3.0NM	2SMS795	-	-	-	H00-2530
A20R...R16	3.5NM	2.5SMS795	-	T00-20P	-	T00-20P35
A25S...R16	3.5NM	2.5SMS795	-	T00-20P	-	T00-20P35
A20R...L16	3.5NM	2.5SMS795	-	T00-20P	-	T00-20P35
A25S...L16	3.5NM	2.5SMS795	-	T00-20P	-	T00-20P35
A32T...R16	5.0NM	-	117.26-686	H00T-3.0	-	H00T-3050
A40U...R16	5.0NM	-	117.26-686	H00T-3.0	-	H00T-3050
A32T...L16	5.0NM	-	117.26-686	H00T-3.0	-	H00T-3050
A40U...L16	5.0NM	-	117.26-686	H00T-3.0	-	H00T-3050
A40U...R22	6.0NM	-	117.26-687	H00T-4.0	3SMS795	H00T-4060
A50V...R22	6.0NM	-	117.26-687	H00T-4.0	3SMS795	H00T-4060
A40U...L22	6.0NM	-	117.26-687	H00T-4.0	3SMS795	H00T-4060
A50V...L22	6.0NM	-	117.26-687	H00T-4.0	3SMS795	H00T-4060

General ISO Turning Holders
Steadyline®
MDT
Mini-Shaft™
Grooving
Parting-off
X4
Adapters Clamping units
Accessories and Spare parts
Workpiece materials

PVLNR/L and PVPNR/L – Toolholders for inserts VNMU – Metric

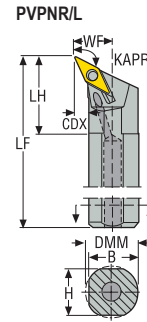
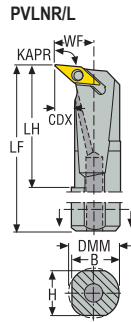
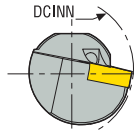

PVLNR/L
KAPR = 95,0 °

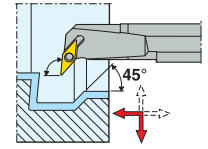

PVPNR/L
KAPR = 117,5 °

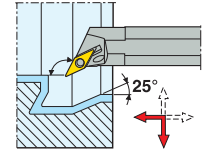

CTWS



- For inserts program, see page(s) 565, 566
- GAMO° = Rake angle, LAMS° = Inclination angle
- CTWS = Insert shape and size
- For holder code key, see page(s) 19-20
- Right-hand version shown
- Please check availability at www.secotools.com / Seco Online Store

Designation	Item number	DMM	H	B	LF	WF	LH	CDX	DCINN	KAPR°	GAMO°	LAMS°	Weight	CTWS
		mm	mm	mm	mm	mm	mm	mm	mm				kg	
A25R-PVLNR13	00083566	25,0	23	24	200	18,0	57,0	9,5	32,0	95,0	-5,0	-14,0	0,6	VNMU1304..
A32S-PVLNR13	00091720	32,0	30	31	250	23,0	50,0	6,5	40,0	95,0	-5,0	-14,0	1,3	VNMU1304..
A25R-PVLNL13	00083568	25,0	23	24	200	18,0	57,0	9,5	32,0	95,0	-5,0	-14,0	0,6	VNMU1304..
A32S-PVLNL13	00091721	32,0	30	31	250	23,0	50,0	6,5	40,0	95,0	-5,0	-14,0	1,3	VNMU1304..
A25R-PVPNR13	00091722	25,0	23	24	200	17,0	34,0	4,0	32,0	117,5	-5,0	-19,0	0,7	VNMU1304..
A32S-PVPNR13	00089737	32,0	30	31	250	22,0	35,0	5,5	40,0	117,5	-5,0	-15,5	1,3	VNMU1304..
A25R-PVPNL13	00091723	25,0	23	24	200	17,0	34,0	4,0	32,0	117,5	-5,0	-19,0	0,7	VNMU1304..
A32S-PVPNL13	00089738	32,0	30	31	250	22,0	35,0	5,5	40,0	117,5	-5,0	-15,5	1,3	VNMU1304..

Spare Parts

For size	Insert key	Insert pin	Insert shim
A25R-...13	T09P-2	PL1403-T09P	PVN130308
A32S-...13	T09P-2	PL1403-T09P	PVN130308

General ISO Turning Holders
Steadyline®
MDT
Mini-Shaft™
Grooving
Parting-off
X4
Adapters Clamping units
Accessories and Spare parts
Workpiece materials

PVLNR/L and PVPNR/L – Toolholders for inserts VNMU – Inch

PVLNR/L
KAPR = 95,0°

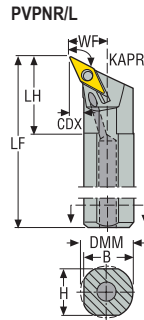
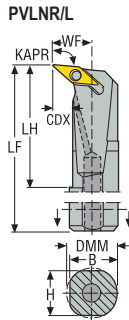
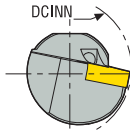
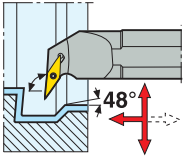

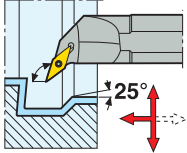

PVPNR/L
KAPR = 117,5°



- For inserts program, see page(s) 565, 566
- GAMO° = Rake angle, LAMS° = Inclination angle
- CTWS = Insert shape and size
- For holder code key, see page(s) 21-22
- Right-hand version shown
- Please check availability at www.secotools.com / Seco Online Store

Designation	Item number	DMM	H	B	LF	WF	LH	DCINN	KAPR°	GAMO°	LAMS°	Weight	CTWS
		Inch	Inch	Inch	Inch	Inch	Inch	Inch				lbs	
A16-PVLNR-2.5	00015229	1.000	0.866	0.906	12.000	0.640	1.000	1.200	95,0	-3,0	-12,0	2.430	VNMU2.53.
A16-PVPNR-2.5	00015234	1.000	0.866	0.906	12.000	0.750	1.098	1.300	117,5	-3,0	-12,0	2.430	VNMU2.53.
A16-PVPNL-2.5	00015235	1.000	0.866	0.906	12.000	0.750	1.098	1.300	117,5	-3,0	-12,0	2.430	VNMU2.53.

Spare Parts

For size	Insert key	Insert pin	Insert shim
...2.5	 T09P-2	 PL1403-T09P	 PVN2.522

General ISO Turning
Holders

Steadyline®

MDT

Mini-Shaft™

Grooving

Parting-off

X4

Adapters
Clamping units

Accessories and
Spare parts

Workpiece
materials

PWLNRL/L – Toolholders for inserts WNGA, WNGG, WNMA, WNMG and WNMM – Metric

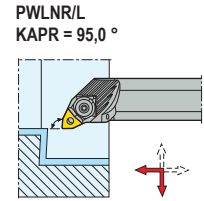
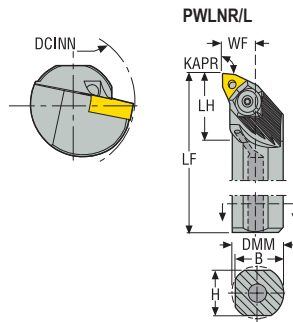

CTWS





- For inserts program, see page(s) 568, 569, 570, 571, 596
- GAMO° = Rake angle, LAMS° = Inclination angle
- CTWS = Insert shape and size
- For holder code key, see page(s) 19-20
- Right-hand version shown
- * Use the right shim & the right screw for the selected insert. For details, see page 99
- Please check availability at www.secotools.com / Seco Online Store

Designation	Item number	DMM	H	B	LF	WF	LH	DCINN	KAPR°	GAMO°	LAMS°	Weight	CTWS
		mm	mm	mm	mm	mm	mm	mm				kg	
A20Q-PWLNRL06	75036892	20,0	18	19	180	13,0	27,0	25,0	95,0	-5,0	-14,0	0,4	WN..0604..
A25R-PWLNRL06	75036894	25,0	23	24	200	17,0	30,0	32,0	95,0	-5,0	-12,0	0,6	WN..0604..
A32S-PWLNRL06	75036896	32,0	30	31	250	22,0	31,0	40,0	95,0	-5,0	-12,0	1,3	WN..0604..
A40T-PWLNRL06	75036898	40,0	37	39	300	27,0	40,0	50,0	95,0	-5,0	-12,0	2,5	WN..0604..
A20Q-PWLNRL06	75036893	20,0	18	19	180	13,0	27,0	25,0	95,0	-5,0	-14,0	0,4	WN..0604..
A25R-PWLNRL06	75036895	25,0	23	24	200	17,0	30,0	32,0	95,0	-5,0	-12,0	0,7	WN..0604..
A32S-PWLNRL06	75036897	32,0	30	31	250	22,0	31,0	40,0	95,0	-5,0	-12,0	1,3	WN..0604..
A40T-PWLNRL06	75036899	40,0	37	39	300	27,0	40,0	50,0	95,0	-5,0	-12,0	2,5	WN..0604..
A25R-PWLNRL08	75065808	25,0	23	24	200	17,0	30,0	32,0	95,0	-5,0	-11,0	0,7	WN..0804/WN..0806*
A32S-PWLNRL08	75065810	32,0	30	31	250	22,0	31,0	40,0	95,0	-5,0	-11,0	1,3	WN..0804/WN..0806*
A40T-PWLNRL08	75065812	40,0	37	39	300	27,0	35,0	50,0	95,0	-5,0	-14,0	2,5	WN..0804/WN..0806*
A25R-PWLNRL08	75065809	25,0	23	24	200	17,0	30,0	32,0	95,0	-5,0	-11,0	0,7	WN..0804/WN..0806*
A32S-PWLNRL08	75065811	32,0	30	31	250	22,0	31,0	40,0	95,0	-5,0	-11,0	1,3	WN..0804/WN..0806*
A40T-PWLNRL08	75065813	40,0	37	39	300	27,0	35,0	50,0	95,0	-5,0	-14,0	2,5	WN..0804/WN..0806*

Spare Parts

For size	Insert shim	Setting screw	Shim pin	Wedge clamp	Wedge key	Wedge screw
A20Q-...06	WAI060212	L82511-T07P	PP1209-T09P	WNW06HD	T20P-7	WS1620-T20P
A25R-...06	WAI060212	L82511-T07P	PP1209-T09P	WNW06HD	T20P-7	WS1920-T20P
A32S-...06	WAE060312	L82511-T07P	PP1409-T09P	WNW06HD	T20P-7	WS1920-T20P
A40T-...06	WAE060312	L82511-T07P	PP1409-T09P	WNW06HD	T20P-7	WS1920-T20P
A25R-...08	WAI080312	L82511-T07P	PP1415-T15P	WNW08HD	T25P-7	WS2325-T25P
A32S-...08	WAI080312	L82511-T07P	PP1415-T15P	WNW08HD	T25P-7	WS2325-T25P
A40T-...08	WAI080312	L82511-T07P	PP1415-T15P	WNW08HD	T25P-7	WS2325-T25P

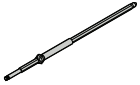
Accessories

For size	Insert clamping torque 	Replacement blade 	Shim key 	Torque key 
A20Q...06	3.5NM	T00-20P	T09P-2	T00-20P35
A25R...06	3.5NM	T00-20P	T09P-2	T00-20P35
A32S...06	3.5NM	T00-20P	T09P-2	T00-20P35
A40T...06	3.5NM	T00-20P	T09P-2	T00-20P35
A25R...08	5.0NM	T00T-25P	T15P-2	T00T-25P50
A32S...08	5.0NM	T00T-25P	T15P-2	T00T-25P50
A40T...08	5.0NM	T00T-25P	T15P-2	T00T-25P50

- General ISO Turning Holders
- Steadyline®
- MDT
- Mini-Shaft™
- Grooving
- Parting-off
- X4
- Adapters Clamping units
- Accessories and Spare parts
- Workpiece materials

Toolholders for inserts CCGT, CCGW, CCMT and CCMW – Metric

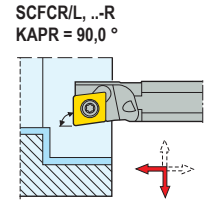
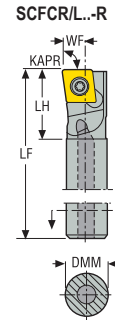
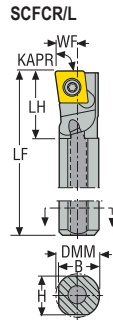
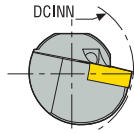

CTWS





- For inserts program, see page(s) 522, 523, 524, 525, 573, 574, 597, 599
- GAMO° = Rake angle, LAMS° = Inclination angle
- CTWS = Insert shape and size
- For holder code key, see page(s) 19-20
- Right-hand version shown
- Please check availability at www.secotools.com / Seco Online Store

Designation	Item number	DMM	H	B	LF	WF	LH	DCINN	KAPR°	GAMO°	LAMS°	Weight	CTWS
		mm	mm	mm	mm	mm	mm	mm				kg	
A08K-SCFCR06	00093710	8,0	7	8	125	5,0	12,0	10,0	90,0	0,0	-11,0	0,1	CC..0602..
A08K-SCFCR06-R	02516556	8,0	-	-	125	5,0	12,0	10,0	90,0	0,0	-11,0	0,1	CC..0602..
A10L-SCFCR06	00093712	10,0	9	10	140	7,0	18,0	13,0	90,0	0,0	-11,0	0,1	CC..0602..
A10L-SCFCR06-R	02516568	10,0	-	-	140	7,0	18,0	13,0	90,0	0,0	-11,0	0,1	CC..0602..
A08K-SCFCL06	00093711	8,0	7	8	125	5,0	12,0	10,0	90,0	0,0	-11,0	0,1	CC..0602..
A08K-SCFCL06-R	02516589	8,0	-	-	125	5,0	12,0	10,0	90,0	0,0	-11,0	0,1	CC..0602..
A10L-SCFCL06	00093713	10,0	9	10	140	7,0	18,0	13,0	90,0	0,0	-11,0	0,1	CC..0602..
A10L-SCFCL06-R	02516595	10,0	-	-	140	7,0	18,0	13,0	90,0	0,0	-11,0	0,1	CC..0602..
A12N-SCFCR09	00093714	12,0	11	12	160	9,0	20,0	17,0	90,0	0,0	-11,0	0,2	CC..09T3..
A12N-SCFCR09-R	02516559	12,0	-	-	160	9,0	20,0	17,0	90,0	0,0	-11,0	0,2	CC..09T3..
A16Q-SCFCR09	00093716	16,0	15	16	180	11,0	22,0	22,0	90,0	0,0	-5,0	0,3	CC..09T3..
A16Q-SCFCR09-R	02516585	16,0	-	-	180	11,0	22,0	22,0	90,0	0,0	-5,0	0,3	CC..09T3..
A20R-SCFCR09	00093718	20,0	18	19	200	13,0	32,0	25,0	90,0	0,0	-5,0	0,4	CC..09T3..
A20R-SCFCR09-R	02516601	20,0	-	-	200	13,0	32,0	25,0	90,0	0,0	-5,0	0,4	CC..09T3..
A12N-SCFCL09	00093715	12,0	11	12	160	9,0	20,0	17,0	90,0	0,0	-11,0	0,2	CC..09T3..
A12N-SCFCL09-R	02516590	12,0	-	-	160	9,0	20,0	17,0	90,0	0,0	-11,0	0,2	CC..09T3..
A16Q-SCFCL09	00093717	16,0	15	16	180	11,0	22,0	22,0	90,0	0,0	-5,0	0,3	CC..09T3..
A16Q-SCFCL09-R	02516602	16,0	-	-	180	11,0	22,0	22,0	90,0	0,0	-5,0	0,3	CC..09T3..
A20R-SCFCL09	00093719	20,0	18	19	200	13,0	32,0	25,0	90,0	0,0	-5,0	0,4	CC..09T3..
A20R-SCFCL09-R	00734207	20,0	-	-	200	13,0	32,0	25,0	90,0	0,0	-5,0	0,4	CC..09T3..

Spare Parts

For size	Insert key	Insert screw
A08K-...06/R	T07P-2	C02505-T07P
A10L-...06/R	T07P-2	C02506-T07P
A12N-...09/R	T15P-2	C04008-T15P
A16Q-...09/R	T15P-2	C04008-T15P
A20R-...09/R	T15P-2	C04008-T15P

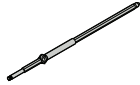
Accessories

For size	Insert clamping torque 	Replacement blade 	Torque key 
A08K...06/R	0.9NM	T00-07P	T00-07P09
A10L...06/R	0.9NM	T00-07P	T00-07P09
A12N...09/R	3.5NM	T00-15P	T00-15P35
A16Q...09/R	3.5NM	T00-15P	T00-15P35
A20R...09/R	3.5NM	T00-15P	T00-15P35

- General ISO Turning Holders
- Steadyline®
- MDT
- Mini-Shaft™
- Grooving
- Parting-off
- X4
- Adapters Clamping units
- Accessories and Spare parts
- Workpiece materials

SCFCR/L – Toolholders for inserts CCGT, CCGW, CCMT and CCMW – Metric

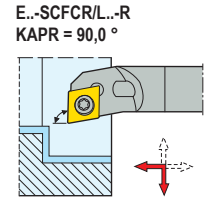
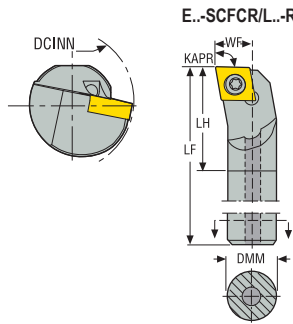

CTWS



- For inserts program, see page(s) 522, 523, 524, 525, 573, 574, 597, 599
- GAMO° = Rake angle, LAMS° = Inclination angle
- CTWS = Insert shape and size
- For holder code key, see page(s) 19-20
- E = Solid carbide shank
- Right-hand version shown
- Please check availability at www.secotools.com / Seco Online Store

Designation	Item number	DMM	LF	WF	LH	DCINN	KAPR°	GAMO°	LAMS°	Weight	CTWS
		mm	mm	mm	mm	mm				kg	
E08K-SCFCR06-R	75011692	8,0	125	5,0	21,0	10,0	90,0	0,0	-11,0	0,1	CC..0602..
E10M-SCFCR06-R	75011690	10,0	150	7,0	27,0	13,0	90,0	0,0	-11,0	0,2	CC..0602..
E08K-SCFCL06-R	75011691	8,0	125	5,0	21,0	10,0	90,0	0,0	-11,0	0,1	CC..0602..
E10M-SCFCL06-R	75011689	10,0	150	7,0	27,0	13,0	90,0	0,0	-11,0	0,2	CC..0602..
E12R-SCFCR09-R	75011688	12,0	200	9,0	27,0	17,0	90,0	0,0	-11,0	0,3	CC..09T3..
E16X-SCFCR09-R	75011686	16,0	230	11,0	34,0	22,0	90,0	0,0	-5,0	0,6	CC..09T3..
E12R-SCFCL09-R	75011687	12,0	200	9,0	27,0	17,0	90,0	0,0	-11,0	0,3	CC..09T3..
E16X-SCFCL09-R	75011685	16,0	230	11,0	34,0	22,0	90,0	0,0	-5,0	0,6	CC..09T3..

Spare Parts

For size	Insert key	Insert screw
E08K-...06-R	T07P-2	C02505-T07P
E10M-...06-R	T07P-2	C02506-T07P
-...09-R	T15P-2	C04008-T15P

Accessories

For size	Insert clamping torque	Replacement blade	Torque key
E08K-...06-R	0.9NM	T00-07P	T00-07P09
E10M-...06-R	0.9NM	T00-07P	T00-07P09
-...09-R	3.5NM	T00-15P	T00-15P35

SCFCR/L and SCLCR/L – Toolholders for inserts CCGT, CCGW, CCMT and CCMW – Inch

KAPR = 90,0°

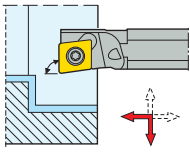

KAPR = 95,0°

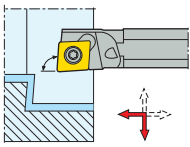

SCFCR/L

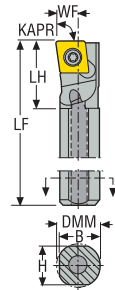

SCLCR/L

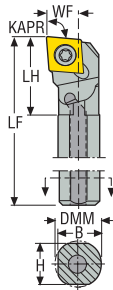

CTWS



- For inserts program, see page(s) 522, 523, 524, 525, 573, 574, 597, 599
- GAMO° = Rake angle, LAMS° = Inclination angle
- CTWS = Insert shape and size
- For holder code key, see page(s) 21-22
- Right-hand version shown
- Please check availability at www.secotools.com / Seco Online Store

Designation	Item number	DMM	H	B	LF	WF	LH	DCINN	KAPR°	GAMO°	LAMS°	Weight	CTWS
		Inch	Inch	Inch	Inch	Inch	Inch	Inch				lbs	
A06-SCFCR-2	02829665	0.375	0.315	0.345	6.000	0.252	0.402	0.508	90,0	0,0	-11,0	0.220	CC..21.5.
A08-SCFCR-3	02829670	0.500	0.425	0.463	8.000	0.315	1.551	0.630	90,0	0,0	-11,0	0.440	CC..32.5.
A06-SCLCR-2	02829667	0.375	0.315	0.345	6.000	0.250	1.025	0.472	95,0	0,0	-10,7	1.100	CC..21.5.
A08-SCLCR-2	02829673	0.500	0.425	0.463	6.000	0.312	1.550	0.571	95,0	0,0	-7,9	0.440	CC..21.5.
A10-SCLCR-2	02829681	0.375	0.531	0.578	8.000	0.406	1.250	0.728	95,0	0,0	-5,34	0.880	CC..21.5.
A06-SCLCL-2	02829666	0.375	0.315	0.345	6.000	0.250	1.025	0.472	95,0	0,0	-10,7	0.660	CC..21.5.
A08-SCLCL-2	02829671	0.500	0.425	0.463	6.000	0.312	1.550	0.571	95,0	0,0	-7,9	0.880	CC..21.5.
A10-SCLCL-2	02829679	0.625	0.531	0.578	8.000	0.406	1.250	0.728	95,0	0,0	-5,34	0.660	CC..21.5.
A08-SCLCR-3	02829674	0.500	0.425	0.481	8.000	0.315	0.551	0.630	95,0	0,0	-11,0	0.440	CC..32.5.
A10-SCLCR-3	02829682	0.625	0.531	0.578	8.000	0.406	1.250	0.812	95,0	0,0	-8,7	0.880	CC..32.5.
A12-SCLCR-3	02829690	0.750	0.650	0.732	10.000	0.500	0.752	1.000	95,0	0,0	-10,0	1.100	CC..32.5.
A16-SCLCR-3	02829697	1.000	0.902	0.951	12.000	0.640	1.906	1.250	95,0	0,0	-3,84	2.430	CC..32.5.
A08-SCLCL-3	02829672	0.500	0.425	0.463	8.000	0.315	1.551	0.630	95,0	0,0	-11,0	0.440	CC..32.5.
A10-SCLCL-3	02829680	0.625	0.531	0.578	8.000	0.406	1.250	0.812	95,0	0,0	-8,7	1.100	CC..32.5.
A12-SCLCL-3	02829689	0.750	0.650	0.732	10.000	0.500	0.752	1.000	95,0	0,0	-6,3707	1.100	CC..32.5.
A16-SCLCL-3	02829696	1.000	0.902	0.951	12.000	0.640	1.906	1.250	95,0	0,0	-3,84	1.100	CC..32.5.

Spare Parts

For size	Insert key	Insert screw
..-2	T07P-2	C02506-T07P
..-3	T15P-2	C04008-T15P

Accessories

For size	Insert clamping torque	Replacement blade	Torque key
..-2	8.0IN.LBS	T00-07P	T00-07P09
..-3	31.0IN.LBS	T00-15P	T00-15P35

General ISO Turning Holders
Steadyline®
MDT
Mini-Shaft™
Grooving
Parting-off
X4
Adapters Clamping units
Accessories and Spare parts
Workpiece materials

SCLCR/L – Toolholders for inserts CCGT, CCGW, CCGX, CCMT and CCMW – Metric

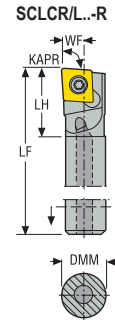
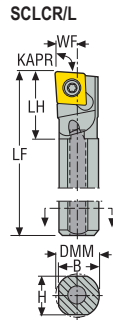
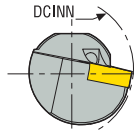

SCLCR/L..-R
KAPR = 95,0 °

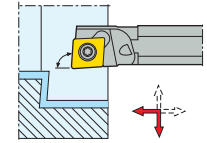



CTWS





- For inserts program, see page(s) 522, 523, 524, 525, 573, 574, 597, 599
- GAMO° = Rake angle, LAMS° = Inclination angle
- CTWS = Insert shape and size
- For holder code key, see page(s) 19-20
- Right-hand version shown
- Please check availability at www.secotools.com / Seco Online Store

Designation	Item number	DMM	H	B	LF	WF	LH	DCINN	KAPR°	GAMO°	LAMS°	Weight	CTWS
		mm	mm	mm	mm	mm	mm	mm				kg	
A08K-SCLCR06	02413804	8,0	7	8	125	5,0	12,0	10,0	95,0	0,0	-11,0	0,1	CC..0602..
A08K-SCLCR06-R	02413806	8,0	–	–	125	5,0	12,0	10,0	95,0	0,0	-11,0	0,1	CC..0602..
A10L-SCLCR06	02413808	10,0	9	10	140	7,0	18,0	13,0	95,0	0,0	-11,0	0,1	CC..0602..
A10L-SCLCR06-R	02413809	10,0	–	–	140	7,0	18,0	13,0	95,0	0,0	-11,0	0,1	CC..0602..
A12N-SCLCR06	02413810	12,0	11	12	160	9,0	20,0	17,0	95,0	0,0	-11,0	0,1	CC..0602..
A16Q-SCLCR06	02413811	16,0	15	16	180	11,0	22,0	22,0	95,0	0,0	-5,0	0,2	CC..0602..
A08K-SCLCL06	02434528	8,0	7	8	125	5,0	12,0	10,0	95,0	0,0	-11,0	0,1	CC..0602..
A08K-SCLCL06-R	02434553	8,0	–	–	125	5,0	12,0	10,0	95,0	0,0	-11,0	0,1	CC..0602..
A10L-SCLCL06	02434560	10,0	9	10	140	7,0	18,0	13,0	95,0	0,0	-11,0	0,1	CC..0602..
A10L-SCLCL06-R	02434564	10,0	–	–	140	7,0	18,0	13,0	95,0	0,0	-11,0	0,1	CC..0602..
A12N-SCLCL06	02434566	12,0	11	12	160	9,0	20,0	17,0	95,0	0,0	-11,0	0,1	CC..0602..
A16Q-SCLCL06	02434568	16,0	15	16	180	11,0	22,0	22,0	95,0	0,0	-5,0	0,2	CC..0602..
A12N-SCLCR09	02413812	12,0	11	12	160	9,0	20,0	17,0	95,0	0,0	-11,0	0,2	CC..09T3..
A12N-SCLCR09-R	02413858	12,0	–	–	160	9,0	20,0	17,0	95,0	0,0	-11,0	0,2	CC..09T3..
A16Q-SCLCR09	02413859	16,0	15	16	180	11,0	22,0	22,0	95,0	0,0	-5,0	0,2	CC..09T3..
A16Q-SCLCR09-R	02413860	16,0	–	–	180	11,0	22,0	22,0	95,0	0,0	-5,0	0,3	CC..09T3..
A20R-SCLCR09	02413861	20,0	18	19	200	13,0	32,0	25,0	95,0	0,0	-5,0	0,4	CC..09T3..
A20R-SCLCR09-R	02413862	20,0	–	–	200	13,0	32,0	25,0	95,0	0,0	-5,0	0,4	CC..09T3..
A12N-SCLCL09	02434572	12,0	11	12	160	9,0	20,0	17,0	95,0	0,0	-11,0	0,2	CC..09T3..
A12N-SCLCL09-R	02434573	12,0	–	–	160	9,0	20,0	17,0	95,0	0,0	-11,0	0,2	CC..09T3..
A16Q-SCLCL09	02434574	16,0	15	16	180	11,0	22,0	22,0	95,0	0,0	-5,0	0,2	CC..09T3..
A16Q-SCLCL09-R	02434578	16,0	–	–	180	11,0	22,0	22,0	95,0	0,0	-5,0	0,3	CC..09T3..
A20R-SCLCL09	02434581	20,0	18	19	200	13,0	32,0	25,0	95,0	0,0	-5,0	0,4	CC..09T3..
A20R-SCLCL09-R	02434584	20,0	–	–	200	13,0	32,0	25,0	95,0	0,0	-5,0	0,4	CC..09T3..

Spare Parts

For size	Insert key	Insert screw
		
A08K..	T07P-2	C02505-T07P
A10L..	T07P-2	C02505-T07P
A12N..	T07P-2	C02506-T07P
A16Q..	T07P-2	C02506-T07P
A12N..	T15P-2	C04008-T15P
A16Q..	T15P-2	C04008-T15P
A20R..	T15P-2	C04008-T15P

Accessories

For size	Insert clamping torque	Replacement blade	Torque key
			
A08K..	0.9NM	T00-07P	T00-07P09
A10L..	0.9NM	T00-07P	T00-07P09
A12N..	0.9NM	T00-07P	T00-07P09
A16Q..	0.9NM	T00-07P	T00-07P09
A12N..	3.5NM	T00-15P	T00-15P35
A16Q..	3.5NM	T00-15P	T00-15P35
A20R..	3.5NM	T00-15P	T00-15P35

General ISO Turning
Holders

Steadyline®

MDT

Mini-Shaft™

Grooving

Parting-off

X4

Adapters
Clamping units

Accessories and
Spare parts

Workpiece
materials

SCLCR/L – Toolholders for inserts CCGT, CCGW, CCMT and CCMW – Inch

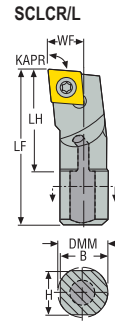

SCLCR/L
KAPR = 95,0 °

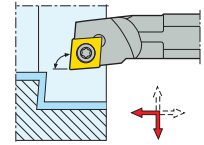





CTWS





- For inserts program, see page(s) 522, 523, 524, 525, 573, 574, 597, 599
- GAMO° = Rake angle, LAMS° = Inclination angle
- CTWS = Insert shape and size
- For holder code key, see page(s) 21-22
- E = Solid carbide shank
- Right-hand version shown
- Please check availability at www.secotools.com / Seco Online Store

Designation	Item number	DMM	H	B	LF	WF	LH	DCINN	KAPR°	GAMO°	LAMS°	Weight	CTWS
		Inch	Inch	Inch	Inch	Inch	Inch	Inch				lbs	
E06-SCLCR-2	00093165	0.375	0.315	0.350	6.000	0.250	1.063	0.500	95,0	0,0	-15,0	0.440	CC..21.5.
E08-SCLCR-2	00093167	0.500	0.425	0.470	8.000	0.313	1.063	0.625	95,0	0,0	-9,0	0.880	CC..21.5.
E10-SCLCR-2	00093179	0.625	0.531	0.587	10.000	0.406	1.339	0.812	95,0	0,0	-7,0	1.540	CC..21.5.
E06-SCLCL-2	00093166	0.375	0.315	0.350	6.000	0.250	1.063	0.500	95,0	0,0	-15,0	0.440	CC..21.5.
E08-SCLCL-2	00093178	0.500	0.425	0.470	8.000	0.313	1.063	0.625	95,0	0,0	-9,0	0.880	CC..21.5.
E10-SCLCL-2	00093181	0.625	0.531	0.587	10.000	0.406	1.339	0.812	95,0	0,0	-7,0	1.540	CC..21.5.
E12-SCLCR-3	00093183	0.750	0.650	0.707	10.000	0.500	1.457	1.000	95,0	0,0	-10,0	2.200	CC..32.5.
E12-SCLCL-3	00093184	0.750	0.650	0.707	10.000	0.500	0.984	1.000	95,0	0,0	-10,0	2.200	CC..32.5.

Spare Parts

For size	Insert key	Insert screw
...-2	 T07P-2	 C02506-T07P
...-3	 T15P-2	 C04008-T15P

Accessories

For size	Insert clamping torque	Replacement blade	Torque key
...-2	 8.0IN.LBS	 T00-07P	 T00-07P09
...-3	31.0IN.LBS	T00-15P	T00-15P35

SCLDR/L and SCFDR/L – Toolholders for inserts DCDB – Metric

SCLDR/L
KAPR = 95,0°

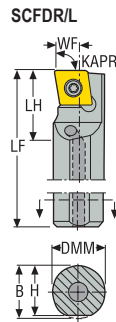
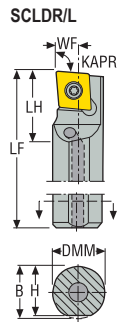
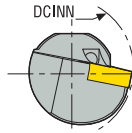
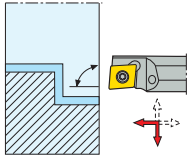

SCFDR/L
KAPR = 90,0°

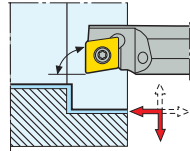

- For inserts program, see page(s) 526
- GAMO° = Rake angle, LAMS° = Inclination angle
- CTWS = Insert shape and size
- For holder code key, see page(s) 19-20
- Right-hand version shown
- Please check availability at www.secotools.com / Seco Online Store

Designation	Item number	DMM	H	B	LF	WF	LH	DCINN	KAPR°	GAMO°	LAMS°	Weight	CTWS
		mm	mm	mm	mm	mm	mm	mm				kg	
A05D-SCLDR04	00054546	5,0	5	5	60	3,0	9,7	5,5	95,0	0,0	-12,0	0,1	CD..04T0..
A06E-SCLDR04	00054660	6,0	6	6	70	3,5	10,2	6,5	95,0	0,0	-12,0	0,1	CD..04T0..
A08F-SCLDR04	00054692	8,0	8	8	80	4,5	11,2	8,5	95,0	0,0	-8,0	0,1	CD..04T0..
A05D-SCLDL04	00054545	5,0	5	5	60	3,0	9,7	5,5	95,0	0,0	-12,0	0,1	CD..04T0..
A06E-SCLDL04	00054547	6,0	6	6	70	3,5	10,2	6,5	95,0	0,0	-12,0	0,1	CD..04T0..
A08F-SCLDL04	00054679	8,0	8	8	80	4,5	11,2	8,5	95,0	0,0	-8,0	0,1	CD..04T0..
A05D-SCFDR04	00054762	5,0	5	5	60	3,0	9,7	5,5	90,0	0,0	-12,0	0,1	CD..04T0..
A06E-SCFDR04	00054765	6,0	6	6	70	3,5	10,2	6,5	90,0	0,0	-12,0	0,1	CD..04T0..
A05D-SCFDL04	00054761	5,0	5	5	60	3,0	9,7	5,5	90,0	0,0	-12,0	0,1	CD..04T0..
A06E-SCFDL04	00054763	6,0	6	6	70	3,5	10,2	6,5	90,0	0,0	-12,0	0,1	CD..04T0..

Spare Parts

For size	Insert key	Insert screw
..04	T06P-2	C11804-T06P

Accessories

For size	Insert clamping torque	Replacement blade	Torque key
..04	0.5NM	T00-06P	T00-06P05

General ISO Turning Holders
Steadyline®
MDT
Mini-Shaft™
Grooving
Parting-off
X4
Adapters Clamping units
Accessories and Spare parts
Workpiece materials

SCLDR/L – Toolholders for inserts CDCB – Inch

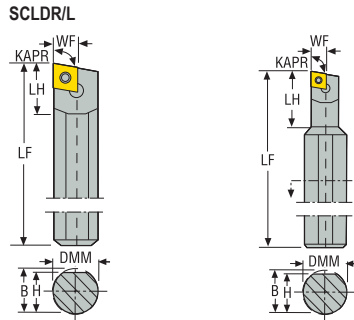

SCLDR/L
KAPR = 95,0 °

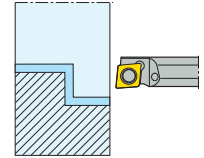

CTWS



- For inserts program, see page(s) 526
- GAMO° = Rake angle, LAMS° = Inclination angle
- CTWS = Insert shape and size
- For holder code key, see page(s) 21-22
- Bar descriptions that begin with H denotes heavy metal construction.
- Right-hand version shown
- Please check availability at www.secotools.com / Seco Online Store

Designation	Item number	DMM	H	B	LF	WF	LH	DCINN	KAPR°	GAMO°	LAMS°	Weight	CTWS
		Inch	Inch	Inch	Inch	Inch	Inch	Inch				lbs	
S03-SCLDR-1.2	00057644	0.187	0.177	0.187	2.500	0.101	0.526	0.180	95,0	0,0	-17,0	0.440	CD..1.21.2.
S04-SCLDR-1.2	00057646	0.250	0.235	0.250	3.000	0.140	–	0.265	95,0	0,0	-12,0	0.220	CD..1.21.2.
S04-SCLDL-1.2	00057647	0.250	0.235	0.250	3.000	0.141	–	0.265	95,0	0,0	-12,0	0.220	CD..1.21.2.
H03-SCLDR-1.2	00057648	0.187	0.177	0.187	4.000	0.110	0.394	0.204	95,0	0,0	-17,0	0.220	CD..1.21.2.
S0306-SCLDR-1.2	00057649	0.375	0.358	0.375	2.500	0.101	0.520	0.183	95,0	0,0	-12,0	0.220	CD..1.21.2.
S0406-SCLDR-1.2	00057650	0.375	0.358	0.358	2.500	0.152	1.250	0.277	95,0	0,0	-12,0	0.220	CD..1.21.2.
H0308-SCLDR-1.2	00057651	0.500	0.476	0.500	4.000	0.118	1.120	0.212	95,0	0,0	-17,0	0.440	CD..1.21.2.

Spare Parts

For size

Insert screw



S03
S04/H03

CS110
CS115

General ISO Turning Holders
Steadyline®
MDT
Mini-Shaft™
Grooving
Parting-off
X4
Adapters Clamping units
Accessories and Spare parts
Workpiece materials

SDQCR/L – Toolholders for inserts DCGT, DCMT and DCMW – Metric

SDQCR/L, -R
KAPR = 107,5 °

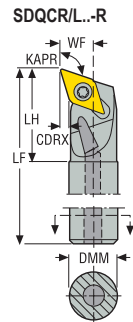
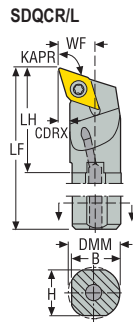
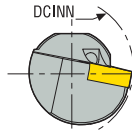
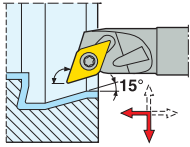

- For inserts program, see page(s) 534, 535, 536, 600
- GAMO° = Rake angle, LAMS° = Inclination angle
- CTWS = Insert shape and size
- For holder code key, see page(s) 19-20
- Right-hand version shown
- Please check availability at www.secotools.com / Seco Online Store

Designation	Item number	DMM	H	B	LF	WF	LH	CDX	DCINN	KAPR°	GAMO°	LAMS°	Weight	CTWS
		mm	mm	mm	mm	mm	mm	mm	mm				kg	
A10L-SDQCR07-R	00093833	10,0	–	–	140	7,0	18,0	1,5	13,0	107,5	0,0	-11,0	0,1	DC..0702..
A12N-SDQCR07-R	00093835	12,0	–	–	160	9,0	20,0	2,5	17,0	107,5	0,0	-11,0	0,1	DC..0702..
A16Q-SDQCR07	00093837	16,0	15	16	180	11,0	22,0	2,5	22,0	107,5	0,0	-5,0	0,3	DC..0702..
A10L-SDQCL07-R	00093834	10,0	–	–	140	7,0	18,0	1,5	13,0	107,5	0,0	-11,0	0,1	DC..0702..
A12N-SDQCL07-R	00093836	12,0	–	–	160	9,0	20,0	2,5	17,0	107,5	0,0	-11,0	0,1	DC..0702..
A16Q-SDQCL07-R	00093838	16,0	–	–	180	11,0	22,0	2,5	22,0	107,5	0,0	-5,0	0,3	DC..0702..
A20R-SDQCR11	00093839	20,0	18	19	200	13,0	32,0	2,5	25,0	107,5	0,0	-5,0	0,4	DC..11T3..
A20R-SDQCL11-R	00093840	20,0	–	–	200	13,0	32,0	2,5	25,0	107,5	0,0	-5,0	0,4	DC..11T3..
A25S-SDQCR15	00030964	25,0	23	24	250	17,0	40,0	4,0	32,0	107,5	0,0	-5,0	0,8	DC..1504..
A25S-SDQCL15	00030965	25,0	23	24	250	17,0	40,0	4,0	32,0	107,5	0,0	-5,0	0,8	DC..1504..

Spare Parts

For size	Insert key	Insert screw
A10L-...07	T07P-2	C02506-T07P
A12N-...07/R	T07P-2	C02506-T07P
A16Q-...07/R	T07P-2	C02506-T07P
...11	T15P-2	C04008-T15P
...15	T15P-2	C04512-T15P

Accessories

For size	Insert clamping torque	Replacement blade	Torque key
A10L-...07	0.9NM	T00-07P	T00-07P09
A12N-...07/R	0.9NM	T00-07P	T00-07P09
A16Q-...07/R	0.9NM	T00-07P	T00-07P09
...11	3.5NM	T00-15P	T00-15P35
...15	5.0NM	T00-15P	T00-15P50

General ISO Turning Holders
Steadyline®
MDT
Mini-Shaft™
Grooving
Parting-off
X4
Adapters Clamping units
Accessories and Spare parts
Workpiece materials

SDQCR/L – Toolholders for inserts DCGT, DCGW, DCMT and DCMW – Inch

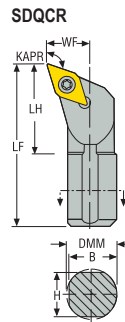

SDQCR
KAPR = 107,5°

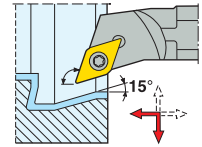

CTWS



- For inserts program, see page(s) 534, 535, 536, 578, 600
- GAMO° = Rake angle, LAMS° = Inclination angle
- CTWS = Insert shape and size
- For holder code key, see page(s) 21-22
- Right-hand version shown
- Please check availability at www.secotools.com / Seco Online Store

Designation	Item number	DMM	H	B	LF	WF	LH	DCINN	KAPR°	GAMO°	LAMS°	Weight	CTWS
		Inch	Inch	Inch	Inch	Inch	Inch	Inch				lbs	
S08-SDQCR-2	00073944	0.500	0.394	0.425	8.000	0.437	1.175	0.780	107,5	0,0	-11,0	0.660	DC..21.5.

Spare Parts

For size	Insert key	Insert screw
..-2	 T07P-2	 C02506-T07P

Accessories

For size	Insert clamping torque	Replacement blade	Torque key
..-2	 8.0IN.LBS	 T00-07P	 T00-07P09

General ISO Turning Holders
Steadyline®
MDT
Mini-Shaft™
Grooving
Parting-off
X4
Adapters Clamping units
Accessories and Spare parts
Workpiece materials

SDQNR/L and PDQNR/L – Toolholders for inserts DNMA and DNMU – Metric

SDQNR/L
KAPR = 107,5°

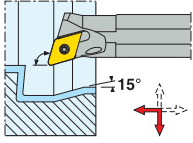

PDQNR/L
KAPR = 107,5°

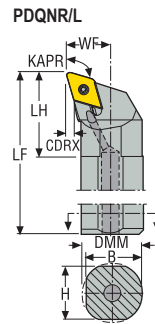
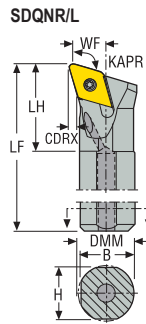
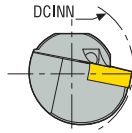
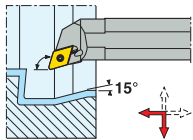

- For inserts program, see page(s) 537, 538, 539, 540, 541, 580
- GAMO° = Rake angle, LAMS° = Inclination angle
- CTWS = Insert shape and size
- For holder code key, see page(s) 19-20
- Right-hand version shown
- Please check availability at www.secotools.com / Seco Online Store

Designation	Item number	DMM	H	B	LF	WF	LH	CDX	DCINN	KAPR°	GAMO°	LAMS°	Weight	CTWS
		mm	mm	mm	mm	mm	mm	mm	mm				kg	
A16M-SDQNR11	00083822	16,0	15	16	150	11,0	20,0	4,5	20,0	107,5	-5,0	-20,0	0,2	DNMU1104..
A20Q-SDQNR11	75077819	20,0	18	19	180	13,0	30,0	4,7	25,0	107,5	-5,0	-18,0	0,3	DNMU1104..
A16M-SDQNL11	00083824	16,0	15	16	150	11,0	20,0	4,5	20,0	107,5	-5,0	-20,0	0,2	DNMU1104..
A20Q-SDQNL11	75077820	20,0	18	19	180	13,0	30,0	4,7	25,0	107,5	-5,0	-18,0	0,3	DNMU1104..
A25R-PDQNR11	75077821	25,0	23	24	200	17,0	35,0	4,7	32,0	107,5	-5,0	-16,0	0,7	DN..1104..
A32S-PDQNR11	75077823	32,0	30	31	250	22,0	32,0	4,7	40,0	107,5	-5,0	-14,0	1,3	DN..1104..
A25R-PDQNL11	75077822	25,0	23	24	200	17,0	35,0	4,7	32,0	107,5	-5,0	-16,0	0,7	DN..1104..
A32S-PDQNL11	75079497	32,0	30	31	250	22,0	32,0	4,7	40,0	107,5	-5,0	-14,0	1,3	DN..1104..

Spare Parts

For size	Insert key	Insert pin	Insert screw	Insert shim	Shim screw
A16M-...11	T09P-2	-	C03511-T09P	-	-
A20Q-...11	T09P-2	-	C03511-T09P	DAI110212	CA3507
A25R-...11	T09P-2	PL1403-T09P	-	DAE110312	-
A32S-...11	T09P-2	PL1403-T09P	-	DAE110312	-

Accessories

For size	Insert clamping torque	Replacement blade	Shim key	Torque key
A16M-...11	2.0NM	T00-09P	-	T00-09P20
A20Q-...11	2.0NM	T00-09P	9/64SMS875	T00-09P20
A25R-...11	-	-	-	-
A32S-...11	-	-	-	-

General ISO Turning Holders
Steadyline®
MDT
Mini-Shaft™
Grooving
Parting-off
X4
Adapters and Clamping units
Accessories and Spare parts
Workpiece materials

SDQNR/L and PDQNR/L – Toolholders for inserts DNMA, DNMG, DNMP and DNMU – Inch

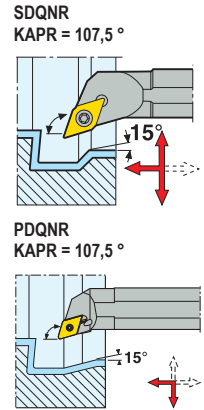
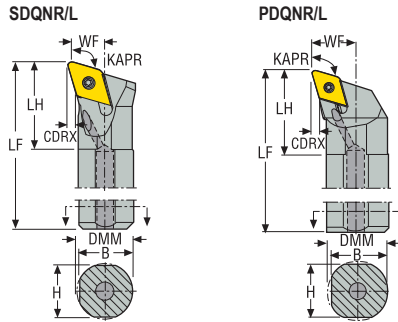

CTWS



- For inserts program, see page(s) 537, 538, 539, 540, 541, 580
- GAMO° = Rake angle, LAMS° = Inclination angle
- CTWS = Insert shape and size
- For holder code key, see page(s) 21-22
- Right-hand version shown
- Please check availability at www.secotools.com / Seco Online Store

Designation	Item number	DMM	H	B	LF	WF	LH	DCINN	KAPR°	GAMO°	LAMS°	Weight	CTWS
		Inch	Inch	Inch	Inch	Inch	Inch	Inch				lbs	
A12-SDQNR-3	00015216	0.750	0.709	0.728	10.000	0.562	1.839	0.980	107,5	-6,0	-14,0	1.540	DN..33.
A16-PDQNR-3	00015218	1.000	0.866	0.933	12.000	0.750	1.921	1.299	107,5	-5,0	-12,0	2.430	DN..33.

Spare Parts

For size	Insert key	Insert pin	Insert screw	Insert shim	Key	Shim screw
12-3	T09P-2	-	C03511-T09P	DSN-323	-	CA3507
16-3	-	PL1403-T09P	-	DSN-323	T09P-2	-

Accessories

For size	Insert clamping torque	Key	Replacement blade	Torque key
12-3	17.7IN.LBS	3.5SMS795	T00-09P	T00-09P20
16-3	-	-	-	-

General ISO Turning Holders
Steadyline®
MDT
Mini-Shaft™
Grooving
Parting-off
X4
Adapters Clamping units
Accessories and Spare parts
Workpiece materials

SDUCR/L – Toolholders for inserts DCGT, DCMT, DCMW and DCMX – Metric

SDUCR/L, -R
KAPR = 93,0°

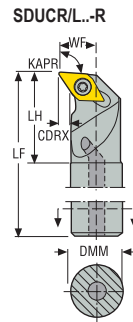
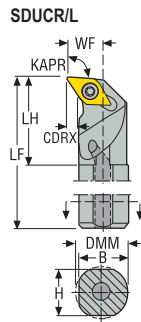
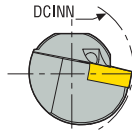
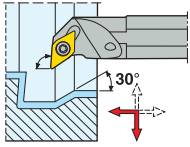



- For inserts program, see page(s) 534, 535, 536, 600
- GAMO° = Rake angle, LAMS° = Inclination angle
- CTWS = Insert shape and size
- For holder code key, see page(s) 19-20
- Right-hand version shown
- Please check availability at www.secotools.com / Seco Online Store

Designation	Item number	DMM	H	B	LF	WF	LH	CDX	DCINN	KAPR°	GAMO°	LAMS°	Weight	CTWS
		mm	mm	mm	mm	mm	mm	mm	mm				kg	
A12N-SDUCR07	02516530	12,0	11	12	160	9,0	20,0	0,9	17,0	93,0	0,0	-11,0	0,2	DC..0702..
A12N-SDUCR07-R	00093821	12,0	-	-	160	9,0	20,0	0,9	17,0	93,0	0,0	-11,0	0,2	DC..0702..
A16Q-SDUCR07	75066214	16,0	15	16	180	11,0	22,0	1,0	22,0	93,0	0,0	-5,0	0,3	DC..0702..
A16Q-SDUCR07-R	00093825	16,0	-	-	180	11,0	22,0	1,0	22,0	93,0	0,0	-5,0	0,3	DC..0702..
A12N-SDUCL07	75066213	12,0	11	12	160	9,0	20,0	0,9	17,0	93,0	0,0	-11,0	0,2	DC..0702..
A12N-SDUCL07-R	00093822	12,0	-	-	160	9,0	20,0	0,9	17,0	93,0	0,0	-11,0	0,2	DC..0702..
A16Q-SDUCL07	75066215	16,0	15	16	180	11,0	22,0	1,0	22,0	93,0	0,0	-5,0	0,3	DC..0702..
A16Q-SDUCL07-R	00734206	16,0	-	-	180	11,0	22,0	1,0	22,0	93,0	0,0	-5,0	0,3	DC..0702..
A20R-SDUCR11	00734209	20,0	18	19	200	13,0	30,0	1,7	25,0	93,0	0,0	-5,0	0,4	DC..11T3..
A20R-SDUCR11-R	00093829	20,0	-	-	200	13,0	30,0	1,7	25,0	93,0	0,0	-5,0	0,4	DC..11T3..
A25S-SDUCR11	02516541	25,0	23	24	250	17,0	40,0	1,9	32,0	93,0	0,0	-5,0	0,8	DC..11T3..
A25S-SDUCR11-R	02516599	25,0	-	-	250	17,0	40,0	1,9	32,0	93,0	0,0	-5,0	0,9	DC..11T3..
A20R-SDUCL11	02516546	20,0	18	19	200	13,0	30,0	1,7	25,0	93,0	0,0	-5,0	0,4	DC..11T3..
A20R-SDUCL11-R	00093830	20,0	-	-	200	13,0	30,0	1,7	25,0	93,0	0,0	-5,0	0,4	DC..11T3..
A25S-SDUCL11	02516549	25,0	23	24	250	17,0	40,0	1,9	32,0	93,0	0,0	-5,0	0,8	DC..11T3..
A25S-SDUCL11-R	02516600	25,0	-	-	250	17,0	40,0	1,9	32,0	93,0	0,0	-5,0	0,9	DC..11T3..
A32T-SDUCR15	00030967	32,0	30	31	300	22,0	50,0	2,3	40,0	93,0	0,0	-5,0	1,6	DC..1504..
A32T-SDUCL15	00030968	32,0	30	31	300	22,0	50,0	2,3	40,0	93,0	0,0	-5,0	1,6	DC..1504..

Spare Parts

For size	Insert key	Insert screw
A12N-...07/R	 T07P-2	 C02506-T07P
A16Q-...07/R	T07P-2	C02506-T07P
A20R-...11/R	 T15P-2	 C04008-T15P
A25S-...11/R	T15P-2	C04008-T15P
A32T-...15/R	T15P-2	C04512-T15P

Accessories

For size	Insert clamping torque	Replacement blade	Torque key
			
A12N-...07/R	0.9NM	T00-07P	T00-07P09
A16Q-...07/R	0.9NM	T00-07P	T00-07P09
A20R-...11/R	3.5NM	T00-15P	T00-15P35
A25S-...11/R	3.5NM	T00-15P	T00-15P35
A32T-...15/R	5.0NM	T00-15P	T00-15P50

General ISO Turning
Holders

Steadyline®

MDT

Mini-Shaft™

Grooving

Parting-off

X4

Adapters
Clamping units

Accessories and
Spare parts

Workpiece
materials

SDUNR/L – Toolholders for inserts DNMA, DNMU and DNMX – Metric

SDUNR/L
KAPR = 93,0°

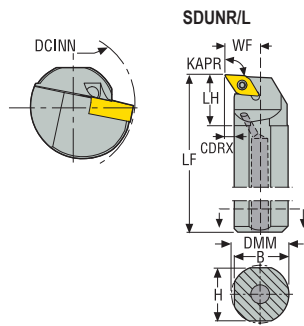
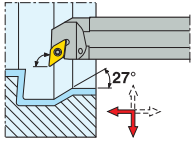

- For inserts program, see page(s) 537, 538, 539, 540, 541, 580
- GAMO° = Rake angle, LAMS° = Inclination angle
- CTWS = Insert shape and size
- For holder code key, see page(s) 19-20
- Right-hand version shown
- Please check availability at www.secotools.com / Seco Online Store

Designation	Item number	DMM	H	B	LF	WF	LH	CDX	DCINN	KAPR°	GAMO°	LAMS°	Weight	CTWS
		mm	mm	mm	mm	mm	mm	mm	mm				kg	
A16M-SDUNR11	00083816	16,0	15	16	150	11,0	20,0	1,9	20,0	93,0	-5,0	-17,0	0,3	DN..1104..
A20Q-SDUNR11	75066111	20,0	18	19	180	13,0	30,0	2,3	25,0	93,0	-5,0	-14,0	0,3	DN..1104..
A16M-SDUNL11	00083817	16,0	15	16	150	11,0	20,0	1,9	20,0	93,0	-5,0	-17,0	0,3	DN..1104..
A20Q-SDUNL11	75066112	20,0	18	19	180	13,0	30,0	2,3	25,0	93,0	-5,0	-14,0	0,3	DN..1104..

Spare Parts

For size	Insert key	Insert screw	Insert shim	Shim screw
A16M-11	T09P-2	C03511-T09P	-	-
A20Q-11	T09P-2	C03511-T09P	DAI110212	CA3507

Accessories

For size	Insert clamping torque	Replacement blade	Shim key	Torque key
A16M-11	2.0NM	T00-09P	-	T00-09P20
A20Q-11	2.0NM	T00-09P	9/64SMS875	T00-09P20

General ISO Turning Holders
Steadyline®
MDT
Mini-Shaft™
Grooving
Parting-off
X4
Adapters Clamping units
Accessories and Spare parts
Workpiece materials



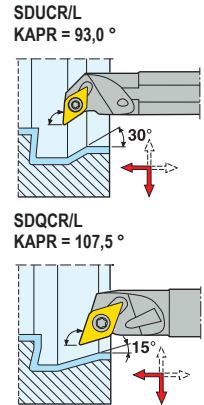
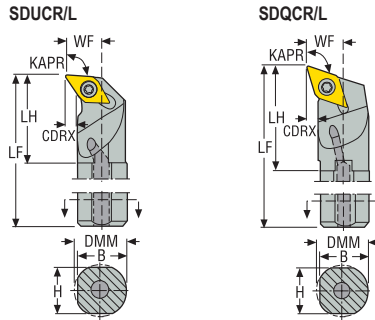

SDUCR/L and SDQCR/L – Toolholders for inserts DCGT, DCGW, DCMT and DCMW – Inch









- For inserts program, see page(s) 534, 535, 536, 578, 600
- GAMO° = Rake angle, LAMS° = Inclination angle
- CTWS = Insert shape and size
- For holder code key, see page(s) 21-22
- Right-hand version shown
- Please check availability at www.secotools.com / Seco Online Store

Designation	Item number	DMM	H	B	LF	WF	LH	DCINN	KAPR°	GAMO°	LAMS°	Weight	CTWS
		Inch	Inch	Inch	Inch	Inch	Inch	Inch				lbs	
A08-SDUCR-2	02829675	0.500	0.425	0.463	6.000	0.438	1.175	0.780	93,0	0,0	-5,01	0.660	DC..21.5.
A10-SDUCR-2	02829685	0.625	0.531	0.578	8.000	0.500	1.250	1.000	93,0	0,0	-3,7	0.440	DC..21.5.
A10-SDUCL-2	02829684	0.625	0.531	0.578	8.000	0.500	1.250	0.500	93,0	0,0	-3,7	1.100	DC..21.5.
A12-SDUCR-3	02829693	0.750	0.902	0.957	12.000	0.750	0.906	1.125	93,0	0,0	-4,0	2.650	DC..32.5.
A16-SDUCR-3	02829700	1.000	0.902	0.957	12.000	0.750	1.906	1.500	93,0	0,0	-3,16	1.100	DC..32.5.
A12-SDUCL-3	02829692	0.750	0.650	0.707	10.000	0.625	1.750	1.125	93,0	0,0	-5,07	1.980	DC..32.5.
A16-SDUCL-3	02829699	1.000	0.902	0.957	12.000	0.750	1.906	1.500	93,0	0,0	-3,16	1.980	DC..32.5.
A10-SDQCR-2	02829683	0.625	0.535	0.578	10.000	0.500	0.625	0.840	107,5	0,0	-5,0	1.100	DC..21.5.
A12-SDQCR-3	02829691	0.750	0.708	0.729	10.000	0.562	0.773	1.125	107,5	0,0	-5,95	0.660	DC..32.5.
A16-SDQCR-3	02829698	1.000	0.858	0.929	12.000	0.750	0.906	1.500	107,5	0,0	-3,27	2.200	DC..32.5.

Spare Parts

For size	Insert key	Insert screw
...2	 T07P-2	 C02506-T07P
...3	 T15P-2	 C04008-T15P

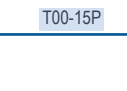
Accessories

For size	Insert clamping torque	Replacement blade	Torque key
...2	 8.0IN.LBS	 T00-07P	 T00-07P09
...3	 31.0IN.LBS	 T00-15P	 T00-15P35

SDUNR/L – Toolholders for inserts DNMU – Inch

SDUNR
KAPR = 93,0°

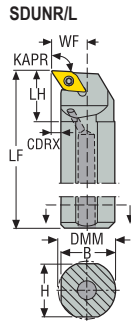
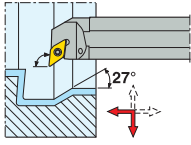

CTWS



- For inserts program, see page(s) 537, 538, 539, 540, 541
- GAMO° = Rake angle, LAMS° = Inclination angle
- CTWS = Insert shape and size
- For holder code key, see page(s) 21-22
- Right-hand version shown
- Please check availability at www.secotools.com / Seco Online Store

Designation	Item number	DMM	H	B	LF	WF	LH	DCINN	KAPR°	GAMO°	LAMS°	Weight	CTWS
		Inch	Inch	Inch	Inch	Inch	Inch	Inch				lbs	
A10-SDUNR-3	00014820	0.625	0.532	0.602	10.000	0.500	1.598	0.850	93,0	-5,0	-14,0	1.100	DN..33.
A12-SDUNR-3	00014822	0.750	0.709	0.728	10.000	0.562	1.799	0.980	93,0	-5,0	-14,0	1.540	DN..33.

Spare Parts

For size	Insert key	Insert screw	Insert shim	Shim screw
..10-3	 T09P-2	 C03511-T09P	 -	 -
..12-3	 T09P-2	 C03511-T09P	 DSN-323	 CA3507

Accessories

For size	Insert clamping torque	Replacement blade	Shim key	Torque key
..10-3	 17.7IN.LBS	 T00-09P	 -	 T00-09P20
..12-3	 17.7IN.LBS	 T00-09P	 3.5SMS795	 T00-09P20

General ISO Turning
Holders

Steadyline®

MDT

Mini-Shaft™

Grooving

Parting-off

X4

Adapters
Clamping units

Accessories and
Spare parts

Workpiece
materials

SDYNR/L and PDYNR/L – Toolholders for inserts DNMA and DNMU – Metric

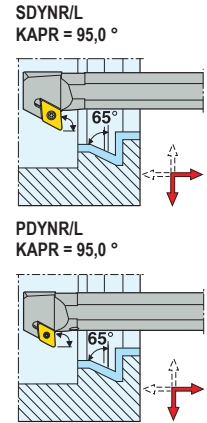
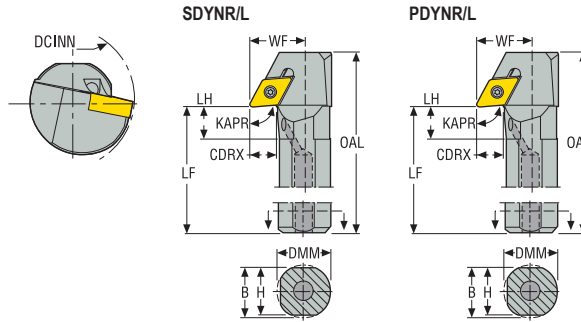

CTWS



- For inserts program, see page(s) 537, 538, 539, 540, 541, 580
- GAMO° = Rake angle, LAMS° = Inclination angle
- CTWS = Insert shape and size
- For holder code key, see page(s) 19-20
- Right-hand version shown
- Please check availability at www.secotools.com / Seco Online Store

Designation	Item number	DMM	H	B	OAL	LF	WF	LH	CDRX	DCINN	KAPR°	GAMO°	LAMS°	Weight	CTWS
		mm	mm	mm	mm	mm	mm	mm	mm	mm				kg	
A20Q-SDYNR11	75079498	20,0	18	19	200	180	20,0	15,0	10,9	40,0	95,0	-5,0	-14,0	0,4	DNMU1104..
A20Q-SDYNL11	75079499	20,0	18	19	200	180	20,0	15,0	10,9	40,0	95,0	-5,0	-14,0	0,4	DNMU1104..
A25R-PDYNR11	75079500	25,0	23	24	220	200	22,5	13,0	10,9	45,0	95,0	-5,0	-13,0	0,8	DN..1104..
A32S-PDYNR11	75079502	32,0	30	31	270	250	25,5	23,0	11,1	51,0	95,0	-5,0	-11,0	1,5	DN..1104..
A25R-PDYNL11	75079501	25,0	23	24	220	200	22,5	13,0	10,9	45,0	95,0	-5,0	-13,0	0,8	DN..1104..
A32S-PDYNL11	75079503	32,0	30	31	270	250	25,5	23,0	11,1	51,0	95,0	-5,0	-11,0	1,5	DN..1104..

Spare Parts

For size	Insert key	Insert pin	Insert screw	Insert shim	Shim screw
A20Q-...11	T09P-2	-	C03511-T09P	DAI110212	CA3507
A25R-...11	T09P-2	PL1403-T09P	-	DAE110312	-
A32S-...11	T09P-2	PL1403-T09P	-	DAE110312	-

Accessories

For size	Insert clamping torque	Replacement blade	Shim key	Torque key
A20Q-...11	2.0NM	T00-09P	9/64SMS875	T00-09P20
A25R-...11	-	-	-	-
A32S-...11	-	-	-	-

STFCR/L – Toolholders for inserts TCGT, TCMT and TCMW – Metric

STFCR/L
KAPR = 90,0°

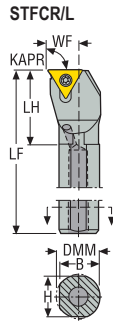
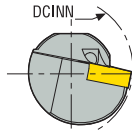
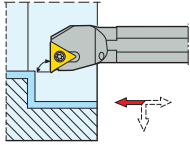

- For inserts program, see page(s) 555, 556, 601
- GAMO° = Rake angle, LAMS° = Inclination angle
- CTWS = Insert shape and size
- For holder code key, see page(s) 19-20
- Right-hand version shown
- Please check availability at www.secotools.com / Seco Online Store

Designation	Item number	DMM	H	B	LF	WF	LH	DCINN	KAPR°	GAMO°	LAMS°	Weight	CTWS
		mm	mm	mm	mm	mm	mm	mm				kg	
A12M-STFCR11	00093843	12,0	11	12	150	9,0	21,0	16,0	90,0	0,0	-10,0	0,2	TC..1102..
A16R-STFCR11	00093845	16,0	15	15	200	11,0	25,0	20,0	90,0	0,0	-6,0	0,3	TC..1102..
A20S-STFCR11	00093847	20,0	18	19	250	13,0	25,0	25,0	90,0	0,0	-3,0	0,5	TC..1102..
A12M-STFCL11	00093844	12,0	11	12	150	9,0	21,0	16,0	90,0	0,0	-10,0	0,2	TC..1102..
A16R-STFCL11	00093846	16,0	15	15	200	11,0	25,0	20,0	90,0	0,0	-6,0	0,3	TC..1102..
A20S-STFCL11	00093848	20,0	18	19	250	13,0	25,0	25,0	90,0	0,0	-3,0	0,5	TC..1102..
A25R-STFCR16	00093857	25,0	23	24	200	17,0	36,0	32,0	90,0	0,0	-6,0	0,7	TC..16T3..
A32S-STFCR16	00093859	32,0	30	31	250	22,0	42,0	40,0	90,0	0,0	-10,0	1,3	TC..16T3..
A40T-STFCR16	00093861	40,0	37	39	300	27,0	50,0	50,0	90,0	0,0	-8,0	2,6	TC..16T3..
A25R-STFCL16	00093858	25,0	23	24	200	17,0	36,0	32,0	90,0	0,0	-6,0	0,7	TC..16T3..
A32S-STFCL16	00093860	32,0	30	31	250	22,0	42,0	40,0	90,0	0,0	-10,0	1,3	TC..16T3..
A40T-STFCL16	00093862	40,0	37	39	300	27,0	50,0	50,0	90,0	0,0	-8,0	2,6	TC..16T3..

Spare Parts

For size	Insert key	Insert screw	Insert shim	Shim screw
A12M...11	T07P-2	C02506-T07P	-	-
A16R...11	T07P-2	C02506-T07P	-	-
A20S...11	T07P-2	C02506-T07P	-	-
A25R...16	T15P-2	C03509-T15P	-	-
A32S...16	T15P-2	C03509-T15P	STN160312	CA3510
A40T...16	T15P-2	C03509-T15P	STN160312	CA3510

General ISO Turning
Holders

Steadyline®

MDT

Mini-Shaft™

Grooving

Parting-off



X4

Adapters
Clamping units

Accessories and
Spare parts

Workpiece
materials

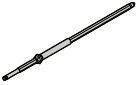
Accessories

For size	Insert clamping torque 	Replacement blade 	Shim key 	Torque key 
A12M-...11	0.9NM	T00-07P	-	T00-07P09
A16R-...11	0.9NM	T00-07P	-	T00-07P09
A20S-...11	0.9NM	T00-07P	-	T00-07P09
A25R-...16	3.0NM	T00-15P	-	T00-15P30
A32S-...16	3.0NM	T00-15P	9/64SMS875	T00-15P30
A40T-...16	3.0NM	T00-15P	9/64SMS875	T00-15P30

General ISO Turning
Holders

Steadyline®

MDT

Mini-Shaft™

Grooving

Parting-off

X4

Adapters
Clamping units

Accessories and
Spare parts

Workpiece
materials

STFCR/L and STUCR/L – Toolholders for inserts TCMT and TCMW – Inch

STFCR/L
KAPR = 90,0°

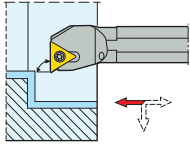

STUCR/L
KAPR = 93,0°

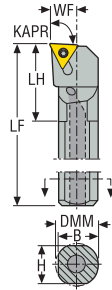
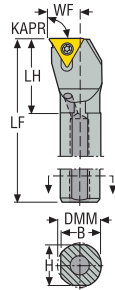
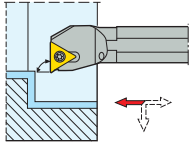





CTWS









- For inserts program, see page(s) 555, 556, 601
- GAMO° = Rake angle, LAMS° = Inclination angle
- CTWS = Insert shape and size
- For holder code key, see page(s) 21-22
- Right-hand version shown
- Please check availability at www.secotools.com / Seco Online Store

Designation	Item number	DMM	H	B	LF	WF	LH	DCINN	KAPR°	GAMO°	LAMS°	Weight	CTWS
		Inch	Inch	Inch	Inch	Inch	Inch	Inch				lbs	
A06-STFCR-2	02829668	0.375	0.315	0.345	6.000	0.250	1.400	0.512	90,0	0,0	-10,07	0.440	TC..21.5.
A08-STFCR-2	02829676	0.500	0.425	0.463	6.000	0.312	1.550	0.625	90,0	0,0	-7,21	0.660	TC..21.5.
A10-STFCR-2	02829686	0.625	0.531	0.578	8.000	0.406	1.250	0.812	90,0	0,0	-4,7	1.100	TC..21.5.
A12-STFCR-2	02829694	0.750	0.650	0.707	10.000	0.500	0.750	1.000	90,0	0,0	-3,16	1.100	TC..21.5.
A06-STUCR-2	02829669	0.375	0.315	0.345	6.000	0.250	1.400	0.500	93,0	0,0	-11,0	0.220	TC..21.5.
A08-STUCR-2	02829678	0.500	0.425	0.463	8.000	0.313	1.550	0.625	93,0	0,0	-9,0	0.440	TC..21.5.
A10-STUCR-2	02829688	0.625	0.531	0.578	10.000	0.406	1.250	0.812	93,0	0,0	-7,0	0.880	TC..21.5.
A08-STUCL-2	02829677	0.500	0.425	0.463	8.000	0.313	1.550	0.630	93,0	0,0	-9,0	0.440	TC..21.5.
A10-STUCL-2	02829687	0.625	0.531	0.578	10.000	0.406	1.250	0.812	93,0	0,0	-7,0	0.880	TC..21.5.
A12-STUCR-3	02829695	0.750	0.708	0.729	10.000	0.500	0.750	1.000	93,0	0,0	-6,0	1.100	TC..32.5.
A16-STUCR-3	02829701	1.000	0.858	0.929	12.000	0.640	0.906	1.280	93,0	0,0	-4,0	2.200	TC..32.5.

Spare Parts

For size	Insert key	Insert screw
..-2	 T07P-2	 C02506-T07P
..-3	 T15P-2	 C04008-T15P

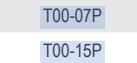
Accessories

For size	Insert clamping torque	Replacement blade	Torque key
..-2	 8.0IN.LBS	 T00-07P	 T00-07P09
..-3	 31.0IN.LBS	 T00-15P	 T00-15P35

General ISO Turning Holders
Steadyline®
MDT
Mini-Shaft™
Grooving
Parting-off
X4
Adapters Clamping units
Accessories and Spare parts
Workpiece materials

STFCR/L – Toolholders for inserts TCGT, TCGW, TCMT and TCMW – Inch

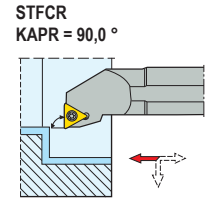
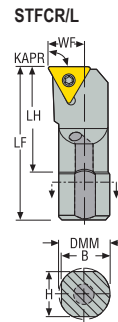

CTWS



- For inserts program, see page(s) 555, 556, 589, 601
- GAMO° = Rake angle, LAMS° = Inclination angle
- CTWS = Insert shape and size
- For holder code key, see page(s) 21-22
- E = Solid carbide shank
- Right-hand version shown
- Please check availability at www.secotools.com / Seco Online Store

Designation	Item number	DMM	H	B	LF	WF	LH	DCINN	KAPR°	GAMO°	LAMS°	Weight	CTWS
		Inch	Inch	Inch	Inch	Inch	Inch	Inch				lbs	
E06-STFCR-2	00093116	0.375	0.315	0.350	6.000	0.250	1.063	0.500	90,0	0,0	-15,0	0.440	TC..21.5.
E08-STFCR-2	00093118	0.500	0.425	0.470	8.000	0.313	1.063	0.625	90,0	0,0	-9,0	0.880	TC..21.5.

Spare Parts

For size	Insert key	Insert screw
..-2	 T07P-2	 C02506-T07P

Accessories

For size	Insert clamping torque	Replacement blade	Torque key
..-2	 8.0IN.LBS	 T00-07P	 T00-07P09

General ISO Turning Holders
Steadyline®
MDT
Mini-Shaft™
Grooving
Parting-off
X4
Adapters Clamping units
Accessories and Spare parts
Workpiece materials

STLDR/L and STFDR/L – Toolholders for inserts TDAB and TDCH – Metric

STLDR/L
KAPR = 95,0°

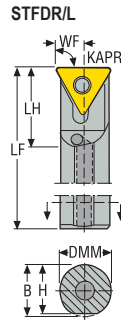
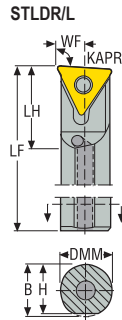
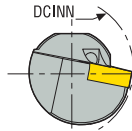
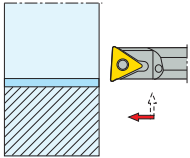

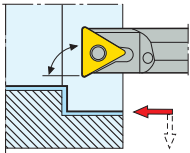

STFDR/L
KAPR = 90,0°





- For inserts program, see page(s) 557
- GAMO° = Rake angle, LAMS° = Inclination angle
- CTWS = Insert shape and size
- For holder code key, see page(s) 19-20
- Right-hand version shown
- Please check availability at www.secotools.com / Seco Online Store

Designation	Item number	DMM	H	B	LF	WF	LH	DCINN	KAPR°	GAMO°	LAMS°	Weight	CTWS
		mm	mm	mm	mm	mm	mm	mm				kg	
A05D-STLDR06	00054775	5,0	5	5	60	3,0	9,7	6,8	95,0	0,0	-12,0	0,1	TD..06..
A06E-STLDR06	00054777	6,0	6	6	70	3,5	10,2	7,2	95,0	0,0	-12,0	0,1	TD..06..
A08F-STLDR06	00054780	8,0	8	8	80	4,5	11,2	8,8	95,0	0,0	-8,0	0,1	TD..06..
A05D-STLDR06	00054768	5,0	5	5	60	3,0	9,7	6,8	95,0	0,0	-12,0	0,1	TD..06..
A06E-STLDR06	00054776	6,0	6	6	70	3,5	10,2	7,2	95,0	0,0	-12,0	0,1	TD..06..
A08F-STLDR06	00054778	8,0	8	8	80	4,5	11,2	8,8	95,0	0,0	-8,0	0,1	TD..06..
A05D-STFDR06	00054839	5,0	5	5	60	3,0	9,7	6,8	90,0	0,0	-12,0	0,1	TD..06..
A06E-STFDR06	00054841	6,0	6	6	70	3,5	10,2	7,2	90,0	0,0	-12,0	0,1	TD..06..
A08F-STFDR06	00054843	8,0	8	8	80	4,5	11,2	8,8	90,0	0,0	-8,0	0,1	TD..06..
A05D-STFDR06	00054810	5,0	5	5	60	3,0	9,7	6,8	90,0	0,0	-12,0	0,1	TD..06..
A06E-STFDR06	00054840	6,0	6	6	70	3,5	10,2	7,2	90,0	0,0	-12,0	0,1	TD..06..
A08F-STFDR06	00054842	8,0	8	8	80	4,5	11,2	8,8	90,0	0,0	-8,0	0,1	TD..06..

Spare Parts

For size	Insert key	Insert screw
...06	 T06P-2	 C82204-T06P

Accessories

For size	Insert clamping torque	Replacement blade	Torque key
...06	 0.5NM	 T00-06P	 T00-06P05

STLDR/L and STFDR/L – Toolholders for inserts TDAB and TDCH – Inch

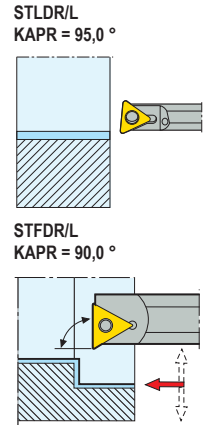
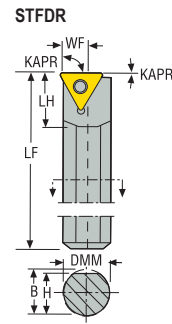
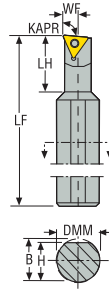
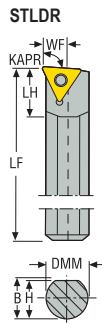

- For inserts program, see page(s) 557
- GAMO° = Rake angle, LAMS° = Inclination angle
- CTWS = Insert shape and size
- For holder code key, see page(s) 21-22
- Bar descriptions that begin with H denotes heavy metal construction.
- Right-hand version shown
- Please check availability at www.secotools.com / Seco Online Store

Designation	Item number	DMM	H	B	LF	WF	LH	DCINN	KAPR°	GAMO°	LAMS°	Weight	CTWS
		Inch	Inch	Inch	Inch	Inch	Inch	Inch				lbs	
S04-STLDR-1.2	00057658	0.250	0.235	0.250	4.000	0.165	0.394	0.290	95,0	0,0	-12,0	0.220	TD..1.21.5.
S05-STLDR-1.2	00057659	0.313	0.295	0.295	4.000	0.194	–	0.350	95,0	0,0	-12,0	0.440	TD..1.21.5.
H04STLDR-1.2	00057661	0.250	0.235	0.250	4.000	0.165	0.394	0.290	95,0	0,0	-12,0	0.440	TD..1.21.5.
H05STLDR-1.2	00057662	0.313	0.295	0.313	6.000	0.194	0.394	0.350	95,0	0,0	-8,0	0.220	TD..1.21.5.
S0408-STLDR-1.2	00057664	0.500	0.480	0.480	3.250	0.175	1.250	0.300	95,0	0,0	-12,0	0.220	TD..1.21.5.
H0408STLDR-1.2	00057666	0.500	0.480	0.500	3.250	0.175	1.250	0.300	95,0	0,0	-12,0	0.440	TD..1.21.5.
S05-STFDR-1.2	00057667	0.313	0.295	0.295	4.000	0.194	–	0.350	90,0	0,0	-12,0	0.220	TD..1.21.5.

Spare Parts

For size

Insert screw



...-1.2

CS120

General ISO Turning Holders
Steadyline®
MDT
Mini-Shaft™
Grooving
Parting-off
X4
Adapters Clamping units
Accessories and Spare parts
Workpiece materials

SVQBR/L and SVUBR/L – Toolholders for inserts VBGT, VBGW, VBMT, VBMT and VCGT – Metric

SVQBR/L
KAPR = 107,5 °

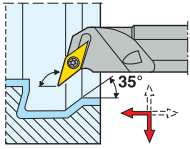

SVUBR/L
KAPR = 93,0 °

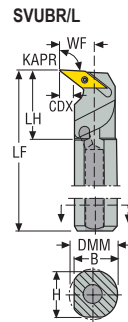
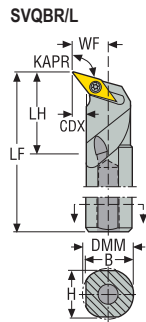
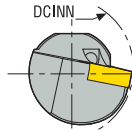
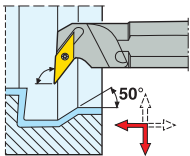

- For inserts program, see page(s) 563, 564, 564, 594, 602
- GAMO° = Rake angle, LAMS° = Inclination angle
- CTWS = Insert shape and size
- For holder code key, see page(s) 19-20
- Right-hand version shown
- Please check availability at www.secotools.com / Seco Online Store



Designation	Item number	DMM	H	B	LF	WF	LH	CDX	DCINN	KAPR°	GAMO°	LAMS°	Weight	CTWS
		mm	mm	mm	mm	mm	mm	mm	mm				kg	
A16R-SVQBR11	00093873	16,0	15	15	200	13,0	25,0	4,5	22,0	107,5	0,0	-7,0	0,3	VB..1102..
A20S-SVQBR11	00093875	20,0	18	19	250	15,0	25,0	4,5	27,0	107,5	0,0	-6,0	0,5	VB..1102..
A25T-SVQBR11	00093877	25,0	23	23	300	18,0	35,0	5,0	33,0	107,5	0,0	-4,0	1,0	VB..1102..
A16R-SVQBL11	00093874	16,0	15	15	200	13,0	25,0	4,5	22,0	107,5	0,0	-7,0	0,3	VB..1102..
A20S-SVQBL11	00093876	20,0	18	19	250	15,0	25,0	4,5	27,0	107,5	0,0	-6,0	0,5	VB..1102..
A25T-SVQBL11	00093878	25,0	23	23	300	18,0	35,0	5,0	33,0	107,5	0,0	-4,0	1,0	VB..1102..
A25S-SVQBR16	00030970	25,0	23	24	250	17,0	65,0	4,0	32,0	107,5	0,0	-8,0	0,8	VB..VC..1604..
A32T-SVQBR16	00030971	32,0	30	31	300	22,0	70,0	5,5	40,0	107,5	0,0	-8,0	1,6	VB..VC..1604..
A40U-SVQBR16	00030974	40,0	37	39	350	27,0	80,0	6,5	50,0	107,5	0,0	-8,0	2,9	VB..VC..1604..
A25S-SVQBL16	00030977	25,0	23	24	250	17,0	65,0	4,0	32,0	107,5	0,0	-8,0	0,8	VB..VC..1604..
A32T-SVQBL16	00030979	32,0	30	31	300	22,0	70,0	5,5	40,0	107,5	0,0	-8,0	1,5	VB..VC..1604..
A40U-SVQBL16	00030983	40,0	37	39	350	27,0	80,0	6,5	50,0	107,5	0,0	-8,0	2,9	VB..VC..1604..
A16R-SVUBR11	00093867	16,0	15	15	200	13,0	25,0	4,5	22,0	93,0	0,0	-7,0	0,3	VB..1102..
A20S-SVUBR11	00093869	20,0	18	19	250	15,0	25,0	4,5	27,0	93,0	0,0	-5,0	0,5	VB..1102..
A25T-SVUBR11	00093871	25,0	23	23	300	18,0	35,0	5,0	33,0	93,0	0,0	-3,0	1,0	VB..1102..
A16R-SVUBL11	00093868	16,0	15	15	200	13,0	25,0	4,5	22,0	93,0	0,0	-7,0	0,3	VB..1102..
A20S-SVUBL11	00093870	20,0	18	19	250	15,0	25,0	4,5	27,0	93,0	0,0	-5,0	0,5	VB..1102..
A25T-SVUBL11	00093872	25,0	23	23	300	18,0	35,0	5,0	33,0	93,0	0,0	-3,0	1,0	VB..1102..

Spare Parts

For size	Insert key	Insert screw	Insert shim	Shim screw
A16R-...11	T07P-2	C02506-T07P	-	-
A20S-...11	T07P-2	C02506-T07P	-	-
A25T-...11	T07P-2	C02506-T07P	-	-
A25S-...16	T15P-2	C03510-T15P	171.19-620	CA3507
A32T-...16	T15P-2	C03510-T15P	171.19-620	CA3507
A40U-...16	T15P-2	C03510-T15P	171.19-620	CA3507

General ISO Turning Holders
Steadyline®
MDT
Mini-Shaft™
Grooving
Parting-off
X4
Adapters Clamping units
Accessories and Spare parts
Workpiece materials

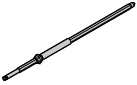
Accessories

For size	Insert clamping torque 	Replacement blade 	Shim key 	Torque key 
A16R-...11	0.9NM	T00-07P	-	T00-07P09
A20S-...11	0.9NM	T00-07P	-	T00-07P09
A25T-...11	0.9NM	T00-07P	-	T00-07P09
A25S-...16	3.0NM	T00-15P	9/64SMS875	T00-15P30
A32T-...16	3.0NM	T00-15P	9/64SMS875	T00-15P30
A40U-...16	3.0NM	T00-15P	9/64SMS875	T00-15P30

General ISO Turning
Holders

Steadyline®

MDT

Mini-Shaft™

Grooving

Parting-off

X4

Adapters
Clamping units

Accessories and
Spare parts

Workpiece
materials

SVQBR/L and SVUBR/L – Toolholders for inserts VBGT and VBMT – Inch

SVQBR
KAPR = 107,5 °

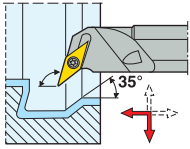

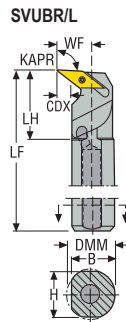
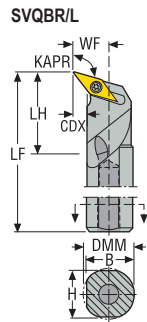
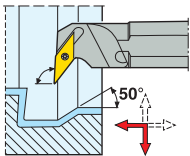

SVUBR/L
KAPR = 93,0 °





- For inserts program, see page(s) 563, 564
- GAMO° = Rake angle, LAMS° = Inclination angle
- CTWS = Insert shape and size
- For holder code key, see page(s) 21-22
- Right-hand version shown
- Please check availability at www.secotools.com / Seco Online Store

Designation	Item number	DMM	H	B	LF	WF	LH	DCINN	KAPR°	GAMO°	LAMS°	Weight	CTWS
		Inch	Inch	Inch	Inch	Inch	Inch	Inch				lbs	
A12-SVQBR-2	00002730	0.750	0.709	0.728	10.000	1.125	1.429	1.125	107,5	0,0	-5,0	1.320	VB..21.5.
A10-SVUBR-2	00002696	0.625	0.532	0.602	10.000	0.840	1.240	0.840	93,0	0,0	-7,0	0.880	VB..21.5.
A12-SVUBR-2	00002698	0.750	0.709	0.728	10.000	1.125	1.429	1.125	93,0	0,0	-5,0	1.320	VB..21.5.
A16-SVUBR-2	00002725	1.000	0.866	0.933	12.000	1.500	1.921	1.500	93,0	0,0	-3,0	2.430	VB..21.5.
A12-SVUBL-2	00002703	0.750	0.709	0.728	10.000	1.125	1.429	1.125	93,0	0,0	-5,0	1.320	VB..21.5.

Spare Parts

For size	Insert key	Insert screw
..-2	 T07P-2	 C02506-T07P

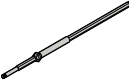
Accessories

For size	Insert clamping torque	Replacement blade	Torque key
..-2	 8.0IN.LBS	 T00-07P	 T00-07P09

General ISO Turning Holders
Steadyline®
MDT
Mini-Shaft™
Grooving
Parting-off
X4
Adapters Clamping units
Accessories and Spare parts
Workpiece materials

SWLCR/L – Toolholders for inserts WCMT – Metric

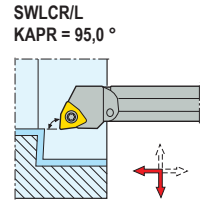
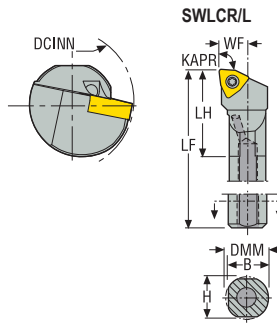

CTWS



- For inserts program, see page(s) 567
- GAMO° = Rake angle, LAMS° = Inclination angle
- CTWS = Insert shape and size
- For holder code key, see page(s) 19-20
- Right-hand version shown
- Please check availability at www.secotools.com / Seco Online Store

Designation	Item number	DMM	H	B	LF	WF	LH	DCINN	KAPR°	GAMO°	LAMS°	Weight	CTWS
		mm	mm	mm	mm	mm	mm	mm				kg	
A16M-SWLCR06	75034418	16,0	15	16	150	11,0	21,0	20,0	95,0	0,0	-5,0	0,2	WCMT06T3..
A20Q-SWLCR06	75055235	20,0	18	19	180	13,0	37,0	25,0	95,0	0,0	-5,0	0,4	WCMT06T3..
A16M-SWLCR06	75034442	16,0	15	16	150	11,0	21,0	20,0	95,0	0,0	-5,0	0,2	WCMT06T3..
A20Q-SWLCR06	75055236	20,0	18	19	180	13,0	37,0	25,0	95,0	0,0	-5,0	0,4	WCMT06T3..

Spare Parts

For size	Insert key	Insert screw
A16M-...06	T15P-2	C03508-T15P
A20Q-...06	T15P-2	C03508-T15P

Accessories

For size	Insert clamping torque	Replacement blade	Torque key
A16M-...06	3.0NM	T00-15P	T00-15P30
A20Q-...06	3.0NM	T00-15P	T00-15P30

General ISO Turning Holders
Steadyline®
MDT
Mini-Shaft™
Grooving
Parting-off
X4
Adapters Clamping units
Accessories and Spare parts
Workpiece materials

MCLNR/L – Toolholders for inserts CNGA, CNGG, CNMA, CNMG, CNMM and CNMN – Metric

MCLNR/L
KAPR = 95,0°

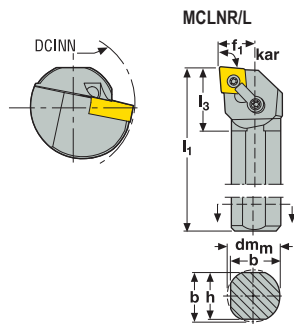
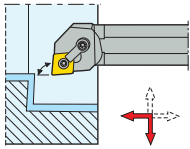

CTWS



- For inserts program, see page(s) 527, 528, 529, 530, 531, 532, 533, 575, 576
- GAMO° = Rake angle, LAMS° = Inclination angle
- CTWS = Insert shape and size
- For holder code key, see page(s) 19-20
- Right-hand version shown
- Please check availability at www.secotools.com / Seco Online Store

Designation	Item number	DMM	H	B	LF	WF	LH	DCINN	KAPR°	GAMO°	LAMS°	Weight	CTWS
		mm	mm	mm	mm	mm	mm	mm				kg	
S25S-MCLNR12	75002242	25,0	23	24	250	17,0	40,0	32,0	95,0	-5,0	-14,0	0,9	CN..1204..
S32T-MCLNR12	75002244	32,0	30	31	300	22,0	50,0	40,0	95,0	-5,0	-14,0	1,8	CN..1204..
S40U-MCLNR12	75071545	40,0	37	39	350	27,0	50,0	50,0	95,0	-5,0	-14,0	3,3	CN..1204..
S25S-MCLNL12	75002243	25,0	23	24	250	17,0	40,0	32,0	95,0	-5,0	-14,0	0,9	CN..1204..
S32T-MCLNL12	75002245	32,0	30	31	300	22,0	50,0	40,0	95,0	-5,0	-14,0	1,8	CN..1204..
S40U-MCLNL12	75002247	40,0	37	39	350	27,0	50,0	50,0	95,0	-5,0	-14,0	3,3	CN..1204..
S50V-MCLNR16	00018830	50,0	47	49	400	35,0	70,0	63,0	95,0	-5,0	-14,0	5,9	CN..1606..
S50V-MCLNL16	00018816	50,0	47	49	400	35,0	70,0	63,0	95,0	-5,0	-14,0	5,9	CN..1606..
S50V-MCLNR19	00018833	50,0	47	49	400	35,0	70,0	63,0	95,0	-5,0	-14,0	5,9	CN..1906..
S50V-MCLNL19	00018820	50,0	47	49	400	35,0	70,0	63,0	95,0	-5,0	-14,0	5,8	CN..1906..

Spare Parts

For size	Cantilever clamp	Clamp screw	Insert/Clamp key	Insert pin	Insert shim	Shim/clamp key	Shim pin
S25S-...12	MC20	LD6020-T15P	T15P-2	MN1215S-T15P	-	-	-
S32T-...12	MC20	LD6020-T15P	-	-	CSN120412	T15P-2	MN1215R-T15P
S40U-...12	MC20	LD6020-T15P	-	-	CSN120412	T15P-2	MN1215R-T15P
-...16	MC12	LD8030-T25P	-	-	CSN160412	T25P-7	MN1515-T15P
-...19	MC12	LD8030-T25P	-	-	CSN190412	T25P-7	MN1925-T25P

Accessories

For size	Insert clamping torque	Plug	Replacement blade	Shim key	Shim screw	Torque key
S25S-...12	3.0NM	P3	T00-15P	-	-	T00-15P30
S32T-...12	3.0NM	P3	T00-15P	-	CS6313-T15P	T00-15P30
S40U-...12	3.0NM	P3	T00-15P	-	CS6313-T15P	T00-15P30
-...16	6.0NM	P4	T00T-25P	T15P-2	CS8016-T15P	T00T-25P60
-...19	6.0NM	P4	T00T-25P	-	-	T00T-25P60

MCLNR/L – Toolholders for inserts CNGA, CNGP, CNMA, CNMG, CNMM, CNMN and CNMP – Inch

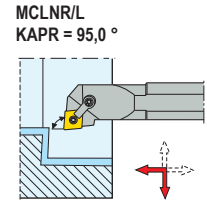
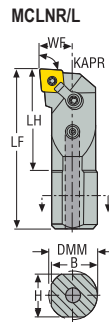

CTWS



- For inserts program, see page(s) 527, 528, 529, 530, 531, 532, 533, 575, 576
- GAMO° = Rake angle, LAMS° = Inclination angle
- CTWS = Insert shape and size
- For holder code key, see page(s) 21-22
- Right-hand version shown
- Please check availability at www.secotools.com / Seco Online Store

Designation	Item number	DMM	H	B	LF	WF	LH	DCINN	KAPR°	GAMO°	LAMS°	Weight	CTWS
		Inch	Inch	Inch	Inch	Inch	Inch	Inch				lbs	
A16-MCLNR-4	00012116	1.000	0.921	0.961	12.000	0.640	1.260	1.280	95,0	-5,0	-14,0	2.430	CN..43.
A20-MCLNR-4	00041050	1.250	1.171	1.211	14.000	0.765	2.134	1.530	95,0	-5,0	-14,0	4.410	CN..43.
A24-MCLNR-4	00041052	1.500	0.902	1.461	14.000	0.890	2.224	1.780	95,0	-5,0	-12,0	6.170	CN..43.
A32-MCLNR-4	00002683	2.000	1.882	1.941	16.000	1.281	2.413	2.559	95,0	-5,0	-12,0	13.450	CN..43.
A16-MCLNL-4	00012112	1.000	0.921	0.961	12.000	0.640	1.496	1.280	95,0	-5,0	-14,0	2.430	CN..43.
A20-MCLNL-4	00041051	1.250	1.171	1.211	14.000	0.765	2.134	1.530	95,0	-5,0	-14,0	4.410	CN..43.
A24-MCLNL-4	00041053	1.500	0.902	1.461	14.000	0.890	2.224	1.780	95,0	-5,0	-12,0	6.390	CN..43.
A32-MCLNL-4	00002684	2.000	1.882	1.941	16.000	1.281	2.413	2.559	95,0	-5,0	-12,0	13.230	CN..43.
A32-MCLNR-5	00012118	2.000	1.882	1.941	16.000	1.281	2.413	2.559	95,0	-5,0	-12,0	13.450	CN..54.
A32-MCLNL-5	00012114	2.000	1.882	1.941	16.000	1.281	2.413	2.559	95,0	-5,0	-12,0	13.230	CN..54.

Spare Parts

For size	Cantilever clamp	Clamp screw	Coolant port	Insert pin	Insert shim
16/ 20-4	CL-20	XNS-47	CP-0800	NL-44	-
24/ 32-4	CL-20	XNS-47	CP-0800	NL-46	CSN-432
32-5	CL-12	XNS-510	CP-0800	NL-58	CSN-533

MCLNR/L – Toolholders for inserts CNGA, CNGP, CNMA, CNMG, CNMM, CNMN and CNMP – Inch

MCLNR/L
KAPR = 95,0°

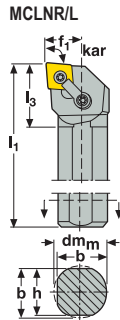
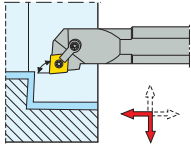



CTWS



- For inserts program, see page(s) 527, 528, 529, 530, 531, 532, 533, 575, 576
- GAMO° = Rake angle, LAMS° = Inclination angle
- CTWS = Insert shape and size
- For holder code key, see page(s) 21-22
- Right-hand version shown
- Please check availability at www.secotools.com / Seco Online Store

Designation	Item number	DMM	H	B	LF	WF	LH	DCINN	KAPR°	GAMO°	LAMS°	Weight	CTWS
		Inch	Inch	Inch	Inch	Inch	Inch	Inch				lbs	
S12-MCLNR-3	00043201	0.750	0.709	0.728	10.000	0.500	1.750	1.000	95,0	-5,0	-14,0	1.320	CN..32.
S12-MCLNL-3	00043196	0.750	0.709	0.728	10.000	0.500	1.750	1.000	95,0	-5,0	-14,0	1.320	CN..32.
S16-MCLNR-4	00043203	1.000	0.807	0.866	12.000	0.640	0.965	1.280	95,0	-5,0	-14,0	2.650	CN..43.
S20-MCLNR-4	00043204	1.252	1.122	1.142	14.000	0.765	1.168	1.520	95,0	-5,0	-14,0	5.070	CN..43.
S24-MCLNR-4	00043205	1.500	1.299	1.338	14.000	0.890	1.203	1.780	95,0	-5,0	-14,0	6.610	CN..43.
S16-MCLNL-4	00043198	1.000	0.807	0.866	12.000	0.640	0.965	1.280	95,0	-5,0	-14,0	2.650	CN..43.

Spare Parts

For size	Cantilever clamp	Clamp screw	Insert pin	Insert shim
..-3	 CL-7	 XNS-35	 NL-33	-
16-..R-4	CLM-20	XNS-47	NL-44	-
20-..R-4	CL-20	XNS-47	NL-44	-
24-..R-4	CL-20	XNS-47	NL-46	CSN-432
16-..L-4	CL-20	XNS-47	NL-44	-

General ISO Turning Holders
Steadyline®
MDT
Mini-Shaft™
Grooving
Parting-off
X4
Adapters Clamping units
Accessories and Spare parts
Workpiece materials

MDUNR/L – Toolholders for inserts DNGA, DNGM, DNGP, DNMA, DNMG, DNMM and DNMP – Inch

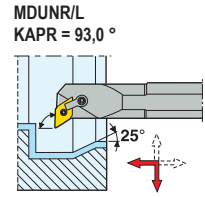
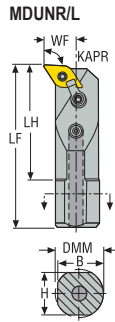

CTWS



- For inserts program, see page(s) 537, 538, 539, 540, 541, 579, 580, 598
- GAMO° = Rake angle, LAMS° = Inclination angle
- CTWS = Insert shape and size
- For holder code key, see page(s) 21-22
- Right-hand version shown
- * Use the right shim & the right screw for the selected insert. For details, see page 99
- Please check availability at www.secotools.com / Seco Online Store

Designation	Item number	DMM	H	B	LF	WF	LH	DCINN	KAPR°	GAMO°	LAMS°	Weight	CTWS
		Inch	Inch	Inch	Inch	Inch	Inch	Inch				lbs	
A24-MDUNR-4	00041064	1.500	1.339	1.419	14.000	1.125	2.141	2.250	93,0	-5,0	-10,0	6.610	DN..43/DN..44*
A32-MDUNR-4	00043209	2.000	1.880	1.940	16.000	1.375	2.756	3.000	93,0	-5,0	-10,0	13.230	DN..43/DN..44*
A24-MDUNL-4	00041065	1.500	1.339	1.419	14.000	1.125	2.141	2.250	93,0	-5,0	-10,0	6.390	DN..43/DN..44*

Spare Parts

For size	Cantilever clamp	Clamp screw	Coolant port	Insert pin	Insert shim
24...4	CL-12	XNS59	CP-0800	NL-46	DSN-433
32...4	CL-12	XNS59	CP-0800	NL-46	DSN-423

Accessories

For size	Insert shim
24...4	DSN-423
32...4	DSN-433

MDUNR/L – Toolholders for inserts DNGA, DNGM, DNGP, DNMA, DNMG, DNMM, DNMP and DNMU – Inch



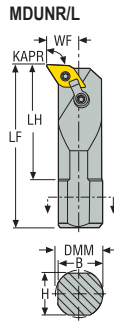
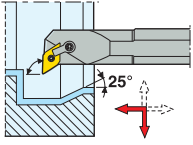





MDUNR/L
KAPR = 93,0°



- For inserts program, see page(s) 537, 538, 539, 540, 541, 579, 580, 598
- GAMO° = Rake angle, LAMS° = Inclination angle
- CTWS = Insert shape and size
- For holder code key, see page(s) 21-22
- Right-hand version shown
- Please check availability at www.secotools.com / Seco Online Store

Designation	Item number	DMM	H	B	LF	WF	LH	DCINN	KAPR°	GAMO°	LAMS°	Weight	CTWS
		Inch	Inch	Inch	Inch	Inch	Inch	Inch				lbs	
S16-MDUNR-3	75056416	1.000	0.846	0.866	12.000	0.750	0.906	1.300	93,0	-5,0	-14,0	2.650	DN..33.
S12-MDUNL-3	75056415	0.750	0.689	0.708	10.000	0.562	0.800	0.980	93,0	-5,0	-14,0	1.320	DN..33.

Spare Parts

For size	Cantilever clamp	Clamp screw	Insert pin	Insert shim
16-..R-3	 CL-20	 XNS-46	 NL-34L	 DSN-323
12-..L-3	 CL-6	 XNS-36	 NL-34L	 DSN-323

General ISO Turning Holders
Steadyline®
MDT
Mini-Shaft™
Grooving
Parting-off
X4
Adapters Clamping units
Accessories and Spare parts
Workpiece materials

MSKNR/L – Toolholders for inserts SNGA, SNGN, SNMA, SNMG and SNMM – Metric

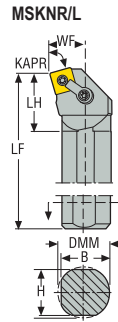
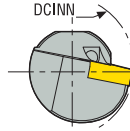

MSKNR/L
KAPR = 75,0 °

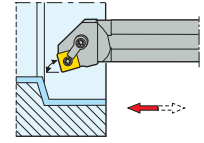

CTWS



- For inserts program, see page(s) 550, 551, 552, 553, 585, 586
- GAMO° = Rake angle, LAMS° = Inclination angle
- CTWS = Insert shape and size
- For holder code key, see page(s) 19-20
- Right-hand version shown
- Please check availability at www.secotools.com / Seco Online Store

Designation	Item number	DMM	H	B	LF	WF	LH	DCINN	KAPR°	GAMO°	LAMS°	Weight	CTWS
		mm	mm	mm	mm	mm	mm	mm				kg	
S32T-MSKNR12	75002262	32,0	30	31	300	22,0	50,0	40,0	75,0	-5,0	-13,0	1,8	SN..1204..
S40U-MSKNR12	75002264	40,0	37	39	350	27,0	60,0	50,0	75,0	-5,0	-12,0	3,3	SN..1204..
S32T-MSKNL12	75002263	32,0	30	31	300	22,0	50,0	40,0	75,0	-5,0	-13,0	1,8	SN..1204..
S40U-MSKNL12	75002265	40,0	37	39	350	27,0	60,0	50,0	75,0	-5,0	-12,0	3,3	SN..1204..
S50V-MSKNR15	00018835	50,0	47	49	400	35,0	55,0	63,0	75,0	-5,0	-12,0	5,9	SN..1506..
S50V-MSKNL15	00018834	50,0	47	49	400	35,0	55,0	63,0	75,0	-5,0	-12,0	5,9	SN..1506..

Spare Parts

For size	Cantilever clamp	Clamp key	Clamp screw	Insert shim	Shim/clamp key	Shim pin
...12	MC20	-	LD6020-T15P	SSN120412	T15P-2	MN1215R-T15P
...15	MC12	T25P-7	LD8025-T25P	SSN150412	-	MN1515-T15P

Accessories

For size	Insert clamping torque	Plug	Replacement blade	Shim key	Shim screw	Torque key
...12	3.0NM	P3	T00-15P	-	CS6313-T15P	T00-15P30
...15	6.0NM	P4	T00T-25P	T15P-2	CS8016-T15P	T00T-25P60

MTFNR/L – Toolholders for inserts TNGA, TNMA, TNMG and TNMM – Metric

MTFNR/L
KAPR = 90,0°

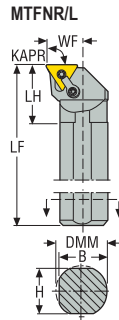
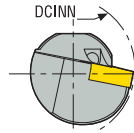
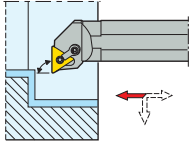

- For inserts program, see page(s) 558, 559, 560, 561, 590
- GAMO° = Rake angle, LAMS° = Inclination angle
- CTWS = Insert shape and size
- For holder code key, see page(s) 19-20
- Shim TSN160412 for insert TN..1603.., to be ordered separately
- Right-hand version shown
- Please check availability at www.secotools.com / Seco Online Store

Designation	Item number	DMM	H	B	LF	WF	LH	DCINN	KAPR°	GAMO°	LAMS°	Weight	CTWS
		mm	mm	mm	mm	mm	mm	mm				kg	
S32T-MTFNR16	75002272	32,0	30	31	300	22,0	50,0	40,0	90,0	-5,0	-14,0	1,9	TN..1604..
S32T-MTFNL16	75002273	32,0	30	31	300	22,0	50,0	40,0	90,0	-5,0	-14,0	1,9	TN..1604..

Spare Parts

For size	Cantilever clamp	Clamp screw	Insert shim	Shim/clamp key	Shim pin
...16	 MC06	 LD5020-T09P	 TSN160312	 T09P-2	 MN0909L-T09P

Accessories

For size	Insert clamping torque	Replacement blade	Shim screw	Torque key
...16	 2.0NM	 T00-09P	 CS5008-T09P	 T00-09P20

General ISO Turning
Holders

Steadyline®

MDT

Mini-Shaft™

Grooving

Parting-off

X4

Adapters
Clamping units

Accessories and
Spare parts

Workpiece
materials

MTFNR/L – Toolholders for inserts TNGA, TNGN, TNMA, TNMG, TNMM, TNMN and TNMP – Inch

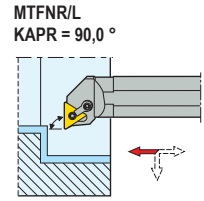
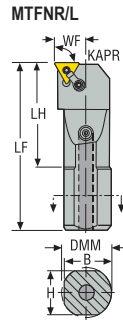

CTWS



- For inserts program, see page(s) 558, 559, 560, 561, 590, 592
- GAMO° = Rake angle, LAMS° = Inclination angle
- CTWS = Insert shape and size
- For holder code key, see page(s) 21-22
- Right-hand version shown
- Please check availability at www.secotools.com / Seco Online Store

Designation	Item number	DMM	H	B	LF	WF	LH	DCINN	KAPR°	GAMO°	LAMS°	Weight	CTWS
		Inch	Inch	Inch	Inch	Inch	Inch	Inch				lbs	
A16-MTFNR-3	00041090	1.000	0.866	0.933	12.000	0.640	1.924	1.280	90,0	-5,0	-12,0	2.650	TN..33.
A20-MTFNR-3	00041092	1.250	0.472	0.571	14.000	0.765	1.902	1.530	90,0	-5,0	-12,0	4.850	TN..33.
A24-MTFNR-4	00041094	1.500	1.339	1.419	14.000	1.031	1.969	2.559	90,0	-5,0	-10,0	6.170	TN..43.
A32-MTFNR-4	00041098	2.000	1.880	1.940	16.000	1.292	2.203	2.559	90,0	-5,0	-8,0	13.230	TN..43.

Spare Parts

For size	Cantilever clamp	Clamp screw	Coolant port	Insert pin	Insert shim
...3	CL-7	XNS-35	CP-0800	NL-33L	–
...4	CL-9	XNS59	CP-0800	NL-46	ITSN-433

Accessories

For size	Insert shim
...3	–
...4	TS-424

General ISO Turning Holders
Steadyline®
MDT
Mini-Shaft™
Grooving
Parting-off
X4
Adapters Clamping units
Accessories and Spare parts
Workpiece materials

MTFNR/L – Toolholders for inserts TNGA, TNGN, TNMA, TNMG, TNMM, TNMN and TNMP – Inch

MTFNR/L
KAPR = 90,0°

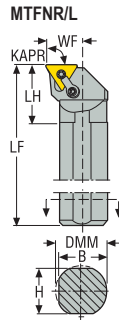
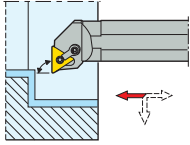

- For inserts program, see page(s) 558, 559, 560, 561, 590, 591, 592
- GAMO° = Rake angle, LAMS° = Inclination angle
- CTWS = Insert shape and size
- For holder code key, see page(s) 21-22
- Right-hand version shown
- Please check availability at www.secotools.com / Seco Online Store

Designation	Item number	DMM	H	B	LF	WF	LH	DCINN	KAPR°	GAMO°	LAMS°	Weight	CTWS
		Inch	Inch	Inch	Inch	Inch	Inch	Inch				lbs	
S12-MTFNR-3	00043212	0.750	0.650	0.707	10.000	0.500	1.750	1.000	90,0	-5,0	-14,0	1.540	TN..33.
S16-MTFNR-3	00043214	1.000	0.846	0.866	12.000	0.640	0.906	1.280	90,0	-5,0	-13,0	2.650	TN..33.

Spare Parts

For size	Cantilever clamp	Clamp screw	Insert pin
..-3	 CL-7	 XNS-35	 NL-33L

General ISO Turning Holders
Steadyline®
MDT
Mini-Shaft™
Grooving
Parting-off
X4
Adapters Clamping units
Accessories and Spare parts
Workpiece materials

MTUNR/L – Toolholders for inserts TNGA, TNGN, TNMA, TNMG, TNMM, TNMN and TNMX – Inch

General ISO Turning
Holders

Steadyline®

MDT

Mini-Shaft™

Grooving

Parting-off

X4

Adapters
Clamping units

Accessories and
Spare parts

Workpiece
materials

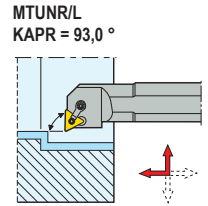
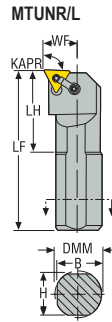

CTWS



- For inserts program, see page(s) 558, 559, 560, 561, 590, 591, 592
- GAMO° = Rake angle, LAMS° = Inclination angle
- CTWS = Insert shape and size
- For holder code key, see page(s) 21-22
- Right-hand version shown
- Please check availability at www.secotools.com / Seco Online Store

Designation	Item number	DMM	H	B	LF	WF	LH	DCINN	KAPR°	GAMO°	LAMS°	Weight	CTWS
		Inch	Inch	Inch	Inch	Inch	Inch	Inch				lbs	
S20-MTUNR-3	00043220	1.250	1.142	1.205	14.016	0.765	2.122	1.530	93,0	-5,0	-11,0	5.070	TN..32.

Spare Parts

For size	Cantilever clamp	Clamp screw	Insert pin	Insert shim
...3	 CL-7	 XNS-35	 NL-34	 ITSN-323

MVPNR/L and MVLNR/L – Toolholders for inserts VNGA, VNGG, VNGM, VNMA and VNMG – Metric

MVPNR/L
KAPR = 117,5°

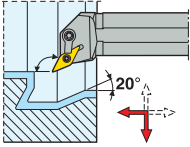

MVLNR/L
KAPR = 95,0°

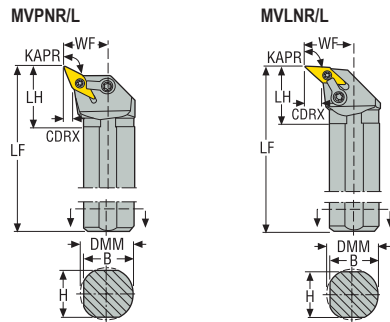
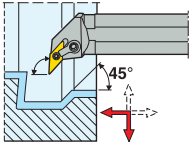

- For inserts program, see page(s) 565, 566, 595
- GAMO° = Rake angle, LAMS° = Inclination angle
- CTWS = Insert shape and size
- For holder code key, see page(s) 19-20
- Right-hand version shown
- Please check availability at www.secotools.com / Seco Online Store

Designation	Item number	DMM	H	B	LF	WF	LH	CDRX	DCINN	KAPR°	GAMO°	LAMS°	Weight	CTWS
		mm	mm	mm	mm	mm	mm	mm	mm				kg	
S32T-MVPNR16	75002282	32,0	30	31	300	27,0	50,0	10,0	46,0	117,5	-5,0	-12,0	1,8	VN..1604..
S32T-MVPLN16	75002283	32,0	30	31	300	27,0	50,0	10,0	46,0	117,5	-5,0	-12,0	1,8	VN..1604..
S32T-MVLNR16	75002280	32,0	30	31	300	30,0	50,0	13,0	48,0	95,0	-5,0	-12,0	1,8	VN..1604..
S32T-MVLNL16	75002281	32,0	30	31	300	30,0	50,0	13,0	48,0	95,0	-5,0	-12,0	1,8	VN..1604..

Spare Parts

For size	Cantilever clamp	Clamp screw	Insert shim	Shim/clamp key	Shim pin
...16	 MC20	 LD6021-T09P	 VSN160316	 T09P-2	 MN0909L-T09P

Accessories

For size	Insert clamping torque	Replacement blade	Torque key
...16	 2.0NM	 T00-09P	 T00-09P20

MVPNR/L and MVLNR/L – Toolholders for inserts VNGA, VNGM, VNGP, VNMA, VNMG, VNMN and VNMP – Inch

General ISO Turning
Holders

Steadyline®

MDT

Mini-Shaft™

Grooving

Parting-off

X4

Adapters
Clamping units

Accessories and
Spare parts

Workpiece
materials

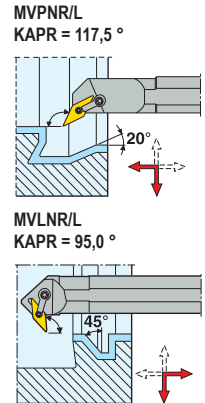
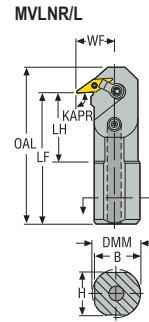
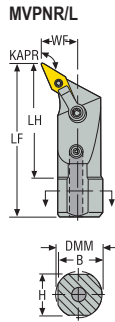











CTWS



- For inserts program, see page(s) 565, 566, 595
- GAMO° = Rake angle, LAMS° = Inclination angle
- CTWS = Insert shape and size
- For holder code key, see page(s) 21-22
- Right-hand version shown
- Please check availability at www.secotools.com / Seco Online Store

Designation	Item number	DMM	H	B	LF	OAL	WF	LH	DCINN	KAPR°	GAMO°	LAMS°	Weight	CTWS
		Inch	Inch	Inch	Inch	Inch	Inch	Inch	Inch	Inch			lbs	
A20-MVPNR-3	00041126	1.250	1.142	1.196	14.000	–	0.875	3.000	1.750	117,5	-5,0	-12,0	4.410	VN..33.
A32-MVPNR-3	00041128	2.000	1.880	1.940	16.000	–	1.250	3.356	2.500	117,5	-5,0	-12,0	12.790	VN..33.
A20-MVPNL-3	00041127	1.250	1.142	1.196	14.000	–	0.875	3.000	1.750	117,5	-5,0	-12,0	4.630	VN..33.
A32-MVPNL-3	00041129	2.000	1.880	1.940	16.000	–	1.250	3.356	2.500	117,5	-5,0	-12,0	13.010	VN..33.
A24-MVLNR-3	00041118	1.500	1.339	1.419	14.000	14.795	1.125	2.620	2.248	95,0	-5,0	-12,0	6.830	VN..33.
A24-MVLNL-3	00041119	1.500	1.339	1.419	14.000	14.795	1.125	2.620	2.248	95,0	-5,0	-12,0	6.830	VN..33.

Spare Parts

For size	Cantilever clamp	Clamp screw	Coolant port	Insert pin	Insert shim
MVPNR/L	 CL-30	 XNS58	 CP-0800	 NL-34L	 IVSN-324
MVLNR/L	 CL-20	 XNS-47	 CP-0800	 NL-34L	 IVSN-324

MVUNR/L – Toolholders for inserts VNGA, VNGM, VNGP, VNMA, VNMG, VNMN and VNMP – Inch

MVUNR/L
KAPR = 93,0°

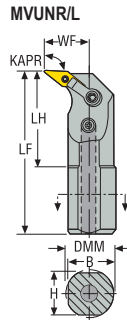
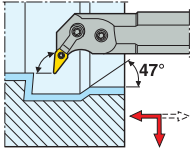





CTWS



- For inserts program, see page(s) 565, 566, 595
- GAMO° = Rake angle, LAMS° = Inclination angle
- CTWS = Insert shape and size
- For holder code key, see page(s) 21-22
- Right-hand version shown
- Please check availability at www.secotools.com / Seco Online Store

Designation	Item number	DMM	H	B	LF	WF	LH	DCINN	KAPR°	GAMO°	LAMS°	Weight	CTWS
		Inch	Inch	Inch	Inch	Inch	Inch	Inch				lbs	
A20-MVUNR-3	00041106	1.250	1.142	1.196	14.000	1.125	1.969	2.250	93,0	-5,0	-12,0	4.630	VN..33.
A24-MVUNR-3	00041108	1.500	1.339	1.419	14.000	1.250	1.969	2.062	93,0	-5,0	-12,0	6.390	VN..33.
A32-MVUNR-4	00041112	2.000	1.880	1.940	16.000	1.625	1.969	3.250	93,0	-5,0	-12,0	13.450	VN..43.

Spare Parts

For size	Cantilever clamp	Clamp screw	Coolant port	Insert pin	Insert shim
..-3	 CL-30	 XNS-510	 CP-0800	 NL-34L	 IVSN-324
..-4	CL-30	XNS-510	CP-0800	NL-46	IVSN-433

General ISO Turning Holders
Steadyline®
MDT
Mini-Shaft™
Grooving
Parting-off
X4
Adapters Clamping units
Accessories and Spare parts
Workpiece materials

MVYNR/L – Toolholders for inserts VNGA, VNGG, VNGM, VNMA and VNMG – Metric

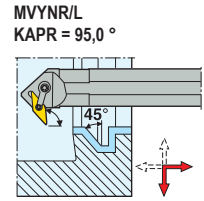
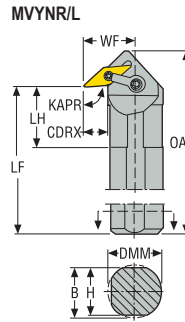

CTWS



- For inserts program, see page(s) 565, 566, 595
- GAMO° = Rake angle, LAMS° = Inclination angle
- CTWS = Insert shape and size
- For holder code key, see page(s) 19-20
- Right-hand version shown
- Please check availability at www.secotools.com / Seco Online Store

Designation	Item number	DMM	H	B	OAL	LF	WF	LH	CDX	DCINN	KAPR°	GAMO°	LAMS°	Weight	CTWS
		mm	mm	mm	mm	mm	mm	mm	mm	mm				kg	
S32T-MVYNR16	75002284	32,0	30	31	320	301	29,88	50,0	13,0	48,0	95,0	-5,0	-12,0	2,0	VN..1604..
S32T-MVYNL16	75002285	32,0	30	31	320	300	30,0	50,0	13,0	48,0	95,0	-5,0	-12,0	2,0	VN..1604..

Spare Parts

For size	Cantilever clamp	Clamp screw	Insert shim	Shim/clamp key	Shim pin
...16	 MC20	 LD6021-T09P	 VSN160316	 T09P-2	 MN0909L-T09P

Accessories

For size	Insert clamping torque	Replacement blade	Torque key
...16	 2.0NM	 T00-09P	 T00-09P20

General ISO Turning Holders
Steadyline®
MDT
Mini-Shaft™
Grooving
Parting-off
X4
Adapters Clamping units
Accessories and Spare parts
Workpiece materials

MWLNRL/L – Toolholders for inserts WNGA, WNGG, WNMA, WNMG and WNMM – Metric

MWLNRL/L
KAPR = 95,0°

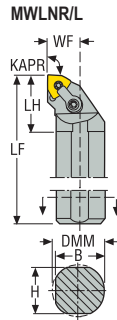
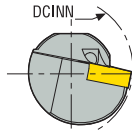
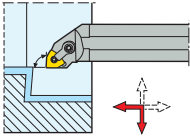

- For inserts program, see page(s) 568, 569, 570, 571, 596
- GAMO° = Rake angle, LAMS° = Inclination angle
- CTWS = Insert shape and size
- For holder code key, see page(s) 19-20
- Right-hand version shown
- * Use the right shim & the right screw for the selected insert. For details, see page 99
- Please check availability at www.secotools.com / Seco Online Store

Designation	Item number	DMM	H	B	LF	WF	LH	DCINN	KAPR°	GAMO°	LAMS°	Weight	CTWS
		mm	mm	mm	mm	mm	mm	mm				kg	
S25S-MWLNRL08	75002963	25,0	23	24	250	17,0	40,0	32,0	95,0	-5,0	-11,0	0,9	WN..0804/WN..0806*
S32T-MWLNRL08	75002965	32,0	30	31	300	22,0	50,0	40,0	95,0	-5,0	-14,0	1,8	WN..0804/WN..0806*
S40U-MWLNRL08	75002967	40,0	37	39	350	27,0	50,0	50,0	95,0	-5,0	-12,0	3,2	WN..0804/WN..0806*
S25S-MWLNRL08	75002964	25,0	23	24	250	17,0	40,0	32,0	95,0	-5,0	-11,0	0,9	WN..0804/WN..0806*
S32T-MWLNRL08	75002966	32,0	30	31	300	22,0	50,0	40,0	95,0	-5,0	-14,0	1,8	WN..0804/WN..0806*
S40U-MWLNRL08	75002968	40,0	37	39	350	27,0	50,0	50,0	95,0	-5,0	-12,0	3,2	WN..0804/WN..0806*

Spare Parts

For size	Cantilever clamp	Clamp screw	Insert/Clamp key	Insert pin	Insert shim	Shim/clamp key	Shim pin
S25S-...08	MC20	LD6020-T15P	T15P-2	MN1215S-T15P	–	–	–
S32T-...08	MC21	LD6025-T15P	–	–	MWN080412	T15P-2	MN1215T-T15P
S40U-...08	MC21	LD6025-T15P	–	–	MWN080412	T15P-2	MN1215T-T15P

Accessories

For size	Insert clamping torque	Plug	Replacement blade	Torque key
S25S-...08	3.0NM	P3	T00-15P	T00-15P30
S32T-...08	3.0NM	P3	T00-15P	T00-15P30
S40U-...08	3.0NM	P3	T00-15P	T00-15P30

General ISO Turning Holders
Steadyline®
MDT
Mini-Shaft™
Grooving
Parting-off
X4
Adapters Clamping units
Accessories and Spare parts
Workpiece materials

MWLNRL/L – Toolholders for inserts WNGA, WNGP, WNMA, WNMG, WNMM and WNMP – Inch

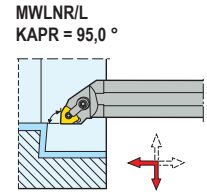
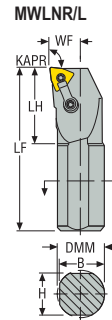

CTWS



- For inserts program, see page(s) 568, 569, 570, 571, 596
- GAMO° = Rake angle, LAMS° = Inclination angle
- CTWS = Insert shape and size
- For holder code key, see page(s) 21-22
- Right-hand version shown
- * Use the right shim & the right screw for the selected insert. For details, see page 99
- Please check availability at www.secotools.com / Seco Online Store

Designation	Item number	DMM	H	B	LF	WF	LH	DCINN	KAPR°	GAMO°	LAMS°	Weight	CTWS
		Inch	Inch	Inch	Inch	Inch	Inch	Inch				lbs	
A32-MWLNRL-4	00014792	2.000	1.882	1.941	16.000	1.281	2.230	2.559	95,0	-5,0	-12,0	13.450	WN..43/WN..44*
A32-MWLNRL-4	00014793	2.000	1.882	1.941	16.000	1.281	2.230	2.559	95,0	-5,0	-12,0	13.450	WN..43/WN..44*

Spare Parts

For size	Cantilever clamp	Clamp screw	Coolant port	Insert pin	Insert shim
..4	CL-20	XNS-47	CP-0800	NL-46	IWSN-433

Accessories

For size	Insert pin	Insert shim
..4	NL-46L	IWSN-423

General ISO Turning Holders
Steadyline®
MDT
Mini-Shaft™
Grooving
Parting-off
X4
Adapters Clamping units
Accessories and Spare parts
Workpiece materials

MWLN/L – Toolholders for inserts WNGA, WNGP, WNMA, WNMG, WNMM and WNMP – Inch

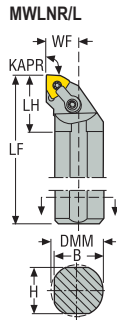
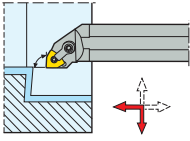

MWLN/L
KAPR = 95,0°



- For inserts program, see page(s) 568, 569, 570, 571, 596
- GAMO° = Rake angle, LAMS° = Inclination angle
- CTWS = Insert shape and size
- For holder code key, see page(s) 21-22
- Right-hand version shown
- * Use the right shim & the right screw for the selected insert. For details, see page 99
- Please check availability at www.secotools.com / Seco Online Store

Designation	Item number	DMM	H	B	LF	WF	LH	DCINN	KAPR°	GAMO°	LAMS°	Weight	CTWS
		Inch	Inch	Inch	Inch	Inch	Inch	Inch				lbs	
S12-MWLN/L-3	75051589	0.750	0.709	0.728	10.000	0.500	1.752	0.930	95,0	-5,0	-14,0	1.320	WN..33.
S16-MWLN/L-3	75051590	1.000	0.846	0.866	12.000	0.640	0.906	1.200	95,0	-5,0	-14,0	2.650	WN..33.
S20-MWLN/L-3	75051591	1.250	1.122	1.142	14.000	0.765	1.173	1.470	95,0	-5,0	-14,0	5.070	WN..33.
S12-MWLN/L-4	75051592	0.750	0.709	0.728	10.000	0.500	1.752	0.930	95,0	-5,0	-14,0	1.320	WN..33.
S16-MWLN/L-4	75051593	1.000	0.846	0.866	12.000	0.640	0.906	1.200	95,0	-5,0	-14,0	3.090	WN..33.
S20-MWLN/L-4	75051595	1.250	1.122	1.142	14.000	0.765	1.173	1.470	95,0	-5,0	-14,0	5.070	WN..33.
S16-MWLN/L-4	00043225	1.000	0.846	0.866	12.000	0.640	0.901	1.280	95,0	-5,0	-14,0	2.650	WN..43/WN..44*
S20-MWLN/L-4	00043226	1.250	1.122	1.142	14.000	0.765	1.173	1.470	95,0	-5,0	-14,0	5.070	WN..43/WN..44*
S24-MWLN/L-4	00043227	1.500	1.319	1.339	14.000	0.890	1.188	1.780	95,0	-5,0	-13,0	5.070	WN..43/WN..44*
S16-MWLN/L-4	00043222	1.000	0.846	0.866	12.000	0.640	0.901	1.280	95,0	-5,0	-14,0	2.650	WN..43/WN..44*
S20-MWLN/L-4	00043223	1.250	1.122	1.142	14.000	0.765	1.173	1.470	95,0	-5,0	-14,0	5.070	WN..43/WN..44*
S24-MWLN/L-4	00043224	1.500	1.319	1.339	14.000	0.890	1.188	1.780	95,0	-5,0	-13,0	6.830	WN..43/WN..44*

Spare Parts

For size	Cantilever clamp	Clamp screw	Insert pin	Insert shim
12/ 16-3	 CL-6	 XNS-36	 NL-33L	-
20-3	CL-6	XNS-36	NL-34L	IWSN-323
16-4	XNS-47	CL-20	NL-44	-
20/ 24-4	CL-20	XNS-47	NL-46	IWSN-433

Accessories

For size	Insert pin	Insert shim
12/ 16-3	 -	 -
20-3	-	-
16-4	-	-
20/ 24-4	NL-46L	IWSN-423

General ISO Turning
Holders

Steadyline®

MDT

Mini-Shaft™

Grooving

Parting-off

X4

Adapters
Clamping units

Accessories and
Spare parts

Workpiece
materials

CCLNR/L – Toolholders for PCBN inserts CNMN – Metric

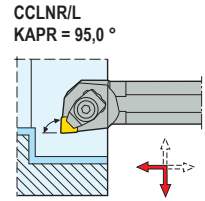
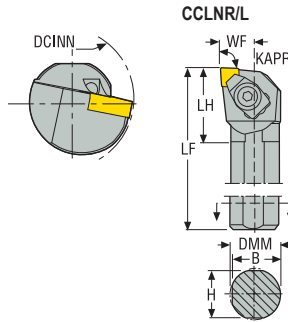

CTWS



- For inserts program, see page(s) 577
- GAMO° = Rake angle, LAMS° = Inclination angle
- CTWS = Insert shape and size
- For holder code key, see page(s) 19-20
- Right-hand version shown
- Please check availability at www.secotools.com / Seco Online Store

Designation	Item number	DMM	H	B	LF	WF	LH	DCINN	KAPR°	GAMO°	LAMS°	Weight	CTWS
		mm	mm	mm	mm	mm	mm	mm				kg	
S25R-CCLNR09	75069268	25,0	23	24	200	17,0	40,0	32,0	95,0	-6,0	-12,0	0,8	CN.N0903..
S32S-CCLNR09	75069270	32,0	30	31	250	22,0	44,0	40,0	95,0	-6,0	-12,0	1,5	CN.N0903..
S25R-CCLNL09	75069269	25,0	23	24	200	17,0	40,0	32,0	95,0	-6,0	-12,0	0,8	CN.N0903..
S32S-CCLNL09	75069271	32,0	30	31	250	22,0	44,0	40,0	95,0	-6,0	-12,0	1,5	CN.N0903..

Spare Parts

For size	Cantilever clamp	Clamp key	Insert shim	Shim screw
...09	 CC14	 4SMS795	 CCN090316	 174.10-652-T07P

Accessories

For size	Shim key
...09	 T07P-2

General ISO Turning Holders
Steadyline®
MDT
Mini-Shaft™
Grooving
Parting-off
X4
Adapters Clamping units
Accessories and Spare parts
Workpiece materials

CRSNR/L – Toolholders for PCBN inserts RNGN and RNMN – Metric

CRSNR/L
KAPR = 45,0°

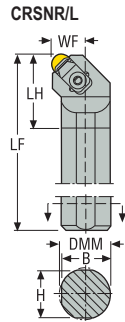
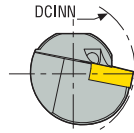
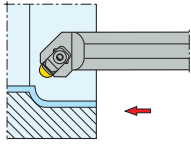





CTWS



- For inserts program, see page(s) 582, 601, 604
- GAMO° = Rake angle, LAMS° = Inclination angle
- CTWS = Insert shape and size
- For holder code key, see page(s) 19-20
- Right-hand version shown
- Please check availability at www.secotools.com / Seco Online Store

Designation	Item number	DMM	H	B	LF	WF	LH	DCINN	KAPR°	GAMO°	LAMS°	Weight	CTWS
		mm	mm	mm	mm	mm	mm	mm				kg	
S25R-CRSNR06	75069272	25,0	23	24	200	17,0	37,0	32,0	45,0	-6,0	-12,0	0,8	RN.N0603..
S32S-CRSNR06	75069278	32,0	30	31	250	22,0	40,0	40,0	45,0	-6,0	-12,0	1,6	RN.N0603..
S40T-CRSNR06	75069280	40,0	37	39	300	27,0	40,0	50,0	45,0	-6,0	-12,0	2,8	RN.N0603..
S25R-CRSNL06	75069273	25,0	23	24	200	17,0	37,0	32,0	45,0	-6,0	-12,0	0,8	RN.N0603..
S32S-CRSNL06	75069279	32,0	30	31	250	22,0	40,0	40,0	45,0	-6,0	-12,0	1,6	RN.N0603..
S40T-CRSNL06	75069281	40,0	37	39	300	27,0	40,0	50,0	45,0	-6,0	-12,0	2,8	RN.N0603..
S32S-CRSNR09	75069286	32,0	30	31	250	22,0	40,0	40,0	45,0	-6,0	-12,0	1,5	RN.N0903..
S40T-CRSNR09	75069276	40,0	37	39	300	27,0	43,0	50,0	45,0	-6,0	-12,0	2,8	RN.N0903..
S32S-CRSNL09	75069287	32,0	30	31	250	22,0	40,0	40,0	45,0	-6,0	-12,0	1,6	RN.N0903..
S40T-CRSNL09	75069277	40,0	37	39	300	27,0	43,0	50,0	45,0	-6,0	-12,0	2,8	RN.N0903..

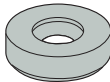
Spare Parts

For size	Cantilever clamp	Clamp key	Insert shim	Shim screw
...06	 CC14	 4SMS795	 CRN0603M0	 CS2507-T07P
...09	CC16	4SMS795	117.10-620	174.10-652-T07P

Accessories

For size	Shim key
...06	 T07P-2
...09	T07P-2

General ISO Turning
Holders

Steadyline®

MDT

Mini-Shaft™

Grooving

Parting-off

X4

Adapters
Clamping units

Accessories and
Spare parts

Workpiece
materials

CSKNR/L – Toolholders for PCBN inserts SNGF, SNGN and SNMN – Metric

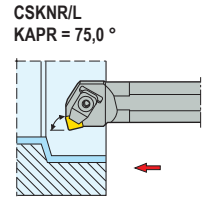
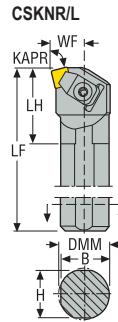
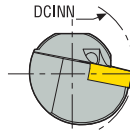

CTWS



- For inserts program, see page(s) 585
- GAMO° = Rake angle, LAMS° = Inclination angle
- CTWS = Insert shape and size
- For holder code key, see page(s) 19-20
- Right-hand version shown
- Please check availability at www.secotools.com / Seco Online Store

Designation	Item number	DMM	H	B	LF	WF	LH	DCINN	KAPR°	GAMO°	LAMS°	Weight	CTWS
		mm	mm	mm	mm	mm	mm	mm				kg	
S25R-CSKNR09	75069282	25,0	23	24	200	17,0	35,0	32,0	75,0	-6,0	-12,0	0,8	SN.N0903..

Spare Parts

For size	Cantilever clamp	Clamp key	Insert shim	Shim screw
S25R-...09	CC14	4SMS795	174.10-620	174.10-652-T07P

Accessories

For size	Shim key
S25R-...09	T07P-2

General ISO Turning Holders
Steadyline®
MDT
Mini-Shaft™
Grooving
Parting-off
X4
Adapters Clamping units
Accessories and Spare parts
Workpiece materials

CTUNR/L – Toolholders for PCBN inserts TNGN, TNGX, TNMN and TNMX – Metric

CTUNR/L
KAPR = 93,0°

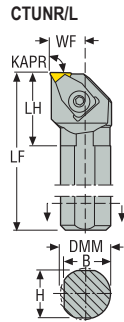
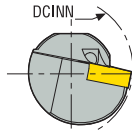
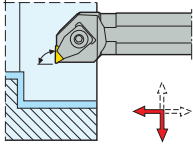

- For inserts program, see page(s) 558, 559, 560, 561, 591
- GAMO° = Rake angle, LAMS° = Inclination angle
- CTWS = Insert shape and size
- For holder code key, see page(s) 19-20
- Shim CTN110312 for insert TN.N110312 and TNMX110308S-WZ, to be ordered separately
- Right-hand version shown
- Please check availability at www.secotools.com / Seco Online Store

Designation	Item number	DMM	H	B	LF	WF	LH	DCINN	KAPR°	GAMO°	LAMS°	Weight	CTWS
		mm	mm	mm	mm	mm	mm	mm				kg	
S25R-CTUNR11	75069290	25,0	23	24	200	17,0	40,0	32,0	93,0	-6,0	-10,0	0,8	TN.N/TN.X1103..
S32S-CTUNR11	75069292	32,0	30	31	250	22,0	40,0	40,0	93,0	-6,0	-10,0	1,5	TN.N/TN.X1103..
S25R-CTUNL11	75069291	25,0	23	24	200	17,0	40,0	32,0	93,0	-6,0	-10,0	0,8	TN.N/TN.X1103..
S32S-CTUNL11	75069293	32,0	30	31	250	22,0	40,0	40,0	93,0	-6,0	-10,0	1,5	TN.N/TN.X1103..

Spare Parts

For size	Cantilever clamp	Clamp key	Insert shim	Shim screw
...11	 CC14	 4SMS795	 CTN110308	 CS2507-T07P

Accessories

For size	Shim key
...11	 T07P-2

General ISO Turning Holders
Steadyline®
MDT
Mini-Shaft™
Grooving
Parting-off
X4
Adapters Clamping units
Accessories and Spare parts
Workpiece materials

DDUNR/L..-C – Toolholders for PCBN inserts DNMA – Metric

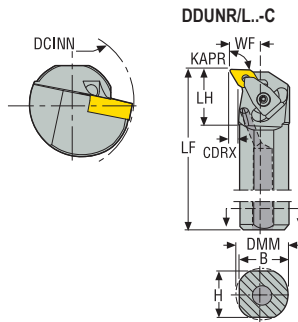

DDUNR/L..-C
KAPR = 93,0 °

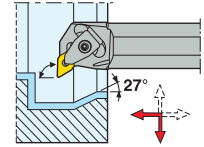

CTWS



- For inserts program, see page(s) 537, 538, 539, 540, 541, 580
- GAMO° = Rake angle, LAMS° = Inclination angle
- CTWS = Insert shape and size
- For holder code key, see page(s) 19-20
- Right-hand version shown
- Please check availability at www.secotools.com / Seco Online Store

Designation	Item number	DMM	H	B	LF	WF	LH	CDX	DCINN	KAPR°	GAMO°	LAMS°	Weight	CTWS
		mm	mm	mm	mm	mm	mm	mm	mm				kg	
A25R-DDUNR11-C	02598549	25,0	23	24	200	17,0	27,0	4,0	32,0	93,0	-6,0	-13,0	0,7	DNMA1104..
A25R-DDUNL11-C	02598552	25,0	23	24	200	17,0	27,0	4,0	32,0	93,0	-6,0	-13,0	0,7	DNMA1104..
A32S-DDUNL11-C	02598613	32,0	30	31	250	22,0	31,0	6,0	40,0	93,0	-5,0	-11,0	1,4	DNMA1104..

Spare Parts

For size	Clamp pin	Clamp screw	Floating wedge clamp	Insert shim	Shim/clamp key	Shim screw	Spring
...11	FP1508	L84017-T09P	CC09P-D11	DDN110310	T09P-2	C03007-T09P	S5608

Accessories

For size	Clamp kit	Insert clamping torque	Replacement blade	Torque key
...11	CC09P-SET	2.0NM	T00-09P	T00-09P20

General ISO Turning Holders
Steadyline®
MDT
Mini-Shaft™
Grooving
Parting-off
X4
Adapters Clamping units
Accessories and Spare parts
Workpiece materials

SCACL and SCECL – Toolholders for inserts CCGT, CCGW, CCGX, CCMT and CCMW – Metric

SCACL
KAPR = 90,0°

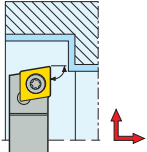

SCECL
KAPR = 60,0°

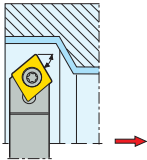

SCACL

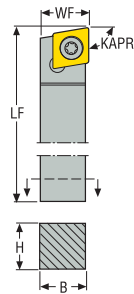

SCECL

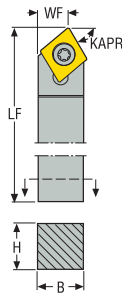

CTWS



- For inserts program, see page(s) 522, 523, 524, 525, 573, 574, 597, 599
- GAMO° = Rake angle, LAMS° = Inclination angle
- CTWS = Insert shape and size
- For holder code key, see page(s) 15-16
- Left-hand version shown
- Please check availability at www.secotools.com / Seco Online Store

Designation	Item number	H	DMM	B	LF	WF	KAPR°	GAMO°	LAMS°	Weight	CTWS
		mm	mm	mm	mm	mm				kg	
SCACL1212D09	75011223	12	-	12	60	13,0	90,0	0,0	0,0	0,1	CC..09T3..
SCECL1010C06	75011225	10	-	10	50	6,2	60,0	0,0	0,0	0,1	CC..0602..

Spare Parts

For size	Insert key	Insert screw
...09	T15P-2	C04008-T15P
...06	T07P-2	C02506-T07P

Accessories

For size	Insert clamping torque	Replacement blade	Torque key
...09	3.5NM	T00-15P	T00-15P35
...06	0.9NM	T00-07P	T00-07P09

General ISO Turning
Holders

Steadyline®

MDT

Mini-Shaft™

Grooving

Parting-off

X4

Adapters
Clamping units

Accessories and
Spare parts

Workpiece
materials

SCACL and SCECL – Toolholders for inserts CCGT, CCGW, CCMT and CCMW – Metric

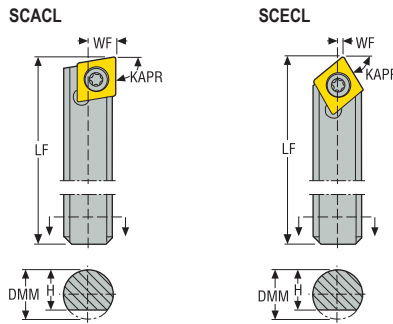

SCACL
KAPR = 90,0 °

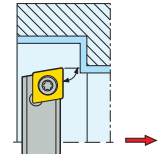

SCECL
KAPR = 60,0 °

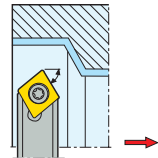

CTWS



- For inserts program, see page(s) 522, 523, 524, 525, 573, 574, 597, 599
- GAMO° = Rake angle, LAMS° = Inclination angle
- CTWS = Insert shape and size
- For holder code key, see page(s) 19-20
- Left-hand version shown
- Please check availability at www.secotools.com / Seco Online Store

Designation	Item number	H	DMM	B	LF	WF	KAPR°	GAMO°	LAMS°	Weight	CTWS
		mm	mm	mm	mm	mm				kg	
S08A-SCACL06	75011125	6	8,0	–	32	4,2	90,0	0,0	0,0	0,1	CC..0602..
S10C-SCACL06	75011127	8	10,0	–	50	5,2	90,0	0,0	0,0	0,1	CC..0602..
S12D-SCACL09	75011129	10	12,0	–	60	6,7	90,0	0,0	0,0	0,1	CC..09T3..
S08A-SCECL06	75011131	6	8,0	–	32	1,5	60,0	0,0	0,0	0,1	CC..0602..
S10C-SCECL06	75011133	8	10,0	–	50	2,4	60,0	0,0	0,0	0,1	CC..0602..
S12D-SCECL09	75011135	10	12,0	–	60	2,3	60,0	0,0	0,0	0,1	CC..09T3..

Spare Parts

For size	Insert key	Insert screw
S08A-...06	T07P-2	C02505-T07P
S10C-...06	T07P-2	C02506-T07P
...09	T15P-2	C04008-T15P

Accessories

For size	Insert clamping torque	Replacement blade	Torque key
S08A-...06	0.9NM	T00-07P	T00-07P09
S10C-...06	0.9NM	T00-07P	T00-07P09
...09	3.5NM	T00-15P	T00-15P35

SCDCL – Toolholders for inserts CCGT, CCGW, CCMT and CCMW – Metric

SCDCL
KAPR = 45,0°

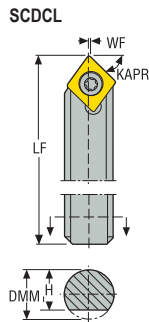
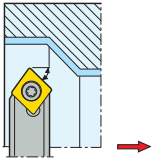

- For inserts program, see page(s) 522, 523, 524, 525, 573, 574, 597, 599
- GAMO° = Rake angle, LAMS° = Inclination angle
- CTWS = Insert shape and size
- For holder code key, see page(s) 19-20
- Left-hand version shown
- Please check availability at www.secotools.com / Seco Online Store

Designation	Item number	H	DMM	B	LF	WF	KAPR°	GAMO°	LAMS°	Weight	CTWS
		mm	mm	mm	mm	mm				kg	
S08A-SCDCL06	75011161	6	8,0	–	32	0,3	45,0	0,0	0,0	0,1	CC..0602..
S10C-SCDCL06	75011137	8	10,0	–	50	1,2	45,0	0,0	0,0	0,1	CC..0602..
S12D-SCDCL09	75011163	10	12,0	–	60	0,5	45,0	0,0	0,0	0,1	CC..09T3..

Spare Parts

For size	Insert key	Insert screw
S08A-...06	T07P-2	C02505-T07P
S10C-...06	T07P-2	C02506-T07P
...09	T15P-2	C04008-T15P

Accessories

For size	Insert clamping torque	Replacement blade	Torque key
S08A-...06	0.9NM	T00-07P	T00-07P09
S10C-...06	0.9NM	T00-07P	T00-07P09
...09	3.5NM	T00-15P	T00-15P35

General ISO Turning
Holders

Steadyline®

MDT

Mini-Shaft™

Grooving

Parting-off

X4

Adapters
Clamping units

Accessories and
Spare parts

Workpiece
materials

SCLCR/L, SCFCR/L and SCWCR/L – Cartridges for inserts CCGT, CCGW, CCGX, CCMT and CCMW – Metric/ Inch

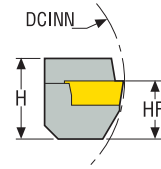
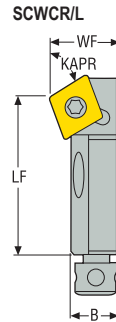
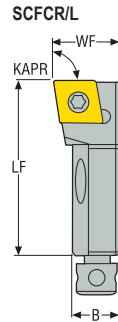
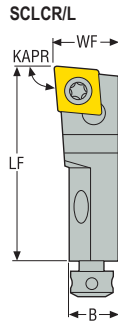

CTWS







- For inserts program, see page(s) 522, 523, 524, 525, 573, 574, 597, 599
- GAMO° = Rake angle, LAMS° = Inclination angle
- CTWS = Insert shape and size
- For cartridge mounting information see page 122
- Right-hand version shown
- Please check availability at www.secotools.com / Seco Online Store

Designation	Item number	H	B	LF	WF	HF	DCINN	KAPR°	GAMO°	LAMS°	Weight	CTWS
		mm Inch	mm Inch	mm Inch	mm Inch	mm Inch	mm Inch	mm Inch	kg lbs			
SCLCR10CA-09	75011811	15 0.591	11 0.433	50 1.969	13,96 0.550	10,0 0.394	40,0 1.575	95,0	0,0	0,0	0,1 0.220	CC..09T3.. CC..32.5
SCLCL10CA-09	00009143	15 0.591	11 0.433	50 1.969	14,0 0.551	10,0 0.394	40,0 1.575	95,0	0,0	0,0	0,1 0.220	CC..09T3.. CC..32.5
SCLCR12CA-12	00013239	20 0.787	16 0.630	55 2.165	20,0 0.787	12,0 0.472	50,0 1.969	95,0	0,0	0,0	0,1 0.220	CC..1204.. CC..43
SCLCL12CA-12	75606498	20 0.787	16 0.630	55 2.165	20,0 0.787	12,0 0.472	50,0 1.969	95,0	0,0	0,0	0,1 0.220	CC..1204.. CC..43
SCFCR08CA-06	75029427	11 0.433	7 0.276	26 1.024	10,0 0.394	8,0 0.315	25,0 0.984	90,0	0,0	0,0	0,1 0.220	CC..0602.. CC..21.5
SCFCL08CA-06	00008880	11 0.433	7 0.276	26 1.024	10,0 0.394	8,0 0.315	25,0 0.984	90,0	0,0	0,0	0,1 0.220	CC..0602.. CC..21.5
SCFCR10CA-09	75011682	15 0.591	11 0.433	50 1.969	13,96 0.550	10,0 0.394	40,0 1.575	90,0	0,0	0,0	0,1 0.220	CC..09T3.. CC..32.5
SCFCL10CA-09	75011810	15 0.591	11 0.433	50 1.969	13,96 0.550	10,0 0.394	40,0 1.575	90,0	0,0	0,0	0,1 0.220	CC..09T3.. CC..32.5
SCFCR12CA-12	75011863	20 0.787	16 0.630	55 2.165	19,96 0.786	12,0 0.472	50,0 1.969	90,0	0,0	0,0	0,1 0.220	CC..1204.. CC..43
SCFCL12CA-12	75011864	20 0.787	16 0.630	55 2.165	19,96 0.786	12,0 0.472	50,0 1.969	90,0	0,0	0,0	0,1 0.220	CC..1204.. CC..43
SCWCL08CA-06	00008682	11 0.433	7 0.276	28 1.102	9,96 0.392	8,0 0.315	25,0 0.984	60,0	0,0	0,0	0,1 0.220	CC..0602.. CC..21.5
SCWCR10CA-09	00008694	15 0.591	11 0.433	44 1.732	13,96 0.550	10,0 0.394	40,0 1.575	60,0	0,0	0,0	0,1 0.220	CC..09T3.. CC..32.5
SCWCL10CA-09	00008698	15 0.591	11 0.433	44 1.732	13,96 0.550	10,0 0.394	40,0 1.575	60,0	0,0	0,0	0,1 0.220	CC..09T3.. CC..32.5

Spare Parts

For size	Insert key	Insert screw	Locking screw	Setting screw (axial)	Setting screw (radial)
-09	T15P-2	C04008-T15P	179.17-696-T25P	179.17-680	179.17-686
-12	T20P-7	C05010-T20P	179.17-697-T25P	179.17-680	179.17-687
-06	T07P-2	C02505-T07P	179.17-698-T09P	179.17-683	179.17-684

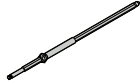
Accessories

For size	Insert clamping torque	Locking key	Replacement blade	Setting key	Torque key
-09	3.5NM 	 T25P-7	 T00-15P	 2SMS795	 T00-15P35
-12	5.0NM	T25P-7	T00-20P	2SMS795	T00-20P50
-06	0.9NM	T09P-2	T00-07P	1.5SMS795	T00-07P09

General ISO Turning
Holders

Steadyline®

MDT

Mini-Shaft™

Grooving

Parting-off

X4

Adapters
Clamping units

Accessories and
Spare parts

Workpiece
materials

SCSCR/L and SCGCR/L – Cartridges for inserts CCGT, CCGW, CCGX, CCMT and CCMW – Metric/ Inch

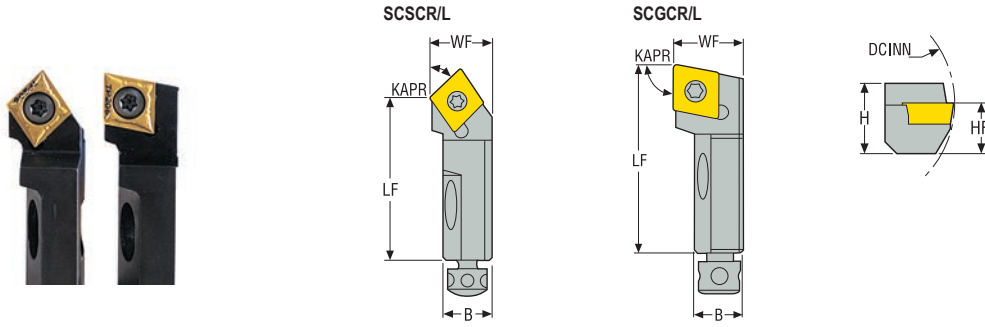

CTWS



- For inserts program, see page(s) 522, 523, 524, 525, 573, 574, 597, 599
- GAMO° = Rake angle, LAMS° = Inclination angle
- CTWS = Insert shape and size
- For cartridge mounting information see page 122
- Right-hand version shown
- Please check availability at www.secotools.com / Seco Online Store

Designation	Item number	H	B	LF	WF	HF	DCINN	KAPR°	GAMO°	LAMS°	Weight	CTWS
		mm Inch	mm Inch	mm Inch	mm Inch	mm Inch	mm Inch				kg lbs	
SCSCR08CA-06	00008677	11 0.433	7 0.276	28 1.102	9,96 0.392	8,0 0.315	25,0 0.984	45,0	0,0	0,0	0,1 0.220	CC..0602.. CC..21.5
SCSCL08CA-06	00008877	11 0.433	7 0.276	28 1.102	9,96 0.392	8,0 0.315	25,0 0.984	45,0	0,0	0,0	0,1 0.220	CC..0602.. CC..21.5
SCSCR10CA-09	00034179	15 0.591	11 0.433	44 1.732	13,96 0.550	10,0 0.394	40,0 1.575	45,0	0,0	0,0	0,1 0.220	CC..09T3.. CC..32.5
SCSCR12CA-12	75011862	20 0.787	16 0.630	47 1.850	20,0 0.787	12,0 0.472	50,0 1.969	45,0	0,0	0,0	0,1 0.220	CC..1204.. CC..43
SCGCR08CA-06	00009129	11 0.433	7 0.276	32 1.260	9,96 0.392	8,0 0.315	25,0 0.984	90,0	0,0	0,0	0,1 0.220	CC..0602.. CC..21.5
SCGCL08CA-06	00008883	11 0.433	7 0.276	32 1.260	9,96 0.392	8,0 0.315	25,0 0.984	90,0	0,0	0,0	0,1 0.220	CC..0602.. CC..21.5
SCGCR10CA-09	00009131	15 0.591	11 0.433	50 1.969	13,96 0.550	10,0 0.394	40,0 1.575	90,0	0,0	0,0	0,1 0.220	CC..09T3.. CC..32.5
SCGCR12CA-12	75011860	20 0.787	16 0.630	55 2.165	19,96 0.786	12,0 0.472	50,0 1.969	90,0	0,0	0,0	0,1 0.220	CC..1204.. CC..43
SCGCL12CA-12	00045802	20 0.787	16 0.630	55 2.165	19,96 0.786	12,0 0.472	50,0 1.969	90,0	0,0	0,0	0,1 0.220	CC..1204.. CC..43

Spare Parts

For size	Insert key	Insert screw	Locking screw	Setting screw (axial)	Setting screw (radial)
-06	 T07P-2	 C02505-T07P	 179.17-698-T09P	 179.17-683	 179.17-684
-09	T15P-2	C04008-T15P	179.17-696-T25P	179.17-680	179.17-686
-12	T20P-7	C05010-T20P	179.17-697-T25P	179.17-680	179.17-687

Accessories

For size	Insert clamping torque	Locking key	Replacement blade	Setting key	Torque key
-06	 0.9NM	 T09P-2	 T00-07P	 1.5SMS795	 T00-07P09
-09	3.5NM	T25P-7	T00-15P	2SMS795	T00-15P35
-12	5.0NM	T25P-7	T00-20P	2SMS795	T00-20P50

SCRCR/L and SCTCR/L – Cartridges for inserts CCGT, CCGW, CCGX, CCMT and CCMW – Metric / Inch

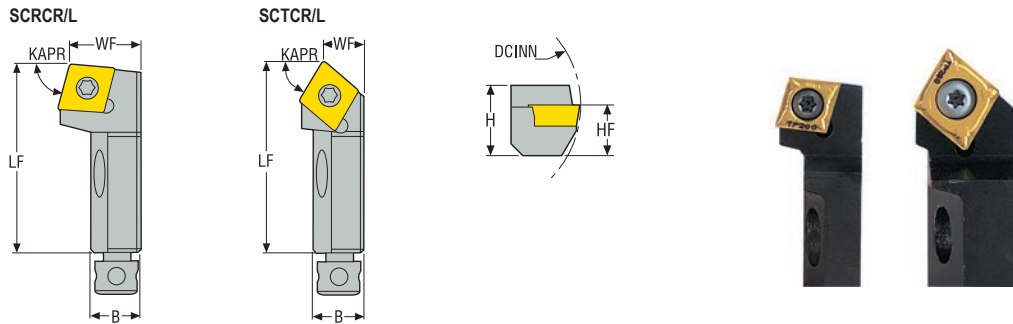

- For inserts program, see page(s) 522, 523, 524, 525, 573, 574, 597, 599
- GAMO° = Rake angle, LAMS° = Inclination angle
- CTWS = Insert shape and size
- For cartridge mounting information see page 122
- Right-hand version shown
- Please check availability at www.secotools.com / Seco Online Store

Designation	Item number	H	B	LF	WF	HF	DCINN	KAPR°	GAMO°	LAMS°	Weight	CTWS
		mm Inch	mm Inch	mm Inch	mm Inch	mm Inch	mm Inch				kg lbs	
SCRCR10CA-09	00008684	15 0.591	11 0.433	50 1.969	13,96 0.550	10,0 0.394	40,0 1.575	75,0	0,0	0,0	0,1 0.220	CC..09T3.. CC..32.5
SCRCL10CA-09	00008685	15 0.591	11 0.433	50 1.969	13,96 0.550	10,0 0.394	40,0 1.575	75,0	0,0	0,0	0,1 0.220	CC..09T3.. CC..32.5
SCTCR08CA-06	00008891	11 0.433	7 0.276	26 1.024	6,0 0.236	8,0 0.315	25,0 0.984	60,0	0,0	0,0	0,1 0.220	CC..0602.. CC..21.5
SCTCR10CA-09	00034258	15 0.591	11 0.433	50 1.969	8,96 0.353	10,0 0.394	40,0 1.575	60,0	0,0	0,0	0,1 0.220	CC..09T3.. CC..32.5
SCTCL10CA-09	00008689	15 0.591	11 0.433	50 1.969	8,96 0.353	10,0 0.394	40,0 1.575	60,0	0,0	0,0	0,1 0.220	CC..09T3.. CC..32.5
SCTCR12CA-12	00008705	20 0.787	16 0.630	55 2.165	13,0 0.512	12,0 0.472	50,0 1.969	60,0	0,0	0,0	0,1 0.220	CC..1204.. CC..43
SCTCL12CA-12	00008720	20 0.787	16 0.630	55 2.165	13,0 0.512	12,0 0.472	50,0 1.969	60,0	0,0	0,0	0,1 0.220	CC..1204.. CC..43

Spare Parts

For size	Insert key	Insert screw	Locking screw	Setting screw (axial)	Setting screw (radial)
-09	T15P-2	C04008-T15P	179.17-696-T25P	179.17-680	179.17-686
-06	T07P-2	C02505-T07P	179.17-698-T09P	179.17-683	179.17-684
-12	T20P-7	C05010-T20P	179.17-697-T25P	179.17-680	179.17-687

Accessories

For size	Insert clamping torque	Locking key	Replacement blade	Setting key	Torque key
-09	3.5NM	T25P-7	T00-15P	2SMS795	T00-15P35
-06	0.9NM	T09P-2	T00-07P	1.5SMS795	T00-07P09
-12	5.0NM	T25P-7	T00-20P	2SMS795	T00-20P50

General ISO Turning Holders
Steadyline®
MDT
Mini-Shaft™
Grooving
Parting-off
X4
Adapters Clamping units
Accessories and Spare parts
Workpiece materials

SSKCR/L – Cartridges for inserts SCGW and SCMT – Metric/ Inch

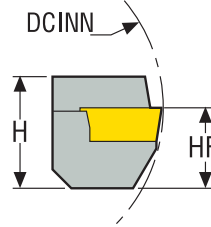
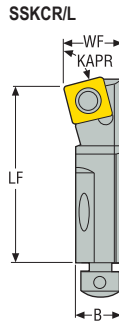

CTWS



- For inserts program, see page(s) 548, 549, 584
- GAMO° = Rake angle, LAMS° = Inclination angle
- CTWS = Insert shape and size
- For cartridge mounting information see page 122
- Right-hand version shown
- Please check availability at www.secotools.com / Seco Online Store

Designation	Item number	H	B	LF	WF	HF	DCINN	KAPR°	GAMO°	LAMS°	Weight	CTWS
		mm <i>Inch</i>	mm <i>Inch</i>	mm <i>Inch</i>	mm <i>Inch</i>	mm <i>Inch</i>	mm <i>Inch</i>				kg <i>lbs</i>	
SSKCR10CA-09	00009139	15 <i>0.591</i>	11 <i>0.433</i>	50 <i>1.969</i>	14,0 <i>0.551</i>	10,0 <i>0.394</i>	40,0 <i>1.575</i>	75,0	0,0	0,0	0,1 <i>0.220</i>	SC..09T3.. SC..32.5.
SSKCL10CA-09	75209709	15 <i>0.591</i>	11 <i>0.433</i>	50 <i>1.969</i>	14,0 <i>0.551</i>	10,0 <i>0.394</i>	40,0 <i>1.575</i>	75,0	0,0	0,0	0,1 <i>0.220</i>	SC..09T3.. SC..32.5.
SSKCR12CA-12	00009167	20 <i>0.787</i>	16 <i>0.630</i>	55 <i>2.165</i>	20,0 <i>0.787</i>	12,0 <i>0.472</i>	50,0 <i>1.969</i>	75,0	0,0	0,0	0,1 <i>0.220</i>	SC..1204.. SC..43.
SSKCR16CA-12	00009191	25 <i>0.984</i>	20 <i>0.787</i>	63 <i>2.480</i>	24,96 <i>0.983</i>	16,0 <i>0.630</i>	60,0 <i>2.362</i>	75,0	-4,0	0,0	0,2 <i>0.440</i>	SC..1204.. SC..43.

Spare Parts

For size	Insert key	Insert screw	Insert shim	Locking screw	Setting screw (axial)	Setting screw (radial)	Shim screw
-09	T15P-2	C04008-T15P	-	179.17-696-T25P	179.17-680	179.17-686	-
.12..-12	T20P-7	C05010-T20P	-	179.17-697-T25P	179.17-680	179.17-687	-
.16..-12	T15P-2	C05012-T15P	110.19-621	179.17-693	179.17-680	179.17-685	CA5008

Accessories

For size	Insert clamping torque	Locking key	Replacement blade	Setting key	Torque key
-09	3.5NM	T25P-7	T00-15P	2SMS795	T00-15P35
.12..-12	5.0NM	T25P-7	T00-20P	2SMS795	T00-20P50
.16..-12	5.0NM	5SMS795	T00-15P	2.5SMS795	T00-15P50

STFCR/L, STWCR/L and STSCR/L – Cartridges for inserts TCGT, TCMT and TCMW – Metric / Inch

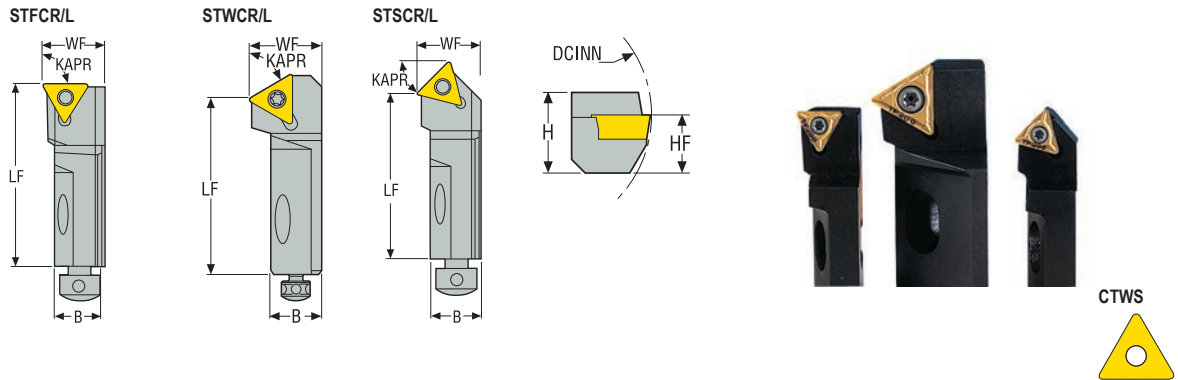

- For inserts program, see page(s) 555, 556, 601
- GAMO° = Rake angle, LAMS° = Inclination angle
- CTWS = Insert shape and size
- For cartridge mounting information see page 122
- Right-hand version shown
- Please check availability at www.secotools.com / Seco Online Store







Designation	Item number	H	B	LF	WF	HF	DCINN	KAPR°	GAMO°	LAMS°	Weight	CTWS
		mm Inch	mm Inch	mm Inch	mm Inch	mm Inch	mm Inch	mm Inch	kg lbs			
STFCR10CA-11	00009136	15 0.591	11 0.433	50 1.969	13,96 0.550	10,0 0.394	40,0 1.575	90,0	0,0	0,0	0,1 0.220	TC..1102.. TC..21.5.
STFCR12CA-11	00009166	20 0.787	16 0.630	55 2.165	19,96 0.786	12,0 0.472	50,0 1.969	90,0	0,0	0,0	0,1 0.220	TC..1102.. TC..21.5.
STFCL10CA-11	00009146	15 0.591	11 0.433	50 1.969	13,96 0.550	10,0 0.394	40,0 1.575	90,0	0,0	0,0	0,1 0.220	TC..1102.. TC..21.5.
STFCR16CA-16	00009184	25 0.984	20 0.787	63 2.480	25,0 0.984	16,0 0.630	60,0 2.362	90,0	-2,0	0,0	0,2 0.440	TC..16T3.. TC..32.5.
STFCL16CA-16	00009187	25 0.984	20 0.787	63 2.480	14,96 0.589	16,0 0.630	60,0 2.362	90,0	-2,0	0,0	0,2 0.440	TC..16T3.. TC..32.5.
STWCR16CA-16	00008753	25 0.984	20 0.787	53 2.087	24,96 0.983	16,0 0.630	60,0 2.362	60,0	0,0	0,0	0,2 0.440	TC..16T3.. TC..32.5.
STWCL16CA-16	00008754	25 0.984	20 0.787	53 2.087	24,96 0.983	16,0 0.630	60,0 2.362	60,0	0,0	0,0	0,2 0.440	TC..16T3.. TC..32.5.
STSCR10CA-11	00009140	15 0.591	11 0.433	44 1.732	14,0 0.551	10,0 0.394	40,0 1.575	45,0	0,0	0,0	0,1 0.220	TC..1102.. TC..21.5.
STSCL10CA-11	00009155	15 0.591	11 0.433	44 1.732	14,0 0.551	10,0 0.394	40,0 1.575	45,0	0,0	0,0	0,1 0.220	TC..1102.. TC..21.5.
STSCR12CA-16	00009171	20 0.787	16 0.630	47 1.850	19,96 0.786	12,0 0.472	50,0 1.969	45,0	0,0	0,0	0,1 0.220	TC..16T3.. TC..32.5.
STSCR16CA-16	00009192	25 0.984	20 0.787	53 2.087	24,96 0.983	16,0 0.630	60,0 2.362	45,0	-6,0	0,0	0,2 0.440	TC..16T3.. TC..32.5.
STSCL12CA-16	00009169	20 0.787	16 0.630	47 1.850	19,96 0.786	12,0 0.472	50,0 1.969	45,0	0,0	0,0	0,1 0.220	TC..16T3.. TC..32.5.
STSCL16CA-16	00009193	25 0.984	20 0.787	53 2.087	24,96 0.983	16,0 0.630	60,0 2.362	45,0	-6,0	0,0	0,2 0.440	TC..16T3.. TC..32.5.

Spare Parts

For size	Insert key	Insert screw	Insert shim	Locking screw	Setting screw (axial)	Setting screw (radial)	Shim screw
..10..-11	T07P-2	C02506-T07P	-	179.17-696-T25P	179.17-680	179.17-686	-
..12..-11	T07P-2	C02506-T07P	-	179.17-697-T25P	179.17-680	179.17-687	-
..16..-16	T15P-2	C03509-T15P	STN160312	179.17-693	179.17-680	179.17-685	CA3510
..12..-16	T15P-2	C03509-T15P	-	179.17-697-T25P	179.17-680	179.17-687	-

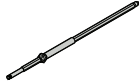
General ISO Turning Holders
Steadyline®
MDT
Mini-Shaft™
Grooving
Parting-off
X4
Adapters Clamping units
Accessories and Spare parts
Workpiece materials

Accessories

For size	Insert clamping torque 	Locking key 	Replacement blade 	Setting key 	Shim key 	Torque key 
..10..-11	0.9NM	T25P-7	T00-07P	2SMS795	-	T00-07P09
..12..-11	0.9NM	T25P-7	T00-07P	2SMS795	-	T00-07P09
..16..-16	3.0NM	5SMS795	T00-15P	2.5SMS795	9/64SMS875	T00-15P30
..12..-16	3.0NM	T25P-7	T00-15P	2SMS795	-	T00-15P30

General ISO Turning
Holders

Steadyline®

MDT

Mini-Shaft™

Grooving

Parting-off

X4

Adapters
Clamping units

Accessories and
Spare parts

Workpiece
materials

STGCR/L, STRCR/L and STTCR/L – Cartridges for inserts TCGT, TCGW, TCMT and TCMW – Metric / Inch

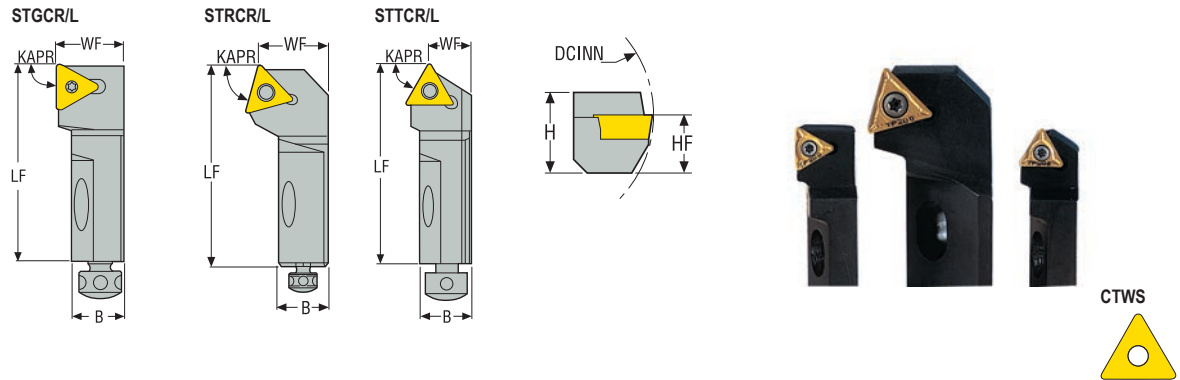

- For inserts program, see page(s) 555, 556, 589, 601
- GAMO° = Rake angle, LAMS° = Inclination angle
- CTWS = Insert shape and size
- For cartridge mounting information see page 122
- Right-hand version shown
- Please check availability at www.secotools.com / Seco Online Store







Designation	Item number	H	B	LF	WF	HF	DCINN	KAPR°	GAMO°	LAMS°	Weight	CTWS
		mm Inch	mm Inch	mm Inch	mm Inch	mm Inch	mm Inch	mm Inch	kg lbs			
STGCR12CA-16	00009175	20 0.787	16 0.630	55 2.165	19,96 0.786	12,0 0.472	50,0 1.969	90,0	0,0	0,0	0,1 0.220	TC..16T3.. TC..32.5.
STGCR16CA-16	00009196	25 0.984	20 0.787	63 2.480	24,96 0.983	16,0 0.630	60,0 2.362	90,0	-5,0	0,0	0,2 0.440	TC..16T3.. TC..32.5.
STGCL12CA-16	00009174	20 0.787	16 0.630	55 2.165	19,96 0.786	12,0 0.472	50,0 1.969	90,0	0,0	0,0	0,1 0.220	TC..16T3.. TC..32.5.
STGCL16CA-16	00009197	25 0.984	20 0.787	63 2.480	24,96 0.983	16,0 0.630	60,0 2.362	90,0	-5,0	0,0	0,2 0.440	TC..16T3.. TC..32.5.
STGCL16CA-22	02600181	20 0.787	18 0.689	55 2.165	25,0 0.984	16,0 0.630	50,0 1.969	90,0	0,0	0,0	0,2 0.440	TC..2204.. TC..43.
STRCR16CA-16	00008747	25 0.984	20 0.787	63 2.480	24,96 0.983	16,0 0.630	60,0 2.362	75,0	-5,0	0,0	0,2 0.440	TC..16T3.. TC..32.5.
STRCL16CA-16	00008750	25 0.984	20 0.787	63 2.480	24,96 0.983	16,0 0.630	60,0 2.362	75,0	-5,0	0,0	0,2 0.440	TC..16T3.. TC..32.5.
STRCL16CA-22	02585320	20 0.787	18 0.689	63 2.480	25,0 0.984	16,0 0.630	60,0 2.362	75,0	0,0	0,0	0,2 0.440	TC..2204.. TC..43.
STTCR12CA-16	00009172	20 0.787	16 0.630	55 2.165	12,96 0.510	12,0 0.472	50,0 1.969	60,0	0,0	0,0	0,1 0.220	TC..16T3.. TC..32.5.
STTCR16CA-16	00009195	25 0.984	20 0.787	63 2.480	14,96 0.589	16,0 0.630	60,0 2.362	60,0	-4,0	0,0	0,2 0.440	TC..16T3.. TC..32.5.
STTCL16CA-16	00009194	25 0.984	20 0.787	63 2.480	14,96 0.589	16,0 0.630	60,0 2.362	60,0	-4,0	0,0	0,2 0.440	TC..16T3.. TC..32.5.

Spare Parts

For size	Insert key	Insert screw	Insert shim	Locking screw	Setting screw (axial)	Setting screw (radial)	Shim screw
..12...16	T15P-2	C03509-T15P	-	179.17-697-T25P	179.17-680	179.17-687	-
..16...16	T15P-2	C03509-T15P	STN160312	179.17-693	179.17-680	179.17-685	CA3510
..16...22	T15P-2	C05012-T15P	-	179.17-693	179.17-680	179.17-690-T15P	-

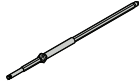
General ISO Turning Holders
Steadyline®
MDT
Mini-Shaft™
Grooving
Parting-off
X4
Adapters Clamping units
Accessories and Spare parts
Workpiece materials

Accessories

For size	Insert clamping torque	Locking key	Replacement blade	Setting key	Shim key	Torque key
..12..-16	3.0NM 	T25P-7 	T00-15P 	2SMS795 	- 	T00-15P30 
..16..-16	3.0NM	5SMS795	T00-15P	2.5SMS795	9/64SMS875	T00-15P30
..16..-22	5.0NM	5SMS795	T00-15P	2SMS795	-	T00-15P50

General ISO Turning
Holders

Steadyline®

MDT

Mini-Shaft™

Grooving

Parting-off

X4

Adapters
Clamping units

Accessories and
Spare parts

Workpiece
materials



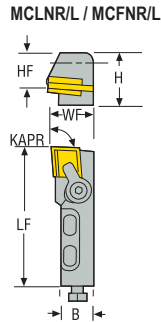









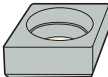



MCLNR/L and MCFNR/L – Cartridges for inserts CNGA, CNGN, CNGP, CNMA, CNMG, CNMM, CNMN and CNMP – Inch



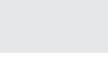

- For inserts program, see page(s) 527, 528, 529, 530, 531, 532, 533, 575, 576, 603
- GAMO° = Rake angle, LAMS° = Inclination angle
- CTWS = Insert shape and size
- For cartridge mounting information see page 122
- Right-hand version shown
- Please check availability at www.secotools.com / Seco Online Store

Designation	Item number	H	B	LF	WF	HF	DCINN	KAPR°	GAMO°	LAMS°	Weight	CTWS
		Inch	Inch	Inch	Inch	Inch	Inch				lbs	
MCLNR12CA-12	00041850	0.787	0.551	2.165	0.787	0.472	1.969	95,0	-5,0	-10,0	0.220	CN.43.
MCLNL-12CA-12	00054313	0.787	0.551	2.165	0.787	0.472	1.969	95,0	-5,0	-10,0	0.220	CN.43.
MCLNR-25CA-19	00041853	1.378	0.945	3.937	1.260	0.984	3.937	95,0	-6,0	-9,0	1.100	CN..64.
MCFNR-12CA-12	02506169	0.791	0.551	2.165	0.787	0.472	1.969	90,0	-5,0	-10,0	0.220	CN.43.
MCFNR-16CA-12	02506171	0.984	0.709	2.480	0.984	0.630	2.362	90,0	-5,0	-10,0	0.220	CN.43.

Spare Parts

For size	Cantilever clamp	Clamp screw	Insert pin	Insert shim	Setting screw (axial)	Setting screw (radial)
..12..12	 CLM-17	 XNSM-0515	 NLM-43	 -	 EASM-0510F	 SASM-0412
..25..19	 CLM-12	 XNSM-0825	 NLM-68	 CSN-633	 EASM-0816F	 SASM-0820
..16..12	 CLM-17	 XNSM-0515	 NLM-46S	 CSN-433	 EASM-0610F	 SASM-0516

Accessories

For size	Shim screw
..12..12	 -
..25..19	 S-68M
..16..12	 S-46MS

MSKNR and MSSNR – Cartridges for inserts SNGA, SNGN, SNMA, SNMG, SNMM, SNMN and SNMP – Inch

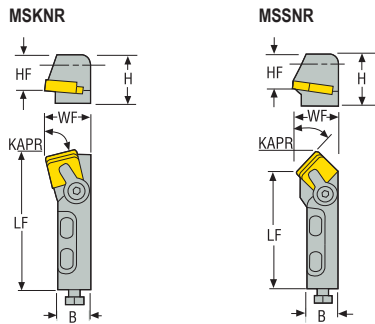

CTWS



- For inserts program, see page(s) 550, 551, 552, 553, 585, 586
- GAMO° = Rake angle, LAMS° = Inclination angle
- CTWS = Insert shape and size
- For cartridge mounting information see page 122
- Right-hand version shown
- Please check availability at www.secotools.com / Seco Online Store

Designation	Item number	H	B	LF	WF	HF	DCINN	KAPR°	GAMO°	LAMS°	Weight	CTWS
		Inch	Inch	Inch	Inch	Inch	Inch				lbs	
MSKNR12CA-12	00041855	0.787	0.551	2.165	0.787	0.472	1.969	75,0	-10,0	-5,0	0.220	SN..43.
MSSNR12CA-12	00041865	0.787	0.551	2.177	0.787	0.472	1.969	45,0	-9,0	-9,0	0.220	SN..43.

Spare Parts

For size	Cantilever clamp	Clamp screw	Insert pin	Setting screw (axial)	Setting screw (radial)
...12	 CLM-6	 XNSM-0515	 NLM-43	 EASM-0510F	 SASM-0412

General ISO Turning Holders
Steadyline®
MDT
Mini-Shaft™
Grooving
Parting-off
X4
Adapters Clamping units
Accessories and Spare parts
Workpiece materials



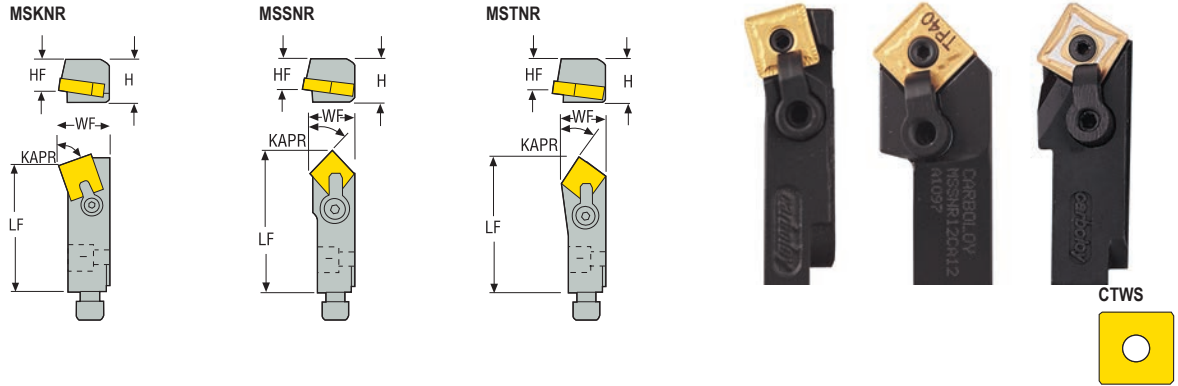

MSKNR, MSSNR and MSTNR – Cartridges for inserts SNGA, SNGN, SNMA, SNMG, SNMM, SNMN and SNMP – Inch



- For inserts program, see page(s) 550, 551, 552, 553, 585, 586
- GAMO° = Rake angle, LAMS° = Inclination angle
- CTWS = Insert shape and size
- For cartridge mounting information see page 122
- Right-hand version shown
- Please check availability at www.secotools.com / Seco Online Store

Designation	Item number	H	B	LF	WF	HF	DCINN	KAPR°	GAMO°	LAMS°	Weight	CTWS
		Inch	Inch	Inch	Inch	Inch	Inch				lbs	
MSKNR-41CX-3	00036450	0.563	0.441	1.969	0.531	0.406	1.500	15,0	-5,0	-8,0	0.220	SN..32
MSSNR-41CX-4	00036422	0.563	0.559	2.306	0.528	0.406	2.000	45,0	-8,0	-8,0	1.540	SN..43
MSTNR-41CX-3	00036470	0.563	0.441	1.969	0.531	0.406	1.500	30,0	-6,0	-10,0	0.220	SN..32
MSTNR-41CX-4	00054341	0.563	0.563	2.386	0.689	0.406	2.000	30,0	-6,0	-10,0	0.220	SN..43

Spare Parts

For size	Cantilever clamp	Clamp screw	Insert pin	Setting screw (axial)	Setting screw (radial)
..-3	 CL-5	 XNS-35	 NL-33	 EAS-253	 SC-605
..-4	CL-6	XNS-35	NL-43	EAS-253	SC-605

General ISO Turning Holders
Steadyline®
MDT
Mini-Shaft™
Grooving
Parting-off
X4
Adapters Clamping units
Accessories and Spare parts
Workpiece materials

MTFNR/L – Cartridges for inserts TNGA, TNGN, TNMA, TNMG, TNMM, TNMN and TNMP – Inch

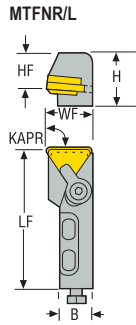

CTWS



- For inserts program, see page(s) 558, 559, 560, 561, 590, 591, 592
- GAMO° = Rake angle, LAMS° = Inclination angle
- CTWS = Insert shape and size
- For cartridge mounting information see page 122
- Right-hand version shown
- Please check availability at www.secotools.com / Seco Online Store

Designation	Item number	H	B	LF	WF	HF	DCINN	KAPR°	GAMO°	LAMS°	Weight	CTWS
		Inch	Inch	Inch	Inch	Inch	Inch				lbs	
MTFNR12CA-16	00041880	0.787	0.551	2.165	0.787	0.472	1.969	90,0	-5,0	-10,0	0.220	TN..32.
MTFNL12CA-16	00041771	0.787	0.551	2.165	0.787	0.472	1.969	90,0	-5,0	-10,0	0.220	TN..32.
MTFNR20CA-22	00041882	1.181	0.709	2.756	0.984	0.787	2.756	90,0	-5,0	-10,0	3.310	TN..43.

Spare Parts

For size	Cantilever clamp	Clamp screw	Insert pin	Insert shim	Setting screw (axial)	Setting screw (radial)
...16	 CLM-17	 XNSM-0515	 NLM-33	 -	 EASM-0510F	 SASM-0412
...22	 CLM-20	 XNSM-0620	 NLM-46	 ITSN-433	 EASM-0610F	 SASM-0516

Accessories

For size	Shim screw
...16	-
...22	S-46M

General ISO Turning Holders
Steadyline®
MDT
Mini-Shaft™
Grooving
Parting-off
X4
Adapters Clamping units
Accessories and Spare parts
Workpiece materials



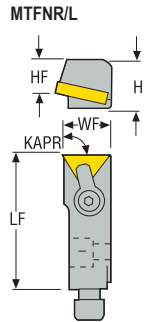

MTFNR/L – Cartridges for inserts TNGA, TNGN, TNMA, TNMG, TNMM, TNMN and TNMP – Inch



- For inserts program, see page(s) 558, 559, 560, 561, 590, 591, 592
- GAMO° = Rake angle, LAMS° = Inclination angle
- CTWS = Insert shape and size
- For cartridge mounting information see page 122
- Right-hand version shown
- Please check availability at www.secotools.com / Seco Online Store

Designation	Item number	H	B	LF	WF	HF	DCINN	KAPR°	GAMO°	LAMS°	Weight	CTWS
		Inch	Inch	Inch	Inch	Inch	Inch				lbs	
MTFNR-41CX-2	00036500	0.563	0.441	1.969	0.531	0.406	1.500	90,0	-5,0	-10,0	0.220	TN..22.
MTFNR-41CX-3	00036502	0.563	0.559	1.969	0.685	0.406	2.000	90,0	-5,0	-8,0	0.220	TN..33.

Spare Parts

For size	Cantilever clamp	Clamp screw	Insert pin	Setting screw (axial)	Setting screw (radial)
..-2	 CL-5	 XNS-35	 NL-23	 EAS-253	 SC-605
..-3	CL-6	XNS-35	NL-33L	EAS-253	SC-605

General ISO Turning Holders
Steadyline®
MDT
Mini-Shaft™
Grooving
Parting-off
X4
Adapters Clamping units
Accessories and Spare parts
Workpiece materials

CT-PLANR/L – Toolholders/cassettes for inserts LNMX – Metric/ Inch

General ISO Turning
Holders

Steadyline®

MDT

Mini-Shaft™

Grooving

Parting-off

X4

Adapters
Clamping units

Accessories and
Spare parts

Workpiece
materials

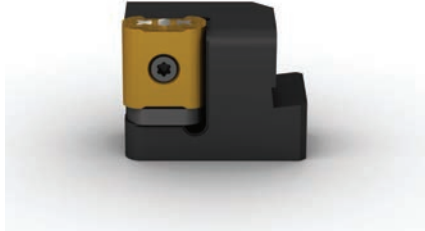

CT-PLANR/L

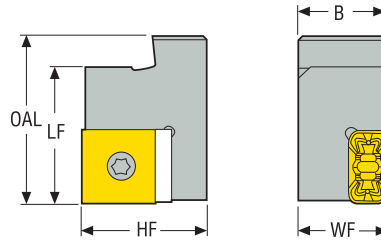

CT-PLANR/L
KAPR = 90,0 °

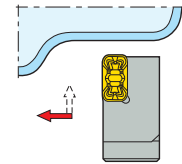

CTWS



- For inserts program, see page(s) 542
- CTWS = Insert shape and size
- CT-PLANR/L 3223-19 are updated version of R/L175.32-3223-19. They have better manufacturing tolerances. R/ L175.32-3223-19 will be deleted from the program in future.
- Right-hand version shown
- Please check availability at www.secotools.com / Seco Online Store

Designation	Item number	HF	WF	B	LF	OAL	Weight	CTWS
		mm <i>Inch</i>	mm <i>Inch</i>	mm <i>Inch</i>	mm <i>Inch</i>	mm <i>Inch</i>	kg <i>lbs</i>	
CT-PLANR3223-19	02809911	32,0 1.260	23,0 0.906	23 0.890	35 1.378	42 1.661	0,2 0.440	LN..1919..
CT-PLANL3223-19	02809912	32,0 1.260	23,0 0.906	23 0.890	35 1.378	42 1.661	0,2 0.440	LN..1919..

Spare Parts

For size	Insert key	Insert screw	Insert shim	Shim screw
...-19	 T15P-2	 MN1515SL-T15P	 LN190450	 174.10-650.9-T07P

Accessories

For size	Insert clamping torque	Replacement blade	Shim key	Torque key
...-19	 3.0NM	 T00-15P	 T07P-2	 T00-15P30

CT-PLANR/L – Toolholders/cassettes for inserts LNMX – Metric / Inch

CT-PLANR/L
KAPR = 90,0°



R/L175.32

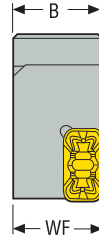
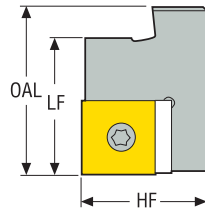





CTWS







- For inserts program, see page(s) 542
- CTWS = Insert shape and size
- CT-PLANR/L 3223-19 are updated version of R/L175.32-3223-19. They have better manufacturing tolerances. R/L175.32-3223-19 will be deleted from the program in future.
- Right-hand version shown
- Please check availability at www.secotools.com / Seco Online Store

Designation	Item number	HF	WF	B	LF	OAL	Weight	CTWS
		mm Inch	mm Inch	mm Inch	mm Inch	mm Inch	kg lbs	
R175.32-3223-30	00013035	32,0 1.260	23,0 0.906	23 0.890	35 1.378	42 1.661	0,2 0.440	LN..3019..
L175.32-3223-30	00013036	32,0 1.260	23,0 0.906	23 0.890	35 1.378	42 1.661	0,2 0.440	LN..3019..

Spare Parts

For size	Insert key	Insert screw	Insert shim	Shim screw
...-30	 T15P-2	 MN1515SL-T15P	 LN300450	 174.10-650.9-T07P

Accessories

For size	Insert clamping torque	Replacement blade	Shim key	Torque key
...-30	 3.0NM	 T00-15P	 T07P-2	 T00-15P30

General ISO Turning
Holders

Steadyline®

MDT

Mini-Shaft™

Grooving

Parting-off

X4

Adapters
Clamping units

Accessories and
Spare parts

Workpiece
materials

CT-PLFNR/L – Toolholders/cassettes for inserts LNMX – Metric / Inch

General ISO Turning
Holders

Steadyline®

MDT

Mini-Shaft™

Grooving

Parting-off

X4

Adapters
Clamping units

Accessories and
Spare parts

Workpiece
materials

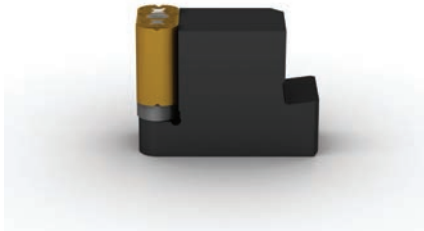

CTWS



CT-PLFNR/L

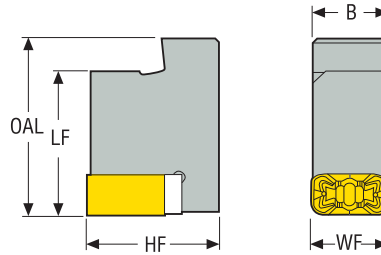

CT-PLFNR/L
KAPR = 90,0 °

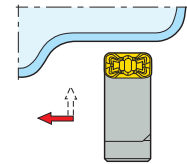

- For inserts program, see page(s) 542
- CTWS = Insert shape and size
- Right-hand version shown
- Please check availability at www.secotools.com / Seco Online Store

Designation	Item number	HF	WF	B	LF	OAL	Weight	CTWS
		mm Inch	mm Inch	mm Inch	mm Inch	mm Inch		
CT-PLFNR3219-19	02809915	32,0 1.260	19,0 0.748	18 0.719	35 1.378	43 1.693	0,2 0.440	LN..1919..
CT-PLFNL3219-19	02809910	32,0 1.260	19,0 0.748	18 0.719	35 1.378	43 1.693	0,2 0.440	LN..1919..

Spare Parts

For size	Insert key	Insert screw	Insert shim	Shim screw
...-19	 T15P-2	 MN1515SL-T15P	 LN190450	 174.10-650.9-T07P

Accessories

For size	Insert clamping torque	Replacement blade	Shim key	Torque key
...-19	 3.0NM	 T00-15P	 T07P-2	 T00-15P30



General Turning Inserts

Anything is possible when it comes to our broad selection of general turning grades and chipbreakers. Supporting inserts of different shapes, sizes and thicknesses, we developed each of these solutions with the same goal in mind: to boost the productivity and tool life in your turning applications. Covering all material groups, this comprehensive range allows you to achieve your goals in terms of material removal rates, tool life and surface finish.

- Duratomic® is an exclusive insert technology that brings an exceptional combination of wear resistance and edge toughness to a wide variety of Seco grades.
- Wide range of inserts grades to cover all material groups.
- Coated, uncoated and cermet grades.

CCGT, CCGX, CCMT

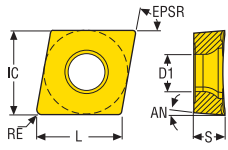

CCGT, CCGX
Tolerances:
IC = $\pm 0,025/0,001$
S = $\pm 0,05/0,002$
RE = ($\geq 0,2/0,008$) = $\pm 0,1/0,0039$
RE = ($\leq 0,1/0,004$) = $\pm 0,025/0,001$

CCMT
Tolerances: Size:
IC = $\pm 0,05/0,002$ 06-09/2-3
IC = $\pm 0,08/0,0031$ 12/4
IC = $\pm 0,10/0,0039$ 16/5
IC = $\pm 0,13/0,0051$ 25/8
S = $\pm 0,05/0,002$ 06-09/2-3
S = $\pm 0,13/0,0051$ 12-25/4-8
RE = $\pm 0,1/0,0039$

* Right-hand version shown
Please check availability at
www.secotools.com / Seco Online Store

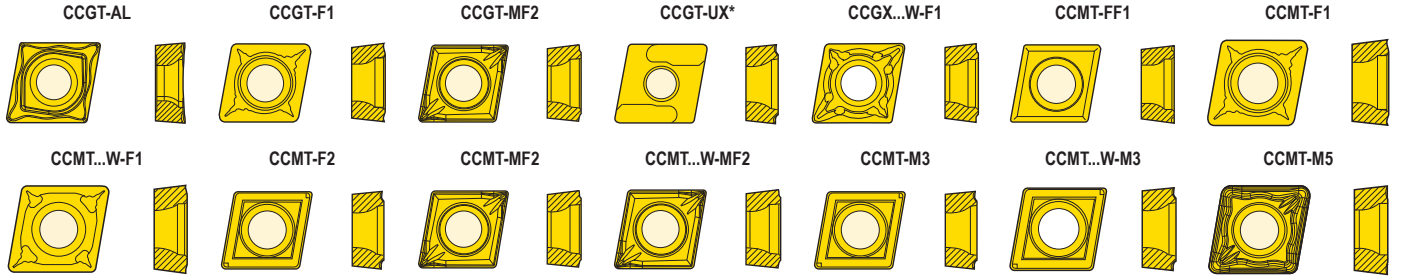

Designation	RE	IC	L	S	D1	EPSR°	AN°	Cemented Carbide and Cermet Grades																			
								Coated											Uncoated		Cermet						
								TP0501	TP1501	TP2501	TP3501	TP25	TP40	TM1501	TM2501	TM3501	TK0501	TK1501	TS2000	TS2050	TS2500	TH1000	TH1500	CP200	CP500	CP600	HX
CCGT0602005-F1 CCGT21.50.0-F1	0,05 0,002	6,35 0,250	6,5 0,256	2,38 0,094	2,9 0,114	80,0	7,0																				
CCGT060201-F1 CCGT21.50-F1	0,1 0,004	6,35 0,250	6,5 0,256	2,38 0,094	2,9 0,114	80,0	7,0																				
CCGT060201-MF2 CCGT21.50-MF2	0,1 0,004	6,35 0,250	6,5 0,256	2,38 0,094	2,9 0,114	80,0	7,0																				
CCGT060202F-AL CCGT21.50F-AL	0,2 0,008	6,35 0,250	6,5 0,256	2,38 0,094	2,8 0,110	80,0	7,0																				
CCGT060202-MF2 CCGT21.50.5-MF2	0,2 0,008	6,35 0,250	6,45 0,254	2,38 0,094	2,9 0,114	80,0	7,0																				
CCGX060202W-F1 CCGX21.50.5W-F1	0,2 0,008	6,35 0,250	6,5 0,256	2,38 0,094	2,9 0,114	80,0	7,0																				
CCMT060202-F1 CCMT21.50.5-F1	0,2 0,008	6,35 0,250	6,5 0,256	2,38 0,094	2,9 0,114	80,0	7,0																				
CCMT060202-F2 CCMT21.50.5-F2	0,2 0,008	6,35 0,250	6,5 0,256	2,38 0,094	2,9 0,114	80,0	7,0																				
CCMT060202-FF1 CCMT21.50.5-FF1	0,2 0,008	6,35 0,250	6,5 0,256	2,38 0,094	2,9 0,114	80,0	7,0																				
CCMT060202-M3 CCMT21.50.5-M3	0,2 0,008	6,35 0,250	6,5 0,256	2,38 0,094	2,9 0,114	80,0	7,0																				
CCMT060202-MF2 CCMT21.50.5-MF2	0,2 0,008	6,35 0,250	6,5 0,256	2,38 0,094	2,9 0,114	80,0	7,0																				
CCGT060204F-AL CCGT21.51F-AL	0,4 0,016	6,35 0,250	6,5 0,256	2,38 0,094	2,8 0,110	80,0	7,0																				
CCGT060204-F1 CCGT21.51-F1	0,4 0,016	6,35 0,250	6,5 0,256	2,38 0,094	2,9 0,114	80,0	7,0																				
CCGT060204-MF2 CCGT21.51-MF2	0,4 0,016	6,35 0,250	6,5 0,256	2,38 0,094	2,9 0,114	80,0	7,0																				
CCGT060204R-UX CCGT21.51R-UX	0,4 0,016	6,35 0,250	6,5 0,256	2,38 0,094	2,8 0,110	80,0	7,0																				
CCGT060204L-UX CCGT21.51L-UX	0,4 0,016	6,35 0,250	6,5 0,256	2,38 0,094	2,8 0,110	80,0	7,0																				
CCMT060204-F1 CCMT21.51-F1	0,4 0,016	6,35 0,250	6,5 0,256	2,38 0,094	2,9 0,114	80,0	7,0																				
CCMT060204W-F1 CCMT21.51W-F1	0,4 0,016	6,35 0,250	6,5 0,256	2,38 0,094	2,9 0,114	80,0	7,0																				
CCMT060204-F2 CCMT21.51-F2	0,4 0,016	6,35 0,250	6,5 0,256	2,38 0,094	2,9 0,114	80,0	7,0																				
CCMT060204-FF1 CCMT21.51-FF1	0,4 0,016	6,35 0,250	6,5 0,256	2,38 0,094	2,9 0,114	80,0	7,0																				

Designation	RE	IC	L	S	D1	EPR ^o	AN ^o	Cemented Carbide and Cermet Grades																			
								Coated											Uncoated				Cermet				
								TP0501	TP1501	TP2501	TP3501	TP25	TP40	TM1501	TM2501	TM3501	TK0501	TK1501	TS2000	TS2050	TS2500	TH1000	TH1500	CP200	CP500	CP600	HX
mm Inch	mm Inch	mm Inch	mm Inch	mm Inch																							
CCMT060204-M3 CCMT21.51-M3	0,4 0.016	6,35 0.250	6,5 0.256	2,38 0.094	2,9 0.114	80,0	7,0		■	■	■	■	■														
CCMT060204-MF2 CCMT21.51-MF2	0,4 0.016	6,35 0.250	6,5 0.256	2,38 0.094	2,9 0.114	80,0	7,0	■	■	■	■								■	■					■	■	
CCMT060204W-MF2 CCMT21.51W-MF2	0,4 0.016	6,35 0.250	6,5 0.256	2,38 0.094	2,9 0.114	80,0	7,0					■							■								
CCMT060208-F1 CCMT21.52-F1	0,8 0.031	6,35 0.250	6,5 0.256	2,38 0.094	2,9 0.114	80,0	7,0			■	■								■						■		
CCMT060208-F2 CCMT21.52-F2	0,8 0.031	6,35 0.250	6,5 0.256	2,38 0.094	2,9 0.114	80,0	7,0					■								■							
CCMT060208-M3 CCMT21.52-M3	0,8 0.031	6,35 0.250	6,5 0.256	2,38 0.094	2,9 0.114	80,0	7,0			■	■	■															
CCMT060208-MF2 CCMT21.52-MF2	0,8 0.031	6,35 0.250	6,5 0.256	2,38 0.094	2,9 0.114	80,0	7,0	■	■	■	■								■								
CCMT090304-F2 CCMT321-F2	0,4 0.016	9,525 0.375	9,7 0.382	3,18 0.125	4,5 0.177	80,0	7,0													■							
CCMT090304-M3 CCMT321-M3	0,4 0.016	9,525 0.375	9,67 0.381	3,18 0.125	4,5 0.177	80,0	7,0				■																
CCGT09T3005-F1 CCGT32.50.0-F1	0,05 0.002	9,525 0.375	9,67 0.381	3,97 0.156	4,5 0.177	80,0	7,0																				
CCGT09T301-F1 CCGT32.50-F1	0,1 0.004	9,525 0.375	9,7 0.382	3,97 0.156	4,5 0.177	80,0	7,0																				
CCGT09T302F-AL CCGT32.50.5F-AL	0,2 0.008	9,525 0.375	9,7 0.382	3,97 0.156	4,4 0.173	80,0	7,0																				
CCGT09T302-F1 CCGT32.50.5-F1	0,2 0.008	9,525 0.375	9,67 0.381	3,97 0.156	4,5 0.177	80,0	7,0																				
CCGX09T302W-F1 CCGX32.50.5W-F1	0,2 0.008	9,525 0.375	9,7 0.382	3,97 0.156	4,5 0.177	80,0	7,0				■																
CCMT09T302-F1 CCMT32.50.5-F1	0,2 0.008	9,525 0.375	9,7 0.382	3,97 0.156	4,5 0.177	80,0	7,0		■	■	■														■	■	
CCMT09T302-F2 CCMT32.50.5-F2	0,2 0.008	9,525 0.375	9,7 0.382	3,97 0.156	4,5 0.177	80,0	7,0																				
CCMT09T302-M3 CCMT32.50.5-M3	0,2 0.008	9,525 0.375	9,67 0.381	3,97 0.156	4,5 0.177	80,0	7,0		■	■																	
CCMT09T302-MF2 CCMT32.50.5-MF2	0,2 0.008	9,525 0.375	9,7 0.382	3,97 0.156	4,5 0.177	80,0	7,0				■															■	
CCGT09T304F-AL CCGT32.51F-AL	0,4 0.016	9,525 0.375	9,7 0.382	3,97 0.156	4,4 0.173	80,0	7,0																				
CCGT09T304-F1 CCGT32.51-F1	0,4 0.016	9,525 0.375	9,7 0.382	3,97 0.156	4,5 0.177	80,0	7,0																			■	
CCGT09T304-MF2 CCGT32.51-MF2	0,4 0.016	9,525 0.375	9,7 0.382	3,97 0.156	4,5 0.177	80,0	7,0																				
CCGT09T304R-UX CCGT32.51R-UX	0,4 0.016	9,525 0.375	9,7 0.382	3,97 0.156	4,4 0.173	80,0	7,0																				
CCGT09T304L-UX CCGT32.51L-UX	0,4 0.016	9,525 0.375	9,7 0.382	3,97 0.156	4,4 0.173	80,0	7,0																				
CCMT09T304-F1 CCMT32.51-F1	0,4 0.016	9,525 0.375	9,7 0.382	3,97 0.156	4,5 0.177	80,0	7,0		■	■	■	■	■	■	■	■	■	■	■	■	■	■	■	■	■	■	■
CCMT09T304W-F1 CCMT32.51W-F1	0,4 0.016	9,525 0.375	9,7 0.382	3,97 0.156	4,5 0.177	80,0	7,0		■	■																■	
CCMT09T304-F2 CCMT32.51-F2	0,4 0.016	9,525 0.375	9,7 0.382	3,97 0.156	4,5 0.177	80,0	7,0																				
CCMT09T304-FF1 CCMT32.51-FF1	0,4 0.016	9,525 0.375	9,7 0.382	3,97 0.156	4,5 0.177	80,0	7,0				■																
CCMT09T304-M3 CCMT32.51-M3	0,4 0.016	9,525 0.375	9,7 0.382	3,97 0.156	4,5 0.177	80,0	7,0		■	■	■	■	■	■	■	■	■	■	■	■	■	■	■	■	■	■	■
CCMT09T304-M5 CCMT32.51-M5	0,4 0.016	9,525 0.375	9,7 0.382	3,97 0.156	4,5 0.177	80,0	7,0	■	■	■	■																
CCMT09T304-MF2 CCMT32.51-MF2	0,4 0.016	9,525 0.375	9,7 0.382	3,97 0.156	4,5 0.177	80,0	7,0		■	■	■														■	■	

General ISO Turning Inserts

Steadyline

MDT

Mini-Shaft™

Grooving

Parting-off

X4

Adapters Clamping units

Accessories and Spare parts

Workpiece materials

General ISO Turning Inserts	Designation	RE	IC	L	S	D1	EPSR°	AN°	Cemented Carbide and Cermet Grades																			
									Coated															Uncoated		Cermet		
									TP0601	TP1601	TP2601	TP3601	TP25	TP40	TM1501	TM2501	TM3501	TK0501	TK1501	TS2000	TS2050	TS2500	TH1000	TH1500	CP200	CP500	CP600	HX
mm Inch	mm Inch	mm Inch	mm Inch	mm Inch																								
General ISO Turning Inserts	CCMT09T304W-MF2 CCMT32.51W-MF2	0,4 0.016	9,525 0.375	9,7 0.382	3,97 0.156	4,5 0.177	80,0	7,0	■	■	■							■										
	CCGT09T308F-AL CCGT32.52F-AL	0,8 0.031	9,525 0.375	9,7 0.382	3,97 0.156	4,4 0.173	80,0	7,0														■						
Steadyline®	CCMT09T308-F1 CCMT32.52-F1	0,8 0.031	9,525 0.375	9,7 0.382	3,97 0.156	4,5 0.177	80,0	7,0	■	■	■	■	■	■	■	■	■	■							■			
	CCMT09T308W-F1 CCMT32.52W-F1	0,8 0.031	9,525 0.375	9,7 0.382	3,97 0.156	4,5 0.177	80,0	7,0	■	■	■													■	■			
MDT	CCMT09T308-F2 CCMT32.52-F2	0,8 0.031	9,525 0.375	9,7 0.382	3,97 0.156	4,5 0.177	80,0	7,0					■							■								
	CCMT09T308-FF1 CCMT32.52-FF1	0,8 0.031	9,525 0.375	9,67 0.381	3,97 0.156	4,5 0.177	80,0	7,0							■													
Mini-Shaft™	CCMT09T308-M3 CCMT32.52-M3	0,8 0.031	9,525 0.375	9,7 0.382	3,97 0.156	4,5 0.177	80,0	7,0	■	■	■	■		■	■	■	■											
	CCMT09T308W-M3 CCMT32.52W-M3	0,8 0.031	9,525 0.375	9,67 0.381	3,97 0.156	4,5 0.177	80,0	7,0	■																			
Grooving	CCMT09T308-M5 CCMT32.52-M5	0,8 0.031	9,525 0.375	9,7 0.382	3,97 0.156	4,5 0.177	80,0	7,0	■	■	■	■		■														
	CCMT09T308-MF2 CCMT32.52-MF2	0,8 0.031	9,525 0.375	9,7 0.382	3,97 0.156	4,5 0.177	80,0	7,0	■	■	■	■		■	■	■		■						■				
Parting-off	CCMT09T308W-MF2 CCMT32.52W-MF2	0,8 0.031	9,525 0.375	9,7 0.382	3,97 0.156	4,5 0.177	80,0	7,0	■	■				■				■							■			
	CCMT09T312-M3 CCMT32.53-M3	1,2 0.047	9,525 0.375	9,7 0.382	3,97 0.156	4,5 0.177	80,0	7,0	■	■	■	■																
Adapters Clamping units	CCGT120404F-AL CCGT431F-AL	0,4 0.016	12,7 0.500	12,9 0.508	4,76 0.187	5,5 0.217	80,0	7,0			■	■										■						
	CCMT120404-F1 CCMT431-F1	0,4 0.016	12,7 0.500	12,9 0.508	4,76 0.187	5,6 0.220	80,0	7,0			■	■						■										
X4	CCMT120404W-F1 CCMT431W-F1	0,4 0.016	12,7 0.500	12,9 0.508	4,76 0.187	5,6 0.220	80,0	7,0			■																	
	CCMT120404-F2 CCMT431-F2	0,4 0.016	12,7 0.500	12,9 0.508	4,76 0.187	5,6 0.220	80,0	7,0														■						
Accessories and Spare parts	CCMT120404-M3 CCMT431-M3	0,4 0.016	12,7 0.500	12,9 0.508	4,76 0.187	5,6 0.220	80,0	7,0	■	■	■	■																
	CCGT120408F-AL CCGT432F-AL	0,8 0.031	12,7 0.500	12,9 0.508	4,76 0.187	5,5 0.217	80,0	7,0															■					
Workpiece materials	CCGT120408R-UX CCGT432R-UX	0,8 0.031	12,7 0.500	12,9 0.508	4,76 0.187	5,5 0.217	80,0	7,0																				
	CCGT120408L-UX CCGT432L-UX	0,8 0.031	12,7 0.500	12,9 0.508	4,76 0.187	5,5 0.217	80,0	7,0																				
Workpiece materials	CCMT120408-F1 CCMT432-F1	0,8 0.031	12,7 0.500	12,9 0.508	4,76 0.187	5,6 0.220	80,0	7,0			■	■							■									
	CCMT120408W-F1 CCMT432W-F1	0,8 0.031	12,7 0.500	12,9 0.508	4,76 0.187	5,6 0.220	80,0	7,0			■																	
Workpiece materials	CCMT120408-F2 CCMT432-F2	0,8 0.031	12,7 0.500	12,9 0.508	4,76 0.187	5,6 0.220	80,0	7,0						■							■							
	CCMT120408-M3 CCMT432-M3	0,8 0.031	12,7 0.500	12,9 0.508	4,76 0.187	5,6 0.220	80,0	7,0	■	■	■	■		■	■	■	■											
Workpiece materials	CCMT120408-M5 CCMT432-M5	0,8 0.031	12,7 0.500	12,9 0.508	4,76 0.187	5,6 0.220	80,0	7,0	■	■	■	■		■														
	CCMT120408-MF2 CCMT432-MF2	0,8 0.031	12,7 0.500	12,9 0.508	4,76 0.187	5,6 0.220	80,0	7,0	■	■	■			■														
Workpiece materials	CCMT120412-F1 CCMT433-F1	1,2 0.047	12,7 0.500	12,9 0.508	4,76 0.187	5,6 0.220	80,0	7,0			■																	
	CCMT120412-M3 CCMT433-M3	1,2 0.047	12,7 0.500	12,9 0.508	4,76 0.187	5,6 0.220	80,0	7,0	■	■	■	■																
Workpiece materials	CCMT120412-M5 CCMT433-M5	1,2 0.047	12,7 0.500	12,9 0.508	4,76 0.187	5,6 0.220	80,0	7,0	■	■	■	■		■														
	CCMT160508-M3 CCMT53.52-M3	0,8 0.031	15,875 0.625	16,12 0.635	5,56 0.219	5,6 0.220	80,0	7,0			■																	

Designation	RE	IC	L	S	D1	EPSR°	AN°	Cemented Carbide and Cermet Grades																			
								Coated										Uncoated				Cermet					
								TP0501	TP1501	TP2501	TP3501	TP25	TP40	TM1501	TM2501	TM3501	TK0501	TK1501	TS2000	TS2050	TS2500	TH1000	TH1500	CP200	CP500	CP600	HX
mm Inch	mm Inch	mm Inch	mm Inch	mm Inch																							
CCMT160508-M5 CCMT53.52-M5	0.8 0.031	15.875 0.625	16.1 0.634	5.56 0.219	5.6 0.220	80,0	7,0			■	■																
CCMT160512-M3 CCMT53.53-M3	1.2 0.047	15.875 0.625	16.12 0.635	5.56 0.219	5.6 0.220	80,0	7,0						■														
CCMT160512-M5 CCMT53.53-M5	1.2 0.047	15.875 0.625	16.1 0.634	5.56 0.219	5.6 0.220	80,0	7,0			■	■																
CCMT160516-M5 CCMT53.54-M5	1.6 0.063	15.875 0.625	16.1 0.634	5.56 0.219	5.6 0.220	80,0	7,0			■	■																

General ISO Turning Inserts

Steadyline®

MDT

Mini-Shaft™

Grooving

Parting-off

X4

Adapters
Clamping units

Accessories and
Spare parts

Workpiece
materials

CDCB

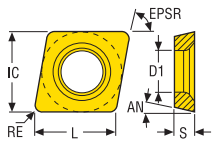

Tolerances:
 IC = $\pm 0,025/0,001$
 S = $\pm 0,025/0,001$
 RE = $\pm 0,025/0,001$

Please check availability at
www.secotools.com / Seco Online Store

General ISO Turning
Inserts

Steadyline®

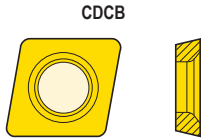

MDT

Designation	RE	IC	L	S	D1	EPSR°	AN°	Cemented Carbide and Cermet Grades																									
								Coated												Uncoated		Cermet											
	<i>mm</i>	<i>mm</i>	<i>mm</i>	<i>mm</i>	<i>mm</i>			TP0501	TP1501	TP2501	TP3501	TP25	TP40	TM1501	TM2501	TM3501	TK0501	TK1501	TS2000	TS2050	TS2500	TH1000	TH1500	CP200	CP500	CF600	HX	KX	883	890	TP1030	TP1020	
CDCB04T0005 CDCB1.21.20	0,05 0.002	3,969 0.156	4,03 0.159	0,966 0.038	2,04 0.080	80,0	15,0																										
CDCB04T002 CDCB1.21.20.5	0,2 0.008	3,969 0.156	4,03 0.159	0,966 0.038	2,04 0.080	80,0	15,0															■			■								
CDCB04T004 CDCB1.21.21	0,4 0.016	3,969 0.156	4,03 0.159	0,966 0.038	2,04 0.080	80,0	15,0															■			■								

Mini-Shaft™

Grooving

Parting-off

X4

Adapters
Clamping units

Accessories and
Spare parts

Workpiece
materials

Please check availability at
www.secotools.com / Seco Online Store

CNGG
Tolerances:
IC = ±0,025/0.001
S = ±0,13/0.005
RE = ±0,1/0.004

CNMA, CNMG, CNMM
Tolerances: Size:
IC = ±0,05/0.002 09/3
IC = ±0,08/0.003 12/4
IC = ±0,10/0.004 16-19/5-6
IC = ±0,13/0.005 25/8
S = ±0,13/0.005
RE = ±0,1/0.004

CNGG, CNMA, CNMG, CNMM

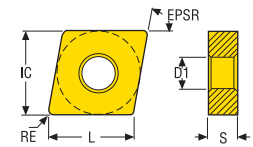

Designation	RE	IC	L	S	D1	EPSR°	AN°	Cemented Carbide and Cermet Grades																											
								Coated							Uncoated			Cermet																	
	mm	mm	mm	mm	mm			TP0501	TP1501	TP2501	TP3501	TP25	TP40	TM1501	TM2501	TM3501	TK0501	TK1501	TS2000	TS2050	TS2500	TH1000	TH1500	CP200	CP500	CP600	HX	KX	883	890	TP1030	TP1020			
	Inch	Inch	Inch	Inch	Inch																														
CNMG090304-M3 CNMG321-M3	0,4 0.016	9,525 0.375	9,7 0.382	3,18 0.125	3,81 0.150	80,0	0,0		■						■																				
CNMG090308-M3 CNMG322-M3	0,8 0.031	9,525 0.375	9,7 0.382	3,18 0.125	3,81 0.150	80,0	0,0		■						■																				
CNGG120401-MF1 CNGP430-MF1	0,1 0.004	12,7 0.500	12,9 0.508	4,76 0.187	5,15 0.203	80,0	0,0													■														■	
CNGG120402-M1 CNGP430.5-M1	0,2 0.008	12,7 0.500	12,9 0.508	4,76 0.187	5,15 0.203	80,0	0,0															■												■	
CNGG120402-MF1 CNGP430.5-MF1	0,2 0.008	12,7 0.500	12,9 0.508	4,76 0.187	5,15 0.203	80,0	0,0														■													■	
CNMG120402-FF2 CNMG430.5-FF2	0,2 0.008	12,7 0.500	12,9 0.508	4,76 0.187	5,15 0.203	80,0	0,0		■																									■	
CNGG120404-M1 CNGP431F-M1	0,4 0.016	12,7 0.500	12,9 0.508	4,76 0.187	5,15 0.203	80,0	0,0																											■	
CNGG120404-MF1 CNGP431-MF1	0,4 0.016	12,7 0.500	12,9 0.508	4,76 0.187	5,15 0.203	80,0	0,0														■													■	
CNMA120404 CNMA431	0,4 0.016	12,7 0.500	12,9 0.508	4,76 0.187	5,15 0.203	80,0	0,0																												■
CNMG120404-FF1 CNMG431-FF1	0,4 0.016	12,7 0.500	12,9 0.508	4,76 0.187	5,15 0.203	80,0	0,0			■	■																								■

General ISO Turning
Inserts

Steadyline®

MDT

Mini-Shaft™

Grooving

Parting-off

X4

Adapters
Clamping units

Accessories and
Spare parts

Workpiece
materials

Designation	RE	IC	L	S	D1	EPR [®]	AN [°]	Cemented Carbide and Cermet Grades																					
								Coated											Uncoated				Cermet						
								TP0501	TP1501	TP2501	TP3501	TP25	TP40	TM1501	TM2501	TM3501	TK0501	TK1501	TS2000	TS2050	TS2500	TH1000	TH1500	CP200	CP500	CP600	HX	KX	883
mm Inch	mm Inch	mm Inch	mm Inch	mm Inch																									
CNMG120408W-MF2 CNMG432W-MF2	0,8 0.031	12,7 0.500	12,9 0.508	4,76 0.187	5,15 0.203	80,0	0,0	■	■	■	■																■		
CNMG120408-MF3 CNMG432-MF3	0,8 0.031	12,7 0.500	12,9 0.508	4,76 0.187	5,15 0.203	80,0	0,0				■	■	■																
CNMG120408-MF4 CNMG432-MF4	0,8 0.031	12,7 0.500	12,9 0.508	4,76 0.187	5,15 0.203	80,0	0,0					■	■	■						■									
CNMG120408W-MF4 CNMG432W-MF4	0,8 0.031	12,7 0.500	12,9 0.508	4,76 0.187	5,15 0.203	80,0	0,0					■	■	■															
CNMG120408-MF5 CNMG432-MF5	0,8 0.031	12,7 0.500	12,9 0.508	4,76 0.187	5,15 0.203	80,0	0,0	■	■	■																			
CNMG120408W-MF5 CNMG432W-MF5	0,8 0.031	12,7 0.500	12,9 0.508	4,76 0.187	5,15 0.203	80,0	0,0																						
CNMG120408-MR3 CNMG432-MR3	0,8 0.031	12,7 0.500	12,9 0.508	4,76 0.187	5,15 0.203	80,0	0,0													■	■						■		
CNMG120408-MR4 CNMG432-MR4	0,8 0.031	12,7 0.500	12,9 0.508	4,76 0.187	5,15 0.203	80,0	0,0																				■		
CNMG120408-MR6 CNMG432-MR6	0,8 0.031	12,7 0.500	12,9 0.508	4,76 0.187	5,15 0.203	80,0	0,0		■	■																			
CNMG120408-MR7 CNMG432-MR7	0,8 0.031	12,7 0.500	12,9 0.508	4,76 0.187	5,15 0.203	80,0	0,0		■	■	■		■																
CNMM120408-R4 CNMM432-R4	0,8 0.031	12,7 0.500	12,9 0.508	4,76 0.187	5,15 0.203	80,0	0,0		■	■	■	■																	
CNMM120408-R6 CNMM432-R6	0,8 0.031	12,7 0.500	12,9 0.508	4,76 0.187	5,15 0.203	80,0	0,0				■	■																	
CNMA120412 CNMA433	1,2 0.047	12,7 0.500	12,9 0.508	4,76 0.187	5,15 0.203	80,0	0,0																						
CNMA120412-MR9 CNMA433-MR9	1,2 0.047	12,7 0.500	12,9 0.508	4,76 0.187	5,15 0.203	80,0	0,0																						
CNMG120412-M1 CNMP433-M1	1,2 0.047	12,7 0.500	12,9 0.508	4,76 0.187	5,15 0.203	80,0	0,0																					■	
CNMG120412-M3 CNMG433-M3	1,2 0.047	12,7 0.500	12,9 0.508	4,76 0.187	5,15 0.203	80,0	0,0	■	■	■	■	■	■	■	■	■				■									
CNMG120412W-M3 CNMG433W-M3	1,2 0.047	12,7 0.500	12,9 0.508	4,76 0.187	5,15 0.203	80,0	0,0	■	■	■																			
CNMG120412-M4 CNMG433-M4	1,2 0.047	12,7 0.500	12,9 0.508	4,76 0.187	5,15 0.203	80,0	0,0																						
CNMG120412-M5 CNMG433-M5	1,2 0.047	12,7 0.500	12,9 0.508	4,76 0.187	5,15 0.203	80,0	0,0	■	■	■	■	■	■	■	■														
CNMG120412-M6 CNMG433-M6	1,2 0.047	12,7 0.500	12,9 0.508	4,76 0.187	5,15 0.203	80,0	0,0	■	■	■	■																		
CNMG120412W-M6 CNMG433W-M6	1,2 0.047	12,7 0.500	12,9 0.508	4,76 0.187	5,15 0.203	80,0	0,0		■	■	■																		
CNMG120412W-MF1 CNMG433W-MF1	1,2 0.047	12,7 0.500	12,9 0.508	4,76 0.187	5,15 0.203	80,0	0,0														■								
CNMG120412-MF2 CNMG433-MF2	1,2 0.047	12,7 0.500	12,9 0.508	4,76 0.187	5,15 0.203	80,0	0,0	■	■	■																			
CNMG120412W-MF2 CNMG433W-MF2	1,2 0.047	12,7 0.500	12,9 0.508	4,76 0.187	5,15 0.203	80,0	0,0	■																					
CNMG120412-MF3 CNMG433-MF3	1,2 0.047	12,7 0.500	12,9 0.508	4,76 0.187	5,15 0.203	80,0	0,0																						
CNMG120412-MF4 CNMG433-MF4	1,2 0.047	12,7 0.500	12,9 0.508	4,76 0.187	5,15 0.203	80,0	0,0																						
CNMG120412W-MF4 CNMG433W-MF4	1,2 0.047	12,7 0.500	12,9 0.508	4,76 0.187	5,15 0.203	80,0	0,0																						
CNMG120412-MF5 CNMG433-MF5	1,2 0.047	12,7 0.500	12,9 0.508	4,76 0.187	5,15 0.203	80,0	0,0	■	■	■																			
CNMG120412-MR3 CNMG433-MR3	1,2 0.047	12,7 0.500	12,9 0.508	4,76 0.187	5,15 0.203	80,0	0,0																						
CNMG120412-MR4 CNMG433-MR4	1,2 0.047	12,7 0.500	12,9 0.508	4,76 0.187	5,15 0.203	80,0	0,0																						

General ISO Turning Inserts
Steadyline[®]
MDT
Mini-Shaft[™]
Grooving
Parting-off
X4
Adapters Clamping units
Accessories and Spare parts
Workpiece materials

General ISO Turning Inserts	Designation	Cemented Carbide and Cermet Grades						Coated												Uncoated				Cermet									
		RE	IC	L	S	D1	EPSR°	AN°	TP0501	TP1501	TP2501	TP3501	TP25	TP40	TM1501	TM2501	TM3501	TK0501	TK1501	TS2000	TS2050	TS2500	TH1000	TH1500	CP200	CP500	CP600	HX	KX	883	890	TP1030	TP1020
		mm Inch	mm Inch	mm Inch	mm Inch	mm Inch																											
General ISO Turning Inserts	CNMG120412-MR6 CNMG433-MR6	1,2 0.047	12,7 0.500	12,9 0.508	4,76 0.187	5,15 0.203	80,0	0,0	■	■																							
	CNMG120412-MR7 CNMG433-MR7	1,2 0.047	12,7 0.500	12,9 0.508	4,76 0.187	5,15 0.203	80,0	0,0	■	■	■	■	■	■	■			■	■														
Steadyline®	CNMM120412-R4 CNMM433-R4	1,2 0.047	12,7 0.500	12,9 0.508	4,76 0.187	5,15 0.203	80,0	0,0	■	■	■	■		■																			
	CNMM120412W-R4 CNMM433W-R4	1,2 0.047	12,7 0.500	12,9 0.508	4,76 0.187	5,15 0.203	80,0	0,0	■	■																							
MDT	CNMM120412-R6 CNMM433-R6	1,2 0.047	12,7 0.500	12,9 0.508	4,76 0.187	5,15 0.203	80,0	0,0				■																					
	CNMM120412-R8 CNMM433-R8	1,2 0.047	12,7 0.500	12,9 0.508	4,76 0.187	5,15 0.203	80,0	0,0					■																				
Mini-Shaft™	CNMG120416-M3 CNMG434-M3	1,6 0.063	12,7 0.500	12,9 0.508	4,76 0.187	5,15 0.203	80,0	0,0	■	■																							
	CNMG120416-M5 CNMG434-M5	1,6 0.063	12,7 0.500	12,9 0.508	4,76 0.187	5,15 0.203	80,0	0,0	■	■	■	■	■	■		■																	
Grooving	CNMG120416-M6 CNMG434-M6	1,6 0.063	12,7 0.500	12,9 0.508	4,76 0.187	5,15 0.203	80,0	0,0	■	■	■																						
	CNMG120416-MF4 CNMG434-MF4	1,6 0.063	12,7 0.500	12,9 0.508	4,76 0.187	5,15 0.203	80,0	0,0						■	■	■																	
Parting-off	CNMG120416-MR4 CNMG434-MR4	1,6 0.063	12,7 0.500	12,9 0.508	4,76 0.187	5,15 0.203	80,0	0,0														■											
	CNMG120416-MR7 CNMG434-MR7	1,6 0.063	12,7 0.500	12,9 0.508	4,76 0.187	5,15 0.203	80,0	0,0	■	■	■		■					■	■														
Adapters Clamping units	CNMA160608 CNMA542	0,8 0.031	15,875 0.625	16,1 0.634	6,35 0.250	6,35 0.250	80,0	0,0										■	■														
	CNMG160608-M1 CNMP542-M1	0,8 0.031	15,875 0.625	16,1 0.634	6,35 0.250	6,35 0.250	80,0	0,0																									
Workpiece materials	CNMG160612-M3 CNMG543-M3	1,2 0.047	15,875 0.625	16,1 0.634	6,35 0.250	6,35 0.250	80,0	0,0	■	■	■	■	■		■	■																	
	CNMG160612-M5 CNMG543-M5	1,2 0.047	15,875 0.625	16,1 0.634	6,35 0.250	6,35 0.250	80,0	0,0	■	■	■	■	■	■	■	■																	

Designation	RE	IC	L	S	D1	EPRS°	AN°	Cemented Carbide and Cermet Grades																		
								Coated												Uncoated			Cermet			
								TP0501	TP1501	TP2501	TP3501	TP25	TP40	TM1501	TM2501	TM3501	TK0501	TK1501	TS2000	TS2050	TS2500	TH1000	TH1500	CP200	CP500	CP600
mm Inch	mm Inch	mm Inch	mm Inch	mm Inch																						
CNMG160612W-M6 CNMG543W-M6	1,2 0.047	15,875 0.625	16,1 0.634	6,35 0.250	6,35 0.250	80,0	0,0																			
CNMG160612-MF4 CNMG543-MF4	1,2 0.047	15,875 0.625	16,12 0.635	6,35 0.250	6,35 0.250	80,0	0,0																			
CNMG160612-MR4 CNMG543-MR4	1,2 0.047	15,875 0.625	16,1 0.634	6,35 0.250	6,35 0.250	80,0	0,0																			
CNMG160612-MR7 CNMG543-MR7	1,2 0.047	15,875 0.625	16,1 0.634	6,35 0.250	6,35 0.250	80,0	0,0																			
CNMM160612-R4 CNMM543-R4	1,2 0.047	15,875 0.625	16,1 0.634	6,35 0.250	6,35 0.250	80,0	0,0																			
CNMM160612-R6 CNMM543-R6	1,2 0.047	15,875 0.625	16,1 0.634	6,35 0.250	6,35 0.250	80,0	0,0																			
CNMM160612-R7 CNMM543-R7	1,2 0.047	15,875 0.625	16,1 0.634	6,35 0.250	6,35 0.250	80,0	0,0																			
CNMM160612-RR6 CNMM543-RR6	1,2 0.047	15,875 0.625	16,12 0.635	6,35 0.250	6,35 0.250	80,0	0,0																			
CNMA160616 CNMA544	1,6 0.063	15,875 0.625	16,1 0.634	6,35 0.250	6,35 0.250	80,0	0,0																			
CNMA160616-MR9 CNMA544-MR9	1,6 0.063	15,875 0.625	16,12 0.635	6,35 0.250	6,35 0.250	80,0	0,0																			
CNMG160616-M3 CNMG544-M3	1,6 0.063	15,875 0.625	16,1 0.634	6,35 0.250	6,35 0.250	80,0	0,0																			
CNMG160616-M5 CNMG544-M5	1,6 0.063	15,875 0.625	16,1 0.634	6,35 0.250	6,35 0.250	80,0	0,0																			
CNMG160616-M6 CNMG544-M6	1,6 0.063	15,875 0.625	16,1 0.634	6,35 0.250	6,35 0.250	80,0	0,0																			
CNMG160616W-M6 CNMG544W-M6	1,6 0.063	15,875 0.625	16,1 0.634	6,35 0.250	6,35 0.250	80,0	0,0																			
CNMG160616-MR7 CNMG544-MR7	1,6 0.063	15,875 0.625	16,1 0.634	6,35 0.250	6,35 0.250	80,0	0,0																			
CNMM160616-R4 CNMM544-R4	1,6 0.063	15,875 0.625	16,1 0.634	6,35 0.250	6,35 0.250	80,0	0,0																			
CNMM160616-R5 CNMM544-R5	1,6 0.063	15,875 0.625	16,1 0.634	6,35 0.250	6,35 0.250	80,0	0,0																			
CNMM160616-R7 CNMM544-R7	1,6 0.063	15,875 0.625	16,1 0.634	6,35 0.250	6,35 0.250	80,0	0,0																			
CNMM160616-RR6 CNMM544-RR6	1,6 0.063	15,875 0.625	16,1 0.634	6,35 0.250	6,35 0.250	80,0	0,0																			
CNMG160624-M6 CNMG546-M6	2,4 0.094	15,875 0.625	16,1 0.634	6,35 0.250	6,35 0.250	80,0	0,0																			
CNMG160624-MR7 CNMG546-MR7	2,4 0.094	15,875 0.625	16,1 0.634	6,35 0.250	6,35 0.250	80,0	0,0																			
CNMM160624-R7 CNMM546-R7	2,4 0.094	15,875 0.625	16,1 0.634	6,35 0.250	6,35 0.250	80,0	0,0																			
CNMG190608-M1 CNMP642-M1	0,8 0.031	19,05 0.750	19,3 0.760	6,35 0.250	7,92 0.312	80,0	0,0																			
CNMG190608-M3 CNMG642-M3	0,8 0.031	19,05 0.750	19,3 0.760	6,35 0.250	7,92 0.312	80,0	0,0																			
CNMG190608-M5 CNMG642-M5	0,8 0.031	19,05 0.750	19,3 0.760	6,35 0.250	7,92 0.312	80,0	0,0																			
CNMG190608-MR7 CNMG642-MR7	0,8 0.031	19,05 0.750	19,3 0.760	6,35 0.250	7,92 0.312	80,0	0,0																			
CNMA190612 CNMA643	1,2 0.047	19,05 0.750	19,3 0.760	6,35 0.250	7,92 0.312	80,0	0,0																			
CNMG190612-M1 CNMP643-M1	1,2 0.047	19,05 0.750	19,3 0.760	6,35 0.250	7,92 0.312	80,0	0,0																			
CNMG190612-M3 CNMG643-M3	1,2 0.047	19,05 0.750	19,3 0.760	6,35 0.250	7,92 0.312	80,0	0,0																			
CNMG190612-M5 CNMG643-M5	1,2 0.047	19,05 0.750	19,3 0.760	6,35 0.250	7,92 0.312	80,0	0,0																			

General ISO Turning Inserts
Steadyline®
MDT
Mini-Shaft™
Grooving
Parting-off
X4
Adapters Clamping units
Accessories and Spare parts
Workpiece materials

General ISO Turning Inserts	Designation	Cemented Carbide and Cermet Grades							Coated												Uncoated				Cermet								
		RE	IC	L	S	D1	EPSR° AN°		TP0501	TP1501	TP2501	TP3501	TP25	TP40	TM1501	TM2501	TM3501	TK0501	TK1501	TS2000	TS2050	TS2500	TH1000	TH1500	CP200	CP500	CP600	HX	KX	883	890	TP1030	TP1020
		mm Inch	mm Inch	mm Inch	mm Inch	mm Inch																											
General ISO Turning Inserts	CNMG190612-M6 CNMG643-M6	1,2 0.047	19,05 0.750	19,3 0.760	6,35 0.250	7,92 0.312	80,0 0,0	■	■	■	■																						
	CNMG190612-MF4 CNMG643-MF4	1,2 0.047	19,05 0.750	19,34 0.761	6,35 0.250	7,92 0.312	80,0 0,0							■	■	■																	
Steadyline®	CNMG190612-MR4 CNMG643-MR4	1,2 0.047	19,05 0.750	19,3 0.760	6,35 0.250	7,92 0.312	80,0 0,0													■													
	CNMG190612-MR7 CNMG643-MR7	1,2 0.047	19,05 0.750	19,3 0.760	6,35 0.250	7,92 0.312	80,0 0,0	■	■	■	■	■	■			■			■														
MDT	CNMM190612-R4 CNMM643-R4	1,2 0.047	19,05 0.750	19,3 0.760	6,35 0.250	7,92 0.312	80,0 0,0	■	■	■	■	■																					
	CNMM190612-R6 CNMM643-R6	1,2 0.047	19,05 0.750	19,3 0.760	6,35 0.250	7,92 0.312	80,0 0,0						■																				
Mini-Shaft™	CNMA190616 CNMA644	1,6 0.063	19,05 0.750	19,3 0.760	6,35 0.250	7,92 0.312	80,0 0,0											■	■														
	CNMG190616-M3 CNMG644-M3	1,6 0.063	19,05 0.750	19,3 0.760	6,35 0.250	7,92 0.312	80,0 0,0		■	■	■	■				■	■																
Grooving	CNMG190616-M5 CNMG644-M5	1,6 0.063	19,05 0.750	19,3 0.760	6,35 0.250	7,92 0.312	80,0 0,0		■	■	■	■	■	■	■				■														
	CNMG190616-M6 CNMG644-M6	1,6 0.063	19,05 0.750	19,3 0.760	6,35 0.250	7,92 0.312	80,0 0,0	■	■	■	■								■														
Parting-off	CNMG190616-MF4 CNMG644-MF4	1,6 0.063	19,05 0.750	19,34 0.761	6,35 0.250	7,92 0.312	80,0 0,0								■	■	■																
	CNMG190616-MR4 CNMG644-MR4	1,6 0.063	19,05 0.750	19,3 0.760	6,35 0.250	7,92 0.312	80,0 0,0																										
X4	CNMG190616-MR7 CNMG644-MR7	1,6 0.063	19,05 0.750	19,3 0.760	6,35 0.250	7,92 0.312	80,0 0,0	■	■	■	■	■				■			■														
	CNMM190616-MR6 CNMM644-MR6	1,6 0.063	19,05 0.750	19,3 0.760	6,35 0.250	7,92 0.312	80,0 0,0		■																								
Adapters Clamping units	CNMM190616-R4 CNMM644-R4	1,6 0.063	19,05 0.750	19,3 0.760	6,35 0.250	7,92 0.312	80,0 0,0	■	■	■	■	■																					
	CNMM190616-R5 CNMM644-R5	1,6 0.063	19,05 0.750	19,3 0.760	6,35 0.250	7,92 0.312	80,0 0,0	■																									
Workpiece materials	CNMM190616-R6 CNMM644-R6	1,6 0.063	19,05 0.750	19,3 0.760	6,35 0.250	7,92 0.312	80,0 0,0						■																				
	CNMM190616-R7 CNMM644-R7	1,6 0.063	19,05 0.750	19,3 0.760	6,35 0.250	7,92 0.312	80,0 0,0		■	■	■																						
Accessories and Spare parts	CNMM190616W-R7 CNMM644W-R7	1,6 0.063	19,05 0.750	19,3 0.760	6,35 0.250	7,92 0.312	80,0 0,0		■	■	■																						
	CNMM190616-R8 CNMM644-R8	1,6 0.063	19,05 0.750	19,3 0.760	6,35 0.250	7,92 0.312	80,0 0,0					■																					
Workpiece materials	CNMM190616-RR6 CNMM644-RR6	1,6 0.063	19,05 0.750	19,3 0.760	6,35 0.250	7,92 0.312	80,0 0,0			■	■			■	■																		
	CNMM190616-RR9 CNMM644-RR9	1,6 0.063	19,05 0.750	19,3 0.760	6,35 0.250	7,92 0.312	80,0 0,0							■																			
Workpiece materials	CNMG190624-M6 CNMG646-M6	2,4 0.094	19,05 0.750	19,3 0.760	6,35 0.250	7,92 0.312	80,0 0,0	■	■	■	■							■															
	CNMG190624-MR7 CNMG646-MR7	2,4 0.094	19,05 0.750	19,3 0.760	6,35 0.250	7,92 0.312	80,0 0,0		■	■			■																				
Workpiece materials	CNMM190624-R4 CNMM646-R4	2,4 0.094	19,05 0.750	19,3 0.760	6,35 0.250	7,92 0.312	80,0 0,0	■	■	■	■																						
	CNMM190624-R5 CNMM646-R5	2,4 0.094	19,05 0.750	19,3 0.760	6,35 0.250	7,92 0.312	80,0 0,0	■																									
Workpiece materials	CNMM190624-R7 CNMM646-R7	2,4 0.094	19,05 0.750	19,3 0.760	6,35 0.250	7,92 0.312	80,0 0,0	■		■	■	■																					
	CNMM190624W-R7 CNMM646W-R7	2,4 0.094	19,05 0.750	19,3 0.760	6,35 0.250	7,92 0.312	80,0 0,0	■	■	■	■	■																					

Designation	RE	IC	L	S	D1	EPSR°	AN°	Cemented Carbide and Cermet Grades																			
								Coated											Uncoated				Cermet				
								TP0501	TP1501	TP2501	TP3501	TP25	TP40	TM1501	TM2501	TM3501	TK0501	TK1501	TS2000	TS2050	TS2500	TH1000	TH1500	CP200	CP500	CP600	HX
mm Inch	mm Inch	mm Inch	mm Inch	mm Inch																							
CNMM190624-RR6 CNMM646-RR6	2,4 0.094	19,05 0.750	19,3 0.760	6,35 0.250	7,92 0.312	80,0	0,0	■		■																	
CNMG250924-MR4 CNMG866-MR4	2,4 0.094	25,4 1.000	25,8 1.016	9,52 0.375	9,12 0.359	80,0	0,0				■																
CNMG250924-MR7 CNMG866-MR7	2,4 0.094	25,4 1.000	25,8 1.016	9,52 0.375	9,12 0.359	80,0	0,0			■	■	■															

- General ISO Turning Inserts
- Steadyline®
- MDT
- Mini-Shaft™
- Grooving
- Parting-off
- X4
- Adapters
Clamping units
- Accessories and
Spare parts
- Workpiece
materials

DCGT, DCMT, DCMX

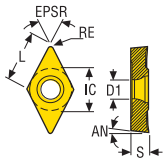

DCGT
Tolerances:
IC = ±0,025/0.001
S = ±0,05/0.002
RE (≥0,2/0.008) = ±0,1/0.004
RE (≤0,1/0.004) = ±0,025/0.001

DCMT
Tolerances:
IC = ±0,05/0.002
IC = ±0,08/0.003
S = ±0,05/0.002
S = ±0,13/0.005
RE = ±0,1/0.004

DCMX
Tolerances:
IC = ±0,05/0.002
S = ±0,05/0.002
RE = ±0,1/0.004

Please check availability at
www.secotools.com / Seco Online Store

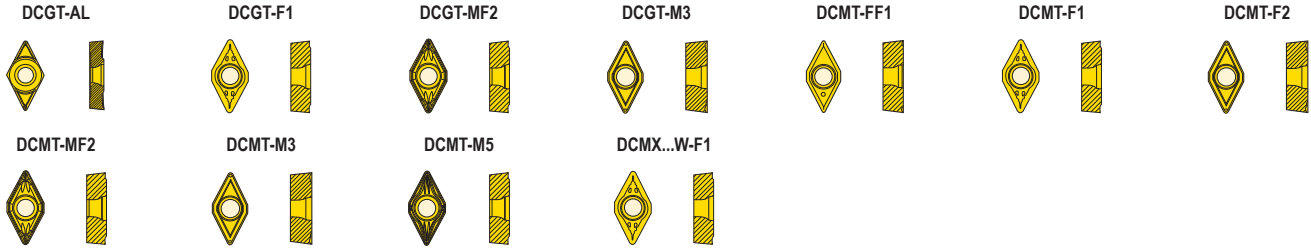

Designation	RE	IC	L	S	D1	EPSR°	AN°	Cemented Carbide and Cermet Grades																		
								Coated										Uncoated				Cermet				
								TP0501	TP1501	TP2501	TP3501	TP25	TP40	TM1501	TM2501	TM3501	TK0501	TK1501	TS2000	TS2050	TS2500	TH1000	TH1500	CP200	CP500	CP600
mm	mm	mm	mm	mm	mm	mm	mm	mm	mm	mm	mm	mm	mm	mm	mm	mm	mm	mm	mm	mm	mm	mm	mm	mm	mm	
DCGT0702005F-AL DCGT21.50.0F-AL	0,05 0.002	6,35 0.250	7,755 0.305	2,38 0.094	2,8 0.110	55,0	7,0																			
DCGT0702005F-1 DCGT21.50.0F-1	0,05 0.002	6,35 0.250	7,8 0.307	2,38 0.094	2,9 0.114	55,0	7,0																			
DCGT070201F-AL DCGT21.50F-AL	0,1 0.004	6,35 0.250	7,755 0.305	2,38 0.094	2,8 0.110	55,0	7,0																			
DCGT070201F-1 DCGT21.50F-1	0,1 0.004	6,35 0.250	7,8 0.307	2,38 0.094	2,9 0.114	55,0	7,0																			
DCGT070201MF2 DCGT21.50MF2	0,1 0.004	6,35 0.250	7,75 0.305	2,38 0.094	2,9 0.114	55,0	7,0																			
DCGT070202F-AL DCGT21.50.5F-AL	0,2 0.008	6,35 0.250	7,8 0.307	2,38 0.094	2,8 0.110	55,0	7,0																			
DCGT070202M3 DCGT21.50.5M3	0,2 0.008	6,35 0.250	7,8 0.307	2,38 0.094	2,9 0.114	55,0	7,0																			
DCGT070202MF2 DCGT21.50.5MF2	0,2 0.008	6,35 0.250	7,75 0.305	2,38 0.094	2,9 0.114	55,0	7,0																			
DCMT070202F-1 DCMT21.50.5F-1	0,2 0.008	6,35 0.250	7,8 0.307	2,38 0.094	2,9 0.114	55,0	7,0																			
DCMT070202F-2 DCMT21.50.5F-2	0,2 0.008	6,35 0.250	7,8 0.307	2,38 0.094	2,9 0.114	55,0	7,0																			
DCMT070202M3 DCMT21.50.5M3	0,2 0.008	6,35 0.250	7,8 0.307	2,38 0.094	2,9 0.114	55,0	7,0																			
DCMT070202MF2 DCMT21.50.5MF2	0,2 0.008	6,35 0.250	7,8 0.307	2,38 0.094	2,9 0.114	55,0	7,0																			
DCMT070204F-1 DCMT21.51F-1	0,4 0.016	6,35 0.250	7,8 0.307	2,38 0.094	2,9 0.114	55,0	7,0																			
DCMT070204F-2 DCMT21.51F-2	0,4 0.016	6,35 0.250	7,8 0.307	2,38 0.094	2,9 0.114	55,0	7,0																			
DCMT070204M3 DCMT21.51M3	0,4 0.016	6,35 0.250	7,8 0.307	2,38 0.094	2,9 0.114	55,0	7,0																			
DCMT070204MF2 DCMT21.51MF2	0,4 0.016	6,35 0.250	7,8 0.307	2,38 0.094	2,9 0.114	55,0	7,0																			
DCMT070208F-1 DCMT21.52F-1	0,8 0.031	6,35 0.250	7,8 0.307	2,38 0.094	2,9 0.114	55,0	7,0																			
DCMT070208F-2 DCMT21.52F-2	0,8 0.031	6,35 0.250	7,8 0.307	2,38 0.094	2,9 0.114	55,0	7,0																			
DCMT070208M3 DCMT21.52M3	0,8 0.031	6,35 0.250	7,8 0.307	2,38 0.094	2,9 0.114	55,0	7,0																			

Designation	RE	IC	L	S	D1	EPRS°	AN°	Cemented Carbide and Cermet Grades																			
								Coated												Uncoated				Cermet			
								TP0501	TP1501	TP2501	TP3501	TP25	TP40	TM1501	TM2501	TM3501	TK0501	TK1501	TS2000	TS2050	TS2500	TH1000	TH1500	CP200	CP500	CP600	HX
mm Inch	mm Inch	mm Inch	mm Inch	mm Inch																							
DCMT070208-MF2 DCMT21.52-MF2	0,8 0.031	6,35 0.250	7,8 0.307	2,38 0.094	2,9 0.114	55,0	7,0																				
DCGT11T301-F1 DCGT32.50-F1	0,1 0.004	9,525 0.375	11,6 0.457	3,97 0.156	4,5 0.177	55,0	7,0																				
DCGT11T301-MF2 DCGT32.50-MF2	0,1 0.004	9,525 0.375	11,6 0.457	3,97 0.156	4,5 0.177	55,0	7,0																				
DCGT11T302F-AL DCGT32.50.5F-AL	0,2 0.008	9,525 0.375	11,6 0.457	3,97 0.156	4,4 0.173	55,0	7,0																				
DCGT11T302-M3 DCGT32.50.5-M3	0,2 0.008	9,525 0.375	11,6 0.457	3,97 0.156	4,5 0.177	55,0	7,0																				
DCGT11T302-MF2 DCGT32.50.5-MF2	0,2 0.008	9,525 0.375	11,6 0.457	3,97 0.156	4,5 0.177	55,0	7,0																				
DCMT11T302-F1 DCMT32.50.5-F1	0,2 0.008	9,525 0.375	11,6 0.457	3,97 0.156	4,5 0.177	55,0	7,0																				
DCMT11T302-F2 DCMT32.50.5-F2	0,2 0.008	9,525 0.375	11,6 0.457	3,97 0.156	4,5 0.177	55,0	7,0																				
DCMT11T302-FF1 DCMT32.50.5-FF1	0,2 0.008	9,525 0.375	11,6 0.457	3,97 0.156	4,5 0.177	55,0	7,0																				
DCMT11T302-M3 DCMT32.50.5-M3	0,2 0.008	9,525 0.375	11,6 0.457	3,97 0.156	4,5 0.177	55,0	7,0																				
DCMT11T302-MF2 DCMT32.50.5-MF2	0,2 0.008	9,525 0.375	11,6 0.457	3,97 0.156	4,5 0.177	55,0	7,0																				
DCGT11T304F-AL DCGT32.51F-AL	0,4 0.016	9,525 0.375	11,6 0.457	3,97 0.156	4,4 0.173	55,0	7,0																				
DCGT11T304-F1 DCGT32.51-F1	0,4 0.016	9,525 0.375	11,6 0.457	3,97 0.156	4,5 0.177	55,0	7,0																				
DCGT11T304-M3 DCGT32.51-M3	0,4 0.016	9,525 0.375	11,6 0.457	3,97 0.156	4,5 0.177	55,0	7,0																				
DCGT11T304-MF2 DCGT32.51-MF2	0,4 0.016	9,525 0.375	11,6 0.457	3,97 0.156	4,5 0.177	55,0	7,0																				
DCMT11T304-F1 DCMT32.51-F1	0,4 0.016	9,525 0.375	11,6 0.457	3,97 0.156	4,5 0.177	55,0	7,0																				
DCMT11T304-F2 DCMT32.51-F2	0,4 0.016	9,525 0.375	11,6 0.457	3,97 0.156	4,5 0.177	55,0	7,0																				
DCMT11T304-FF1 DCMT32.51-FF1	0,4 0.016	9,525 0.375	11,6 0.457	3,97 0.156	4,5 0.177	55,0	7,0																				
DCMT11T304-M3 DCMT32.51-M3	0,4 0.016	9,525 0.375	11,6 0.457	3,97 0.156	4,5 0.177	55,0	7,0																				
DCMT11T304-MF2 DCMT32.51-MF2	0,4 0.016	9,525 0.375	11,6 0.457	3,97 0.156	4,5 0.177	55,0	7,0																				
DCMX11T304W-F1 DCMX32.51W-F1	0,4 0.016	9,525 0.375	11,6 0.457	3,97 0.156	4,5 0.177	55,0	7,0																				
DCGT11T308F-AL DCGT32.52F-AL	0,8 0.031	9,525 0.375	11,6 0.457	3,97 0.156	4,4 0.173	55,0	7,0																				
DCGT11T308-F1 DCGT32.52-F1	0,8 0.031	9,525 0.375	11,6 0.457	3,969 0.156	4,5 0.177	55,0	7,0																				
DCGT11T308-M3 DCGT32.52-M3	0,8 0.031	9,525 0.375	11,6 0.457	3,97 0.156	4,5 0.177	55,0	7,0																				
DCMT11T308-F1 DCMT32.52-F1	0,8 0.031	9,525 0.375	11,6 0.457	3,97 0.156	4,5 0.177	55,0	7,0																				
DCMT11T308-F2 DCMT32.52-F2	0,8 0.031	9,525 0.375	11,6 0.457	3,97 0.156	4,5 0.177	55,0	7,0																				
DCMT11T308-FF1 DCMT32.52-FF1	0,8 0.031	9,525 0.375	11,6 0.457	3,97 0.156	4,5 0.177	55,0	7,0																				
DCMT11T308-M3 DCMT32.52-M3	0,8 0.031	9,525 0.375	11,6 0.457	3,97 0.156	4,5 0.177	55,0	7,0																				
DCMT11T308-M5 DCMT32.52-M5	0,8 0.031	9,525 0.375	11,6 0.457	3,97 0.156	4,5 0.177	55,0	7,0																				
DCMT11T308-MF2 DCMT32.52-MF2	0,8 0.031	9,525 0.375	11,6 0.457	3,97 0.156	4,5 0.177	55,0	7,0																				

General ISO Turning Inserts

Steadyline

MDT

Mini-Shaft™

Grooving

Parting-off

X4

Adapters Clamping units

Accessories and Spare parts

Workpiece materials

General ISO Turning Inserts	Designation	RE	IC	L	S	D1	E	PSR°	AN°	Cemented Carbide and Cermet Grades																			
										Coated															Uncoated				Cermet
										TP0601	TP1601	TP2601	TP3601	TP25	TP40	TM1601	TM2601	TM3601	TK0601	TK1601	TS2000	TS2050	TS2600	TH1000	TH1600	CP200	CP500	CP600	HX
mm Inch	mm Inch	mm Inch	mm Inch	mm Inch																									
General ISO Turning Inserts	DCMX11T308W-F1	0,8	9,525	11,6	3,97	4,5	55,0	7,0		■	■															■			
	DCMX32.52W-F1	0.031	0.375	0.457	0.156	0.177																							
General ISO Turning Inserts	DCMT11T312-F1	1,2	9,525	11,6	3,97	4,5	55,0	7,0		■	■																		
	DCMT32.53-F1	0.047	0.375	0.457	0.156	0.177																							
Steadyline®	DCMT11T312-M5	1,2	9,525	11,6	3,97	4,5	55,0	7,0			■	■																	
	DCMT32.53-M5	0.047	0.375	0.457	0.156	0.177																							
Steadyline®	DCMT11T312-MF2	1,2	9,525	11,6	3,97	4,5	55,0	7,0			■																		
	DCMT32.53-MF2	0.047	0.375	0.457	0.156	0.177																							
MDT	DCGT150404-M3	0,4	12,7	15,5	4,76	5,6	55,0	7,0																					
	DCGT431-M3	0.016	0.500	0.610	0.187	0.220																							
MDT	DCMT150404-F2	0,4	12,7	15,5	4,76	5,6	55,0	7,0																					
	DCMT431-F2	0.016	0.500	0.610	0.187	0.220																							
MDT	DCMT150404-M3	0,4	12,7	15,5	4,76	5,6	55,0	7,0		■	■	■	■																
	DCMT431-M3	0.016	0.500	0.610	0.187	0.220																							
Mini-Shaft™	DCGT150408-M3	0,8	12,7	15,5	4,76	5,6	55,0	7,0																					
	DCGT150408-M3	0.031	0.500	0.610	0.187	0.220																							
Mini-Shaft™	DCMT150408-F2	0,8	12,7	15,5	4,76	5,6	55,0	7,0																					
	DCMT432-F2	0.031	0.500	0.610	0.187	0.220																							
Mini-Shaft™	DCMT150408-M3	0,8	12,7	15,5	4,76	5,6	55,0	7,0		■	■	■	■																
	DCMT432-M3	0.031	0.500	0.610	0.187	0.220																							
Mini-Shaft™	DCMT150412-M3	1,2	12,7	15,5	4,76	5,6	55,0	7,0		■	■	■																	
	DCMT433-M3	0.047	0.500	0.610	0.187	0.220																							

* Right-hand version shown
Please check availability at www.secotools.com / Seco Online Store

DNMG, DNMG
Tolerances:
IC = ±0,025/0.001
S = ±0,13/0.005
RE = ±0,1/0.004

DNMA, DNMG, DNMM
Tolerances:
IC = ±0,08/0.003
S = ±0,13/0.005
RE = ±0,1/0.004

DNMG, DNMG, DNMA, DNMG, DNMM, DNMU, DNMX

DNMU, DNMX
Tolerances:
IC = ±0,05/0.002
S = ±0,08/0.003
RE = ±0,13/0.005
RE = ±0,1/0.004

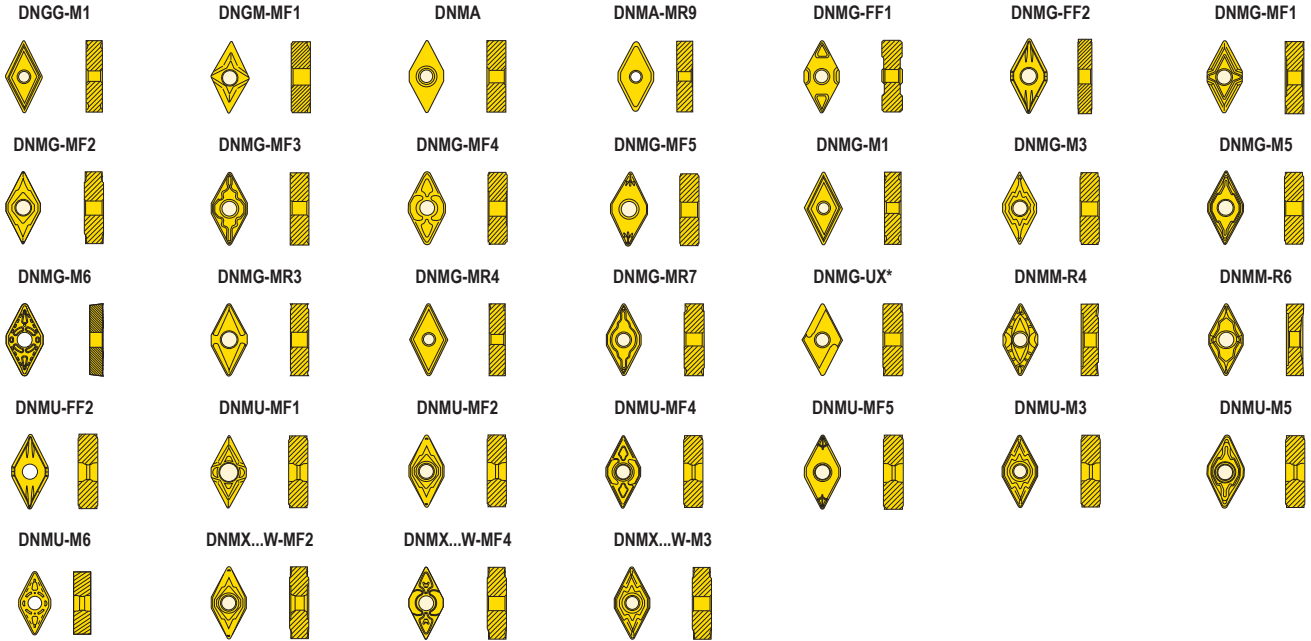
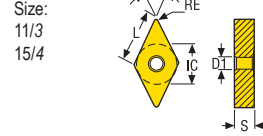

Designation	RE	IC	L	S	D1	EPSR°	AN°	Cemented Carbide and Cermet Grades																										
								Coated							Uncoated			Cermet																
	mm	mm	mm	mm	mm			TP0501	TP1501	TP2501	TP3501	TP25	TP40	TM1501	TM2501	TM3501	TK0501	TK1501	TS2000	TS2050	TS2500	TH1000	TH1500	CP200	CP500	CP600	HX	KX	883	890	TP1030	TP1020		
	Inch	Inch	Inch	Inch	Inch																													
DNMU110402-M3 <i>DNMU330.5-M3</i>	0,2 0.008	9,525 0.375	11,6 0.457	4,76 0.187	3,81 0.150	55,0	0,0		■		■					■																		
DNMU110404-FF2 <i>DNMU331-FF2</i>	0,4 0.016	9,525 0.375	11,6 0.457	4,76 0.187	3,81 0.150	55,0	0,0		■	■	■														■								■	
DNMU110404-M3 <i>DNMU331-M3</i>	0,4 0.016	9,525 0.375	11,6 0.457	4,76 0.187	3,81 0.150	55,0	0,0		■	■	■	■			■	■		■				■	■											
DNMU110404-MF1 <i>DNMU331-MF1</i>	0,4 0.016	9,525 0.375	11,63 0.458	4,762 0.187	3,81 0.150	55,0	0,0							■	■	■									■									
DNMU110404-MF2 <i>DNMU331-MF2</i>	0,4 0.016	9,525 0.375	11,6 0.457	4,76 0.187	3,81 0.150	55,0	0,0	■	■	■	■	■										■											■	
DNMU110404-MF4 <i>DNMU331-MF4</i>	0,4 0.016	9,525 0.375	11,63 0.458	4,762 0.187	3,81 0.150	55,0	0,0							■	■	■																		
DNMU110404-MF5 <i>DNMU331-MF5</i>	0,4 0.016	9,525 0.375	11,6 0.457	4,76 0.187	3,81 0.150	55,0	0,0					■																						
DNMX110404W-MF2 <i>DNMX331W-MF2</i>	0,4 0.016	9,525 0.375	11,6 0.457	4,76 0.187	3,81 0.150	55,0	0,0		■	■		■																						
DNMU110408-FF2 <i>DNMU332-FF2</i>	0,8 0.031	9,525 0.375	11,6 0.457	4,76 0.187	3,81 0.150	55,0	0,0		■	■	■	■													■								■	
DNMU110408-M3 <i>DNMU332-M3</i>	0,8 0.031	9,525 0.375	11,6 0.457	4,76 0.187	3,81 0.150	55,0	0,0		■	■	■	■			■	■						■	■											
DNMU110408-M5 <i>DNMU332-M5</i>	0,8 0.031	9,525 0.375	11,6 0.457	4,76 0.187	3,81 0.150	55,0	0,0			■															■									
DNMU110408-M6 <i>DNMU332-M6</i>	0,8 0.031	9,525 0.375	11,6 0.457	4,76 0.187	3,81 0.150	55,0	0,0		■	■	■														■									
DNMU110408-MF1 <i>DNMU332-MF1</i>	0,8 0.031	9,525 0.375	11,63 0.458	4,762 0.187	3,81 0.150	55,0	0,0							■	■	■																		
DNMU110408-MF2 <i>DNMU332-MF2</i>	0,8 0.031	9,525 0.375	11,6 0.457	4,76 0.187	3,81 0.150	55,0	0,0	■	■	■	■	■										■												■

General ISO Turning Inserts
Steadyline®
MDT
Mini-Shaft™
Grooving
Parting-off
X4
Adapters Clamping units
Accessories and Spare parts
Workpiece materials

General ISO Turning Inserts	Designation	Cemented Carbide and Cermet Grades																																																																																																																																																																																																																																																																																																																																																																																																																																																																																																																																																																																																																																																																																																																																																																												
		RE	IC	L	S	D1	EPSR°	AN°	Coated															Uncoated				Cermet																																																																																																																																																																																																																																																																																																																																																																																																																																																																																																																																																																																																																																																																																																																																																		
									TP0501	TP1501	TP2501	TP3501	TP25	TP40	TM1501	TM2501	TM3501	TK0501	TK1501	TS2000	TS2050	TS2500	TH1000	TH1500	CP200	CP500	CP600	HX	KX	883	890	TP1030	TP1020																																																																																																																																																																																																																																																																																																																																																																																																																																																																																																																																																																																																																																																																																																																																													
		mm Inch	mm Inch	mm Inch	mm Inch	mm Inch																																																																																																																																																																																																																																																																																																																																																																																																																																																																																																																																																																																																																																																																																																																																																																								
General ISO Turning Inserts	DNMU110408-MF4	0,8	9,525	11,63	4,762	3,81	55,0	0,0							■	■	■																																																																																																																																																																																																																																																																																																																																																																																																																																																																																																																																																																																																																																																																																																																																																													
	DNMU332-MF4	0.031	0.375	0.458	0.187	0.150												Steadyline®	DNMU110408-MF5	0,8	9,525	11,6	4,76	3,81	55,0	0,0			■							DNMU332-MF5	0.031	0.375	0.457	0.187	0.150												MDT	DNMU110412-M3	1,2	9,525	11,6	4,76	3,81	55,0	0,0	■	■								DNMU333-M3	0.047	0.375	0.457	0.187	0.150												Mini-Shaft™	DNMU110412-M5	1,2	9,525	11,6	4,76	3,81	55,0	0,0		■								DNMU333-M5	0.047	0.375	0.457	0.187	0.150												Grooving	DNMG150402-M1	0,2	12,7	15,5	4,76	5,15	55,0	0,0											DNGP430.5F-M1	0.008	0.500	0.610	0.187	0.203													Parting-off	DNMG150404-M1	0,4	12,7	15,5	4,76	5,15	55,0	0,0											DNGP431F-M1	0.016	0.500	0.610	0.187	0.203													Adapters Clamping units	DNMG150404-M1	0,4	12,7	15,5	4,76	5,15	55,0	0,0	■	■									DNMP431-M1	0.016	0.500	0.610	0.187	0.203													Workpiece materials	DNMG150404-M3	0,4	12,7	15,5	4,76	5,15	55,0	0,0	■	■	■	■							DNMG431-M3	0.016	0.500	0.610	0.187	0.203													Accessories and Spare parts	DNMG150404-M5	0,4	12,7	15,5	4,76	5,15	55,0	0,0					■						DNMG431-M5	0.016	0.500	0.610	0.187	0.203													Adapters Clamping units	DNMG150404-MF1	0,4	12,7	15,5	4,76	5,15	55,0	0,0						■					DNMP431-MF1	0.016	0.500	0.610	0.187	0.203													Workpiece materials	DNMG150404-MF2	0,4	12,7	15,5	4,76	5,15	55,0	0,0	■	■	■	■							DNMG431-MF2	0.016	0.500	0.610	0.187	0.203													Accessories and Spare parts	DNMG150404-MF3	0,4	12,7	15,5	4,76	5,15	55,0	0,0				■							DNMG431-MF3	0.016	0.500	0.610	0.187	0.203													Workpiece materials	DNMG150404-MF4	0,4	12,7	15,5	4,762	5,15	55,0	0,0							■	■			DNMG431-MF4	0.016	0.500	0.610	0.187	0.203													Adapters Clamping units	DNMG150408-M1	0,8	12,7	15,5	4,76	5,15	55,0	0,0											DNGP432F-M1	0.031	0.500	0.610	0.187	0.203													Workpiece materials	DNMG150408-MF1	0,8	12,7	15,5	4,76	5,15	55,0	0,0											DNGM432-MF1	0.031	0.500	0.610	0.187	0.203													Workpiece materials	DNMA150408	0,8	12,7	15,5	4,76	5,15	55,0	0,0											DNMA432	0.031	0.500	0.610	0.187	0.203													Adapters Clamping units	DNMG150408-M3	0,8	12,7	15,5	4,76	5,15	55,0	0,0	■	■	■	■							DNMG432-M3	0.031	0.500	0.610	0.187	0.203													Workpiece materials	DNMG150408-M5	0,8	12,7	15,5	4,76	5,15	55,0	0,0	■	■	■	■							DNMG432-M5	0.031	0.500	0.610	0.187	0.203													Accessories and Spare parts	DNMG150408-M6	0,8	12,7	15,5	4,76	5,15	55,0	0,0			■	■							DNMG432-M6	0.031	0.500	0.610	0.187	0.203													Workpiece materials	DNMG150408-MF3	0,8	12,7	15,5	4,76	5,15	55,0	0,0							■				DNMG432-MF3	0.031	0.500	0.610	0.187	0.203													Workpiece materials	DNMG150408-MF4	0,8	12,7	15,5	4,76	5,15	55,0	0,0				■							DNMG432-MF4	0.031	0.500	0.610	0.187	0.203											
Steadyline®	DNMU110408-MF5	0,8	9,525	11,6	4,76	3,81	55,0	0,0			■								DNMU332-MF5	0.031	0.375	0.457	0.187	0.150												MDT	DNMU110412-M3	1,2	9,525	11,6	4,76	3,81	55,0	0,0	■	■									DNMU333-M3	0.047	0.375	0.457	0.187	0.150												Mini-Shaft™	DNMU110412-M5	1,2	9,525	11,6	4,76	3,81	55,0	0,0		■									DNMU333-M5	0.047	0.375	0.457	0.187	0.150												Grooving	DNMG150402-M1	0,2	12,7	15,5	4,76	5,15	55,0	0,0												DNGP430.5F-M1	0.008	0.500	0.610	0.187	0.203													Parting-off	DNMG150404-M1	0,4	12,7	15,5	4,76	5,15	55,0	0,0												DNGP431F-M1	0.016	0.500	0.610	0.187	0.203													Adapters Clamping units	DNMG150404-M1	0,4	12,7	15,5	4,76	5,15	55,0	0,0	■	■										DNMP431-M1	0.016	0.500	0.610	0.187	0.203													Workpiece materials	DNMG150404-M3	0,4	12,7	15,5	4,76	5,15	55,0	0,0	■	■	■		■							DNMG431-M3	0.016	0.500	0.610	0.187	0.203													Accessories and Spare parts	DNMG150404-M5	0,4	12,7	15,5	4,76	5,15	55,0	0,0						■						DNMG431-M5	0.016	0.500	0.610	0.187	0.203													Adapters Clamping units	DNMG150404-MF1	0,4	12,7	15,5	4,76	5,15	55,0	0,0							■					DNMP431-MF1	0.016	0.500	0.610	0.187	0.203													Workpiece materials	DNMG150404-MF2	0,4	12,7	15,5	4,76	5,15	55,0	0,0		■	■	■	■							DNMG431-MF2	0.016	0.500	0.610	0.187	0.203													Accessories and Spare parts	DNMG150404-MF3	0,4	12,7	15,5	4,76	5,15	55,0		0,0				■							DNMG431-MF3	0.016	0.500	0.610	0.187	0.203													Workpiece materials	DNMG150404-MF4	0,4	12,7	15,5	4,762	5,15		55,0	0,0							■	■			DNMG431-MF4	0.016	0.500	0.610	0.187	0.203													Adapters Clamping units	DNMG150408-M1	0,8	12,7	15,5	4,76		5,15	55,0	0,0											DNGP432F-M1	0.031	0.500	0.610	0.187	0.203													Workpiece materials	DNMG150408-MF1	0,8	12,7	15,5		4,76	5,15	55,0	0,0											DNGM432-MF1	0.031	0.500	0.610	0.187	0.203													Workpiece materials	DNMA150408	0,8	12,7		15,5	4,76	5,15	55,0	0,0											DNMA432	0.031	0.500	0.610	0.187	0.203													Adapters Clamping units	DNMG150408-M3	0,8		12,7	15,5	4,76	5,15	55,0	0,0	■	■	■	■							DNMG432-M3	0.031	0.500	0.610	0.187	0.203													Workpiece materials	DNMG150408-M5		0,8	12,7	15,5	4,76	5,15	55,0	0,0	■	■	■	■							DNMG432-M5	0.031	0.500	0.610	0.187	0.203													Accessories and Spare parts		DNMG150408-M6	0,8	12,7	15,5	4,76	5,15	55,0	0,0			■	■							DNMG432-M6	0.031	0.500	0.610	0.187	0.203														Workpiece materials	DNMG150408-MF3	0,8	12,7	15,5	4,76	5,15	55,0	0,0							■				DNMG432-MF3	0.031	0.500	0.610	0.187	0.203														Workpiece materials	DNMG150408-MF4	0,8	12,7	15,5	4,76	5,15	55,0	0,0				■							DNMG432-MF4	0.031	0.500	0.610	0.187	0.203									
	DNMU332-MF5	0.031	0.375	0.457	0.187	0.150												MDT	DNMU110412-M3	1,2	9,525	11,6	4,76	3,81	55,0	0,0	■	■									DNMU333-M3	0.047	0.375	0.457	0.187	0.150												Mini-Shaft™	DNMU110412-M5	1,2	9,525	11,6	4,76	3,81	55,0	0,0		■									DNMU333-M5	0.047	0.375	0.457	0.187	0.150												Grooving	DNMG150402-M1	0,2	12,7	15,5	4,76	5,15	55,0	0,0												DNGP430.5F-M1	0.008	0.500	0.610	0.187	0.203													Parting-off	DNMG150404-M1	0,4	12,7	15,5	4,76	5,15	55,0	0,0												DNGP431F-M1	0.016	0.500	0.610	0.187	0.203													Adapters Clamping units	DNMG150404-M1	0,4	12,7	15,5	4,76	5,15	55,0	0,0	■	■										DNMP431-M1	0.016	0.500	0.610	0.187	0.203													Workpiece materials	DNMG150404-M3	0,4	12,7	15,5	4,76	5,15	55,0	0,0	■	■	■	■								DNMG431-M3	0.016	0.500	0.610	0.187	0.203													Accessories and Spare parts	DNMG150404-M5	0,4	12,7	15,5	4,76	5,15	55,0	0,0					■							DNMG431-M5	0.016	0.500	0.610	0.187	0.203													Adapters Clamping units	DNMG150404-MF1	0,4	12,7	15,5	4,76	5,15	55,0	0,0						■						DNMP431-MF1	0.016	0.500	0.610	0.187	0.203													Workpiece materials	DNMG150404-MF2	0,4	12,7	15,5	4,76	5,15	55,0	0,0	■	■	■	■								DNMG431-MF2	0.016	0.500	0.610	0.187	0.203													Accessories and Spare parts	DNMG150404-MF3	0,4	12,7	15,5	4,76	5,15	55,0	0,0				■								DNMG431-MF3	0.016	0.500	0.610	0.187	0.203													Workpiece materials	DNMG150404-MF4	0,4	12,7	15,5	4,762	5,15	55,0	0,0							■	■				DNMG431-MF4	0.016	0.500	0.610	0.187	0.203													Adapters Clamping units	DNMG150408-M1	0,8	12,7	15,5	4,76	5,15	55,0	0,0												DNGP432F-M1	0.031	0.500	0.610	0.187	0.203													Workpiece materials	DNMG150408-MF1	0,8	12,7	15,5	4,76	5,15	55,0	0,0												DNGM432-MF1	0.031	0.500	0.610	0.187	0.203													Workpiece materials	DNMA150408	0,8	12,7	15,5	4,76	5,15	55,0	0,0												DNMA432	0.031	0.500	0.610	0.187	0.203													Adapters Clamping units	DNMG150408-M3	0,8	12,7	15,5	4,76	5,15	55,0	0,0	■	■	■	■								DNMG432-M3	0.031	0.500	0.610	0.187	0.203													Workpiece materials	DNMG150408-M5	0,8	12,7	15,5	4,76	5,15	55,0	0,0	■	■	■	■								DNMG432-M5	0.031	0.500	0.610	0.187	0.203													Accessories and Spare parts	DNMG150408-M6	0,8	12,7	15,5	4,76	5,15	55,0	0,0			■	■								DNMG432-M6	0.031	0.500	0.610	0.187	0.203													Workpiece materials	DNMG150408-MF3	0,8	12,7	15,5	4,76	5,15	55,0	0,0							■					DNMG432-MF3	0.031	0.500	0.610	0.187	0.203													Workpiece materials	DNMG150408-MF4	0,8	12,7	15,5	4,76	5,15	55,0	0,0				■								DNMG432-MF4	0.031	0.500	0.610	0.187	0.203																											
MDT	DNMU110412-M3	1,2	9,525	11,6	4,76	3,81	55,0	0,0	■	■									DNMU333-M3	0.047	0.375	0.457	0.187	0.150												Mini-Shaft™	DNMU110412-M5	1,2	9,525	11,6	4,76	3,81	55,0	0,0		■									DNMU333-M5	0.047	0.375	0.457	0.187	0.150												Grooving	DNMG150402-M1	0,2	12,7	15,5	4,76	5,15	55,0	0,0												DNGP430.5F-M1	0.008	0.500	0.610	0.187	0.203													Parting-off	DNMG150404-M1	0,4	12,7	15,5	4,76	5,15	55,0	0,0												DNGP431F-M1	0.016	0.500	0.610	0.187	0.203													Adapters Clamping units	DNMG150404-M1	0,4	12,7	15,5	4,76	5,15	55,0	0,0	■	■										DNMP431-M1	0.016	0.500	0.610	0.187	0.203													Workpiece materials	DNMG150404-M3	0,4	12,7	15,5	4,76	5,15	55,0	0,0	■	■	■	■								DNMG431-M3	0.016	0.500	0.610	0.187	0.203													Accessories and Spare parts	DNMG150404-M5	0,4	12,7	15,5	4,76	5,15	55,0	0,0					■							DNMG431-M5	0.016	0.500	0.610	0.187	0.203													Adapters Clamping units	DNMG150404-MF1	0,4	12,7	15,5	4,76	5,15	55,0	0,0						■						DNMP431-MF1	0.016	0.500	0.610	0.187	0.203													Workpiece materials	DNMG150404-MF2	0,4	12,7	15,5	4,76	5,15	55,0	0,0	■	■	■	■								DNMG431-MF2	0.016	0.500	0.610	0.187	0.203													Accessories and Spare parts	DNMG150404-MF3	0,4	12,7	15,5	4,76	5,15	55,0	0,0				■								DNMG431-MF3	0.016	0.500	0.610	0.187	0.203													Workpiece materials	DNMG150404-MF4	0,4	12,7	15,5	4,762	5,15	55,0	0,0							■	■				DNMG431-MF4	0.016	0.500	0.610	0.187	0.203													Adapters Clamping units	DNMG150408-M1	0,8	12,7	15,5	4,76	5,15	55,0	0,0												DNGP432F-M1	0.031	0.500	0.610	0.187	0.203													Workpiece materials	DNMG150408-MF1	0,8	12,7	15,5	4,76	5,15	55,0	0,0												DNGM432-MF1	0.031	0.500	0.610	0.187	0.203													Workpiece materials	DNMA150408	0,8	12,7	15,5	4,76	5,15	55,0	0,0												DNMA432	0.031	0.500	0.610	0.187	0.203													Adapters Clamping units	DNMG150408-M3	0,8	12,7	15,5	4,76	5,15	55,0	0,0	■	■	■	■								DNMG432-M3	0.031	0.500	0.610	0.187	0.203													Workpiece materials	DNMG150408-M5	0,8	12,7	15,5	4,76	5,15	55,0	0,0	■	■	■	■								DNMG432-M5	0.031	0.500	0.610	0.187	0.203													Accessories and Spare parts	DNMG150408-M6	0,8	12,7	15,5	4,76	5,15	55,0	0,0			■	■								DNMG432-M6	0.031	0.500	0.610	0.187	0.203													Workpiece materials	DNMG150408-MF3	0,8	12,7	15,5	4,76	5,15	55,0	0,0							■					DNMG432-MF3	0.031	0.500	0.610	0.187	0.203													Workpiece materials	DNMG150408-MF4	0,8	12,7	15,5	4,76	5,15	55,0	0,0				■								DNMG432-MF4	0.031	0.500	0.610	0.187	0.203																																													
	DNMU333-M3	0.047	0.375	0.457	0.187	0.150												Mini-Shaft™	DNMU110412-M5	1,2	9,525	11,6	4,76	3,81	55,0	0,0		■									DNMU333-M5	0.047	0.375	0.457	0.187	0.150												Grooving	DNMG150402-M1	0,2	12,7	15,5	4,76	5,15	55,0	0,0												DNGP430.5F-M1	0.008	0.500	0.610	0.187	0.203													Parting-off	DNMG150404-M1	0,4	12,7	15,5	4,76	5,15	55,0	0,0												DNGP431F-M1	0.016	0.500	0.610	0.187	0.203													Adapters Clamping units	DNMG150404-M1	0,4	12,7	15,5	4,76	5,15	55,0	0,0	■	■										DNMP431-M1	0.016	0.500	0.610	0.187	0.203													Workpiece materials	DNMG150404-M3	0,4	12,7	15,5	4,76	5,15	55,0	0,0	■	■	■	■								DNMG431-M3	0.016	0.500	0.610	0.187	0.203													Accessories and Spare parts	DNMG150404-M5	0,4	12,7	15,5	4,76	5,15	55,0	0,0					■							DNMG431-M5	0.016	0.500	0.610	0.187	0.203													Adapters Clamping units	DNMG150404-MF1	0,4	12,7	15,5	4,76	5,15	55,0	0,0						■						DNMP431-MF1	0.016	0.500	0.610	0.187	0.203													Workpiece materials	DNMG150404-MF2	0,4	12,7	15,5	4,76	5,15	55,0	0,0	■	■	■	■								DNMG431-MF2	0.016	0.500	0.610	0.187	0.203													Accessories and Spare parts	DNMG150404-MF3	0,4	12,7	15,5	4,76	5,15	55,0	0,0				■								DNMG431-MF3	0.016	0.500	0.610	0.187	0.203													Workpiece materials	DNMG150404-MF4	0,4	12,7	15,5	4,762	5,15	55,0	0,0							■	■				DNMG431-MF4	0.016	0.500	0.610	0.187	0.203													Adapters Clamping units	DNMG150408-M1	0,8	12,7	15,5	4,76	5,15	55,0	0,0												DNGP432F-M1	0.031	0.500	0.610	0.187	0.203													Workpiece materials	DNMG150408-MF1	0,8	12,7	15,5	4,76	5,15	55,0	0,0												DNGM432-MF1	0.031	0.500	0.610	0.187	0.203													Workpiece materials	DNMA150408	0,8	12,7	15,5	4,76	5,15	55,0	0,0												DNMA432	0.031	0.500	0.610	0.187	0.203													Adapters Clamping units	DNMG150408-M3	0,8	12,7	15,5	4,76	5,15	55,0	0,0	■	■	■	■								DNMG432-M3	0.031	0.500	0.610	0.187	0.203													Workpiece materials	DNMG150408-M5	0,8	12,7	15,5	4,76	5,15	55,0	0,0	■	■	■	■								DNMG432-M5	0.031	0.500	0.610	0.187	0.203													Accessories and Spare parts	DNMG150408-M6	0,8	12,7	15,5	4,76	5,15	55,0	0,0			■	■								DNMG432-M6	0.031	0.500	0.610	0.187	0.203													Workpiece materials	DNMG150408-MF3	0,8	12,7	15,5	4,76	5,15	55,0	0,0							■					DNMG432-MF3	0.031	0.500	0.610	0.187	0.203													Workpiece materials	DNMG150408-MF4	0,8	12,7	15,5	4,76	5,15	55,0	0,0				■								DNMG432-MF4	0.031	0.500	0.610	0.187	0.203																																																															
Mini-Shaft™	DNMU110412-M5	1,2	9,525	11,6	4,76	3,81	55,0	0,0		■									DNMU333-M5	0.047	0.375	0.457	0.187	0.150												Grooving	DNMG150402-M1	0,2	12,7	15,5	4,76	5,15	55,0	0,0												DNGP430.5F-M1	0.008	0.500	0.610	0.187	0.203													Parting-off	DNMG150404-M1	0,4	12,7	15,5	4,76	5,15	55,0	0,0												DNGP431F-M1	0.016	0.500	0.610	0.187	0.203													Adapters Clamping units	DNMG150404-M1	0,4	12,7	15,5	4,76	5,15	55,0	0,0	■	■										DNMP431-M1	0.016	0.500	0.610	0.187	0.203													Workpiece materials	DNMG150404-M3	0,4	12,7	15,5	4,76	5,15	55,0	0,0	■	■	■	■								DNMG431-M3	0.016	0.500	0.610	0.187	0.203													Accessories and Spare parts	DNMG150404-M5	0,4	12,7	15,5	4,76	5,15	55,0	0,0					■							DNMG431-M5	0.016	0.500	0.610	0.187	0.203													Adapters Clamping units	DNMG150404-MF1	0,4	12,7	15,5	4,76	5,15	55,0	0,0						■						DNMP431-MF1	0.016	0.500	0.610	0.187	0.203													Workpiece materials	DNMG150404-MF2	0,4	12,7	15,5	4,76	5,15	55,0	0,0	■	■	■	■								DNMG431-MF2	0.016	0.500	0.610	0.187	0.203													Accessories and Spare parts	DNMG150404-MF3	0,4	12,7	15,5	4,76	5,15	55,0	0,0				■								DNMG431-MF3	0.016	0.500	0.610	0.187	0.203													Workpiece materials	DNMG150404-MF4	0,4	12,7	15,5	4,762	5,15	55,0	0,0							■	■				DNMG431-MF4	0.016	0.500	0.610	0.187	0.203													Adapters Clamping units	DNMG150408-M1	0,8	12,7	15,5	4,76	5,15	55,0	0,0												DNGP432F-M1	0.031	0.500	0.610	0.187	0.203													Workpiece materials	DNMG150408-MF1	0,8	12,7	15,5	4,76	5,15	55,0	0,0												DNGM432-MF1	0.031	0.500	0.610	0.187	0.203													Workpiece materials	DNMA150408	0,8	12,7	15,5	4,76	5,15	55,0	0,0												DNMA432	0.031	0.500	0.610	0.187	0.203													Adapters Clamping units	DNMG150408-M3	0,8	12,7	15,5	4,76	5,15	55,0	0,0	■	■	■	■								DNMG432-M3	0.031	0.500	0.610	0.187	0.203													Workpiece materials	DNMG150408-M5	0,8	12,7	15,5	4,76	5,15	55,0	0,0	■	■	■	■								DNMG432-M5	0.031	0.500	0.610	0.187	0.203													Accessories and Spare parts	DNMG150408-M6	0,8	12,7	15,5	4,76	5,15	55,0	0,0			■	■								DNMG432-M6	0.031	0.500	0.610	0.187	0.203													Workpiece materials	DNMG150408-MF3	0,8	12,7	15,5	4,76	5,15	55,0	0,0							■					DNMG432-MF3	0.031	0.500	0.610	0.187	0.203													Workpiece materials	DNMG150408-MF4	0,8	12,7	15,5	4,76	5,15	55,0	0,0				■								DNMG432-MF4	0.031	0.500	0.610	0.187	0.203																																																																																	
	DNMU333-M5	0.047	0.375	0.457	0.187	0.150												Grooving	DNMG150402-M1	0,2	12,7	15,5	4,76	5,15	55,0	0,0												DNGP430.5F-M1	0.008	0.500	0.610	0.187	0.203													Parting-off	DNMG150404-M1	0,4	12,7	15,5	4,76	5,15	55,0	0,0												DNGP431F-M1	0.016	0.500	0.610	0.187	0.203													Adapters Clamping units	DNMG150404-M1	0,4	12,7	15,5	4,76	5,15	55,0	0,0	■	■										DNMP431-M1	0.016	0.500	0.610	0.187	0.203													Workpiece materials	DNMG150404-M3	0,4	12,7	15,5	4,76	5,15	55,0	0,0	■	■	■	■								DNMG431-M3	0.016	0.500	0.610	0.187	0.203													Accessories and Spare parts	DNMG150404-M5	0,4	12,7	15,5	4,76	5,15	55,0	0,0					■							DNMG431-M5	0.016	0.500	0.610	0.187	0.203													Adapters Clamping units	DNMG150404-MF1	0,4	12,7	15,5	4,76	5,15	55,0	0,0						■						DNMP431-MF1	0.016	0.500	0.610	0.187	0.203													Workpiece materials	DNMG150404-MF2	0,4	12,7	15,5	4,76	5,15	55,0	0,0	■	■	■	■								DNMG431-MF2	0.016	0.500	0.610	0.187	0.203													Accessories and Spare parts	DNMG150404-MF3	0,4	12,7	15,5	4,76	5,15	55,0	0,0				■								DNMG431-MF3	0.016	0.500	0.610	0.187	0.203													Workpiece materials	DNMG150404-MF4	0,4	12,7	15,5	4,762	5,15	55,0	0,0							■	■				DNMG431-MF4	0.016	0.500	0.610	0.187	0.203													Adapters Clamping units	DNMG150408-M1	0,8	12,7	15,5	4,76	5,15	55,0	0,0												DNGP432F-M1	0.031	0.500	0.610	0.187	0.203													Workpiece materials	DNMG150408-MF1	0,8	12,7	15,5	4,76	5,15	55,0	0,0												DNGM432-MF1	0.031	0.500	0.610	0.187	0.203													Workpiece materials	DNMA150408	0,8	12,7	15,5	4,76	5,15	55,0	0,0												DNMA432	0.031	0.500	0.610	0.187	0.203													Adapters Clamping units	DNMG150408-M3	0,8	12,7	15,5	4,76	5,15	55,0	0,0	■	■	■	■								DNMG432-M3	0.031	0.500	0.610	0.187	0.203													Workpiece materials	DNMG150408-M5	0,8	12,7	15,5	4,76	5,15	55,0	0,0	■	■	■	■								DNMG432-M5	0.031	0.500	0.610	0.187	0.203													Accessories and Spare parts	DNMG150408-M6	0,8	12,7	15,5	4,76	5,15	55,0	0,0			■	■								DNMG432-M6	0.031	0.500	0.610	0.187	0.203													Workpiece materials	DNMG150408-MF3	0,8	12,7	15,5	4,76	5,15	55,0	0,0							■					DNMG432-MF3	0.031	0.500	0.610	0.187	0.203													Workpiece materials	DNMG150408-MF4	0,8	12,7	15,5	4,76	5,15	55,0	0,0				■								DNMG432-MF4	0.031	0.500	0.610	0.187	0.203																																																																																																			
Grooving	DNMG150402-M1	0,2	12,7	15,5	4,76	5,15	55,0	0,0												DNGP430.5F-M1	0.008	0.500	0.610	0.187	0.203													Parting-off	DNMG150404-M1	0,4	12,7	15,5	4,76	5,15	55,0	0,0												DNGP431F-M1	0.016	0.500	0.610	0.187	0.203													Adapters Clamping units	DNMG150404-M1	0,4	12,7	15,5	4,76	5,15	55,0	0,0	■	■										DNMP431-M1	0.016	0.500	0.610	0.187	0.203													Workpiece materials	DNMG150404-M3	0,4	12,7	15,5	4,76	5,15	55,0	0,0	■	■	■	■								DNMG431-M3	0.016	0.500	0.610	0.187	0.203													Accessories and Spare parts	DNMG150404-M5	0,4	12,7	15,5	4,76	5,15	55,0	0,0					■							DNMG431-M5	0.016	0.500	0.610	0.187	0.203													Adapters Clamping units	DNMG150404-MF1	0,4	12,7	15,5	4,76	5,15	55,0	0,0						■						DNMP431-MF1	0.016	0.500	0.610	0.187	0.203													Workpiece materials	DNMG150404-MF2	0,4	12,7	15,5	4,76	5,15	55,0	0,0	■	■	■	■								DNMG431-MF2	0.016	0.500	0.610	0.187	0.203													Accessories and Spare parts	DNMG150404-MF3	0,4	12,7	15,5	4,76	5,15	55,0	0,0				■								DNMG431-MF3	0.016	0.500	0.610	0.187	0.203													Workpiece materials	DNMG150404-MF4	0,4	12,7	15,5	4,762	5,15	55,0	0,0							■	■				DNMG431-MF4	0.016	0.500	0.610	0.187	0.203													Adapters Clamping units	DNMG150408-M1	0,8	12,7	15,5	4,76	5,15	55,0	0,0												DNGP432F-M1	0.031	0.500	0.610	0.187	0.203													Workpiece materials	DNMG150408-MF1	0,8	12,7	15,5	4,76	5,15	55,0	0,0												DNGM432-MF1	0.031	0.500	0.610	0.187	0.203													Workpiece materials	DNMA150408	0,8	12,7	15,5	4,76	5,15	55,0	0,0												DNMA432	0.031	0.500	0.610	0.187	0.203													Adapters Clamping units	DNMG150408-M3	0,8	12,7	15,5	4,76	5,15	55,0	0,0	■	■	■	■								DNMG432-M3	0.031	0.500	0.610	0.187	0.203													Workpiece materials	DNMG150408-M5	0,8	12,7	15,5	4,76	5,15	55,0	0,0	■	■	■	■								DNMG432-M5	0.031	0.500	0.610	0.187	0.203													Accessories and Spare parts	DNMG150408-M6	0,8	12,7	15,5	4,76	5,15	55,0	0,0			■	■								DNMG432-M6	0.031	0.500	0.610	0.187	0.203													Workpiece materials	DNMG150408-MF3	0,8	12,7	15,5	4,76	5,15	55,0	0,0							■					DNMG432-MF3	0.031	0.500	0.610	0.187	0.203													Workpiece materials	DNMG150408-MF4	0,8	12,7	15,5	4,76	5,15	55,0	0,0				■								DNMG432-MF4	0.031	0.500	0.610	0.187	0.203																																																																																																																					
	DNGP430.5F-M1	0.008	0.500	0.610	0.187	0.203													Parting-off	DNMG150404-M1	0,4	12,7	15,5	4,76	5,15	55,0	0,0												DNGP431F-M1	0.016	0.500	0.610	0.187	0.203													Adapters Clamping units	DNMG150404-M1	0,4	12,7	15,5	4,76	5,15	55,0	0,0	■	■										DNMP431-M1	0.016	0.500	0.610	0.187	0.203													Workpiece materials	DNMG150404-M3	0,4	12,7	15,5	4,76	5,15	55,0	0,0	■	■	■	■								DNMG431-M3	0.016	0.500	0.610	0.187	0.203													Accessories and Spare parts	DNMG150404-M5	0,4	12,7	15,5	4,76	5,15	55,0	0,0					■							DNMG431-M5	0.016	0.500	0.610	0.187	0.203													Adapters Clamping units	DNMG150404-MF1	0,4	12,7	15,5	4,76	5,15	55,0	0,0						■						DNMP431-MF1	0.016	0.500	0.610	0.187	0.203													Workpiece materials	DNMG150404-MF2	0,4	12,7	15,5	4,76	5,15	55,0	0,0	■	■	■	■								DNMG431-MF2	0.016	0.500	0.610	0.187	0.203													Accessories and Spare parts	DNMG150404-MF3	0,4	12,7	15,5	4,76	5,15	55,0	0,0				■								DNMG431-MF3	0.016	0.500	0.610	0.187	0.203													Workpiece materials	DNMG150404-MF4	0,4	12,7	15,5	4,762	5,15	55,0	0,0							■	■				DNMG431-MF4	0.016	0.500	0.610	0.187	0.203													Adapters Clamping units	DNMG150408-M1	0,8	12,7	15,5	4,76	5,15	55,0	0,0												DNGP432F-M1	0.031	0.500	0.610	0.187	0.203													Workpiece materials	DNMG150408-MF1	0,8	12,7	15,5	4,76	5,15	55,0	0,0												DNGM432-MF1	0.031	0.500	0.610	0.187	0.203													Workpiece materials	DNMA150408	0,8	12,7	15,5	4,76	5,15	55,0	0,0												DNMA432	0.031	0.500	0.610	0.187	0.203													Adapters Clamping units	DNMG150408-M3	0,8	12,7	15,5	4,76	5,15	55,0	0,0	■	■	■	■								DNMG432-M3	0.031	0.500	0.610	0.187	0.203													Workpiece materials	DNMG150408-M5	0,8	12,7	15,5	4,76	5,15	55,0	0,0	■	■	■	■								DNMG432-M5	0.031	0.500	0.610	0.187	0.203													Accessories and Spare parts	DNMG150408-M6	0,8	12,7	15,5	4,76	5,15	55,0	0,0			■	■								DNMG432-M6	0.031	0.500	0.610	0.187	0.203													Workpiece materials	DNMG150408-MF3	0,8	12,7	15,5	4,76	5,15	55,0	0,0							■					DNMG432-MF3	0.031	0.500	0.610	0.187	0.203													Workpiece materials	DNMG150408-MF4	0,8	12,7	15,5	4,76	5,15	55,0	0,0				■								DNMG432-MF4	0.031	0.500	0.610	0.187	0.203																																																																																																																																								
Parting-off	DNMG150404-M1	0,4	12,7	15,5	4,76	5,15	55,0	0,0												DNGP431F-M1	0.016	0.500	0.610	0.187	0.203													Adapters Clamping units	DNMG150404-M1	0,4	12,7	15,5	4,76	5,15	55,0	0,0	■	■										DNMP431-M1	0.016	0.500	0.610	0.187	0.203													Workpiece materials	DNMG150404-M3	0,4	12,7	15,5	4,76	5,15	55,0	0,0	■	■	■	■								DNMG431-M3	0.016	0.500	0.610	0.187	0.203													Accessories and Spare parts	DNMG150404-M5	0,4	12,7	15,5	4,76	5,15	55,0	0,0					■							DNMG431-M5	0.016	0.500	0.610	0.187	0.203													Adapters Clamping units	DNMG150404-MF1	0,4	12,7	15,5	4,76	5,15	55,0	0,0						■						DNMP431-MF1	0.016	0.500	0.610	0.187	0.203													Workpiece materials	DNMG150404-MF2	0,4	12,7	15,5	4,76	5,15	55,0	0,0	■	■	■	■								DNMG431-MF2	0.016	0.500	0.610	0.187	0.203													Accessories and Spare parts	DNMG150404-MF3	0,4	12,7	15,5	4,76	5,15	55,0	0,0				■								DNMG431-MF3	0.016	0.500	0.610	0.187	0.203													Workpiece materials	DNMG150404-MF4	0,4	12,7	15,5	4,762	5,15	55,0	0,0							■	■				DNMG431-MF4	0.016	0.500	0.610	0.187	0.203													Adapters Clamping units	DNMG150408-M1	0,8	12,7	15,5	4,76	5,15	55,0	0,0												DNGP432F-M1	0.031	0.500	0.610	0.187	0.203													Workpiece materials	DNMG150408-MF1	0,8	12,7	15,5	4,76	5,15	55,0	0,0												DNGM432-MF1	0.031	0.500	0.610	0.187	0.203													Workpiece materials	DNMA150408	0,8	12,7	15,5	4,76	5,15	55,0	0,0												DNMA432	0.031	0.500	0.610	0.187	0.203													Adapters Clamping units	DNMG150408-M3	0,8	12,7	15,5	4,76	5,15	55,0	0,0	■	■	■	■								DNMG432-M3	0.031	0.500	0.610	0.187	0.203													Workpiece materials	DNMG150408-M5	0,8	12,7	15,5	4,76	5,15	55,0	0,0	■	■	■	■								DNMG432-M5	0.031	0.500	0.610	0.187	0.203													Accessories and Spare parts	DNMG150408-M6	0,8	12,7	15,5	4,76	5,15	55,0	0,0			■	■								DNMG432-M6	0.031	0.500	0.610	0.187	0.203													Workpiece materials	DNMG150408-MF3	0,8	12,7	15,5	4,76	5,15	55,0	0,0							■					DNMG432-MF3	0.031	0.500	0.610	0.187	0.203													Workpiece materials	DNMG150408-MF4	0,8	12,7	15,5	4,76	5,15	55,0	0,0				■								DNMG432-MF4	0.031	0.500	0.610	0.187	0.203																																																																																																																																																											
	DNGP431F-M1	0.016	0.500	0.610	0.187	0.203													Adapters Clamping units	DNMG150404-M1	0,4	12,7	15,5	4,76	5,15	55,0	0,0	■	■										DNMP431-M1	0.016	0.500	0.610	0.187	0.203													Workpiece materials	DNMG150404-M3	0,4	12,7	15,5	4,76	5,15	55,0	0,0	■	■	■	■								DNMG431-M3	0.016	0.500	0.610	0.187	0.203													Accessories and Spare parts	DNMG150404-M5	0,4	12,7	15,5	4,76	5,15	55,0	0,0					■							DNMG431-M5	0.016	0.500	0.610	0.187	0.203													Adapters Clamping units	DNMG150404-MF1	0,4	12,7	15,5	4,76	5,15	55,0	0,0						■						DNMP431-MF1	0.016	0.500	0.610	0.187	0.203													Workpiece materials	DNMG150404-MF2	0,4	12,7	15,5	4,76	5,15	55,0	0,0	■	■	■	■								DNMG431-MF2	0.016	0.500	0.610	0.187	0.203													Accessories and Spare parts	DNMG150404-MF3	0,4	12,7	15,5	4,76	5,15	55,0	0,0				■								DNMG431-MF3	0.016	0.500	0.610	0.187	0.203													Workpiece materials	DNMG150404-MF4	0,4	12,7	15,5	4,762	5,15	55,0	0,0							■	■				DNMG431-MF4	0.016	0.500	0.610	0.187	0.203													Adapters Clamping units	DNMG150408-M1	0,8	12,7	15,5	4,76	5,15	55,0	0,0												DNGP432F-M1	0.031	0.500	0.610	0.187	0.203													Workpiece materials	DNMG150408-MF1	0,8	12,7	15,5	4,76	5,15	55,0	0,0												DNGM432-MF1	0.031	0.500	0.610	0.187	0.203													Workpiece materials	DNMA150408	0,8	12,7	15,5	4,76	5,15	55,0	0,0												DNMA432	0.031	0.500	0.610	0.187	0.203													Adapters Clamping units	DNMG150408-M3	0,8	12,7	15,5	4,76	5,15	55,0	0,0	■	■	■	■								DNMG432-M3	0.031	0.500	0.610	0.187	0.203													Workpiece materials	DNMG150408-M5	0,8	12,7	15,5	4,76	5,15	55,0	0,0	■	■	■	■								DNMG432-M5	0.031	0.500	0.610	0.187	0.203													Accessories and Spare parts	DNMG150408-M6	0,8	12,7	15,5	4,76	5,15	55,0	0,0			■	■								DNMG432-M6	0.031	0.500	0.610	0.187	0.203													Workpiece materials	DNMG150408-MF3	0,8	12,7	15,5	4,76	5,15	55,0	0,0							■					DNMG432-MF3	0.031	0.500	0.610	0.187	0.203													Workpiece materials	DNMG150408-MF4	0,8	12,7	15,5	4,76	5,15	55,0	0,0				■								DNMG432-MF4	0.031	0.500	0.610	0.187	0.203																																																																																																																																																																														
Adapters Clamping units	DNMG150404-M1	0,4	12,7	15,5	4,76	5,15	55,0	0,0	■	■										DNMP431-M1	0.016	0.500	0.610	0.187	0.203													Workpiece materials	DNMG150404-M3	0,4	12,7	15,5	4,76	5,15	55,0	0,0	■	■	■	■								DNMG431-M3	0.016	0.500	0.610	0.187	0.203													Accessories and Spare parts	DNMG150404-M5	0,4	12,7	15,5	4,76	5,15	55,0	0,0					■							DNMG431-M5	0.016	0.500	0.610	0.187	0.203													Adapters Clamping units	DNMG150404-MF1	0,4	12,7	15,5	4,76	5,15	55,0	0,0						■						DNMP431-MF1	0.016	0.500	0.610	0.187	0.203													Workpiece materials	DNMG150404-MF2	0,4	12,7	15,5	4,76	5,15	55,0	0,0	■	■	■	■								DNMG431-MF2	0.016	0.500	0.610	0.187	0.203													Accessories and Spare parts	DNMG150404-MF3	0,4	12,7	15,5	4,76	5,15	55,0	0,0				■								DNMG431-MF3	0.016	0.500	0.610	0.187	0.203													Workpiece materials	DNMG150404-MF4	0,4	12,7	15,5	4,762	5,15	55,0	0,0							■	■				DNMG431-MF4	0.016	0.500	0.610	0.187	0.203													Adapters Clamping units	DNMG150408-M1	0,8	12,7	15,5	4,76	5,15	55,0	0,0												DNGP432F-M1	0.031	0.500	0.610	0.187	0.203													Workpiece materials	DNMG150408-MF1	0,8	12,7	15,5	4,76	5,15	55,0	0,0												DNGM432-MF1	0.031	0.500	0.610	0.187	0.203													Workpiece materials	DNMA150408	0,8	12,7	15,5	4,76	5,15	55,0	0,0												DNMA432	0.031	0.500	0.610	0.187	0.203													Adapters Clamping units	DNMG150408-M3	0,8	12,7	15,5	4,76	5,15	55,0	0,0	■	■	■	■								DNMG432-M3	0.031	0.500	0.610	0.187	0.203													Workpiece materials	DNMG150408-M5	0,8	12,7	15,5	4,76	5,15	55,0	0,0	■	■	■	■								DNMG432-M5	0.031	0.500	0.610	0.187	0.203													Accessories and Spare parts	DNMG150408-M6	0,8	12,7	15,5	4,76	5,15	55,0	0,0			■	■								DNMG432-M6	0.031	0.500	0.610	0.187	0.203													Workpiece materials	DNMG150408-MF3	0,8	12,7	15,5	4,76	5,15	55,0	0,0							■					DNMG432-MF3	0.031	0.500	0.610	0.187	0.203													Workpiece materials	DNMG150408-MF4	0,8	12,7	15,5	4,76	5,15	55,0	0,0				■								DNMG432-MF4	0.031	0.500	0.610	0.187	0.203																																																																																																																																																																																																	
	DNMP431-M1	0.016	0.500	0.610	0.187	0.203													Workpiece materials	DNMG150404-M3	0,4	12,7	15,5	4,76	5,15	55,0	0,0	■	■	■	■								DNMG431-M3	0.016	0.500	0.610	0.187	0.203													Accessories and Spare parts	DNMG150404-M5	0,4	12,7	15,5	4,76	5,15	55,0	0,0					■							DNMG431-M5	0.016	0.500	0.610	0.187	0.203													Adapters Clamping units	DNMG150404-MF1	0,4	12,7	15,5	4,76	5,15	55,0	0,0						■						DNMP431-MF1	0.016	0.500	0.610	0.187	0.203													Workpiece materials	DNMG150404-MF2	0,4	12,7	15,5	4,76	5,15	55,0	0,0	■	■	■	■								DNMG431-MF2	0.016	0.500	0.610	0.187	0.203													Accessories and Spare parts	DNMG150404-MF3	0,4	12,7	15,5	4,76	5,15	55,0	0,0				■								DNMG431-MF3	0.016	0.500	0.610	0.187	0.203													Workpiece materials	DNMG150404-MF4	0,4	12,7	15,5	4,762	5,15	55,0	0,0							■	■				DNMG431-MF4	0.016	0.500	0.610	0.187	0.203													Adapters Clamping units	DNMG150408-M1	0,8	12,7	15,5	4,76	5,15	55,0	0,0												DNGP432F-M1	0.031	0.500	0.610	0.187	0.203													Workpiece materials	DNMG150408-MF1	0,8	12,7	15,5	4,76	5,15	55,0	0,0												DNGM432-MF1	0.031	0.500	0.610	0.187	0.203													Workpiece materials	DNMA150408	0,8	12,7	15,5	4,76	5,15	55,0	0,0												DNMA432	0.031	0.500	0.610	0.187	0.203													Adapters Clamping units	DNMG150408-M3	0,8	12,7	15,5	4,76	5,15	55,0	0,0	■	■	■	■								DNMG432-M3	0.031	0.500	0.610	0.187	0.203													Workpiece materials	DNMG150408-M5	0,8	12,7	15,5	4,76	5,15	55,0	0,0	■	■	■	■								DNMG432-M5	0.031	0.500	0.610	0.187	0.203													Accessories and Spare parts	DNMG150408-M6	0,8	12,7	15,5	4,76	5,15	55,0	0,0			■	■								DNMG432-M6	0.031	0.500	0.610	0.187	0.203													Workpiece materials	DNMG150408-MF3	0,8	12,7	15,5	4,76	5,15	55,0	0,0							■					DNMG432-MF3	0.031	0.500	0.610	0.187	0.203													Workpiece materials	DNMG150408-MF4	0,8	12,7	15,5	4,76	5,15	55,0	0,0				■								DNMG432-MF4	0.031	0.500	0.610	0.187	0.203																																																																																																																																																																																																																				
Workpiece materials	DNMG150404-M3	0,4	12,7	15,5	4,76	5,15	55,0	0,0	■	■	■	■								DNMG431-M3	0.016	0.500	0.610	0.187	0.203													Accessories and Spare parts	DNMG150404-M5	0,4	12,7	15,5	4,76	5,15	55,0	0,0					■							DNMG431-M5	0.016	0.500	0.610	0.187	0.203													Adapters Clamping units	DNMG150404-MF1	0,4	12,7	15,5	4,76	5,15	55,0	0,0						■						DNMP431-MF1	0.016	0.500	0.610	0.187	0.203													Workpiece materials	DNMG150404-MF2	0,4	12,7	15,5	4,76	5,15	55,0	0,0	■	■	■	■								DNMG431-MF2	0.016	0.500	0.610	0.187	0.203													Accessories and Spare parts	DNMG150404-MF3	0,4	12,7	15,5	4,76	5,15	55,0	0,0				■								DNMG431-MF3	0.016	0.500	0.610	0.187	0.203													Workpiece materials	DNMG150404-MF4	0,4	12,7	15,5	4,762	5,15	55,0	0,0							■	■				DNMG431-MF4	0.016	0.500	0.610	0.187	0.203													Adapters Clamping units	DNMG150408-M1	0,8	12,7	15,5	4,76	5,15	55,0	0,0												DNGP432F-M1	0.031	0.500	0.610	0.187	0.203													Workpiece materials	DNMG150408-MF1	0,8	12,7	15,5	4,76	5,15	55,0	0,0												DNGM432-MF1	0.031	0.500	0.610	0.187	0.203													Workpiece materials	DNMA150408	0,8	12,7	15,5	4,76	5,15	55,0	0,0												DNMA432	0.031	0.500	0.610	0.187	0.203													Adapters Clamping units	DNMG150408-M3	0,8	12,7	15,5	4,76	5,15	55,0	0,0	■	■	■	■								DNMG432-M3	0.031	0.500	0.610	0.187	0.203													Workpiece materials	DNMG150408-M5	0,8	12,7	15,5	4,76	5,15	55,0	0,0	■	■	■	■								DNMG432-M5	0.031	0.500	0.610	0.187	0.203													Accessories and Spare parts	DNMG150408-M6	0,8	12,7	15,5	4,76	5,15	55,0	0,0			■	■								DNMG432-M6	0.031	0.500	0.610	0.187	0.203													Workpiece materials	DNMG150408-MF3	0,8	12,7	15,5	4,76	5,15	55,0	0,0							■					DNMG432-MF3	0.031	0.500	0.610	0.187	0.203													Workpiece materials	DNMG150408-MF4	0,8	12,7	15,5	4,76	5,15	55,0	0,0				■								DNMG432-MF4	0.031	0.500	0.610	0.187	0.203																																																																																																																																																																																																																																							
	DNMG431-M3	0.016	0.500	0.610	0.187	0.203													Accessories and Spare parts	DNMG150404-M5	0,4	12,7	15,5	4,76	5,15	55,0	0,0					■							DNMG431-M5	0.016	0.500	0.610	0.187	0.203													Adapters Clamping units	DNMG150404-MF1	0,4	12,7	15,5	4,76	5,15	55,0	0,0						■						DNMP431-MF1	0.016	0.500	0.610	0.187	0.203													Workpiece materials	DNMG150404-MF2	0,4	12,7	15,5	4,76	5,15	55,0	0,0	■	■	■	■								DNMG431-MF2	0.016	0.500	0.610	0.187	0.203													Accessories and Spare parts	DNMG150404-MF3	0,4	12,7	15,5	4,76	5,15	55,0	0,0				■								DNMG431-MF3	0.016	0.500	0.610	0.187	0.203													Workpiece materials	DNMG150404-MF4	0,4	12,7	15,5	4,762	5,15	55,0	0,0							■	■				DNMG431-MF4	0.016	0.500	0.610	0.187	0.203													Adapters Clamping units	DNMG150408-M1	0,8	12,7	15,5	4,76	5,15	55,0	0,0												DNGP432F-M1	0.031	0.500	0.610	0.187	0.203													Workpiece materials	DNMG150408-MF1	0,8	12,7	15,5	4,76	5,15	55,0	0,0												DNGM432-MF1	0.031	0.500	0.610	0.187	0.203													Workpiece materials	DNMA150408	0,8	12,7	15,5	4,76	5,15	55,0	0,0												DNMA432	0.031	0.500	0.610	0.187	0.203													Adapters Clamping units	DNMG150408-M3	0,8	12,7	15,5	4,76	5,15	55,0	0,0	■	■	■	■								DNMG432-M3	0.031	0.500	0.610	0.187	0.203													Workpiece materials	DNMG150408-M5	0,8	12,7	15,5	4,76	5,15	55,0	0,0	■	■	■	■								DNMG432-M5	0.031	0.500	0.610	0.187	0.203													Accessories and Spare parts	DNMG150408-M6	0,8	12,7	15,5	4,76	5,15	55,0	0,0			■	■								DNMG432-M6	0.031	0.500	0.610	0.187	0.203													Workpiece materials	DNMG150408-MF3	0,8	12,7	15,5	4,76	5,15	55,0	0,0							■					DNMG432-MF3	0.031	0.500	0.610	0.187	0.203													Workpiece materials	DNMG150408-MF4	0,8	12,7	15,5	4,76	5,15	55,0	0,0				■								DNMG432-MF4	0.031	0.500	0.610	0.187	0.203																																																																																																																																																																																																																																																										
Accessories and Spare parts	DNMG150404-M5	0,4	12,7	15,5	4,76	5,15	55,0	0,0					■							DNMG431-M5	0.016	0.500	0.610	0.187	0.203													Adapters Clamping units	DNMG150404-MF1	0,4	12,7	15,5	4,76	5,15	55,0	0,0						■						DNMP431-MF1	0.016	0.500	0.610	0.187	0.203													Workpiece materials	DNMG150404-MF2	0,4	12,7	15,5	4,76	5,15	55,0	0,0	■	■	■	■								DNMG431-MF2	0.016	0.500	0.610	0.187	0.203													Accessories and Spare parts	DNMG150404-MF3	0,4	12,7	15,5	4,76	5,15	55,0	0,0				■								DNMG431-MF3	0.016	0.500	0.610	0.187	0.203													Workpiece materials	DNMG150404-MF4	0,4	12,7	15,5	4,762	5,15	55,0	0,0							■	■				DNMG431-MF4	0.016	0.500	0.610	0.187	0.203													Adapters Clamping units	DNMG150408-M1	0,8	12,7	15,5	4,76	5,15	55,0	0,0												DNGP432F-M1	0.031	0.500	0.610	0.187	0.203													Workpiece materials	DNMG150408-MF1	0,8	12,7	15,5	4,76	5,15	55,0	0,0												DNGM432-MF1	0.031	0.500	0.610	0.187	0.203													Workpiece materials	DNMA150408	0,8	12,7	15,5	4,76	5,15	55,0	0,0												DNMA432	0.031	0.500	0.610	0.187	0.203													Adapters Clamping units	DNMG150408-M3	0,8	12,7	15,5	4,76	5,15	55,0	0,0	■	■	■	■								DNMG432-M3	0.031	0.500	0.610	0.187	0.203													Workpiece materials	DNMG150408-M5	0,8	12,7	15,5	4,76	5,15	55,0	0,0	■	■	■	■								DNMG432-M5	0.031	0.500	0.610	0.187	0.203													Accessories and Spare parts	DNMG150408-M6	0,8	12,7	15,5	4,76	5,15	55,0	0,0			■	■								DNMG432-M6	0.031	0.500	0.610	0.187	0.203													Workpiece materials	DNMG150408-MF3	0,8	12,7	15,5	4,76	5,15	55,0	0,0							■					DNMG432-MF3	0.031	0.500	0.610	0.187	0.203													Workpiece materials	DNMG150408-MF4	0,8	12,7	15,5	4,76	5,15	55,0	0,0				■								DNMG432-MF4	0.031	0.500	0.610	0.187	0.203																																																																																																																																																																																																																																																																													
	DNMG431-M5	0.016	0.500	0.610	0.187	0.203													Adapters Clamping units	DNMG150404-MF1	0,4	12,7	15,5	4,76	5,15	55,0	0,0						■						DNMP431-MF1	0.016	0.500	0.610	0.187	0.203													Workpiece materials	DNMG150404-MF2	0,4	12,7	15,5	4,76	5,15	55,0	0,0	■	■	■	■								DNMG431-MF2	0.016	0.500	0.610	0.187	0.203													Accessories and Spare parts	DNMG150404-MF3	0,4	12,7	15,5	4,76	5,15	55,0	0,0				■								DNMG431-MF3	0.016	0.500	0.610	0.187	0.203													Workpiece materials	DNMG150404-MF4	0,4	12,7	15,5	4,762	5,15	55,0	0,0							■	■				DNMG431-MF4	0.016	0.500	0.610	0.187	0.203													Adapters Clamping units	DNMG150408-M1	0,8	12,7	15,5	4,76	5,15	55,0	0,0												DNGP432F-M1	0.031	0.500	0.610	0.187	0.203													Workpiece materials	DNMG150408-MF1	0,8	12,7	15,5	4,76	5,15	55,0	0,0												DNGM432-MF1	0.031	0.500	0.610	0.187	0.203													Workpiece materials	DNMA150408	0,8	12,7	15,5	4,76	5,15	55,0	0,0												DNMA432	0.031	0.500	0.610	0.187	0.203													Adapters Clamping units	DNMG150408-M3	0,8	12,7	15,5	4,76	5,15	55,0	0,0	■	■	■	■								DNMG432-M3	0.031	0.500	0.610	0.187	0.203													Workpiece materials	DNMG150408-M5	0,8	12,7	15,5	4,76	5,15	55,0	0,0	■	■	■	■								DNMG432-M5	0.031	0.500	0.610	0.187	0.203													Accessories and Spare parts	DNMG150408-M6	0,8	12,7	15,5	4,76	5,15	55,0	0,0			■	■								DNMG432-M6	0.031	0.500	0.610	0.187	0.203													Workpiece materials	DNMG150408-MF3	0,8	12,7	15,5	4,76	5,15	55,0	0,0							■					DNMG432-MF3	0.031	0.500	0.610	0.187	0.203													Workpiece materials	DNMG150408-MF4	0,8	12,7	15,5	4,76	5,15	55,0	0,0				■								DNMG432-MF4	0.031	0.500	0.610	0.187	0.203																																																																																																																																																																																																																																																																																																
Adapters Clamping units	DNMG150404-MF1	0,4	12,7	15,5	4,76	5,15	55,0	0,0						■						DNMP431-MF1	0.016	0.500	0.610	0.187	0.203													Workpiece materials	DNMG150404-MF2	0,4	12,7	15,5	4,76	5,15	55,0	0,0	■	■	■	■								DNMG431-MF2	0.016	0.500	0.610	0.187	0.203													Accessories and Spare parts	DNMG150404-MF3	0,4	12,7	15,5	4,76	5,15	55,0	0,0				■								DNMG431-MF3	0.016	0.500	0.610	0.187	0.203													Workpiece materials	DNMG150404-MF4	0,4	12,7	15,5	4,762	5,15	55,0	0,0							■	■				DNMG431-MF4	0.016	0.500	0.610	0.187	0.203													Adapters Clamping units	DNMG150408-M1	0,8	12,7	15,5	4,76	5,15	55,0	0,0												DNGP432F-M1	0.031	0.500	0.610	0.187	0.203													Workpiece materials	DNMG150408-MF1	0,8	12,7	15,5	4,76	5,15	55,0	0,0												DNGM432-MF1	0.031	0.500	0.610	0.187	0.203													Workpiece materials	DNMA150408	0,8	12,7	15,5	4,76	5,15	55,0	0,0												DNMA432	0.031	0.500	0.610	0.187	0.203													Adapters Clamping units	DNMG150408-M3	0,8	12,7	15,5	4,76	5,15	55,0	0,0	■	■	■	■								DNMG432-M3	0.031	0.500	0.610	0.187	0.203													Workpiece materials	DNMG150408-M5	0,8	12,7	15,5	4,76	5,15	55,0	0,0	■	■	■	■								DNMG432-M5	0.031	0.500	0.610	0.187	0.203													Accessories and Spare parts	DNMG150408-M6	0,8	12,7	15,5	4,76	5,15	55,0	0,0			■	■								DNMG432-M6	0.031	0.500	0.610	0.187	0.203													Workpiece materials	DNMG150408-MF3	0,8	12,7	15,5	4,76	5,15	55,0	0,0							■					DNMG432-MF3	0.031	0.500	0.610	0.187	0.203													Workpiece materials	DNMG150408-MF4	0,8	12,7	15,5	4,76	5,15	55,0	0,0				■								DNMG432-MF4	0.031	0.500	0.610	0.187	0.203																																																																																																																																																																																																																																																																																																																			
	DNMP431-MF1	0.016	0.500	0.610	0.187	0.203													Workpiece materials	DNMG150404-MF2	0,4	12,7	15,5	4,76	5,15	55,0	0,0	■	■	■	■								DNMG431-MF2	0.016	0.500	0.610	0.187	0.203													Accessories and Spare parts	DNMG150404-MF3	0,4	12,7	15,5	4,76	5,15	55,0	0,0				■								DNMG431-MF3	0.016	0.500	0.610	0.187	0.203													Workpiece materials	DNMG150404-MF4	0,4	12,7	15,5	4,762	5,15	55,0	0,0							■	■				DNMG431-MF4	0.016	0.500	0.610	0.187	0.203													Adapters Clamping units	DNMG150408-M1	0,8	12,7	15,5	4,76	5,15	55,0	0,0												DNGP432F-M1	0.031	0.500	0.610	0.187	0.203													Workpiece materials	DNMG150408-MF1	0,8	12,7	15,5	4,76	5,15	55,0	0,0												DNGM432-MF1	0.031	0.500	0.610	0.187	0.203													Workpiece materials	DNMA150408	0,8	12,7	15,5	4,76	5,15	55,0	0,0												DNMA432	0.031	0.500	0.610	0.187	0.203													Adapters Clamping units	DNMG150408-M3	0,8	12,7	15,5	4,76	5,15	55,0	0,0	■	■	■	■								DNMG432-M3	0.031	0.500	0.610	0.187	0.203													Workpiece materials	DNMG150408-M5	0,8	12,7	15,5	4,76	5,15	55,0	0,0	■	■	■	■								DNMG432-M5	0.031	0.500	0.610	0.187	0.203													Accessories and Spare parts	DNMG150408-M6	0,8	12,7	15,5	4,76	5,15	55,0	0,0			■	■								DNMG432-M6	0.031	0.500	0.610	0.187	0.203													Workpiece materials	DNMG150408-MF3	0,8	12,7	15,5	4,76	5,15	55,0	0,0							■					DNMG432-MF3	0.031	0.500	0.610	0.187	0.203													Workpiece materials	DNMG150408-MF4	0,8	12,7	15,5	4,76	5,15	55,0	0,0				■								DNMG432-MF4	0.031	0.500	0.610	0.187	0.203																																																																																																																																																																																																																																																																																																																																						
Workpiece materials	DNMG150404-MF2	0,4	12,7	15,5	4,76	5,15	55,0	0,0	■	■	■	■								DNMG431-MF2	0.016	0.500	0.610	0.187	0.203													Accessories and Spare parts	DNMG150404-MF3	0,4	12,7	15,5	4,76	5,15	55,0	0,0				■								DNMG431-MF3	0.016	0.500	0.610	0.187	0.203													Workpiece materials	DNMG150404-MF4	0,4	12,7	15,5	4,762	5,15	55,0	0,0							■	■				DNMG431-MF4	0.016	0.500	0.610	0.187	0.203													Adapters Clamping units	DNMG150408-M1	0,8	12,7	15,5	4,76	5,15	55,0	0,0												DNGP432F-M1	0.031	0.500	0.610	0.187	0.203													Workpiece materials	DNMG150408-MF1	0,8	12,7	15,5	4,76	5,15	55,0	0,0												DNGM432-MF1	0.031	0.500	0.610	0.187	0.203													Workpiece materials	DNMA150408	0,8	12,7	15,5	4,76	5,15	55,0	0,0												DNMA432	0.031	0.500	0.610	0.187	0.203													Adapters Clamping units	DNMG150408-M3	0,8	12,7	15,5	4,76	5,15	55,0	0,0	■	■	■	■								DNMG432-M3	0.031	0.500	0.610	0.187	0.203													Workpiece materials	DNMG150408-M5	0,8	12,7	15,5	4,76	5,15	55,0	0,0	■	■	■	■								DNMG432-M5	0.031	0.500	0.610	0.187	0.203													Accessories and Spare parts	DNMG150408-M6	0,8	12,7	15,5	4,76	5,15	55,0	0,0			■	■								DNMG432-M6	0.031	0.500	0.610	0.187	0.203													Workpiece materials	DNMG150408-MF3	0,8	12,7	15,5	4,76	5,15	55,0	0,0							■					DNMG432-MF3	0.031	0.500	0.610	0.187	0.203													Workpiece materials	DNMG150408-MF4	0,8	12,7	15,5	4,76	5,15	55,0	0,0				■								DNMG432-MF4	0.031	0.500	0.610	0.187	0.203																																																																																																																																																																																																																																																																																																																																																									
	DNMG431-MF2	0.016	0.500	0.610	0.187	0.203													Accessories and Spare parts	DNMG150404-MF3	0,4	12,7	15,5	4,76	5,15	55,0	0,0				■								DNMG431-MF3	0.016	0.500	0.610	0.187	0.203													Workpiece materials	DNMG150404-MF4	0,4	12,7	15,5	4,762	5,15	55,0	0,0							■	■				DNMG431-MF4	0.016	0.500	0.610	0.187	0.203													Adapters Clamping units	DNMG150408-M1	0,8	12,7	15,5	4,76	5,15	55,0	0,0												DNGP432F-M1	0.031	0.500	0.610	0.187	0.203													Workpiece materials	DNMG150408-MF1	0,8	12,7	15,5	4,76	5,15	55,0	0,0												DNGM432-MF1	0.031	0.500	0.610	0.187	0.203													Workpiece materials	DNMA150408	0,8	12,7	15,5	4,76	5,15	55,0	0,0												DNMA432	0.031	0.500	0.610	0.187	0.203													Adapters Clamping units	DNMG150408-M3	0,8	12,7	15,5	4,76	5,15	55,0	0,0	■	■	■	■								DNMG432-M3	0.031	0.500	0.610	0.187	0.203													Workpiece materials	DNMG150408-M5	0,8	12,7	15,5	4,76	5,15	55,0	0,0	■	■	■	■								DNMG432-M5	0.031	0.500	0.610	0.187	0.203													Accessories and Spare parts	DNMG150408-M6	0,8	12,7	15,5	4,76	5,15	55,0	0,0			■	■								DNMG432-M6	0.031	0.500	0.610	0.187	0.203													Workpiece materials	DNMG150408-MF3	0,8	12,7	15,5	4,76	5,15	55,0	0,0							■					DNMG432-MF3	0.031	0.500	0.610	0.187	0.203													Workpiece materials	DNMG150408-MF4	0,8	12,7	15,5	4,76	5,15	55,0	0,0				■								DNMG432-MF4	0.031	0.500	0.610	0.187	0.203																																																																																																																																																																																																																																																																																																																																																																												
Accessories and Spare parts	DNMG150404-MF3	0,4	12,7	15,5	4,76	5,15	55,0	0,0				■								DNMG431-MF3	0.016	0.500	0.610	0.187	0.203													Workpiece materials	DNMG150404-MF4	0,4	12,7	15,5	4,762	5,15	55,0	0,0							■	■				DNMG431-MF4	0.016	0.500	0.610	0.187	0.203													Adapters Clamping units	DNMG150408-M1	0,8	12,7	15,5	4,76	5,15	55,0	0,0												DNGP432F-M1	0.031	0.500	0.610	0.187	0.203													Workpiece materials	DNMG150408-MF1	0,8	12,7	15,5	4,76	5,15	55,0	0,0												DNGM432-MF1	0.031	0.500	0.610	0.187	0.203													Workpiece materials	DNMA150408	0,8	12,7	15,5	4,76	5,15	55,0	0,0												DNMA432	0.031	0.500	0.610	0.187	0.203													Adapters Clamping units	DNMG150408-M3	0,8	12,7	15,5	4,76	5,15	55,0	0,0	■	■	■	■								DNMG432-M3	0.031	0.500	0.610	0.187	0.203													Workpiece materials	DNMG150408-M5	0,8	12,7	15,5	4,76	5,15	55,0	0,0	■	■	■	■								DNMG432-M5	0.031	0.500	0.610	0.187	0.203													Accessories and Spare parts	DNMG150408-M6	0,8	12,7	15,5	4,76	5,15	55,0	0,0			■	■								DNMG432-M6	0.031	0.500	0.610	0.187	0.203													Workpiece materials	DNMG150408-MF3	0,8	12,7	15,5	4,76	5,15	55,0	0,0							■					DNMG432-MF3	0.031	0.500	0.610	0.187	0.203													Workpiece materials	DNMG150408-MF4	0,8	12,7	15,5	4,76	5,15	55,0	0,0				■								DNMG432-MF4	0.031	0.500	0.610	0.187	0.203																																																																																																																																																																																																																																																																																																																																																																																															
	DNMG431-MF3	0.016	0.500	0.610	0.187	0.203													Workpiece materials	DNMG150404-MF4	0,4	12,7	15,5	4,762	5,15	55,0	0,0							■	■				DNMG431-MF4	0.016	0.500	0.610	0.187	0.203													Adapters Clamping units	DNMG150408-M1	0,8	12,7	15,5	4,76	5,15	55,0	0,0												DNGP432F-M1	0.031	0.500	0.610	0.187	0.203													Workpiece materials	DNMG150408-MF1	0,8	12,7	15,5	4,76	5,15	55,0	0,0												DNGM432-MF1	0.031	0.500	0.610	0.187	0.203													Workpiece materials	DNMA150408	0,8	12,7	15,5	4,76	5,15	55,0	0,0												DNMA432	0.031	0.500	0.610	0.187	0.203													Adapters Clamping units	DNMG150408-M3	0,8	12,7	15,5	4,76	5,15	55,0	0,0	■	■	■	■								DNMG432-M3	0.031	0.500	0.610	0.187	0.203													Workpiece materials	DNMG150408-M5	0,8	12,7	15,5	4,76	5,15	55,0	0,0	■	■	■	■								DNMG432-M5	0.031	0.500	0.610	0.187	0.203													Accessories and Spare parts	DNMG150408-M6	0,8	12,7	15,5	4,76	5,15	55,0	0,0			■	■								DNMG432-M6	0.031	0.500	0.610	0.187	0.203													Workpiece materials	DNMG150408-MF3	0,8	12,7	15,5	4,76	5,15	55,0	0,0							■					DNMG432-MF3	0.031	0.500	0.610	0.187	0.203													Workpiece materials	DNMG150408-MF4	0,8	12,7	15,5	4,76	5,15	55,0	0,0				■								DNMG432-MF4	0.031	0.500	0.610	0.187	0.203																																																																																																																																																																																																																																																																																																																																																																																																																		
Workpiece materials	DNMG150404-MF4	0,4	12,7	15,5	4,762	5,15	55,0	0,0							■	■				DNMG431-MF4	0.016	0.500	0.610	0.187	0.203													Adapters Clamping units	DNMG150408-M1	0,8	12,7	15,5	4,76	5,15	55,0	0,0												DNGP432F-M1	0.031	0.500	0.610	0.187	0.203													Workpiece materials	DNMG150408-MF1	0,8	12,7	15,5	4,76	5,15	55,0	0,0												DNGM432-MF1	0.031	0.500	0.610	0.187	0.203													Workpiece materials	DNMA150408	0,8	12,7	15,5	4,76	5,15	55,0	0,0												DNMA432	0.031	0.500	0.610	0.187	0.203													Adapters Clamping units	DNMG150408-M3	0,8	12,7	15,5	4,76	5,15	55,0	0,0	■	■	■	■								DNMG432-M3	0.031	0.500	0.610	0.187	0.203													Workpiece materials	DNMG150408-M5	0,8	12,7	15,5	4,76	5,15	55,0	0,0	■	■	■	■								DNMG432-M5	0.031	0.500	0.610	0.187	0.203													Accessories and Spare parts	DNMG150408-M6	0,8	12,7	15,5	4,76	5,15	55,0	0,0			■	■								DNMG432-M6	0.031	0.500	0.610	0.187	0.203													Workpiece materials	DNMG150408-MF3	0,8	12,7	15,5	4,76	5,15	55,0	0,0							■					DNMG432-MF3	0.031	0.500	0.610	0.187	0.203													Workpiece materials	DNMG150408-MF4	0,8	12,7	15,5	4,76	5,15	55,0	0,0				■								DNMG432-MF4	0.031	0.500	0.610	0.187	0.203																																																																																																																																																																																																																																																																																																																																																																																																																																					
	DNMG431-MF4	0.016	0.500	0.610	0.187	0.203													Adapters Clamping units	DNMG150408-M1	0,8	12,7	15,5	4,76	5,15	55,0	0,0												DNGP432F-M1	0.031	0.500	0.610	0.187	0.203													Workpiece materials	DNMG150408-MF1	0,8	12,7	15,5	4,76	5,15	55,0	0,0												DNGM432-MF1	0.031	0.500	0.610	0.187	0.203													Workpiece materials	DNMA150408	0,8	12,7	15,5	4,76	5,15	55,0	0,0												DNMA432	0.031	0.500	0.610	0.187	0.203													Adapters Clamping units	DNMG150408-M3	0,8	12,7	15,5	4,76	5,15	55,0	0,0	■	■	■	■								DNMG432-M3	0.031	0.500	0.610	0.187	0.203													Workpiece materials	DNMG150408-M5	0,8	12,7	15,5	4,76	5,15	55,0	0,0	■	■	■	■								DNMG432-M5	0.031	0.500	0.610	0.187	0.203													Accessories and Spare parts	DNMG150408-M6	0,8	12,7	15,5	4,76	5,15	55,0	0,0			■	■								DNMG432-M6	0.031	0.500	0.610	0.187	0.203													Workpiece materials	DNMG150408-MF3	0,8	12,7	15,5	4,76	5,15	55,0	0,0							■					DNMG432-MF3	0.031	0.500	0.610	0.187	0.203													Workpiece materials	DNMG150408-MF4	0,8	12,7	15,5	4,76	5,15	55,0	0,0				■								DNMG432-MF4	0.031	0.500	0.610	0.187	0.203																																																																																																																																																																																																																																																																																																																																																																																																																																																								
Adapters Clamping units	DNMG150408-M1	0,8	12,7	15,5	4,76	5,15	55,0	0,0												DNGP432F-M1	0.031	0.500	0.610	0.187	0.203													Workpiece materials	DNMG150408-MF1	0,8	12,7	15,5	4,76	5,15	55,0	0,0												DNGM432-MF1	0.031	0.500	0.610	0.187	0.203													Workpiece materials	DNMA150408	0,8	12,7	15,5	4,76	5,15	55,0	0,0												DNMA432	0.031	0.500	0.610	0.187	0.203													Adapters Clamping units	DNMG150408-M3	0,8	12,7	15,5	4,76	5,15	55,0	0,0	■	■	■	■								DNMG432-M3	0.031	0.500	0.610	0.187	0.203													Workpiece materials	DNMG150408-M5	0,8	12,7	15,5	4,76	5,15	55,0	0,0	■	■	■	■								DNMG432-M5	0.031	0.500	0.610	0.187	0.203													Accessories and Spare parts	DNMG150408-M6	0,8	12,7	15,5	4,76	5,15	55,0	0,0			■	■								DNMG432-M6	0.031	0.500	0.610	0.187	0.203													Workpiece materials	DNMG150408-MF3	0,8	12,7	15,5	4,76	5,15	55,0	0,0							■					DNMG432-MF3	0.031	0.500	0.610	0.187	0.203													Workpiece materials	DNMG150408-MF4	0,8	12,7	15,5	4,76	5,15	55,0	0,0				■								DNMG432-MF4	0.031	0.500	0.610	0.187	0.203																																																																																																																																																																																																																																																																																																																																																																																																																																																																											
	DNGP432F-M1	0.031	0.500	0.610	0.187	0.203													Workpiece materials	DNMG150408-MF1	0,8	12,7	15,5	4,76	5,15	55,0	0,0												DNGM432-MF1	0.031	0.500	0.610	0.187	0.203													Workpiece materials	DNMA150408	0,8	12,7	15,5	4,76	5,15	55,0	0,0												DNMA432	0.031	0.500	0.610	0.187	0.203													Adapters Clamping units	DNMG150408-M3	0,8	12,7	15,5	4,76	5,15	55,0	0,0	■	■	■	■								DNMG432-M3	0.031	0.500	0.610	0.187	0.203													Workpiece materials	DNMG150408-M5	0,8	12,7	15,5	4,76	5,15	55,0	0,0	■	■	■	■								DNMG432-M5	0.031	0.500	0.610	0.187	0.203													Accessories and Spare parts	DNMG150408-M6	0,8	12,7	15,5	4,76	5,15	55,0	0,0			■	■								DNMG432-M6	0.031	0.500	0.610	0.187	0.203													Workpiece materials	DNMG150408-MF3	0,8	12,7	15,5	4,76	5,15	55,0	0,0							■					DNMG432-MF3	0.031	0.500	0.610	0.187	0.203													Workpiece materials	DNMG150408-MF4	0,8	12,7	15,5	4,76	5,15	55,0	0,0				■								DNMG432-MF4	0.031	0.500	0.610	0.187	0.203																																																																																																																																																																																																																																																																																																																																																																																																																																																																																														
Workpiece materials	DNMG150408-MF1	0,8	12,7	15,5	4,76	5,15	55,0	0,0												DNGM432-MF1	0.031	0.500	0.610	0.187	0.203													Workpiece materials	DNMA150408	0,8	12,7	15,5	4,76	5,15	55,0	0,0												DNMA432	0.031	0.500	0.610	0.187	0.203													Adapters Clamping units	DNMG150408-M3	0,8	12,7	15,5	4,76	5,15	55,0	0,0	■	■	■	■								DNMG432-M3	0.031	0.500	0.610	0.187	0.203													Workpiece materials	DNMG150408-M5	0,8	12,7	15,5	4,76	5,15	55,0	0,0	■	■	■	■								DNMG432-M5	0.031	0.500	0.610	0.187	0.203													Accessories and Spare parts	DNMG150408-M6	0,8	12,7	15,5	4,76	5,15	55,0	0,0			■	■								DNMG432-M6	0.031	0.500	0.610	0.187	0.203													Workpiece materials	DNMG150408-MF3	0,8	12,7	15,5	4,76	5,15	55,0	0,0							■					DNMG432-MF3	0.031	0.500	0.610	0.187	0.203													Workpiece materials	DNMG150408-MF4	0,8	12,7	15,5	4,76	5,15	55,0	0,0				■								DNMG432-MF4	0.031	0.500	0.610	0.187	0.203																																																																																																																																																																																																																																																																																																																																																																																																																																																																																																																	
	DNGM432-MF1	0.031	0.500	0.610	0.187	0.203													Workpiece materials	DNMA150408	0,8	12,7	15,5	4,76	5,15	55,0	0,0												DNMA432	0.031	0.500	0.610	0.187	0.203													Adapters Clamping units	DNMG150408-M3	0,8	12,7	15,5	4,76	5,15	55,0	0,0	■	■	■	■								DNMG432-M3	0.031	0.500	0.610	0.187	0.203													Workpiece materials	DNMG150408-M5	0,8	12,7	15,5	4,76	5,15	55,0	0,0	■	■	■	■								DNMG432-M5	0.031	0.500	0.610	0.187	0.203													Accessories and Spare parts	DNMG150408-M6	0,8	12,7	15,5	4,76	5,15	55,0	0,0			■	■								DNMG432-M6	0.031	0.500	0.610	0.187	0.203													Workpiece materials	DNMG150408-MF3	0,8	12,7	15,5	4,76	5,15	55,0	0,0							■					DNMG432-MF3	0.031	0.500	0.610	0.187	0.203													Workpiece materials	DNMG150408-MF4	0,8	12,7	15,5	4,76	5,15	55,0	0,0				■								DNMG432-MF4	0.031	0.500	0.610	0.187	0.203																																																																																																																																																																																																																																																																																																																																																																																																																																																																																																																																				
Workpiece materials	DNMA150408	0,8	12,7	15,5	4,76	5,15	55,0	0,0												DNMA432	0.031	0.500	0.610	0.187	0.203													Adapters Clamping units	DNMG150408-M3	0,8	12,7	15,5	4,76	5,15	55,0	0,0	■	■	■	■								DNMG432-M3	0.031	0.500	0.610	0.187	0.203													Workpiece materials	DNMG150408-M5	0,8	12,7	15,5	4,76	5,15	55,0	0,0	■	■	■	■								DNMG432-M5	0.031	0.500	0.610	0.187	0.203													Accessories and Spare parts	DNMG150408-M6	0,8	12,7	15,5	4,76	5,15	55,0	0,0			■	■								DNMG432-M6	0.031	0.500	0.610	0.187	0.203													Workpiece materials	DNMG150408-MF3	0,8	12,7	15,5	4,76	5,15	55,0	0,0							■					DNMG432-MF3	0.031	0.500	0.610	0.187	0.203													Workpiece materials	DNMG150408-MF4	0,8	12,7	15,5	4,76	5,15	55,0	0,0				■								DNMG432-MF4	0.031	0.500	0.610	0.187	0.203																																																																																																																																																																																																																																																																																																																																																																																																																																																																																																																																																							
	DNMA432	0.031	0.500	0.610	0.187	0.203													Adapters Clamping units	DNMG150408-M3	0,8	12,7	15,5	4,76	5,15	55,0	0,0	■	■	■	■								DNMG432-M3	0.031	0.500	0.610	0.187	0.203													Workpiece materials	DNMG150408-M5	0,8	12,7	15,5	4,76	5,15	55,0	0,0	■	■	■	■								DNMG432-M5	0.031	0.500	0.610	0.187	0.203													Accessories and Spare parts	DNMG150408-M6	0,8	12,7	15,5	4,76	5,15	55,0	0,0			■	■								DNMG432-M6	0.031	0.500	0.610	0.187	0.203													Workpiece materials	DNMG150408-MF3	0,8	12,7	15,5	4,76	5,15	55,0	0,0							■					DNMG432-MF3	0.031	0.500	0.610	0.187	0.203													Workpiece materials	DNMG150408-MF4	0,8	12,7	15,5	4,76	5,15	55,0	0,0				■								DNMG432-MF4	0.031	0.500	0.610	0.187	0.203																																																																																																																																																																																																																																																																																																																																																																																																																																																																																																																																																																										
Adapters Clamping units	DNMG150408-M3	0,8	12,7	15,5	4,76	5,15	55,0	0,0	■	■	■	■								DNMG432-M3	0.031	0.500	0.610	0.187	0.203													Workpiece materials	DNMG150408-M5	0,8	12,7	15,5	4,76	5,15	55,0	0,0	■	■	■	■								DNMG432-M5	0.031	0.500	0.610	0.187	0.203													Accessories and Spare parts	DNMG150408-M6	0,8	12,7	15,5	4,76	5,15	55,0	0,0			■	■								DNMG432-M6	0.031	0.500	0.610	0.187	0.203													Workpiece materials	DNMG150408-MF3	0,8	12,7	15,5	4,76	5,15	55,0	0,0							■					DNMG432-MF3	0.031	0.500	0.610	0.187	0.203													Workpiece materials	DNMG150408-MF4	0,8	12,7	15,5	4,76	5,15	55,0	0,0				■								DNMG432-MF4	0.031	0.500	0.610	0.187	0.203																																																																																																																																																																																																																																																																																																																																																																																																																																																																																																																																																																																													
	DNMG432-M3	0.031	0.500	0.610	0.187	0.203													Workpiece materials	DNMG150408-M5	0,8	12,7	15,5	4,76	5,15	55,0	0,0	■	■	■	■								DNMG432-M5	0.031	0.500	0.610	0.187	0.203													Accessories and Spare parts	DNMG150408-M6	0,8	12,7	15,5	4,76	5,15	55,0	0,0			■	■								DNMG432-M6	0.031	0.500	0.610	0.187	0.203													Workpiece materials	DNMG150408-MF3	0,8	12,7	15,5	4,76	5,15	55,0	0,0							■					DNMG432-MF3	0.031	0.500	0.610	0.187	0.203													Workpiece materials	DNMG150408-MF4	0,8	12,7	15,5	4,76	5,15	55,0	0,0				■								DNMG432-MF4	0.031	0.500	0.610	0.187	0.203																																																																																																																																																																																																																																																																																																																																																																																																																																																																																																																																																																																																																
Workpiece materials	DNMG150408-M5	0,8	12,7	15,5	4,76	5,15	55,0	0,0	■	■	■	■								DNMG432-M5	0.031	0.500	0.610	0.187	0.203													Accessories and Spare parts	DNMG150408-M6	0,8	12,7	15,5	4,76	5,15	55,0	0,0			■	■								DNMG432-M6	0.031	0.500	0.610	0.187	0.203													Workpiece materials	DNMG150408-MF3	0,8	12,7	15,5	4,76	5,15	55,0	0,0							■					DNMG432-MF3	0.031	0.500	0.610	0.187	0.203													Workpiece materials	DNMG150408-MF4	0,8	12,7	15,5	4,76	5,15	55,0	0,0				■								DNMG432-MF4	0.031	0.500	0.610	0.187	0.203																																																																																																																																																																																																																																																																																																																																																																																																																																																																																																																																																																																																																																			
	DNMG432-M5	0.031	0.500	0.610	0.187	0.203													Accessories and Spare parts	DNMG150408-M6	0,8	12,7	15,5	4,76	5,15	55,0	0,0			■	■								DNMG432-M6	0.031	0.500	0.610	0.187	0.203													Workpiece materials	DNMG150408-MF3	0,8	12,7	15,5	4,76	5,15	55,0	0,0							■					DNMG432-MF3	0.031	0.500	0.610	0.187	0.203													Workpiece materials	DNMG150408-MF4	0,8	12,7	15,5	4,76	5,15	55,0	0,0				■								DNMG432-MF4	0.031	0.500	0.610	0.187	0.203																																																																																																																																																																																																																																																																																																																																																																																																																																																																																																																																																																																																																																																						
Accessories and Spare parts	DNMG150408-M6	0,8	12,7	15,5	4,76	5,15	55,0	0,0			■	■								DNMG432-M6	0.031	0.500	0.610	0.187	0.203													Workpiece materials	DNMG150408-MF3	0,8	12,7	15,5	4,76	5,15	55,0	0,0							■					DNMG432-MF3	0.031	0.500	0.610	0.187	0.203													Workpiece materials	DNMG150408-MF4	0,8	12,7	15,5	4,76	5,15	55,0	0,0				■								DNMG432-MF4	0.031	0.500	0.610	0.187	0.203																																																																																																																																																																																																																																																																																																																																																																																																																																																																																																																																																																																																																																																																									
	DNMG432-M6	0.031	0.500	0.610	0.187	0.203													Workpiece materials	DNMG150408-MF3	0,8	12,7	15,5	4,76	5,15	55,0	0,0							■					DNMG432-MF3	0.031	0.500	0.610	0.187	0.203													Workpiece materials	DNMG150408-MF4	0,8	12,7	15,5	4,76	5,15	55,0	0,0				■								DNMG432-MF4	0.031	0.500	0.610	0.187	0.203																																																																																																																																																																																																																																																																																																																																																																																																																																																																																																																																																																																																																																																																																												
Workpiece materials	DNMG150408-MF3	0,8	12,7	15,5	4,76	5,15	55,0	0,0							■					DNMG432-MF3	0.031	0.500	0.610	0.187	0.203													Workpiece materials	DNMG150408-MF4	0,8	12,7	15,5	4,76	5,15	55,0	0,0				■								DNMG432-MF4	0.031	0.500	0.610	0.187	0.203																																																																																																																																																																																																																																																																																																																																																																																																																																																																																																																																																																																																																																																																																																															
	DNMG432-MF3	0.031	0.500	0.610	0.187	0.203													Workpiece materials	DNMG150408-MF4	0,8	12,7	15,5	4,76	5,15	55,0	0,0				■								DNMG432-MF4	0.031	0.500	0.610	0.187	0.203																																																																																																																																																																																																																																																																																																																																																																																																																																																																																																																																																																																																																																																																																																																																		
Workpiece materials	DNMG150408-MF4	0,8	12,7	15,5	4,76	5,15	55,0	0,0				■								DNMG432-MF4	0.031	0.500	0.610	0.187	0.203																																																																																																																																																																																																																																																																																																																																																																																																																																																																																																																																																																																																																																																																																																																																																					
	DNMG432-MF4	0.031	0.500	0.610	0.187	0.203																																																																																																																																																																																																																																																																																																																																																																																																																																																																																																																																																																																																																																																																																																																																																																								

Designation	RE	IC	L	S	D1	EPR [®]	AN [°]	Cemented Carbide and Cermet Grades																			
								Coated												Uncoated				Cermet			
								TP0501	TP1501	TP2501	TP3501	TP25	TP40	TM1501	TM2501	TM3501	TK0501	TK1501	TS2000	TS2050	TS2500	TH1000	TH1500	CP200	CP500	CP600	HX
mm Inch	mm Inch	mm Inch	mm Inch	mm Inch																							
DNMG150408-MF5 DNMG432-MF5	0,8 0.031	12,7 0.500	15,5 0.610	4,76 0.187	5,15 0.203	55,0	0,0		■	■																	
DNMG150408-MR3 DNMG432-MR3	0,8 0.031	12,7 0.500	15,5 0.610	4,76 0.187	5,15 0.203	55,0	0,0						■	■					■	■					■		
DNMG150408-MR4 DNMG432-MR4	0,8 0.031	12,7 0.500	15,5 0.610	4,76 0.187	5,15 0.203	55,0	0,0																		■		
DNMX150408W-M3 DNMX432W-M3	0,8 0.031	12,7 0.500	15,5 0.610	4,762 0.187	5,15 0.203	55,0	0,0		■																		
DNMX150408W-MF4 DNMX432W-MF4	0,8 0.031	12,7 0.500	15,5 0.610	4,76 0.187	5,15 0.203	55,0	0,0						■														
DNMA150412-MR9 DNMA433-MR9	1,2 0.047	12,7 0.500	15,5 0.610	4,76 0.187	5,15 0.203	55,0	0,0																				
DNMG150412-M1 DNMP433-M1	1,2 0.047	12,7 0.500	15,5 0.610	4,76 0.187	5,15 0.203	55,0	0,0																		■		
DNMG150412-M3 DNMG433-M3	1,2 0.047	12,7 0.500	15,5 0.610	4,76 0.187	5,15 0.203	55,0	0,0	■	■	■	■	■															
DNMG150412-M5 DNMG433-M5	1,2 0.047	12,7 0.500	15,5 0.610	4,76 0.187	5,15 0.203	55,0	0,0		■	■	■																
DNMG150412-M6 DNMG433-M6	1,2 0.047	12,7 0.500	15,5 0.610	4,76 0.187	5,15 0.203	55,0	0,0		■	■	■																
DNMG150412-MF2 DNMG433-MF2	1,2 0.047	12,7 0.500	15,5 0.610	4,76 0.187	5,15 0.203	55,0	0,0																				
DNMG150412-MF4 DNMG433-MF4	1,2 0.047	12,7 0.500	15,5 0.610	4,762 0.187	5,15 0.203	55,0	0,0						■	■	■												
DNMG150412-MF5 DNMG433-MF5	1,2 0.047	12,7 0.500	15,5 0.610	4,76 0.187	5,15 0.203	55,0	0,0		■	■																	
DNMG150412-MR3 DNMG433-MR3	1,2 0.047	12,7 0.500	15,5 0.610	4,76 0.187	5,15 0.203	55,0	0,0						■	■						■							
DNMG150412-MR4 DNMG433-MR4	1,2 0.047	12,7 0.500	15,5 0.610	4,76 0.187	5,15 0.203	55,0	0,0																		■		
DNMX150412W-M3 DNMX433W-M3	1,2 0.047	12,7 0.500	15,5 0.610	4,762 0.187	5,15 0.203	55,0	0,0		■																		
DNMG150416-M6 DNMG434-M6	1,6 0.063	12,7 0.500	15,5 0.610	4,76 0.187	5,15 0.203	55,0	0,0																				
DNMG150604-FF1 DNMG441-FF1	0,4 0.016	12,7 0.500	15,5 0.610	6,35 0.250	5,15 0.203	55,0	0,0																			■	
DNMG150604-FF2 DNMG441-FF2	0,4 0.016	12,7 0.500	15,5 0.610	6,35 0.250	5,15 0.203	55,0	0,0		■	■																■	
DNMG150604-M3 DNMG441-M3	0,4 0.016	12,7 0.500	15,5 0.610	6,35 0.250	5,15 0.203	55,0	0,0		■	■	■	■	■														
DNMG150604-M5 DNMG441-M5	0,4 0.016	12,7 0.500	15,5 0.610	6,35 0.250	5,15 0.203	55,0	0,0																				
DNMG150604-MF1 DNMP441-MF1	0,4 0.016	12,7 0.500	15,5 0.610	6,35 0.250	5,15 0.203	55,0	0,0																			■	
DNMG150604-MF2 DNMG441-MF2	0,4 0.016	12,7 0.500	15,5 0.610	6,35 0.250	5,15 0.203	55,0	0,0		■	■	■	■														■	
DNMG150604-MF3 DNMG441-MF3	0,4 0.016	12,7 0.500	15,5 0.610	6,35 0.250	5,15 0.203	55,0	0,0																				
DNMG150604-MF4 DNMG441-MF4	0,4 0.016	12,7 0.500	15,5 0.610	6,35 0.250	5,15 0.203	55,0	0,0																				
DNMG150604L-UX DNMG441L-UX	0,4 0.016	12,7 0.500	15,5 0.610	6,35 0.250	5,16 0.203	55,0	0,0		■	■																	
DNMG150604R-UX DNMG441R-UX	0,4 0.016	12,7 0.500	15,5 0.610	6,35 0.250	5,16 0.203	55,0	0,0		■	■																	
DNGM150608-MF1 DNGM442F-MF1	0,8 0.031	12,7 0.500	15,5 0.610	6,35 0.250	5,15 0.203	55,0	0,0																			■	
DNMA150608 DNMA442	0,8 0.031	12,7 0.500	15,5 0.610	6,35 0.250	5,15 0.203	55,0	0,0																				
DNMG150608-FF2 DNMG442-FF2	0,8 0.031	12,7 0.500	15,5 0.610	6,35 0.250	5,15 0.203	55,0	0,0		■	■	■															■	

General ISO Turning Inserts
Steadyline[®]
MDT
Mini-Shaft[™]
Grooving
Parting-off
X4
Adapters Clamping units
Accessories and Spare parts
Workpiece materials

General ISO Turning Inserts	Cemented Carbide and Cermet Grades																												
	Designation	RE	IC	L	S	D1	EPRS°	AN°	Coated										Uncoated				Cermet						
									TP0601	TP1601	TP2601	TP3601	TP25	TP40	TM1601	TM2601	TM3601	TK0601	TK1601	TS2000	TS2050	TS2600	TH1000	TH1600	CP200	CP500	CP600	HX	KX
mm Inch	mm Inch	mm Inch	mm Inch	mm Inch	mm Inch																								
General ISO Turning Inserts	DNMG150608-M3 DNMG442-M3	0,8 0.031	12,7 0.500	15,5 0.610	6,35 0.250	5,15 0.203	55,0	0,0	■	■	■	■	■	■	■	■	■	■	■	■	■								
	DNMG150608-M5 DNMG442-M5	0,8 0.031	12,7 0.500	15,5 0.610	6,35 0.250	5,15 0.203	55,0	0,0	■	■	■	■	■	■	■	■	■	■	■	■	■								
Steadyline®	DNMG150608-M6 DNMG442-M6	0,8 0.031	12,7 0.500	15,5 0.610	6,35 0.250	5,15 0.203	55,0	0,0		■	■	■									■								
	DNMG150608-MF1 DNMG442-MF1	0,8 0.031	12,7 0.500	15,5 0.610	6,35 0.250	5,15 0.203	55,0	0,0						■	■	■												■	
MDT	DNMG150608-MF2 DNMG442-MF2	0,8 0.031	12,7 0.500	15,5 0.610	6,35 0.250	5,15 0.203	55,0	0,0	■	■	■	■	■														■	■	
	DNMG150608-MF3 DNMG442-MF3	0,8 0.031	12,7 0.500	15,5 0.610	6,35 0.250	5,15 0.203	55,0	0,0				■																	
Mini-Shaft™	DNMG150608-MR3 DNMG442-MR3	0,8 0.031	12,7 0.500	15,5 0.610	6,35 0.250	5,15 0.203	55,0	0,0																				■	
	DNMG150608-MR7 DNMG442-MR7	0,8 0.031	12,7 0.500	15,5 0.610	6,35 0.250	5,15 0.203	55,0	0,0		■																			
Grooving	DNMG150608L-UX DNMG442L-UX	0,8 0.031	12,7 0.500	15,5 0.610	6,35 0.250	5,16 0.203	55,0	0,0	■	■																			
	DNMG150608R-UX DNMG442R-UX	0,8 0.031	12,7 0.500	15,5 0.610	6,35 0.250	5,16 0.203	55,0	0,0	■	■																			
Parting-off	DNMA150612 DNMA443	1,2 0.047	12,7 0.500	15,5 0.610	6,35 0.250	5,15 0.203	55,0	0,0																					
	DNMG150612-M3 DNMG443-M3	1,2 0.047	12,7 0.500	15,5 0.610	6,35 0.250	5,15 0.203	55,0	0,0	■	■	■	■	■	■	■	■	■	■	■	■	■								
Adapters Clamping units	DNMG150612-MF2 DNMG443-MF2	1,2 0.047	12,7 0.500	15,5 0.610	6,35 0.250	5,15 0.203	55,0	0,0	■	■	■	■	■																
	DNMG150612-MF4 DNMG443-MF4	1,2 0.047	12,7 0.500	15,5 0.610	6,35 0.250	5,15 0.203	55,0	0,0																					
Accessories and Spare parts	DNMG150612-MR3 DNMG443-MR3	1,2 0.047	12,7 0.500	15,5 0.610	6,35 0.250	5,15 0.203	55,0	0,0																				■	
	DNMG150612-MR7 DNMG443-MR7	1,2 0.047	12,7 0.500	15,5 0.610	6,35 0.250	5,15 0.203	55,0	0,0	■	■																			
Workpiece materials	DNMG150616-M3 DNMG444-M3	1,6 0.063	12,7 0.500	15,5 0.610	6,35 0.250	5,15 0.203	55,0	0,0		■	■	■																	
	DNMG150616-M5 DNMG444-M5	1,6 0.063	12,7 0.500	15,5 0.610	6,35 0.250	5,15 0.203	55,0	0,0	■	■	■	■																	

Designation	RE	IC	L	S	D1	EPR [®]	AN [°]	Cemented Carbide and Cermet Grades																		
								Coated										Uncoated				Cermet				
								TP0501	TP1501	TP2501	TP3501	TP25	TP40	TM1501	TM2501	TM3501	TK0501	TK1501	TS2000	TS2050	TS2500	TH1000	TH1500	CP200	CP500	CP600
mm Inch	mm Inch	mm Inch	mm Inch	mm Inch																						
DNMG150616-M6 DNMG444-M6	1,6 0.063	12,7 0.500	15,5 0.610	6,35 0.250	5,15 0.203	55,0	0,0		■	■	■															
DNMG150616-MF2 DNMG444-MF2	1,6 0.063	12,7 0.500	15,5 0.610	6,35 0.250	5,15 0.203	55,0	0,0		■		■															
DNMG150616-MF5 DNMG444-MF5	1,6 0.063	12,7 0.500	15,5 0.610	6,35 0.250	5,15 0.203	55,0	0,0				■															
DNMM150616-R4 DNMM444-R4	1,6 0.063	12,7 0.500	15,5 0.610	6,35 0.250	5,15 0.203	55,0	0,0	■	■	■																
DNMM150616-R6 DNMM444-R6	1,6 0.063	12,7 0.500	15,5 0.610	6,35 0.250	5,15 0.203	55,0	0,0						■													
DNMG190608-M5 DNMG542-M5	0,8 0.031	15,875 0.625	19,4 0.764	6,35 0.250	6,35 0.250	55,0	0,0				■	■														
DNMG190612-M5 DNMG543-M6	1,2 0.047	15,875 0.625	19,4 0.764	6,35 0.250	6,35 0.250	55,0	0,0				■															
DNMG190612-MR4 DNMG543-MR4	1,2 0.047	15,875 0.625	19,386 0.763	6,35 0.250	6,35 0.250	55,0	0,0																■			

- General ISO Turning Inserts
- Steadyline[®]
- MDT
- Mini-Shaft[™]
- Grooving
- Parting-off
- X4
- Adapters
Clamping units
- Accessories and
Spare parts
- Workpiece
materials

LNMX

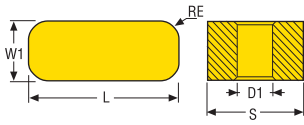

Tolerances:
W1 = ±0,13/0.005
L = ±0,15/0.006
S = ±0,15/0.006
RE = ±0,1/0.004

Please check availability at
www.secotools.com / Seco Online Store

LNMX-MF



LNMX-MR



LNMX-R2



LNMX-RR94



Designation	RE	IC	L	S	D1	EPSR°	AN°	Cemented Carbide and Cermet Grades																			
								Coated												Uncoated				Cermet			
								TP0501	TP1501	TP2501	TP3501	TP25	TP40	TM1501	TM2501	TM3501	TK0501	TK1501	TS2000	TS2050	TS2500	TH1000	TH1500	CP200	CP500	CP600	HX
LNMX191940-MF LNMX191940-MF	4,0 0.157	10,0 0.394	19,05 0.750	19,05 0.750	6,35 0.250	90,0	0,0	■																			
LNMX191940-MR LNMX191940-MR	4,0 0.157	10,0 0.394	19,05 0.750	19,05 0.750	6,35 0.250	90,0	0,0	■	■			■															
LNMX191940-R2 LNMX191940-R2	4,0 0.157	10,0 0.394	19,05 0.750	19,05 0.750	6,35 0.250	90,0	0,0	■	■																		
LNMX191940-RR94 LNMX191940-RR94	4,0 0.157	10,0 0.394	19,05 0.750	19,05 0.750	6,35 0.250	90,0	0,0	■	■			■															
LNMX301940-MF LNMX301940-MF	4,0 0.157	12,0 0.472	30,0 1.181	19,05 0.750	6,35 0.250	90,0	0,0	■	■	■																	
LNMX301940-MR LNMX301940-MR	4,0 0.157	12,0 0.472	30,0 1.181	19,05 0.750	6,35 0.250	90,0	0,0				■																
LNMX301940-R2 LNMX301940-R2	4,0 0.157	12,0 0.472	30,0 1.181	19,05 0.750	6,35 0.250	90,0	0,0	■	■																		
LNMX301940-RR94 LNMX301940-RR94	4,0 0.157	12,0 0.472	30,0 1.181	19,05 0.750	6,35 0.250	90,0	0,0	■																			

General ISO Turning
Inserts

Steadyline®

MDT

Mini-Shaft™

Grooving

Parting-off

X4

Adapters
Clamping units

Accessories and
Spare parts

Workpiece
materials

Please check availability at www.secotools.com / Seco Online Store

Tolerances:
 W1 = ±0,13/0.005
 L = ±0,15/0.006
 S = ±0,15/0.006
 RE = ±0,1/0.004

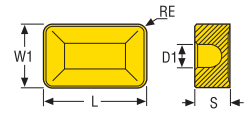

LNMX

LNMX-RR96

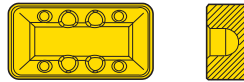

Designation	RE	IC	L	S	D1	EPSR°	AN°	Cemented Carbide and Cermet Grades																			
								Coated										Uncoated		Cermet							
								TP0501	TP1501	TP2501	TP3501	TP25	TP40	TM1501	TM2501	TM3501	TK0501	TK1501	TS2000	TS2050	TS2500	TH1000	TH1500	CP200	CP500	CP600	HX
LNMX401432-RR96	3,2	25,2	40,0	14,0	9,3	90,0	0,0		■	■																	
LNMX401432-RR96	0.126	0.992	1.575	0.551	0.366																						
LNMX501432-RR96	3,2	25,4	50,8	14,0	9,3	90,0	0,0		■																		
LNMX501432-RR96	0.126	1.000	2.000	0.551	0.366																						

General ISO Turning Inserts

Steadyline®

MDT

Mini-Shaft™

Grooving

Parting-off

X4

Adapters
Clamping units

Accessories and
Spare parts

Workpiece
materials

RCGS

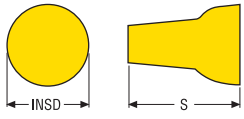

Tolerances:
 INSD = $\pm 0,025/0,001$
 S = $\pm 0,25/0,010$

Please check availability at
www.secotools.com / Seco Online Store

RCGS-46

RCGS-PS

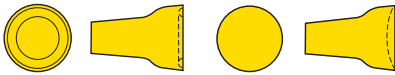

Designation	INSD	S	EPSR°	AN°	Cemented Carbide and Cermet Grades																								
					Coated													Uncoated		Cermet									
	mm <i>Inch</i>	mm <i>Inch</i>			TP0501	TP1501	TP2501	TP3501	TP25	TP40	TM1501	TM2501	TM3501	TK0501	TK1501	TS2000	TS2050	TS2500	TH1000	TH1500	CP200	CP500	CP600	HX	KX	883	890	TP1030	TP1020
RCGS12.7-46 RCGS4-46	12,7 0.500	16,67 0.656		7,0												■	■				■					■	■		
RCGS12.7-PS RCGS4F-PS	12,7 0.500	16,67 0.656		7,0																						■			
RCGS4.76-46 RCGS1.5-46	4,76 0.187	6,35 0.250		7,0												■	■				■					■	■		
RCGS4.76-PS RCGS1.5-PS	4,76 0.187	6,35 0.250		7,0												■					■					■			
RCGS6.35-46 RCGS2-46	6,35 0.250	9,13 0.359		7,0												■	■				■					■	■		
RCGS6.35-PS RCGS2-PS	6,35 0.250	9,13 0.359		7,0												■					■					■	■		
RCGS9.525-46 RCGS3-46	9,525 0.375	13,1 0.516		7,0												■	■				■					■	■		
RCGS9.525-PS RCGS3-PS	9,525 0.375	13,1 0.516		7,0												■					■					■	■		

General ISO Turning Inserts

Steadyline®

MDT

Mini-Shaft™

Grooving

Parting-off

X4

Adapters
Clamping units

Accessories and
Spare parts

Workpiece
materials

Shape of clamping hole differ for RCMM, RCMT and RCMX see www.secotools.com

Please check availability at www.secotools.com / Seco Online Store

RCMM
Tolerances: Size:
INSD = ±0,08/.003 12-19/4-6
INSD = ±0,10/.004 25/8
S = ±0,05/.002

RCMT
Tolerances: Size:
INSD = ±0,05/.002 06-10/2-10
INSD = ±0,08/.003 12/4
INSD = ±0,10/.004 16/16
S = ±0,05/.002 06-10/2-10
S = ±0,13/.005 12-16/4-16

RCMX
Tolerances: Size:
INSD = ±0,08/.003 10-20/10-20
INSD = ±0,10/.004 25-32/25-32
S = ±0,05/.002 10/10
S = ±0,13/.005 12-32/12-32

RCMM, RCMT, RCMX

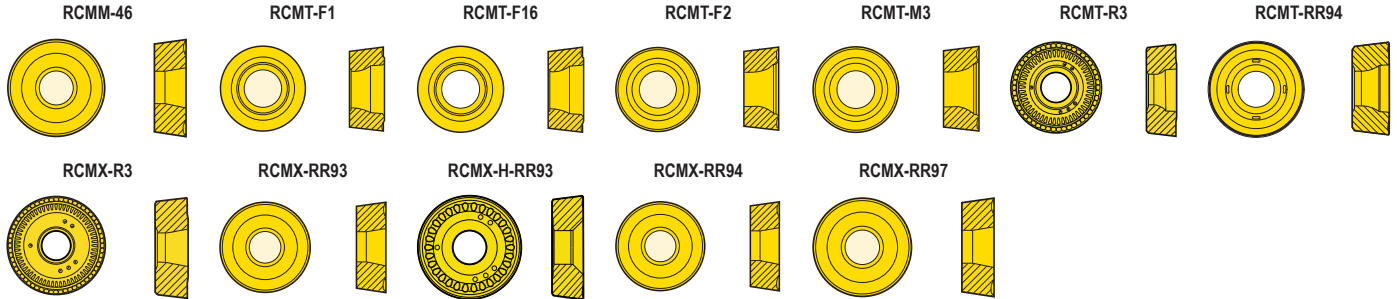
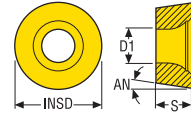

Designation	INSD	S	D1	EPSR°	AN°	Cemented Carbide and Cermet Grades																								
						Coated											Uncoated		Cermet											
						TP0501	TP1501	TP2501	TP3501	TP25	TP40	TM1501	TM2501	TM3501	TK0501	TK1501	TS2000	TS2050	TS2500	TH1000	TH1500	CP200	CP500	CP600	HX	KX	883	890	TP1030	TP1020
mm	mm	mm			mm	mm	mm	mm	mm	mm	mm	mm	mm	mm	mm	mm	mm	mm	mm	mm	mm	mm	mm	mm	mm	mm				
Inch	Inch	Inch				Inch	Inch	Inch	Inch	Inch	Inch	Inch	Inch	Inch	Inch	Inch	Inch	Inch	Inch	Inch	Inch	Inch	Inch	Inch	Inch	Inch	Inch			
RCMT0602M0-F1 RCMT0602M0-F1	6,0 0.236	2,38 0.094	2,9 0.114		7,0			■	■																					
RCMT0602M0-F2 RCMT0602M0-F2	6,0 0.236	2,38 0.094	2,9 0.114		7,0										■															
RCMT0602M0-M3 RCMT0602M0-M3	6,0 0.236	2,38 0.094	2,9 0.114	0,0	7,0			■	■	■																				
RCMT060300-F16 RCMT22-F16	6,35 0.250	3,21 0.126	2,79 0.110		7,0																									
RCMT0803M0-F1 RCMT0803M0-F1	8,0 0.315	3,18 0.125	3,5 0.138	0,0	7,0			■	■	■																				
RCMT0803M0-F2 RCMT0803M0-F2	8,0 0.315	3,18 0.125	3,5 0.138		7,0										■															
RCMT0803M0-M3 RCMT0803M0-M3	8,0 0.315	3,18 0.125	3,5 0.138	0,0	7,0			■	■	■	■				■															
RCMT09T300-F16 RCMT32.5-F16	9,525 0.375	3,97 0.156	3,9 0.154		7,0																									
RCMX100300-RR94 RCMX100300-RR94	10,0 0.394	3,18 0.125	3,6 0.142		7,0																									
RCMT10T3M0-F1 RCMT10T3M0-F1	10,0 0.394	3,97 0.156	4,5 0.177	0,0	7,0			■	■																					
RCMT10T3M0-F2 RCMT10T3M0-F2	10,0 0.394	3,97 0.156	4,5 0.177		7,0										■															
RCMT10T3M0-M3 RCMT10T3M0-M3	10,0 0.394	3,97 0.156	4,5 0.177	0,0	7,0			■	■	■	■				■															
RCMM120400-46 RCMM43-46	12,7 0.500	4,89 0.193	5,16 0.203		7,0																									
RCMT120400-F16 RCMT43-F16	12,7 0.500	4,76 0.187	4,5 0.177		7,0																									
RCMX120400-RR94 RCMX120400-RR94	12,0 0.472	4,76 0.187	4,2 0.165		7,0			■	■																					
RCMT1204M0-F1 RCMT1204M0-F1	12,0 0.472	4,76 0.187	4,5 0.177	0,0	7,0			■	■	■					■															
RCMT1204M0-F2 RCMT1204M0-F2	12,0 0.472	4,76 0.187	4,5 0.177		7,0										■															
RCMT1204M0-M3 RCMT1204M0-M3	12,0 0.472	4,76 0.187	4,5 0.177	0,0	7,0			■	■	■	■				■															
RCMT1204M0-RR94 RCMT1204M0-RR94	12,0 0.472	4,76 0.187	4,5 0.177		7,0																									
RCMX160600-RR94 RCMX160600-RR94	16,0 0.630	6,35 0.250	5,2 0.205		7,0			■	■	■																				

General ISO Turning Inserts
Steadyline®
MDT
Mini-Shaft™
Grooving
Parting-off
X4
Adapters Clamping units
Accessories and Spare parts
Workpiece materials

General ISO Turning Inserts	Designation	INSD mm Inch	S mm Inch	D1 mm Inch	EPRS°	AN°	Cemented Carbide and Cermet Grades																			
							Coated														Uncoated				Cermet	
							TP0601	TP1501	TP2501	TP3501	TP25	TP40	TM1501	TM2501	TM3501	TK0501	TK1501	TS2000	TS2050	TS2500	TH1000	TH1500	CP200	CP500	CP600	HX
RCMT1606M0-F1 RCMT1606M0-F1	16,0 0.630	6,35 0.250	5,6 0.220		7,0	■	■	■	■																	
RCMT1606M0-F2 RCMT1606M0-F2	16,0 0.630	6,35 0.250	5,6 0.220		7,0						■										■					
RCMT1606M0-M3 RCMT1606M0-M3	16,0 0.630	6,35 0.250	5,6 0.220	0,0	7,0	■	■	■	■	■																
RCMM190600-46 RCMM64-46	19,05 0.750	6,35 0.250	7,95 0.313		7,0										■								■			
RCMX200600-R3 RCMX200600-R3	20,0 0.787	6,35 0.250	6,5 0.256		7,0	■	■	■																		
RCMX200600-RR93 RCMX200600-RR93	20,0 0.787	6,35 0.250	6,5 0.256	0,0	7,0	■	■	■			■															
RCMX200600-RR94 RCMX200600-RR94	20,0 0.787	6,35 0.250	6,5 0.256		7,0				■																	
RCMT2006M0-R3 RCMT2006M0-R3	20,0 0.787	6,35 0.250	6,6 0.260		7,0			■						■	■											
RCMM250600-46 RCMM84-46	25,4 1.000	6,35 0.250	7,95 0.313		7,0																		■			
RCMX250700-R3 RCMX250700-R3	25,0 0.984	7,94 0.313	7,2 0.283		7,0	■	■	■																		
RCMX250700-RR93 RCMX250700-RR93	25,0 0.984	7,94 0.313	7,2 0.283	0,0	7,0	■	■	■			■															
RCMX250700-RR94 RCMX250700-RR94	25,0 0.984	7,94 0.313	7,2 0.283		7,0				■																	
RCMX320900-R3 RCMX320900-R3	32,0 1.260	9,52 0.375	9,5 0.374		7,0			■																		
RCMX320900-RR93 RCMX320900-RR93	32,0 1.260	9,52 0.375	9,5 0.374	0,0	7,0	■	■	■			■															
RCMX320900-H-RR93 RCMX320900-H-RR93	32,0 1.260	9,52 0.375	10,4 0.409		7,0	■	■	■																		
RCMX320900-RR94 RCMX320900-RR94	32,0 1.260	9,52 0.375	9,5 0.374		7,0	■		■	■																	
RCMX320900-RR97 RCMX320900-RR97	32,0 1.260	9,52 0.375	9,5 0.374		7,0	■																				

Please check availability at www.secotools.com / Seco Online Store

Tolerances: Size:
 INSD = $\pm 0,08/0.003$ 12/4
 INSD = $\pm 0,10/0.004$ 19/6
 INSD = $\pm 0,13/0.005$ 25/8
 S = $\pm 0,13/0.005$

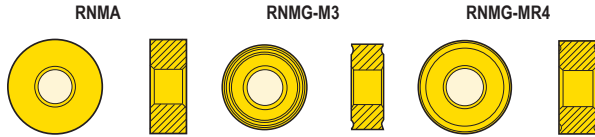
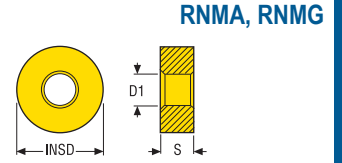

Designation	INSD	S	D1	EPSR°	AN°	Cemented Carbide and Cermet Grades																										
						Coated												Uncoated		Cermet												
	mm <i>Inch</i>	mm <i>Inch</i>	mm <i>Inch</i>			TP0501	TP1501	TP2501	TP3501	TP25	TP40	TM1501	TM2501	TM3501	TK0501	TK1501	TS2000	TS2050	TS2500	TH1000	TH1500	CP200	CP500	CP600	HX	KX	883	890	TP1030	TP1020		
RNMA120400 <i>RNMA43</i>	12,7 <i>0.500</i>	4,76 <i>0.187</i>	5,15 <i>0.203</i>		0,0																											
RNMG120400-M3 <i>RNMG43-M3</i>	12,7 <i>0.500</i>	4,76 <i>0.187</i>	5,15 <i>0.203</i>		0,0		■	■	■																							
RNMG120400-MR4 <i>RNMG43-MR4</i>	12,7 <i>0.500</i>	4,76 <i>0.187</i>	5,15 <i>0.203</i>		0,0															■												
RNMG190600-MR4 <i>RNMG64-MR4</i>	19,05 <i>0.750</i>	6,35 <i>0.250</i>	7,92 <i>0.312</i>		0,0																											
RNMG250900-MR4 <i>RNMG86-MR4</i>	25,4 <i>1.000</i>	9,52 <i>0.375</i>	9,12 <i>0.359</i>		0,0																											

General ISO Turning Inserts

Steadyline®

MDT

Mini-Shaft™

Grooving

Parting-off

X4

Adapters Clamping units

Accessories and Spare parts

Workpiece materials

SCMT

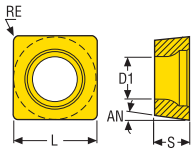

Tolerances: Size:
 L = ±0,05/0.002 06-09/2-3
 L = ±0,08/0.003 12/4
 L = ±0,13/0.005 15-25/5-8
 L = ±0,15/0.006 38/12
 S = ±0,05/0.002 06-09/2-3
 S = ±0,13/0.005 12-25/4-8
 S = ±0,15/0.006 38/12
 RE = ±0,1/0.004

Please check availability at
www.secotools.com / Seco Online Store

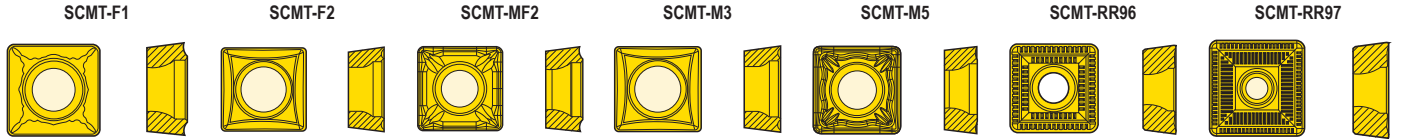

Designation	RE	L	S	D1	EPSR°	AN°	Cemented Carbide and Cermet Grades																				
							Coated												Uncoated		Cermet						
							TP0601	TP1501	TP2501	TP3501	TP25	TP40	TM1501	TM2501	TM3501	TK0501	TK1501	TS2000	TS2050	TS2500	TH1000	TH1500	CP200	CP500	CP600	HX	KX
SCMT060204-F2	0,4	6,35	2,38	2,9	90,0	7,0																					
SCMT21.51-F2	0.016	0.250	0.094	0.114																							
SCMT060204-M3	0,4	6,35	2,38	2,9	90,0	7,0																					
SCMT21.51-M3	0.016	0.250	0.094	0.114																							
SCMT070308-F2	0,8	7,94	3,18	3,5	90,0	7,0																					
SCMT2.522-F2	0.031	0.313	0.125	0.138																							
SCMT070308-M3	0,8	7,94	3,18	3,5	90,0	7,0																					
SCMT2.522-M3	0.031	0.313	0.125	0.138																							
SCMT09T304-F1	0,4	9,52	3,97	4,5	90,0	7,0																					
SCMT32.51-F1	0.016	0.375	0.156	0.177																							
SCMT09T304-F2	0,4	9,52	3,97	4,5	90,0	7,0																					
SCMT32.51-F2	0.016	0.375	0.156	0.177																							
SCMT09T304-M3	0,4	9,52	3,97	4,5	90,0	7,0																					
SCMT32.51-M3	0.016	0.375	0.156	0.177																							
SCMT09T304-MF2	0,4	9,52	3,97	4,5	90,0	7,0																					
SCMT32.51-MF2	0.016	0.375	0.156	0.177																							
SCMT09T308-F1	0,8	9,52	3,97	4,5	90,0	7,0																					
SCMT32.52-F1	0.031	0.375	0.156	0.177																							
SCMT09T308-F2	0,8	9,52	3,97	4,5	90,0	7,0																					
SCMT32.52-F2	0.031	0.375	0.156	0.177																							
SCMT09T308-M3	0,8	9,52	3,97	4,5	90,0	7,0																					
SCMT32.52-M3	0.031	0.375	0.156	0.177																							
SCMT09T308-M5	0,8	9,52	3,97	4,5	90,0	7,0																					
SCMT32.52-M5	0.031	0.375	0.156	0.177																							
SCMT09T308-MF2	0,8	9,52	3,97	4,5	90,0	7,0																					
SCMT32.52-MF2	0.031	0.375	0.156	0.177																							
SCMT09T312-F1	1,2	9,52	3,97	4,5	90,0	7,0																					
SCMT32.53-F1	0.047	0.375	0.156	0.177																							
SCMT09T312-M5	1,2	9,52	3,97	4,5	90,0	7,0																					
SCMT32.53-M5	0.047	0.375	0.156	0.177																							
SCMT09T312-MF2	1,2	9,52	3,97	4,5	90,0	7,0																					
SCMT32.53-MF2	0.047	0.375	0.156	0.177																							
SCMT120408-F1	0,8	12,7	4,76	5,6	90,0	7,0																					
SCMT432-F1	0.031	0.500	0.187	0.220																							
SCMT120408-F2	0,8	12,7	4,76	5,6	90,0	7,0																					
SCMT432-F2	0.031	0.500	0.187	0.220																							
SCMT120408-M3	0,8	12,7	4,76	5,6	90,0	7,0																					
SCMT432-M3	0.031	0.500	0.187	0.220																							
SCMT120408-M5	0,8	12,7	4,76	5,6	90,0	7,0																					
SCMT432-M5	0.031	0.500	0.187	0.220																							
SCMT120408-MF2	0,8	12,7	4,76	5,6	90,0	7,0																					
SCMT432-MF2	0.031	0.500	0.187	0.220																							
SCMT120412-F1	1,2	12,7	4,76	5,6	90,0	7,0																					
SCMT433-F1	0.047	0.500	0.187	0.220																							
SCMT120412-M3	1,2	12,7	4,76	5,6	90,0	7,0																					
SCMT433-M3	0.047	0.500	0.187	0.220																							

Designation	RE	L	S	D1	EPSR°	AN°	Cemented Carbide and Cermet Grades																			
							Coated													Uncoated			Cermet			
							TP0501	TP1501	TP2501	TP3501	TP25	TP40	TM1501	TM2501	TM3501	TK0501	TK1501	TS2000	TS2050	TS2500	TH1000	TH1500	CP200	CP500	CP600	HX
mm Inch	mm Inch	mm Inch	mm Inch																							
SCMT120412-MF2 SCMT433-MF2	1,2 0.047	12,7 0.500	4,76 0.187	5,6 0.220	90,0	7,0																				
SCMT150512-F2 SCMT53.53-F2	1,2 0.047	15,88 0.625	5,56 0.219	8,7 0.343	90,0	7,0																				
SCMT250924-RR97 SCMT866-RR97	2,4 0.094	25,4 1.000	9,52 0.375	8,7 0.343	90,0	7,0	■		■																	
SCMT380932-RR96 SCMT1268-RR96	2,4 0.094	25,4 1.000	9,52 0.375	8,7 0.343	90,0	7,0																				
SCMT380932-RR97 SCMT1268-RR97	3,2 0.126	38,1 1.500	9,52 0.375	8,7 0.343	90,0	7,0	■																			

General ISO Turning
Inserts

Steadyline®

MDT

Mini-Shaft™

Grooving

Parting-off

X4

Adapters
Clamping units

Accessories and
Spare parts

Workpiece
materials

SNMA, SNMG, SNMM

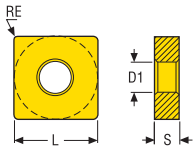

Tolerances: Size:
 L = ±0,05/0.002 09/3
 L = ±0,08/0.003 12/4
 L = ±0,10/0.004 15-19/5-6
 L = ±0,13/0.005 25/8
 S = ±0,13/0.005
 RE = ±0,1/0.004

Please check availability at
www.secotools.com / Seco Online Store

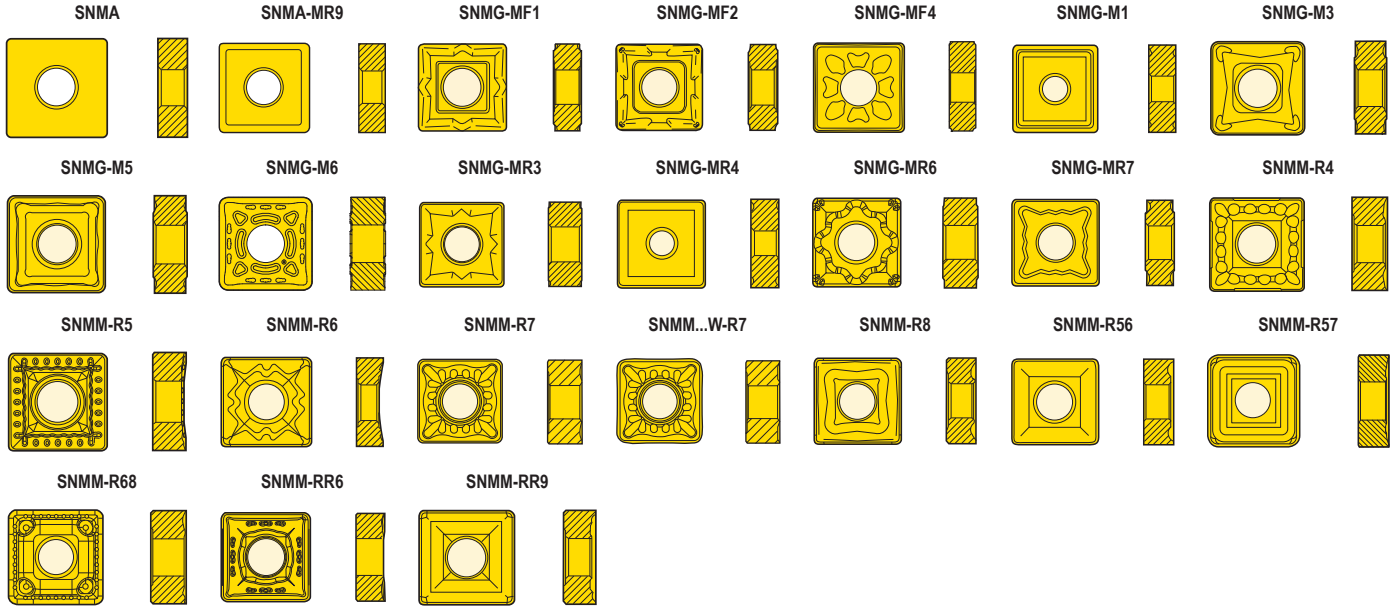

Designation	RE	L	S	D1	EPRS°	AN°	Cemented Carbide and Cermet Grades																										
							Coated												Uncoated				Cermet										
	mm	mm	mm	mm			TP0501	TP1501	TP2501	TP3501	TP25	TP40	TM1501	TM2501	TM3501	TK0501	TK1501	TS2000	TS2050	TS2500	TH1000	TH1500	CP200	CP500	CP600	HX	KX	883	890	TP1030	TP1020		
	Inch	Inch	Inch	Inch																													
SNMG090304-MF2 SNMG321-MF2	0,4 0.016	9,525 0.375	3,18 0.125	3,81 0.150	90,0	0,0			■																								
SNMA090308 SNMA322	0,8 0.031	9,525 0.375	3,18 0.125	3,81 0.150	90,0	0,0										■																	
SNMG090308-M5 SNMG322-M5	0,8 0.031	9,525 0.375	3,18 0.125	3,81 0.150	90,0	0,0			■	■																							
SNMG090308-MF2 SNMG322-MF2	0,8 0.031	9,525 0.375	3,18 0.125	3,81 0.150	90,0	0,0			■	■																							
SNMG120404-M3 SNMG431-M3	0,4 0.016	12,7 0.500	4,76 0.187	5,15 0.203	90,0	0,0			■	■																							
SNMA120408-MR9 SNMA432-MR9	0,8 0.031	12,7 0.500	4,76 0.187	5,15 0.203	90,0	0,0										■	■																
SNMA120408 SNMA432	0,8 0.031	12,7 0.500	4,76 0.187	5,15 0.203	90,0	0,0										■	■																
SNMG120408-M1 SNMP432-M1	0,8 0.031	12,7 0.500	4,76 0.187	5,15 0.203	90,0	0,0																						■					
SNMG120408-M3 SNMG432-M3	0,8 0.031	12,7 0.500	4,76 0.187	5,15 0.203	90,0	0,0		■	■	■	■	■			■		■							■									
SNMG120408-M5 SNMG432-M5	0,8 0.031	12,7 0.500	4,76 0.187	5,15 0.203	90,0	0,0			■	■	■	■	■	■		■	■				■												
SNMG120408-M6 SNMG432-M6	0,8 0.031	12,7 0.500	4,76 0.187	5,15 0.203	90,0	0,0		■	■	■																							
SNMG120408-MF1 SNMP432-MF1	0,8 0.031	12,7 0.500	4,76 0.187	5,15 0.203	90,0	0,0							■		■			■					■	■						■			
SNMG120408-MF2 SNMG432-MF2	0,8 0.031	12,7 0.500	4,76 0.187	5,15 0.203	90,0	0,0		■	■	■	■											■									■		
SNMG120408-MF4 SNMG432-MF4	0,8 0.031	12,7 0.500	4,76 0.187	5,15 0.203	90,0	0,0							■	■	■																		

Designation	RE	L	S	D1	ECSR°	AN°	Cemented Carbide and Cermet Grades																			
							Coated													Uncoated			Cermet			
							TP0501	TP1501	TP2501	TP3501	TP25	TP40	TM1501	TM2501	TM3501	TK0501	TK1501	TS2000	TS2050	TS2500	TH1000	TH1500	CP200	CP500	CP600	HX
mm Inch	mm Inch	mm Inch	mm Inch																							
SNMG120408-MR3 SNMG432-MR3	0,8 0.031	12,7 0.500	4,76 0.187	5,15 0.203	90,0	0,0																				
SNMG120408-MR4 SNMG432-MR4	0,8 0.031	12,7 0.500	4,76 0.187	5,15 0.203	90,0	0,0																				
SNMG120408-MR7 SNMG432-MR7	0,8 0.031	12,7 0.500	4,76 0.187	5,15 0.203	90,0	0,0																				
SNMM120408-R4 SNMM432-R4	0,8 0.031	12,7 0.500	4,76 0.187	5,15 0.203	90,0	0,0																				
SNMM120408-R6 SNMM432-R6	0,8 0.031	12,7 0.500	4,76 0.187	5,15 0.203	90,0	0,0																				
SNMM120408-RR6 SNMM432-RR6	0,8 0.031	12,7 0.500	4,76 0.187	5,15 0.203	90,0	0,0																				
SNMA120412-MR9 SNMA433-MR9	1,2 0.047	12,7 0.500	4,76 0.187	5,15 0.203	90,0	0,0																				
SNMA120412 SNMA433	1,2 0.047	12,7 0.500	4,76 0.187	5,15 0.203	90,0	0,0																				
SNMG120412-M3 SNMG433-M3	1,2 0.047	12,7 0.500	4,76 0.187	5,15 0.203	90,0	0,0																				
SNMG120412-M5 SNMG433-M5	1,2 0.047	12,7 0.500	4,762 0.187	5,15 0.203	90,0	0,0																				
SNMG120412-M6 SNMG433-M6	1,2 0.047	12,7 0.500	4,76 0.187	5,15 0.203	90,0	0,0																				
SNMG120412-MF1 SNMP433-MF1	1,2 0.047	12,7 0.500	4,76 0.187	5,15 0.203	90,0	0,0																				
SNMG120412-MF2 SNMG433-MF2	1,2 0.047	12,7 0.500	4,76 0.187	5,15 0.203	90,0	0,0																				
SNMG120412-MF4 SNMG433-MF4	1,2 0.047	12,7 0.500	4,76 0.187	5,15 0.203	90,0	0,0																				
SNMG120412-MR3 SNMG433-MR3	1,2 0.047	12,7 0.500	4,76 0.187	5,15 0.203	90,0	0,0																				
SNMG120412-MR4 SNMG433-MR4	1,2 0.047	12,7 0.500	4,76 0.187	5,15 0.203	90,0	0,0																				
SNMG120412-MR7 SNMG433-MR7	1,2 0.047	12,7 0.500	4,76 0.187	5,15 0.203	90,0	0,0																				
SNMM120412-R4 SNMM433-R4	1,2 0.047	12,7 0.500	4,76 0.187	5,15 0.203	90,0	0,0																				
SNMM120412-R8 SNMM433-R8	1,2 0.047	12,7 0.500	4,76 0.187	5,15 0.203	90,0	0,0																				
SNMA120416-MR9 SNMA434-MR9	1,6 0.063	12,7 0.500	4,76 0.187	5,15 0.203	90,0	0,0																				
SNMA120416 SNMA434	1,6 0.063	12,7 0.500	4,76 0.187	5,15 0.203	90,0	0,0																				
SNMG120416-M3 SNMG434-M3	1,6 0.063	12,7 0.500	4,76 0.187	5,15 0.203	90,0	0,0																				
SNMG120416-M5 SNMG434-M5	1,6 0.063	12,7 0.500	4,76 0.187	5,15 0.203	90,0	0,0																				
SNMG120416-M6 SNMG434-M6	1,6 0.063	12,7 0.500	4,76 0.187	5,15 0.203	90,0	0,0																				
SNMG120416-MR4 SNMG434-MR4	1,6 0.063	12,7 0.500	4,76 0.187	5,15 0.203	90,0	0,0																				
SNMG120416-MR7 SNMG434-MR7	1,6 0.063	12,7 0.500	4,76 0.187	5,15 0.203	90,0	0,0																				
SNMG150608-M5 SNMG542-M5	0,8 0.031	15,875 0.625	6,35 0.250	6,35 0.250	90,0	0,0																				
SNMA150612 SNMA543	1,2 0.047	15,875 0.625	6,35 0.250	6,35 0.250	90,0	0,0																				
SNMG150612-M1 SNMP543-M1	1,2 0.047	15,875 0.625	6,35 0.250	6,35 0.250	90,0	0,0																				
SNMG150612-M3 SNMG543-M3	1,2 0.047	15,875 0.625	6,35 0.250	6,35 0.250	90,0	0,0																				

General ISO Turning Inserts

Steadyline®

MDT

Mini-Shaft™

Grooving

Parting-off

X4

Adapters
Clamping units

Accessories and
Spare parts

Workpiece
materials

General ISO Turning Inserts	Designation	Cemented Carbide and Cermet Grades						Coated																Uncoated				Cermet								
		RE	L	S	D1	EPSR°	AN°	TP0501	TP1501	TP2501	TP3501	TP25	TP40	TM1501	TM2501	TM3501	TK0501	TK1501	TS2000	TS2050	TS2500	TH1000	TH1500	CP200	CP500	CP600	HX	KX	883	890	TP1030	TP1020				
		mm Inch	mm Inch	mm Inch	mm Inch																															
General ISO Turning Inserts	SNMG150612-M5 SNMG543-M5	1,2 0.047	15,875 0.625	6,35 0.250	6,35 0.250	90,0	0,0		■	■	■	■	■	■																						
	SNMG150612-M6 SNMG543-M6	1,2 0.047	15,875 0.625	6,35 0.250	6,35 0.250	90,0	0,0		■	■	■																									
Steadyline®	SNMG150612-MR4 SNMG543-MR4	1,2 0.047	15,875 0.625	6,35 0.250	6,35 0.250	90,0	0,0													■																
	SNMG150612-MR6 SNMG543-MR6	1,2 0.047	15,875 0.625	6,35 0.250	6,35 0.250	90,0	0,0			■																										
MDT	SNMG150612-MR7 SNMG543-MR7	1,2 0.047	15,875 0.625	6,35 0.250	6,35 0.250	90,0	0,0			■	■							■																		
	SNMM150612-R4 SNMM543-R4	1,2 0.047	15,875 0.625	6,35 0.250	6,35 0.250	90,0	0,0			■	■																									
Mini-Shaft™	SNMA150616-MR9 SNMA544-MR9	1,6 0.063	15,875 0.625	6,35 0.250	6,35 0.250	90,0	0,0										■	■																		
	SNMG150616-M5 SNMG544-M5	1,6 0.063	15,875 0.625	6,35 0.250	6,35 0.250	90,0	0,0	■	■	■	■	■	■	■																						
Grooving	SNMG150616-M6 SNMG544-M6	1,6 0.063	15,875 0.625	6,35 0.250	6,35 0.250	90,0	0,0	■	■	■	■																									
	SNMG150616-MR7 SNMG544-MR7	1,6 0.063	15,875 0.625	6,35 0.250	6,35 0.250	90,0	0,0			■																										
Parting-off	SNMM150616-R4 SNMM544-R4	1,6 0.063	15,875 0.625	6,35 0.250	6,35 0.250	90,0	0,0	■		■	■	■																								
	SNMM150616-RR6 SNMM544-RR6	1,6 0.063	15,875 0.625	6,35 0.250	6,35 0.250	90,0	0,0								■																					
Adapters Clamping units	SNMM150624-R7 SNMM546-R7	2,4 0.094	15,875 0.625	6,35 0.250	6,35 0.250	90,0	0,0			■		■																								
	SNMA190612 SNMA643	1,2 0.047	19,05 0.750	6,35 0.250	7,92 0.312	90,0	0,0											■																		
Accessories and Spare parts	SNMG190612-M3 SNMG643-M3	1,2 0.047	19,05 0.750	6,35 0.250	7,92 0.312	90,0	0,0			■	■																									
	SNMG190612-M5 SNMG643-M5	1,2 0.047	19,05 0.750	6,35 0.250	7,92 0.312	90,0	0,0			■	■	■	■	■	■																					
Workpiece materials	SNMG190612-M6 SNMG643-M6	1,2 0.047	19,05 0.750	6,35 0.250	7,92 0.312	90,0	0,0	■	■	■	■																									
	SNMG190612-MR4 SNMG643-MR4	1,2 0.047	19,05 0.750	6,35 0.250	7,92 0.312	90,0	0,0														■															
Workpiece materials	SNMG190612-MR7 SNMG643-MR7	1,2 0.047	19,05 0.750	6,35 0.250	7,92 0.312	90,0	0,0			■	■	■	■	■	■																					
	SNMM190612-R4 SNMM643-R4	1,2 0.047	19,05 0.750	6,35 0.250	7,92 0.312	90,0	0,0			■	■																									
Workpiece materials	SNMM190612-R6 SNMM643-R6	1,2 0.047	19,05 0.750	6,35 0.250	7,92 0.312	90,0	0,0				■																									
	SNMM190612-R7 SNMM643-R7	1,2 0.047	19,05 0.750	6,35 0.250	7,92 0.312	90,0	0,0			■																										
Workpiece materials	SNMA190616 SNMA644	1,6 0.063	19,05 0.750	6,35 0.250	7,92 0.312	90,0	0,0											■	■																	
	SNMG190616-M1 SNMP644-M1	1,6 0.063	19,05 0.750	6,35 0.250	7,92 0.312	90,0	0,0																													
Workpiece materials	SNMG190616-M3 SNMG644-M3	1,6 0.063	19,05 0.750	6,35 0.250	7,92 0.312	90,0	0,0				■																									
	SNMG190616-M5 SNMG644-M5	1,6 0.063	19,05 0.750	6,35 0.250	7,92 0.312	90,0	0,0	■	■	■	■	■	■	■	■																					
Workpiece materials	SNMG190616-M6 SNMG644-M6	1,6 0.063	19,05 0.750	6,35 0.250	7,92 0.312	90,0	0,0	■	■	■	■																									
	SNMG190616-MR3 SNMG644-MR3	1,6 0.063	19,05 0.750	6,35 0.250	7,92 0.312	90,0	0,0																													
Workpiece materials	SNMG190616-MR4 SNMG644-MR4	1,6 0.063	19,05 0.750	6,35 0.250	7,92 0.312	90,0	0,0																													
	SNMG190616-MR7 SNMG644-MR7	1,6 0.063	19,05 0.750	6,35 0.250	7,92 0.312	90,0	0,0	■	■	■	■	■	■	■	■																					

Designation	RE	L	S	D1	EPSR°	AN°	Cemented Carbide and Cermet Grades																			
							Coated													Uncoated				Cermet		
							TP0501	TP1501	TP2501	TP3501	TP25	TP40	TM1501	TM2501	TM3501	TK0501	TK1501	TS2000	TS2050	TS2500	TH1000	TH1500	CP200	CP500	CP600	HX
mm Inch	mm Inch	mm Inch	mm Inch																							
SNMM190616-R4 SNMM644-R4	1.6 0.063	19.05 0.750	6.35 0.250	7.92 0.312	90,0	0,0	■	■	■	■	■	■														
SNMM190616-R5 SNMM644-R5	1.6 0.063	19.05 0.750	6.35 0.250	7.92 0.312	90,0	0,0			■																	
SNMM190616-R56 SNMM644-R56	1.6 0.063	19.05 0.750	6.35 0.250	7.92 0.312	90,0	0,0				■																
SNMM190616-R57 SNMM644-R57	1.6 0.063	19.05 0.750	6.35 0.250	7.92 0.312	90,0	0,0		■	■																	
SNMM190616-R6 SNMM644-R6	1.6 0.063	19.05 0.750	6.35 0.250	7.92 0.312	90,0	0,0				■																
SNMM190616-R7 SNMM644-R7	1.6 0.063	19.05 0.750	6.35 0.250	7.92 0.312	90,0	0,0			■	■	■															
SNMM190616W-R7 SNMM644W-R7	1.6 0.063	19.05 0.750	6.35 0.250	7.92 0.312	90,0	0,0			■																	
SNMM190616-R8 SNMM643-R8	1.6 0.063	19.05 0.750	6.35 0.250	7.92 0.312	90,0	0,0				■		■														
SNMM190616-RR6 SNMM644-RR6	1.6 0.063	19.05 0.750	6.35 0.250	7.92 0.312	90,0	0,0			■	■			■													
SNMM190616-RR9 SNMM644-RR9	1.6 0.063	19.05 0.750	6.35 0.250	7.92 0.312	90,0	0,0						■														
SNMG190624-M6 SNMG646-M6	2.4 0.094	19.05 0.750	6.35 0.250	7.92 0.312	90,0	0,0	■	■	■	■																
SNMG190624-MR7 SNMG646-MR7	2.4 0.094	19.05 0.750	6.35 0.250	7.92 0.312	90,0	0,0			■		■															
SNMM190624-R4 SNMM646-R4	2.4 0.094	19.05 0.750	6.35 0.250	7.92 0.312	90,0	0,0	■		■	■	■															
SNMM190624-R5 SNMM646-R5	2.4 0.094	19.05 0.750	6.35 0.250	7.92 0.312	90,0	0,0			■																	
SNMM190624-R57 SNMM646-R57	2.4 0.094	19.05 0.750	6.35 0.250	7.92 0.312	90,0	0,0	■			■																
SNMM190624-R7 SNMM646-R7	2.4 0.094	19.05 0.750	6.35 0.250	7.92 0.312	90,0	0,0	■		■	■	■															
SNMM190624W-R7 SNMM646W-R7	2.4 0.094	19.05 0.750	6.35 0.250	7.92 0.312	90,0	0,0			■																	
SNMM190624-RR6 SNMM646-RR6	2.4 0.094	19.05 0.750	6.35 0.250	7.92 0.312	90,0	0,0			■				■													
SNMM250724-R56 SNMM856-R56	2.4 0.094	25.4 1.000	7.94 0.313	9.12 0.359	90,0	0,0			■	■																
SNMM250724-R57 SNMM856-R57	2.4 0.094	25.4 1.000	7.94 0.313	9.12 0.359	90,0	0,0			■	■	■															
SNMM250724-R7 SNMM856-R7	2.4 0.094	25.4 1.000	7.94 0.313	9.12 0.359	90,0	0,0	■		■	■	■															
SNMM250724-RR6 SNMM856-RR6	2.4 0.094	25.4 1.000	7.94 0.313	9.12 0.359	90,0	0,0			■				■													
SNMM250724-RR9 SNMM856-RR9	2.4 0.094	25.4 1.000	7.94 0.313	9.12 0.359	90,0	0,0				■		■														
SNMG250924-MR4 SNMG866-MR4	2.4 0.094	25.4 1.000	9.52 0.375	9.12 0.359	90,0	0,0																		■		
SNMG250924-MR7 SNMG866-MR7	2.4 0.094	25.4 1.000	9.52 0.375	9.12 0.359	90,0	0,0	■		■	■	■															
SNMM250924-R68 SNMM866-R68	2.4 0.094	25.4 1.000	9.52 0.375	9.12 0.359	90,0	0,0	■		■				■													
SNMM250924-R7 SNMM866-R7	2.4 0.094	25.4 1.000	9.52 0.375	9.12 0.359	90,0	0,0	■		■	■	■															

General ISO Turning
Inserts

Steadyline®

MDT

Mini-Shaft™

Grooving

Parting-off

X4

Adapters
Clamping units

Accessories and
Spare parts

Workpiece
materials

SNUN

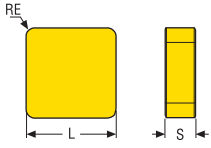

Tolerances:
L = $\pm 0,13/0.005$
S = $\pm 0,13/0.005$
RE = $\pm 0,1/0.004$

Please check availability at
www.secotools.com / Seco Online Store

SNUN

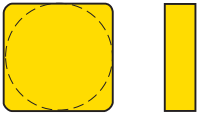

General ISO Turning
Inserts

Steadyline®

MDT

Mini-Shaft™

Grooving

Parting-off

X4

Adapters
Clamping units

Accessories and
Spare parts

Workpiece
materials

Designation	RE	L	S	EPSR°	AN°	Cemented Carbide and Cermet Grades																								
						Coated										Uncoated			Cermet											
	mm <i>Inch</i>	mm <i>Inch</i>	mm <i>Inch</i>			TP0501	TP1501	TP2501	TP3501	TP25	TP40	TM1501	TM2501	TM3501	TK0501	TK1501	TS2000	TS2050	TS2500	TH1000	TH1500	CP200	CP500	CP600	HX	KX	883	890	TP1030	TP1020
SNUN120412	1,2	12,7	4,762													■														
SNUN120412	0.047	0.500	0.187	90,0	0,0																									

* Right-hand version shown

Please check availability at www.secotools.com / Seco Online Store

TCGT

Tolerances:
 IC = ±0,025/0.001
 S = ±0,05/0.002
 RE (≥0,2/0.008) = ±0,1/0.004
 RE (≤0,1/0.004) = ±0,025/0.001

TCGX

Tolerances:
 IC = ±0,025/0.001
 S = ±0,13/0.005
 RE = ±0,1/0.004

TCMT, TCMX

Tolerances:
 IC = ±0,05/0.002
 S = ±0,05/0.002
 S = ±0,13/0.005
 RE = ±0,1/0.004

Size:
 11-16/2-3
 22/4
 11-16/2-3
 22/4

TCGT, TCGX, TCMT, TCMX

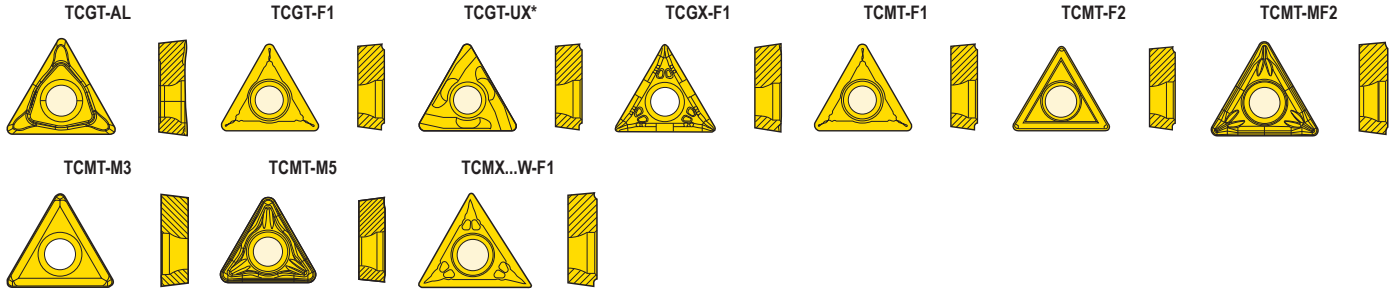
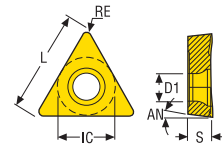

Designation	RE	IC	L	S	D1	EPRS°	AN°	Cemented Carbide and Cermet Grades																				
								Coated											Uncoated		Cermet							
								TP0501	TP1501	TP2501	TP3501	TP25	TP40	TM1501	TM2501	TM3501	TK0501	TK1501	TS2000	TS2050	TS2500	TH1000	TH1500	CP200	CP500	CP600	HX	KX
TCGT090202F-AL TCGT1.81.50.5F-AL	0,2 0.008	5,56 0.219	9,63 0.379	2,38 0.094	2,5 0.098	60,0	7,0																					
TCGT090204F-AL TCGT1.81.51F-AL	0,4 0.016	5,56 0.219	9,63 0.379	2,38 0.094	2,5 0.098	60,0	7,0																					
TCGT110201-F1 TCGT21.50-F1	0,1 0.004	6,35 0.250	11,0 0.433	2,38 0.094	2,9 0.114	60,0	7,0																					
TCGT110202F-AL TCGT21.50.5F-AL	0,2 0.008	6,35 0.250	11,0 0.433	2,38 0.094	2,8 0.110	60,0	7,0																					
TCGT110202R-UX TCGT21.50.5R-UX	0,2 0.008	6,35 0.250	11,0 0.433	2,38 0.094	2,8 0.110	60,0	7,0																					
TCGT110202L-UX TCGT21.50.5L-UX	0,2 0.008	6,35 0.250	11,0 0.433	2,38 0.094	2,8 0.110	60,0	7,0																					
TCMT110202-F1 TCMT21.50.5-F1	0,2 0.008	6,35 0.250	11,0 0.433	2,38 0.094	2,9 0.114	60,0	7,0																					
TCGT110204F-AL TCGT21.51F-AL	0,4 0.016	6,35 0.250	11,0 0.433	2,38 0.094	2,8 0.110	60,0	7,0																					
TCGT110204R-UX TCGT21.51R-UX	0,4 0.016	6,35 0.250	11,0 0.433	2,38 0.094	2,8 0.110	60,0	7,0																					
TCGT110204L-UX TCGT21.51L-UX	0,4 0.016	6,35 0.250	11,0 0.433	2,38 0.094	2,8 0.110	60,0	7,0																					
TCMT110204-F1 TCMT21.51-F1	0,4 0.016	6,35 0.250	11,0 0.433	2,38 0.094	2,9 0.114	60,0	7,0																					
TCMT110204-MF2 TCMT21.51-MF2	0,4 0.016	6,35 0.250	11,0 0.433	2,38 0.094	2,9 0.114	60,0	7,0																					
TCGT110208F-AL TCGT21.52F-AL	0,8 0.031	6,35 0.250	11,0 0.433	2,38 0.094	2,8 0.110	60,0	7,0																					
TCMT110208-F1 TCMT21.52-F1	0,8 0.031	6,35 0.250	11,0 0.433	2,38 0.094	2,9 0.114	60,0	7,0																					
TCMT110208-MF2 TCMT21.52-MF2	0,8 0.031	6,35 0.250	11,0 0.433	2,38 0.094	2,9 0.114	60,0	7,0																					
TCGX16T302WR-F1 TCGX32.50.5WR-F1	0,2 0.008	9,525 0.375	16,5 0.650	3,97 0.156	4,5 0.177	60,0	7,0																					
TCGX16T302WL-F1 TCGX32.50.5WL-F1	0,2 0.008	9,525 0.375	16,5 0.650	3,97 0.156	4,5 0.177	60,0	7,0																					
TCMT16T302-F1 TCMT32.50.5-F1	0,2 0.008	9,525 0.375	16,5 0.650	3,97 0.156	4,5 0.177	60,0	7,0																					
TCGT16T304F-AL TCGT32.51F-AL	0,4 0.016	9,525 0.375	16,5 0.650	3,97 0.156	4,4 0.173	60,0	7,0																					
TCMT16T304-F1 TCMT32.51-F1	0,4 0.016	9,525 0.375	16,5 0.650	3,97 0.156	4,5 0.177	60,0	7,0																					

General ISO Turning Inserts

Steadyline®

MDT

Mini-Shaft™

Grooving

Parting-off

X4

Adapters Clamping units

Accessories and Spare parts

Workpiece materials

General ISO Turning Inserts	Designation	RE mm Inch	IC mm Inch	L mm Inch	S mm Inch	D1 mm Inch	EPRS°	AN°	Cemented Carbide and Cermet Grades																								
									Coated																	Uncoated				Cermet			
									TP0601	TP1601	TP2601	TP3601	TP25	TP40	TM1601	TM2601	TM3601	TK0601	TK1601	TS2000	TS2050	TS2600	TH1000	TH1500	CP200	CP500	CP600	HX	KX	883	890	TP1030	TP1020
General ISO Turning Inserts	TCMT16T304-F2	0,4	9,525	16,5	3,97	4,5	60,0	7,0																									
	TCMT32.51-F2	0.016	0.375	0.650	0.156	0.177																											
General ISO Turning Inserts	TCMT16T304-M3	0,4	9,525	16,5	3,97	4,5	60,0	7,0																									
	TCMT32.51-M3	0.016	0.375	0.650	0.156	0.177																											
Steadyline®	TCMT16T304-MF2	0,4	9,525	16,5	3,97	4,5	60,0	7,0																									
	TCMT32.51-MF2	0.016	0.375	0.650	0.156	0.177																											
Steadyline®	TCGT16T308F-AL	0,8	9,525	16,5	3,97	4,4	60,0	7,0																									
	TCGT32.52F-AL	0.031	0.375	0.650	0.156	0.173																											
Steadyline®	TCMT16T308-F1	0,8	9,525	16,5	3,97	4,5	60,0	7,0																									
	TCMT32.52-F1	0.031	0.375	0.650	0.156	0.177																											
MDT	TCMT16T308-F2	0,8	9,525	16,5	3,97	4,5	60,0	7,0																									
	TCMT32.52-F2	0.031	0.375	0.650	0.156	0.177																											
MDT	TCMT16T308-M3	0,8	9,525	16,5	3,97	4,5	60,0	7,0																									
	TCMT32.52-M3	0.031	0.375	0.650	0.156	0.177																											
MDT	TCMT16T308-M5	0,8	9,525	16,5	3,97	4,5	60,0	7,0																									
	TCMT32.52-M5	0.031	0.375	0.650	0.156	0.177																											
Mini-Shaft™	TCMT16T308-MF2	0,8	9,525	16,5	3,97	4,5	60,0	7,0																									
	TCMT32.52-MF2	0.031	0.375	0.650	0.156	0.177																											
Mini-Shaft™	TCMX16T308W-F1	0,8	9,525	16,5	3,97	4,5	60,0	7,0																									
	TCMX32.52W-F1	0.031	0.375	0.650	0.156	0.177																											
Mini-Shaft™	TCMT16T312-F1	1,2	9,525	16,5	3,97	4,5	60,0	7,0																									
	TCMT32.53-F1	0.047	0.375	0.650	0.156	0.177																											
Mini-Shaft™	TCMT16T312-M5	1,2	9,525	16,5	3,97	4,5	60,0	7,0																									
	TCMT32.53-M5	0.047	0.375	0.650	0.156	0.177																											
Grooving	TCMT220404-F2	0,4	12,7	22,0	4,76	5,6	60,0	7,0																									
	TCMT431-F2	0.016	0.500	0.866	0.187	0.220																											
Grooving	TCMT220408-M3	0,8	12,7	22,0	4,76	5,6	60,0	7,0																									
	TCMT432-M3	0.031	0.500	0.866	0.187	0.220																											

Please check availability at
www.secotools.com / Seco Online Store

Tolerances:
IC = ±0,025/0,001
S = ±0,025/0,001
RE = ±0,025/0,001

TDAB, TDCH

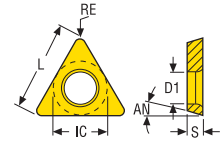

TDAB

TDCH*

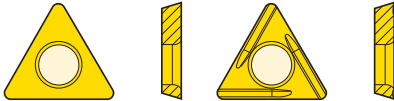

Designation	RE	IC	L	S	D1	EPSR°	AN°	Cemented Carbide and Cermet Grades																					
								Coated										Uncoated		Cermet									
								TP0501	TP1501	TP2501	TP3501	TP25	TP40	TM1501	TM2501	TM3501	TK0501	TK1501	TS2000	TS2050	TS2500	TH1000	TH1500	CP200	CP500	CP600	HX	KX	883
TDAB06T0005 TDAB1.21.50	0,05 0.002	4,064 0.160	6,8 0.268	1,194 0.047	2,36 0.093	60,0	15,0														■				■				
TDAB06T002 TDAB1.21.50.5	0,2 0.008	4,064 0.160	6,8 0.268	1,194 0.047	2,36 0.093	60,0	15,0														■				■				
TDCH06T002L TDCH1.21.50.5L	0,2 0.008	4,064 0.160	6,8 0.268	1,194 0.047	2,36 0.093	60,0	15,0														■								
TDCH06T002R TDCH1.21.50.5R	0,2 0.008	4,064 0.160	6,8 0.268	1,194 0.047	2,36 0.093	60,0	15,0														■								
TDAB06T004 TDAB1.21.51	0,4 0.016	4,064 0.160	6,8 0.268	1,194 0.047	2,36 0.093	60,0	15,0														■				■				
TDCH06T004L TDCH1.21.51L	0,4 0.016	4,064 0.160	6,8 0.268	1,194 0.047	2,36 0.093	60,0	15,0														■								
TDCH06T004R TDCH1.21.51R	0,4 0.016	4,064 0.160	6,8 0.268	1,194 0.047	2,36 0.093	60,0	15,0														■								

General ISO Turning
Inserts

Steadyline®

MDT

Mini-Shaft™

Grooving

Parting-off

X4

Adapters
Clamping units

Accessories and
Spare parts

Workpiece
materials

TNMA, TNMG, TNMM, TNMX

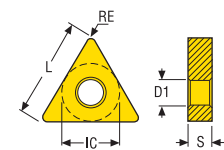

Tolerances: IC = ±0.05/0.002
IC = ±0.08/0.003
IC = ±0.10/0.004
S = ±0.13/0.005
RE = ±0.1/0.004

Size: 11-16/2-3
22/4
27-33/5-6

* Right-hand version shown

Please check availability at
www.secotools.com / Seco Online Store

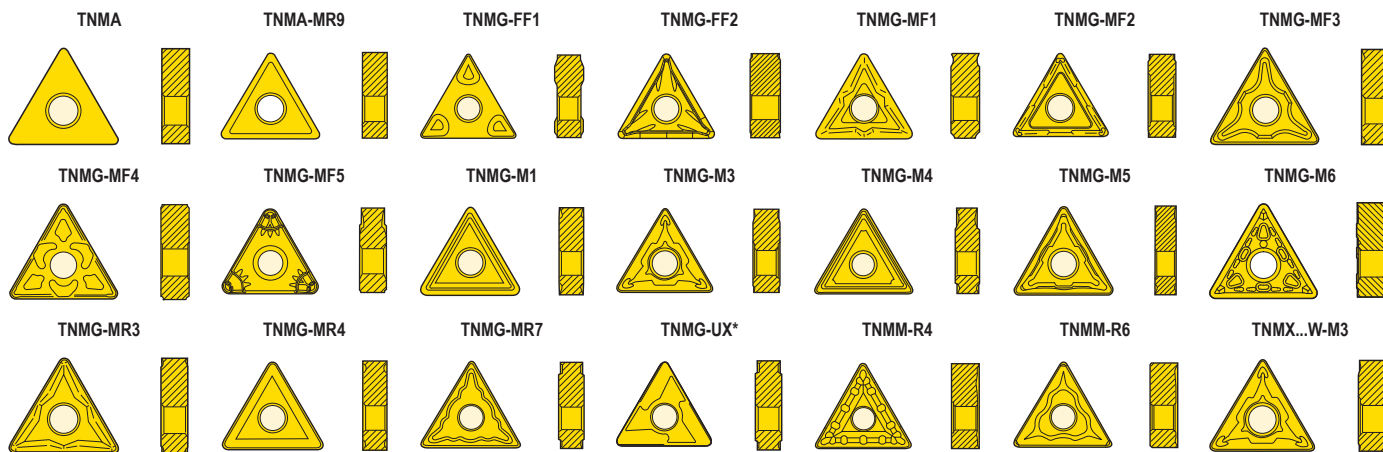

Designation	RE mm Inch	IC mm Inch	L mm Inch	S mm Inch	D1 mm Inch	EPRS°	AN°	Cemented Carbide and Cermet Grades																										
								Coated												Uncoated				Cermet										
								TP0501	TP1501	TP2501	TP3501	TP25	TP40	TM1501	TM2501	TM3501	TK0501	TK1501	TS2000	TS2050	TS2500	TH1000	TH1500	CP200	CP500	CP600	HX	KX	883	890	TP1030	TP1020		
TNMG110304-MF2 TNMG221-MF2	0,4 0.016	6,35 0.250	11,0 0.433	3,18 0.125	2,26 0.089	60,0	0,0			■																								
TNMG110304-MR4 TNMG221-MR4	0,4 0.016	6,35 0.250	11,0 0.433	3,18 0.125	2,26 0.089	60,0	0,0																										■	
TNMG110308-MR4 TNMG222-MR4	0,8 0.031	6,35 0.250	11,0 0.433	3,18 0.125	2,26 0.089	60,0	0,0																										■	
TNMG160304-MR4 TNMG321-MR4	0,4 0.016	9,525 0.375	16,5 0.650	3,18 0.125	3,81 0.150	60,0	0,0																										■	
TNMG160308-M5 TNMG322-M5	0,8 0.031	9,525 0.375	16,5 0.650	3,18 0.125	3,81 0.150	60,0	0,0				■		■																					
TNMG160308-MF3 TNMG322-MF3	0,8 0.031	9,525 0.375	16,5 0.650	3,18 0.125	3,81 0.150	60,0	0,0				■																							
TNMG160308-MR4 TNMG322-MR4	0,8 0.031	9,525 0.375	16,5 0.650	3,18 0.125	3,81 0.150	60,0	0,0																										■	
TNMA160404 TNMA331	0,4 0.016	9,525 0.375	16,5 0.650	4,76 0.187	3,81 0.150	60,0	0,0											■																
TNMG160404-FF1 TNMG331-FF1	0,4 0.016	9,525 0.375	16,5 0.650	4,76 0.187	3,81 0.150	60,0	0,0											■																■
TNMG160404-FF2 TNMG331-FF2	0,4 0.016	9,525 0.375	16,5 0.650	4,76 0.187	3,81 0.150	60,0	0,0		■	■																■								■
TNMG160404-M3 TNMG331-M3	0,4 0.016	9,525 0.375	16,5 0.650	4,76 0.187	3,81 0.150	60,0	0,0		■	■	■	■	■		■	■		■																
TNMG160404-M5 TNMG331-M5	0,4 0.016	9,525 0.375	16,5 0.650	4,76 0.187	3,81 0.150	60,0	0,0				■	■																						
TNMG160404-MF1 TNMP331-MF1	0,4 0.016	9,525 0.375	16,5 0.650	4,762 0.187	3,81 0.150	60,0	0,0							■	■	■									■									
TNMG160404-MF2 TNMG331-MF2	0,4 0.016	9,525 0.375	16,5 0.650	4,76 0.187	3,81 0.150	60,0	0,0		■	■	■	■																					■	■
TNMG160404-MF3 TNMG331-MF3	0,4 0.016	9,525 0.375	16,5 0.650	4,76 0.187	3,81 0.150	60,0	0,0					■																						
TNMG160404-MF4 TNMG331-MF4	0,4 0.016	9,525 0.375	16,5 0.650	4,76 0.187	3,81 0.150	60,0	0,0							■	■	■																		
TNMG160404-MF5 TNMG331-MF5	0,4 0.016	9,525 0.375	16,5 0.650	4,76 0.187	3,81 0.150	60,0	0,0															■	■											

Designation	RE	IC	L	S	D1	EPR ^o	AN ^o	Cemented Carbide and Cermet Grades																		
								Coated										Uncoated				Cermet				
								TP0501	TP1501	TP2501	TP3501	TP25	TP40	TM1501	TM2501	TM3501	TK0501	TK1501	TS2000	TS2050	TS2500	TH1000	TH1500	CP200	CP500	CP600
mm Inch	mm Inch	mm Inch	mm Inch	mm Inch																						
TNMG160404R-UX TNMG331R-UX	0,4 0.016	9,525 0.375	16,5 0.650	4,76 0.187	3,81 0.150	60,0	0,0																			
TNMG160404L-UX TNMG331L-UX	0,4 0.016	9,525 0.375	16,5 0.650	4,76 0.187	3,81 0.150	60,0	0,0																			
TNMM160404-R6 TNMM331-R6	0,4 0.016	9,525 0.375	16,5 0.650	4,76 0.187	3,81 0.150	60,0	0,0																			
TNMA160408 TNMA332	0,8 0.031	9,525 0.375	16,5 0.650	4,76 0.187	3,81 0.150	60,0	0,0																			
TNMG160408-FF1 TNMG332-FF1	0,8 0.031	9,525 0.375	16,5 0.650	4,76 0.187	3,81 0.150	60,0	0,0																			
TNMG160408-FF2 TNMG332-FF2	0,8 0.031	9,525 0.375	16,5 0.650	4,76 0.187	3,81 0.150	60,0	0,0																			
TNMG160408-M1 TNMP332-M1	0,8 0.031	9,525 0.375	16,5 0.650	4,76 0.187	3,81 0.150	60,0	0,0																			
TNMG160408-M3 TNMG332-M3	0,8 0.031	9,525 0.375	16,5 0.650	4,76 0.187	3,81 0.150	60,0	0,0																			
TNMG160408-M4 TNMG332-M4	0,8 0.031	9,525 0.375	16,5 0.650	4,76 0.187	3,81 0.150	60,0	0,0																			
TNMG160408-M5 TNMG332-M5	0,8 0.031	9,525 0.375	16,5 0.650	4,76 0.187	3,81 0.150	60,0	0,0																			
TNMG160408-M6 TNMG332-M6	0,8 0.031	9,525 0.375	16,5 0.650	4,76 0.187	3,81 0.150	60,0	0,0																			
TNMG160408-MF1 TNMP332-MF1	0,8 0.031	9,525 0.375	16,5 0.650	4,76 0.187	3,81 0.150	60,0	0,0																			
TNMG160408-MF2 TNMG332-MF2	0,8 0.031	9,525 0.375	16,5 0.650	4,76 0.187	3,81 0.150	60,0	0,0																			
TNMG160408-MF3 TNMG332-MF3	0,8 0.031	9,525 0.375	16,5 0.650	4,76 0.187	3,81 0.150	60,0	0,0																			
TNMG160408-MF4 TNMG332-MF4	0,8 0.031	9,525 0.375	16,5 0.650	4,76 0.187	3,81 0.150	60,0	0,0																			
TNMG160408-MF5 TNMG332-MF5	0,8 0.031	9,525 0.375	16,498 0.650	4,76 0.187	3,81 0.150	60,0	0,0																			
TNMG160408-MR4 TNMG332-MR4	0,8 0.031	9,525 0.375	16,5 0.650	4,76 0.187	3,81 0.150	60,0	0,0																			
TNMG160408-MR7 TNMG332-MR7	0,8 0.031	9,525 0.375	16,5 0.650	4,76 0.187	3,81 0.150	60,0	0,0																			
TNMG160408R-UX TNMG332R-UX	0,8 0.031	9,525 0.375	16,5 0.650	4,76 0.187	3,81 0.150	60,0	0,0																			
TNMG160408L-UX TNMG332L-UX	0,8 0.031	9,525 0.375	16,5 0.650	4,76 0.187	3,81 0.150	60,0	0,0																			
TNMM160408-R4 TNMM332-R4	0,8 0.031	9,525 0.375	16,5 0.650	4,76 0.187	3,81 0.150	60,0	0,0																			
TNMM160408-R6 TNMM332-R6	0,8 0.031	9,525 0.375	16,5 0.650	4,76 0.187	3,81 0.150	60,0	0,0																			
TNMX160408W-M3 TNMX332W-M3	0,8 0.031	9,525 0.375	16,5 0.650	4,76 0.187	3,81 0.150	60,0	0,0																			
TNMA160412-MR9 TNMA333-MR9	1,2 0.047	9,525 0.375	16,5 0.650	4,76 0.187	3,81 0.150	60,0	0,0																			
TNMA160412 TNMA333	1,2 0.047	9,525 0.375	16,5 0.650	4,76 0.187	3,81 0.150	60,0	0,0																			
TNMG160412-M3 TNMG333-M3	1,2 0.047	9,525 0.375	16,5 0.650	4,76 0.187	3,81 0.150	60,0	0,0																			
TNMG160412-M5 TNMG333-M5	1,2 0.047	9,525 0.375	16,5 0.650	4,76 0.187	3,81 0.150	60,0	0,0																			
TNMG160412-M6 TNMG333-M6	1,2 0.047	9,525 0.375	16,5 0.650	4,76 0.187	3,81 0.150	60,0	0,0																			
TNMG160412-MF1 TNMP333-MF1	1,2 0.047	9,525 0.375	16,5 0.650	4,76 0.187	3,81 0.150	60,0	0,0																			
TNMG160412-MF2 TNMG333-MF2	1,2 0.047	9,525 0.375	16,5 0.650	4,76 0.187	3,81 0.150	60,0	0,0																			

General ISO Turning Inserts
Steadyline[®]
MDT
Mini-Shaft[™]
Grooving
Parting-off
X4
Adapters Clamping units
Accessories and Spare parts
Workpiece materials

Designation	RE	IC	L	S	D1	EPR ^o	AN ^o	Cemented Carbide and Cermet Grades																		
								Coated												Uncoated			Cermet			
								TP0501	TP1501	TP2501	TP3501	TP25	TP40	TM1501	TM2501	TM3501	TK0501	TK1501	TS2000	TS2050	TS2500	TH1000	TH1500	CP200	CP500	CP600
mm Inch	mm Inch	mm Inch	mm Inch	mm Inch																						
TNMG220412-MF4 TNMG433-MF4	1,2 0.047	12,7 0.500	22,0 0.866	4,76 0.187	5,15 0.203	60,0	0,0																			
TNMG220412-MR3 TNMG433-MR3	1,2 0.047	12,7 0.500	22,0 0.866	4,76 0.187	5,15 0.203	60,0	0,0																			
TNMG220412-MR4 TNMG433-MR4	1,2 0.047	12,7 0.500	22,0 0.866	4,76 0.187	5,15 0.203	60,0	0,0																			
TNMG220412-MR7 TNMG433-MR7	1,2 0.047	12,7 0.500	22,0 0.866	4,76 0.187	5,15 0.203	60,0	0,0																			
TNMM220412-R4 TNMM433-R4	1,2 0.047	12,7 0.500	22,0 0.866	4,76 0.187	5,15 0.203	60,0	0,0																			
TNMA220416-MR9 TNMA434-MR9	1,6 0.063	12,7 0.500	22,0 0.866	4,76 0.187	5,15 0.203	60,0	0,0																			
TNMA220416 TNMA434	1,6 0.063	12,7 0.500	22,0 0.866	4,76 0.187	5,15 0.203	60,0	0,0																			
TNMG220416-M1 TNMP434-M1	1,6 0.063	12,7 0.500	22,0 0.866	4,76 0.187	5,15 0.203	60,0	0,0																			
TNMG220416-M5 TNMG434-M5	1,6 0.063	12,7 0.500	22,0 0.866	4,76 0.187	5,15 0.203	60,0	0,0																			
TNMG220416-M6 TNMG434-M6	1,6 0.063	12,7 0.500	22,0 0.866	4,76 0.187	5,15 0.203	60,0	0,0																			
TNMG220416-MR4 TNMG434-MR4	1,6 0.063	12,7 0.500	22,0 0.866	4,76 0.187	5,15 0.203	60,0	0,0																			
TNMM220416-R4 TNMM434-R4	1,6 0.063	12,7 0.500	22,0 0.866	4,76 0.187	5,15 0.203	60,0	0,0																			
TNMM220416-R6 TNMM434-R6	1,6 0.063	12,7 0.500	22,0 0.866	4,76 0.187	5,15 0.203	60,0	0,0																			
TNMG220424-MR4 TNMG436-MR4	2,4 0.094	12,7 0.500	22,0 0.866	4,76 0.187	5,15 0.203	60,0	0,0																			
TNMG220432-MR4 TNMG438-MR4	3,2 0.126	12,7 0.500	22,0 0.866	4,76 0.187	5,15 0.203	60,0	0,0																			
TNMG270608-M5 TNMG542-M5	0,8 0.031	15,875 0.625	27,5 1.083	6,35 0.250	6,35 0.250	60,0	0,0																			
TNMG270608-MR4 TNMG542-MR4	0,8 0.031	15,875 0.625	27,5 1.083	6,35 0.250	6,35 0.250	60,0	0,0																			
TNMG270612-M3 TNMG543-M3	1,2 0.047	15,875 0.625	27,5 1.083	6,35 0.250	6,35 0.250	60,0	0,0																			
TNMG270612-M5 TNMG543-M5	1,2 0.047	15,875 0.625	27,5 1.083	6,35 0.250	6,35 0.250	60,0	0,0																			
TNMG270612-M6 TNMG543-M6	1,2 0.047	15,875 0.625	27,5 1.083	6,35 0.250	6,35 0.250	60,0	0,0																			
TNMG270612-MR4 TNMG543-MR4	1,2 0.047	15,875 0.625	27,5 1.083	6,35 0.250	6,35 0.250	60,0	0,0																			
TNMG270612-MR7 TNMG543-MR7	1,2 0.047	15,875 0.625	27,5 1.083	6,35 0.250	6,35 0.250	60,0	0,0																			
TNMG270616-M5 TNMG544-M5	1,6 0.063	15,875 0.625	27,5 1.083	6,35 0.250	6,35 0.250	60,0	0,0																			
TNMG270616-M6 TNMG544-M6	1,6 0.063	15,875 0.625	27,5 1.083	6,35 0.250	6,35 0.250	60,0	0,0																			
TNMG270616-MR4 TNMG544-MR4	1,6 0.063	15,875 0.625	27,5 1.083	6,35 0.250	6,35 0.250	60,0	0,0																			
TNMG270616-MR7 TNMG544-MR7	1,6 0.063	15,875 0.625	27,5 1.083	6,35 0.250	6,35 0.250	60,0	0,0																			
TNMG270632-MR4 TNMG548-MR4	3,2 0.126	15,875 0.625	27,5 1.083	6,35 0.250	6,35 0.250	60,0	0,0																			
TNMG330924-MR4 TNMG666-MR4	2,4 0.094	19,05 0.750	33,0 1.299	9,52 0.375	7,92 0.312	60,0	0,0																			
TNMG330924-MR7 TNMG666-MR7	2,4 0.094	19,05 0.750	33,0 1.299	9,52 0.375	7,92 0.312	60,0	0,0																			

General ISO Turning Inserts
Steadyline®
MDT
Mini-Shaft™
Grooving
Parting-off
X4
Adapters Clamping units
Accessories and Spare parts
Workpiece materials

General ISO Turning Inserts	Designation	RE	IC	L	S	D1	EPSR°	AN°	Cemented Carbide and Cermet Grades																			
									Coated															Uncoated				Cermet
									TP0501	TP1501	TP2501	TP3501	TP25	TP40	TM1501	TM2501	TM3501	TK0501	TK1501	TS2000	TS2050	TS2500	TH1000	TH1500	CP200	CP500	CP600	HX
mm Inch	mm Inch	mm Inch	mm Inch	mm Inch	mm Inch																							
Steadyline®	VBMT160404-MF2 VBMT331-MF2	0,4 0.016	9,525 0.375	16,61 0.654	4,76 0.187	4,5 0.177	35,0	5,0	■	■	■	■													■	■		
	VBGT160408-F1 VBGT332-F1	0,8 0.031	9,525 0.375	16,6 0.654	4,762 0.187	4,5 0.177	35,0	5,0					■															
MDT	VBMT160408-M3 VBMT332-M3	0,8 0.031	9,525 0.375	16,6 0.654	4,76 0.187	4,5 0.177	35,0	5,0													■							
	VBMT160408-F1 VBMT332-F1	0,8 0.031	9,525 0.375	16,61 0.654	4,76 0.187	4,5 0.177	35,0	5,0	■	■	■	■			■	■	■	■							■	■		
Mini-Shaft™	VBMT160408-F2 VBMT332-F2	0,8 0.031	9,525 0.375	16,61 0.654	4,76 0.187	4,5 0.177	35,0	5,0					■				■			■								
	VBMT160408-M3 VBMT332-M3	0,8 0.031	9,525 0.375	16,61 0.654	4,76 0.187	4,5 0.177	35,0	5,0	■	■	■	■			■													
Grooving	VBMT160408-M5 VBMT332-M5	0,8 0.031	9,525 0.375	16,61 0.654	4,76 0.187	4,5 0.177	35,0	5,0	■	■	■	■			■													
	VBMT160408-MF2 VBMT332-MF2	0,8 0.031	9,525 0.375	16,61 0.654	4,76 0.187	4,5 0.177	35,0	5,0	■	■	■	■					■							■	■			
Parting-off	VBMT160412-F1 VBMT333-F1	1,2 0.047	9,525 0.375	16,61 0.654	4,76 0.187	4,5 0.177	35,0	5,0		■	■	■	■															
	VBMT160412-F2 VBMT333-F2	1,2 0.047	9,525 0.375	16,61 0.654	4,76 0.187	4,5 0.177	35,0	5,0																				
X4	VBMT160412-M3 VBMT333-M3	1,2 0.047	9,525 0.375	16,61 0.654	4,76 0.187	4,5 0.177	35,0	5,0		■	■	■	■															
	VBMT160412-MF2 VBMT333-MF2	1,2 0.047	9,525 0.375	16,61 0.654	4,76 0.187	4,5 0.177	35,0	5,0	■	■	■																	

VCGT

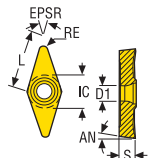

Tolerances:
IC = ±0,025/0.001
S = ±0,05/0.002
RE = ±0,1/0.004

Please check availability at
www.secotools.com / Seco Online Store

VCGT-AL

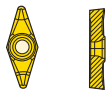

Adapters Clamping units	Designation	RE	IC	L	S	D1	EPSR°	AN°	Cemented Carbide and Cermet Grades																			
									Coated															Uncoated				Cermet
									TP0501	TP1501	TP2501	TP3501	TP25	TP40	TM1501	TM2501	TM3501	TK0501	TK1501	TS2000	TS2050	TS2500	TH1000	TH1500	CP200	CP500	CP600	HX
mm Inch	mm Inch	mm Inch	mm Inch	mm Inch	mm Inch	mm Inch																						
Accessories and Spare parts	VCGT110302F-AL VCGT220.5F-AL	0,2 0.008	6,35 0.250	11,1 0.437	3,18 0.125	2,8 0.110	35,0	7,0																				
	VCGT110304F-AL VCGT221F-AL	0,4 0.016	6,35 0.250	11,1 0.437	3,18 0.125	2,8 0.110	35,0	7,0																				
Workpiece materials	VCGT160402F-AL VCGT330.5F-AL	0,2 0.008	9,525 0.375	16,6 0.654	4,76 0.187	4,4 0.173	35,0	7,0																				
	VCGT160404F-AL VCGT331F-AL	0,4 0.016	9,525 0.375	16,6 0.654	4,76 0.187	4,4 0.173	35,0	7,0																				
Workpiece materials	VCGT160408F-AL VCGT332F-AL	0,8 0.031	9,525 0.375	16,6 0.654	4,76 0.187	4,4 0.173	35,0	7,0																				
	VCGT160412F-AL VCGT333F-AL	1,2 0.047	9,525 0.375	16,6 0.654	4,76 0.187	4,4 0.173	35,0	7,0																				

General ISO Turning Inserts	Cemented Carbide and Cermet Grades																													
	Designation	RE	IC	L	S	D1	EPSR°	AN°	Coated																Uncoated				Cermet	
									TP0601	TP1601	TP2601	TP3601	TP25	TP40	TM1601	TM2601	TM3601	TK0601	TK1601	TS2000	TS2050	TS2600	TH1000	TH1600	CP200	CP500	CP600	HX	KX	883
mm	mm	mm	mm	mm	mm																									
Inch	Inch	Inch	Inch	Inch	Inch																									
VNMA160408 VNMA332	0,8	9,525	16,6	4,76	3,81	35,0	0,0																							
	0.031	0.375	0.654	0.187	0.150																									
VNMG160408-FF2 VNMG332-FF2	0,8	9,525	16,6	4,76	3,81	35,0	0,0		■	■	■																		■	
	0.031	0.375	0.654	0.187	0.150																									
VNMG160408-M1 VNMP332-M1	0,8	9,525	16,6	4,76	3,81	35,0	0,0																						■	
	0.031	0.375	0.654	0.187	0.150																									
VNMG160408-M3 VNMG332-M3	0,8	9,525	16,6	4,76	3,81	35,0	0,0	■	■	■	■	■																		
	0.031	0.375	0.654	0.187	0.150																									
VNMG160408-MF2 VNMG332-MF2	0,8	9,525	16,6	4,76	3,81	35,0	0,0	■	■	■	■																			
	0.031	0.375	0.654	0.187	0.150																									
VNMG160408-MF3 VNMG332-MF3	0,8	9,525	16,6	4,76	3,81	35,0	0,0					■																		
	0.031	0.375	0.654	0.187	0.150																									
VNMG160408-MF4 VNMG332-MF4	0,8	9,525	16,61	4,76	3,81	35,0	0,0						■	■	■															
	0.031	0.375	0.654	0.187	0.150																									
VNMG160408-MF5 VNMG332-MF5	0,8	9,525	16,6	4,76	3,81	35,0	0,0																							■
	0.031	0.375	0.654	0.187	0.150																									
VNMG160408-MR4 VNMG332-MR4	0,8	9,525	16,6	4,76	3,81	35,0	0,0																							■
	0.031	0.375	0.654	0.187	0.150																									
VNMG160412-M3 VNMG333-M3	1,2	9,525	16,6	4,76	3,81	35,0	0,0	■	■	■	■	■																		
	0.047	0.375	0.654	0.187	0.150																									
VNMG160412-MF2 VNMG333-MF2	1,2	9,525	16,6	4,76	3,81	35,0	0,0		■	■																				
	0.047	0.375	0.654	0.187	0.150																									
VNMG160412-MR4 VNMG333-MR4	1,2	9,525	16,6	4,76	3,81	35,0	0,0																							■
	0.047	0.375	0.654	0.187	0.150																									
VNMG220404-MR4 VNMG431-MR4	0,4	12,7	22,0	4,76	5,15	35,0	0,0																							■
	0.016	0.500	0.866	0.187	0.203																									
VNGG220408-M1 VNGP432F-M1-203	0,8	12,7	22,0	4,76	5,15	35,0	0,0																							■
	0.031	0.500	0.866	0.187	0.203																									
VNMG220408-MF3-203 VNMG432-MF3-203	0,8	12,7	22,14	4,89	5,16	35,0	0,0																							■
	0.031	0.500	0.872	0.193	0.203																									
VNMG220408-MR4-203 VNMG432-MR4-203	0,8	12,7	22,0	4,76	5,15	35,0	0,0																							■
	0.031	0.500	0.866	0.187	0.203																									
VNMG220408-MR4 VNMG432-MR4	0,8	12,7	22,0	4,76	5,15	35,0	0,0																							■
	0.031	0.500	0.866	0.187	0.203																									
VNMG220412-MR4-203 VNMG433-MR4-203	1,2	12,7	22,0	4,76	5,15	35,0	0,0																							■
	0.047	0.500	0.866	0.187	0.203																									
VNMG220412-MR4 VNMG433-MR4	1,2	12,7	22,0	4,76	5,15	35,0	0,0																							■
	0.047	0.500	0.866	0.187	0.203																									
X4 VNMG220416-MR4 VNMG434-MR4	1,6	12,7	22,0	4,76	5,15	35,0	0,0																							■
	0.063	0.500	0.866	0.187	0.203																									

Please check availability at
www.secotools.com / Seco Online Store

Tolerances:
IC = ±0,05/0.002
S = ±0,05/0.002
RE = ±0,1/0.004

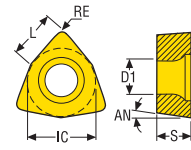

WCMT

General ISO Turning
Inserts

WCMT-F1



WCMT...W-F1



Designation	RE	IC	L	S	D1	EPSR°	AN°	Cemented Carbide and Cermet Grades																										
								Coated										Uncoated		Cermet														
	mm <i>Inch</i>	mm <i>Inch</i>	mm <i>Inch</i>	mm <i>Inch</i>	mm <i>Inch</i>			TP0501	TP1501	TP2501	TP3501	TP25	TP40	TM1501	TM2501	TM3501	TK0501	TK1501	TS2000	TS2050	TS2500	TH1000	TH1500	CP200	CP500	CP600	HX	KX	883	890	TP1030	TP1020		
WCMT06T308-F1	0,8	9,525	6,531	3,969	4,5																													
WCMT32.52-F1	0.031	0.375	0.257	0.156	0.177	80,0	7,0			■	■						■								■									
WCMT06T308W-F1	0,8	9,525	6,615	3,969	4,5	80,0	7,0				■														■									
WCMT32.52W-F1	0.031	0.375	0.260	0.156	0.177																													

Steadyline®

MDT

Mini-Shaft™

Grooving

Parting-off

X4

Adapters
Clamping units

Accessories and
Spare parts

Workpiece
materials

WNGG, WNMA, WNMG, WNMM

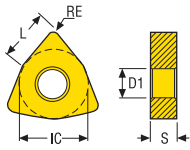

WNGG
Tolerances:
IC = ±0,025/0.001
S = ±0,13/0.005
RE = ±0,1/0.004

WNMA, WNMG, WNMM
Tolerances: Size:
IC = ±0,05/0.002 06/3
IC = ±0,08/0.003 08/4
S = ±0,13/0.005
RE = ±0,1/0.004

Please check availability at
www.secotools.com / Seco Online Store

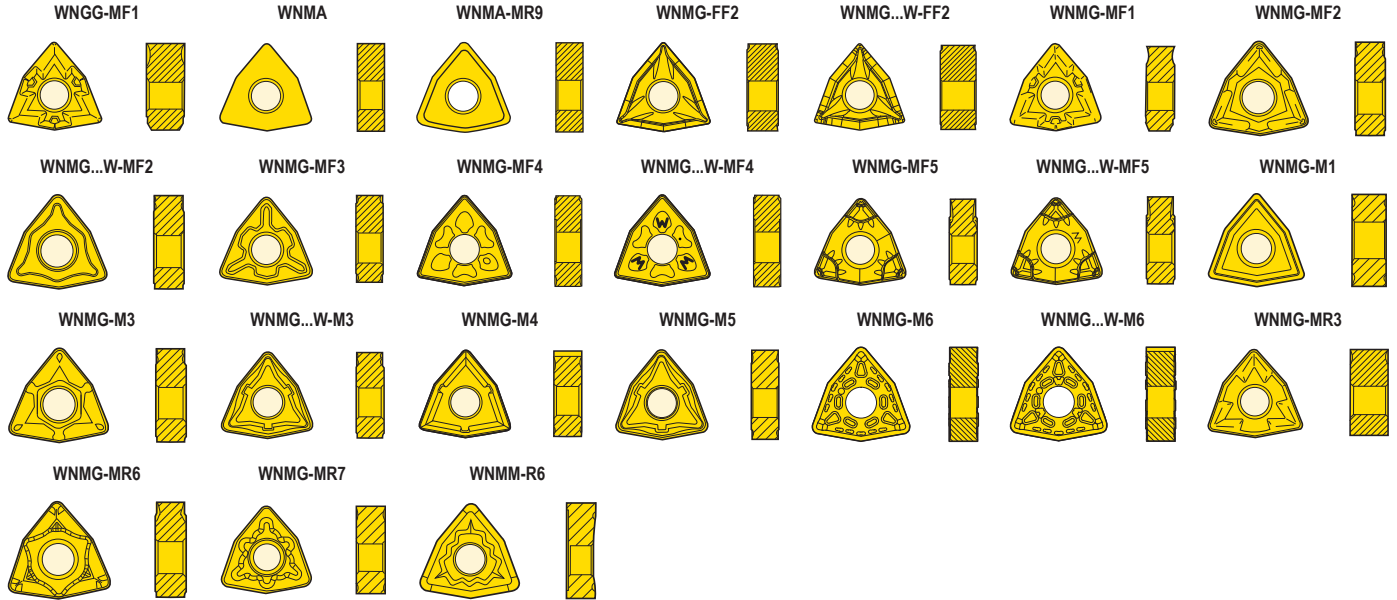

Designation	RE	IC	L	S	D1	EPSR°	AN°	Cemented Carbide and Cermet Grades																		
								Coated												Uncoated			Cermet			
								TP0501	TP1501	TP2501	TP3501	TP25	TP40	TM1501	TM2501	TM3501	TK0501	TK1501	TS2000	TS2050	TS2500	TH1000	TH1500	CP200	CP500	CP600
mm	mm	mm	mm	mm																						
WNGG060402-MF1	0,2	9,525	6,6	4,76	3,81	80,0	0,0										■								■	
WNGP330.5-MF1	0,008	0,375	0,260	0,187	0,150														■	■						
WNMG060402-M3	0,2	9,525	6,5	4,76	3,81	80,0	0,0	■																		
WNMG330.5-M3	0,008	0,375	0,256	0,187	0,150			■																		
WNMG060404-FF2	0,4	9,525	6,5	4,76	3,81	80,0	0,0	■	■										■						■	
WNGG331-FF2	0,016	0,375	0,256	0,187	0,150																					
WNMG060404W-FF2	0,4	9,525	6,5	4,76	3,81	80,0	0,0		■																■	
WNGG331W-FF2	0,016	0,375	0,256	0,187	0,150																					
WNMG060404-M3	0,4	9,525	6,5	4,76	3,81	80,0	0,0	■	■	■	■															
WNGG331-M3	0,016	0,375	0,256	0,187	0,150			■	■																	
WNMG060404-MF1	0,4	9,525	6,5	4,76	3,81	80,0	0,0						■	■				■							■	
WNMP331-MF1	0,016	0,375	0,256	0,187	0,150															■	■					
WNMG060404-MF2	0,4	9,525	6,5	4,76	3,81	80,0	0,0	■	■	■	■														■	■
WNGG331-MF2	0,016	0,375	0,256	0,187	0,150			■	■																	
WNMG060404W-MF2	0,4	9,525	6,5	4,76	3,81	80,0	0,0		■	■															■	
WNGG331W-MF2	0,016	0,375	0,256	0,187	0,150																					
WNMG060404-MF4	0,4	9,525	6,52	4,76	3,81	80,0	0,0						■	■	■											
WNGG331-MF4	0,016	0,375	0,257	0,187	0,150																					
WNMG060404-MF5	0,4	9,525	6,5	4,76	3,81	80,0	0,0				■															
WNGG331-MF5	0,016	0,375	0,256	0,187	0,150						■															
WNMA060408	0,8	9,525	6,5	4,76	3,81	80,0	0,0										■	■								
WNMA332	0,031	0,375	0,256	0,187	0,150																					
WNMG060408-FF2	0,8	9,525	6,5	4,76	3,81	80,0	0,0	■	■																■	
WNGG332-FF2	0,031	0,375	0,256	0,187	0,150			■	■																	
WNMG060408W-FF2	0,8	9,525	6,5	4,76	3,81	80,0	0,0				■														■	
WNGG332W-FF2	0,031	0,375	0,256	0,187	0,150						■															
WNMG060408-M3	0,8	9,525	6,5	4,76	3,81	80,0	0,0	■	■	■	■	■	■													
WNGG332-M3	0,031	0,375	0,256	0,187	0,150			■	■	■	■															
WNMG060408W-M3	0,8	9,525	6,5	4,76	3,81	80,0	0,0		■	■	■							■								
WNGG332W-M3	0,031	0,375	0,256	0,187	0,150				■	■	■															

Designation	RE	IC	L	S	D1	EPR ^o	AN ^o	Cemented Carbide and Cermet Grades																		
								Coated										Uncoated			Cermet					
								TP0501	TP1501	TP2501	TP3501	TP25	TP40	TM1501	TM2501	TM3501	TK0501	TK1501	TS2000	TS2050	TS2500	TH1000	TH1500	CP200	CP500	CP600
mm Inch	mm Inch	mm Inch	mm Inch	mm Inch																						
WNMG060408-M5 WNMG332-M5	0,8 0.031	9,525 0.375	6,5 0.256	4,76 0.187	3,81 0.150	80,0	0,0	■	■	■	■															
WNMG060408-MF1 WNMP332-MF1	0,8 0.031	9,525 0.375	6,5 0.256	4,76 0.187	3,81 0.150	80,0	0,0					■	■					■	■						■	
WNMG060408-MF2 WNMG332-MF2	0,8 0.031	9,525 0.375	6,5 0.256	4,76 0.187	3,81 0.150	80,0	0,0		■	■	■	■														■
WNMG060408W-MF2 WNMG332W-MF2	0,8 0.031	9,525 0.375	6,5 0.256	4,76 0.187	3,81 0.150	80,0	0,0		■	■																■
WNMG060408-MF3 WNMG332-MF3	0,8 0.031	9,525 0.375	6,5 0.256	4,76 0.187	3,81 0.150	80,0	0,0																			
WNMG060408-MF4 WNMG332-MF4	0,8 0.031	9,525 0.375	6,5 0.256	4,76 0.187	3,81 0.150	80,0	0,0				■	■	■						■							
WNMG060408W-MF4 WNMG332W-MF4	0,8 0.031	9,525 0.375	6,52 0.257	4,76 0.187	3,81 0.150	80,0	0,0				■	■	■													
WNMG060408-MF5 WNMG332-MF5	0,8 0.031	9,525 0.375	6,5 0.256	4,76 0.187	3,81 0.150	80,0	0,0				■															
WNMG060408W-MF5 WNMG332W-MF5	0,8 0.031	9,525 0.375	6,5 0.256	4,76 0.187	3,81 0.150	80,0	0,0		■	■																
WNMG060408-MR3 WNMG332-MR3	0,8 0.031	9,525 0.375	6,5 0.256	4,76 0.187	3,81 0.150	80,0	0,0												■	■					■	
WNMA060412 WNMA333	1,2 0.047	9,525 0.375	6,5 0.256	4,76 0.187	3,81 0.150	80,0	0,0																			
WNMG060412-M3 WNMG333-M3	1,2 0.047	9,525 0.375	6,5 0.256	4,76 0.187	3,81 0.150	80,0	0,0	■	■	■	■		■													
WNMG060412W-M3 WNMG333W-M3	1,2 0.047	9,525 0.375	6,5 0.256	4,76 0.187	3,81 0.150	80,0	0,0		■	■																
WNMG060412-M5 WNMG333-M5	1,2 0.047	9,525 0.375	6,5 0.256	4,76 0.187	3,81 0.150	80,0	0,0	■		■	■		■													
WNMG060412-MF1 WNMP333-MF1	1,2 0.047	9,525 0.375	6,5 0.256	4,76 0.187	3,81 0.150	80,0	0,0													■						
WNMG060412-MF2 WNMG333-MF2	1,2 0.047	9,525 0.375	6,5 0.256	4,76 0.187	3,81 0.150	80,0	0,0				■															
WNMG060412-MF4 WNMG333-MF4	1,2 0.047	9,525 0.375	6,52 0.257	4,76 0.187	3,81 0.150	80,0	0,0					■	■	■												
WNMG060412-MF5 WNMG333-MF5	1,2 0.047	9,525 0.375	6,5 0.256	4,76 0.187	3,81 0.150	80,0	0,0		■	■																
WNMG060412-MR3 WNMG333-MR3	1,2 0.047	9,525 0.375	6,5 0.256	4,76 0.187	3,81 0.150	80,0	0,0													■	■					
WNGG080401-MF1 WNGP430-MF1	0,1 0.004	12,7 0.500	8,7 0.343	4,76 0.187	5,15 0.203	80,0	0,0													■						
WNGG080402-MF1 WNGP430.5-MF1	0,2 0.008	12,7 0.500	8,7 0.343	4,76 0.187	5,15 0.203	80,0	0,0													■						
WNGG080404-MF1 WNGP431-MF1	0,4 0.016	12,7 0.500	8,7 0.343	4,76 0.187	5,15 0.203	80,0	0,0													■						
WNMG080404-FF2 WNMG431-FF2	0,4 0.016	12,7 0.500	8,7 0.343	4,76 0.187	5,15 0.203	80,0	0,0		■	■																
WNMG080404-M1 WNMP431-M1	0,4 0.016	12,7 0.500	8,7 0.343	4,76 0.187	5,15 0.203	80,0	0,0																		■	
WNMG080404-M3 WNMG431-M3	0,4 0.016	12,7 0.500	8,7 0.343	4,76 0.187	5,15 0.203	80,0	0,0		■	■	■	■														
WNMG080404-MF1 WNMP431-MF1	0,4 0.016	12,7 0.500	8,7 0.343	4,76 0.187	5,15 0.203	80,0	0,0						■	■	■											
WNMG080404-MF2 WNMG431-MF2	0,4 0.016	12,7 0.500	8,7 0.343	4,76 0.187	5,15 0.203	80,0	0,0		■	■																
WNMG080404W-MF2 WNMG431W-MF2	0,4 0.016	12,7 0.500	8,7 0.343	4,76 0.187	5,15 0.203	80,0	0,0				■															
WNMG080404-MF3 WNMG431-MF3	0,4 0.016	12,7 0.500	8,7 0.343	4,76 0.187	5,15 0.203	80,0	0,0						■													
WNMG080404-MF4 WNMG431-MF4	0,4 0.016	12,7 0.500	8,69 0.342	4,76 0.187	5,15 0.203	80,0	0,0						■	■	■											

General ISO Turning Inserts
Steadyline[®]
MDT
Mini-Shaft™
Grooving
Parting-off
X4
Adapters Clamping units
Accessories and Spare parts
Workpiece materials

General ISO Turning Inserts	Cemented Carbide and Cermet Grades																																
	Designation	RE	IC	L	S	D1	EPSR°	AN°	Coated																		Uncoated		Cermet				
									TP0501	TP1501	TP2501	TP3501	TP25	TP40	TM1501	TM2501	TM3501	TK0501	TK1501	TS2000	TS2050	TS2500	TH1000	TH1500	CP200	CP500	CP600	HX	KX	883	890	TP1030	TP1020
									mm Inch	mm Inch	mm Inch	mm Inch	mm Inch																				
WNGG080408-MF1 WNGP432-MF1	0,8 0.031	12,7 0.500	8,7 0.343	4,76 0.187	5,15 0.203	80,0	0,0																										
WNMA080408-MR9 WNMA432-MR9	0,8 0.031	12,7 0.500	8,69 0.342	4,76 0.187	5,15 0.203	80,0	0,0																										
WNMA080408 WNMA432	0,8 0.031	12,7 0.500	8,7 0.343	4,76 0.187	5,15 0.203	80,0	0,0																										
WNMG080408-FF2 WNMG432-FF2	0,8 0.031	12,7 0.500	8,7 0.343	4,76 0.187	5,15 0.203	80,0	0,0																										
WNMG080408-M1 WNMP432-M1	0,8 0.031	12,7 0.500	8,7 0.343	4,76 0.187	5,15 0.203	80,0	0,0																										
WNMG080408-M3 WNMG432-M3	0,8 0.031	12,7 0.500	8,7 0.343	4,76 0.187	5,15 0.203	80,0	0,0																										
WNMG080408W-M3 WNMG432W-M3	0,8 0.031	12,7 0.500	8,7 0.343	4,76 0.187	5,15 0.203	80,0	0,0																										
WNMG080408-M4 WNMG432-M4	0,8 0.031	12,7 0.500	8,7 0.343	4,76 0.187	5,15 0.203	80,0	0,0																										
WNMG080408-M5 WNMG432-M5	0,8 0.031	12,7 0.500	8,7 0.343	4,76 0.187	5,15 0.203	80,0	0,0																										
WNMG080408-M6 WNMG432-M6	0,8 0.031	12,7 0.500	8,7 0.343	4,76 0.187	5,15 0.203	80,0	0,0																										
WNMG080408W-M6 WNMG432W-M6	0,8 0.031	12,7 0.500	8,7 0.343	4,76 0.187	5,15 0.203	80,0	0,0																										
WNMG080408-MF1 WNMP432-MF1	0,8 0.031	12,7 0.500	8,7 0.343	4,76 0.187	5,15 0.203	80,0	0,0																										
WNMG080408-MF2 WNMG432-MF2	0,8 0.031	12,7 0.500	8,7 0.343	4,76 0.187	5,15 0.203	80,0	0,0																										
WNMG080408W-MF2 WNMG432W-MF2	0,8 0.031	12,7 0.500	8,7 0.343	4,76 0.187	5,15 0.203	80,0	0,0																										
WNMG080408-MF3 WNMG432-MF3	0,8 0.031	12,7 0.500	8,7 0.343	4,76 0.187	5,15 0.203	80,0	0,0																										
WNMG080408-MF4 WNMG432-MF4	0,8 0.031	12,7 0.500	8,7 0.343	4,76 0.187	5,15 0.203	80,0	0,0																										
WNMG080408W-MF4 WNMG432W-MF4	0,8 0.031	12,7 0.500	8,69 0.342	4,76 0.187	5,15 0.203	80,0	0,0																										
WNMG080408-MF5 WNMG432-MF5	0,8 0.031	12,7 0.500	8,7 0.343	4,76 0.187	5,15 0.203	80,0	0,0																										
WNMG080408W-MF5 WNMG432W-MF5	0,8 0.031	12,7 0.500	8,7 0.343	4,76 0.187	5,15 0.203	80,0	0,0																										
WNMG080408-MR6 WNMG432-MR6	0,8 0.031	12,7 0.500	8,7 0.343	4,76 0.187	5,15 0.203	80,0	0,0																										
WNMG080408-MR7 WNMG432-MR7	0,8 0.031	12,7 0.500	8,7 0.343	4,76 0.187	5,15 0.203	80,0	0,0																										
WNMM080408-R6 WNMM432-R6	0,8 0.031	12,7 0.500	8,7 0.343	4,76 0.187	5,15 0.203	80,0	0,0																										
WNMA080412-MR9 WNMA433-MR9	1,2 0.047	12,7 0.500	8,69 0.342	4,76 0.187	5,15 0.203	80,0	0,0																										
WNMA080412 WNMA433	1,2 0.047	12,7 0.500	8,7 0.343	4,76 0.187	5,15 0.203	80,0	0,0																										
WNMG080412-M3 WNMG433-M3	1,2 0.047	12,7 0.500	8,7 0.343	4,76 0.187	5,15 0.203	80,0	0,0																										
WNMG080412W-M3 WNMG433W-M3	1,2 0.047	12,7 0.500	8,7 0.343	4,76 0.187	5,15 0.203	80,0	0,0																										
WNMG080412-M4 WNMG433-M4	1,2 0.047	12,7 0.500	8,7 0.343	4,76 0.187	5,15 0.203	80,0	0,0																										
WNMG080412-M5 WNMG433-M5	1,2 0.047	12,7 0.500	8,7 0.343	4,76 0.187	5,15 0.203	80,0	0,0																										
WNMG080412-M6 WNMG433-M6	1,2 0.047	12,7 0.500	8,7 0.343	4,76 0.187	5,15 0.203	80,0	0,0																										
WNMG080412W-M6 WNMG433W-M6	1,2 0.047	12,7 0.500	8,7 0.343	4,76 0.187	5,15 0.203	80,0	0,0																										

Designation	RE	IC	L	S	D1	EPR [®]	AN [°]	Cemented Carbide and Cermet Grades																		
								Coated											Uncoated				Cermet			
								TP0501	TP1501	TP2501	TP3501	TP25	TP40	TM1501	TM2501	TM3501	TK0501	TK1501	TS2000	TS2050	TS2500	TH1000	TH1500	CP200	CP500	CP600
mm Inch	mm Inch	mm Inch	mm Inch	mm Inch																						
WNMG080412-MF2 WNMG433-MF2	1,2 0.047	12,7 0.500	8,7 0.343	4,76 0.187	5,15 0.203	80,0	0,0		■																	
WNMG080412-MF4 WNMG433-MF4	1,2 0.047	12,7 0.500	8,7 0.343	4,76 0.187	5,15 0.203	80,0	0,0			■	■			■												
WNMG080412W-MF4 WNMG433W-MF4	1,2 0.047	12,7 0.500	8,69 0.342	4,76 0.187	5,15 0.203	80,0	0,0							■												
WNMG080412-MF5 WNMG433-MF5	1,2 0.047	12,7 0.500	8,7 0.343	4,76 0.187	5,15 0.203	80,0	0,0	■	■	■					■											
WNMG080412-MR6 WNMG433-MR6	1,2 0.047	12,7 0.500	8,7 0.343	4,76 0.187	5,15 0.203	80,0	0,0		■																	
WNMG080412-MR7 WNMG433-MR7	1,2 0.047	12,7 0.500	8,7 0.343	4,76 0.187	5,15 0.203	80,0	0,0		■	■	■	■			■											
WNMM080412-R6 WNMM433-R6	1,2 0.047	12,7 0.500	8,7 0.343	4,76 0.187	5,15 0.203	80,0	0,0								■											
WNMA080416-MR9 WNMA434-MR9	1,6 0.063	12,7 0.500	8,69 0.342	4,76 0.187	5,15 0.203	80,0	0,0																			
WNMA080416 WNMA434	1,6 0.063	12,7 0.500	8,7 0.343	4,76 0.187	5,15 0.203	80,0	0,0																			
WNMG080416-M3 WNMG434-M3	1,6 0.063	12,7 0.500	8,7 0.343	4,76 0.187	5,15 0.203	80,0	0,0				■															
WNMG080416-M5 WNMG434-M5	1,6 0.063	12,7 0.500	8,7 0.343	4,76 0.187	5,15 0.203	80,0	0,0	■	■	■	■	■			■											
WNMG080416-M6 WNMG434-M6	1,6 0.063	12,7 0.500	8,7 0.343	4,76 0.187	5,15 0.203	80,0	0,0	■	■	■	■				■											
WNMG080416-MF5 WNMG434-MF5	1,6 0.063	12,7 0.500	8,7 0.343	4,76 0.187	5,15 0.203	80,0	0,0				■															
WNMG080416-MR7 WNMG434-MR7	1,6 0.063	12,7 0.500	8,7 0.343	4,76 0.187	5,15 0.203	80,0	0,0		■	■	■															
WNMG080608-M5 WNMG442-M5	0,8 0.031	12,7 0.500	8,7 0.343	6,35 0.250	5,15 0.203	80,0	0,0				■															
WNMG080612-M5 WNMG443-M5	1,2 0.047	12,7 0.500	8,7 0.343	6,35 0.250	5,15 0.203	80,0	0,0		■	■	■				■											
WNMG080612-M6 WNMG443-M6	1,2 0.047	12,7 0.500	8,7 0.343	6,35 0.250	5,15 0.203	80,0	0,0	■	■	■	■					■										
WNMG080616-M5 WNMG444-M5	1,6 0.063	12,7 0.500	8,7 0.343	6,35 0.250	5,15 0.203	80,0	0,0		■	■	■				■											
WNMG080616-M6 WNMG444-M6	1,6 0.063	12,7 0.500	8,7 0.343	6,35 0.250	5,15 0.203	80,0	0,0		■							■										

General ISO Turning Inserts

Steadyline[®]

MDT

Mini-Shaft™

Grooving

Parting-off

X4

Adapters
Clamping units

Accessories and
Spare parts

Workpiece
materials

- General ISO Turning Inserts
- Steadyline®
- MDT
- Mini-Shaft™
- Grooving
- Parting-off
- X4
- Adapters Clamping units
- Accessories and Spare parts
- Workpiece materials



PCBN, PCD, Ceramics

Our team of advanced cutting materials experts is continuously looking for new ways to use PCBN, PCD and ceramics to develop Secomax™ cutting tools that bring exceptional productivity and tool life to the machining of difficult, highly abrasive materials.

- PCBN (Polycrystalline Cubic Boron Nitride), advanced cutting material.
- PCD (Polycrystalline Diamond), level of hardness that is comparable to natural diamond.
- Ceramics, we have three grades that offer optimized wear resistance and toughness.

CCGW

Tip sizes, see page(s) 134
Edge preparation, see page(s) 131

Tolerances:
IC = ±0,025/0.001
S = ±0,13/0.005
RE = ±0,1/0.004

Please check availability at www.secotools.com/
Seco Online Store

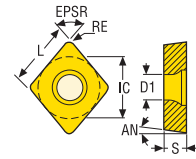

CCGW...-B

CCGW...-LF



Designation	RE	IC	L	S	W1	EPSR°	AN°	Grades														
								Coated						Uncoated								
	mm Inch	mm Inch	mm Inch	mm Inch	mm Inch			CH0550	CBN060K	CH2540	CH3515	CBN300P	CK2065	CBN400C	CBN010	CBN150	CBN170	CBN200	CBN300	CBN500	CBN600	
CCGW060204E-L1-B CCGW21.51E-L1-B	0,4 0.016	6,35 0.250	6,5 0.256	2,38 0.094	2,9 0.114	80,0	7,0		■						■			■				
CCGW060208E-L1-B CCGW21.52E-L1-B	0,8 0.031	6,35 0.250	6,5 0.256	2,38 0.094	2,9 0.114	80,0	7,0											■				
CCGW060204S-01020-L1-B CCGW21.51S-00420-L1-B	0,4 0.016	6,35 0.250	6,5 0.256	2,38 0.094	2,9 0.114	80,0	7,0								■							
CCGW060204S-01525-L1-B CCGW21.51S-00625-L1-B	0,4 0.016	6,35 0.250	6,5 0.256	2,38 0.094	2,9 0.114	80,0	7,0	■	■													
CCGW060208S-01525-L1-B CCGW21.52S-00625-L1-B	0,8 0.031	6,35 0.250	6,5 0.256	2,38 0.094	2,9 0.114	80,0	7,0			■												
CCGW060208S-02020-L1-B CCGW21.52S-00820-L1-B	0,8 0.031	6,35 0.250	6,5 0.256	2,38 0.094	2,9 0.114	80,0	7,0				■							■				
CCGW060202S-01020-LF CCGW21.50.5S-00420-LF	0,2 0.008	6,35 0.250	6,5 0.256	2,38 0.094	2,9 0.114	80,0	7,0											■				
CCGW060204S-01020-LF CCGW21.51S-00420-LF	0,4 0.016	6,35 0.250	6,5 0.256	2,38 0.094	2,9 0.114	80,0	7,0								■			■				
CCGW060208S-01020-LF CCGW21.52S-00420-LF	0,8 0.031	6,35 0.250	6,5 0.256	2,38 0.094	2,9 0.114	80,0	7,0											■				
CCGW060208S-L1-WZP-B CCGW21.52S-L1-WZP-B	0,8 0.031	6,35 0.250	6,5 0.256	2,38 0.094	2,9 0.114	80,0	7,0	■	■													
CCGW09T304E-L1-B CCGW32.51E-L1-B	0,4 0.016	9,525 0.375	9,7 0.382	3,97 0.156	4,5 0.177	80,0	7,0		■						■			■				
CCGW09T308E-L1-B CCGW32.52E-L1-B	0,8 0.031	9,525 0.375	9,7 0.382	3,97 0.156	4,5 0.177	80,0	7,0								■			■				
CCGW09T304S-01020-L1-B CCGW32.51S-00420-L1-B	0,4 0.016	9,525 0.375	9,7 0.382	3,97 0.156	4,5 0.177	80,0	7,0								■							
CCGW09T304S-01525-L1-B CCGW32.51S-00625-L1-B	0,4 0.016	9,525 0.375	9,7 0.382	3,97 0.156	4,5 0.177	80,0	7,0	■	■													
CCGW09T308S-01020-L1-B CCGW32.52S-00420-L1-B	0,8 0.031	9,525 0.375	9,7 0.382	3,97 0.156	4,5 0.177	80,0	7,0								■	■						
CCGW09T308S-01525-L1-B CCGW32.52S-00625-L1-B	0,8 0.031	9,525 0.375	9,7 0.382	3,97 0.156	4,5 0.177	80,0	7,0		■	■												
CCGW09T308S-02020-L1-B CCGW32.52S-00820-L1-B	0,8 0.031	9,525 0.375	9,7 0.382	3,97 0.156	4,5 0.177	80,0	7,0				■							■				
CCGW09T304S25-02020-L1B CCGW32.51S25-00820-L1-B	0,4 0.016	9,525 0.375	9,7 0.382	3,97 0.156	4,5 0.177	80,0	7,0											■				
CCGW09T308S25-02020-L1B CCGW32.52S25-00820-L1-B	0,8 0.031	9,525 0.375	9,7 0.382	3,97 0.156	4,5 0.177	80,0	7,0											■				
CCGW09T304S-01020-LF CCGW32.51S-00420-LF	0,4 0.016	9,525 0.375	9,7 0.382	3,97 0.156	4,5 0.177	80,0	7,0								■			■				
CCGW09T308S-01020-LF CCGW32.52S-00420-LF	0,8 0.031	9,525 0.375	9,7 0.382	3,97 0.156	4,5 0.177	80,0	7,0											■				
CCGW09T304S-01020-L1WZB CCGW32.51S-00420-L1-WZ-B	0,4 0.016	9,525 0.375	9,7 0.382	3,97 0.156	4,5 0.177	80,0	7,0								■							

General ISO Turning Inserts
Steadyline®
MDT
Mini-Shaft™
Grooving
Parting-off
X4
Adapters Clamping units
Accessories and Spare parts
Workpiece materials

General ISO Turning Inserts	Designation	RE	IC	L	S	W1	EPSR°	AN°	Grades															
									Coated						Uncoated									
									CH0550	CBN060K	CH2540	CH3515	CBN300P	CK2065	CBN400C	CBN010	CBN150	CBN170	CBN200	CBN300	CBN500	CBN600		
General ISO Turning Inserts	CCGW09T304S-01525L1WZB	0,4	9,525	9,7	3,97	4,5	80,0	7,0	■	■														
	CCGW32.51S-00625-L1-WZ-B	0.016	0.375	0.382	0.156	0.177																		
Steadyline®	CCGW09T308S-01525L1WZB	0,8	9,525	9,7	3,97	4,5	80,0	7,0		■														
	CCGW32.52S-00625-L1-WZ-B	0.031	0.375	0.382	0.156	0.177																		
Steadyline®	CCGW09T304S-L1-WZP-B	0,4	9,525	9,7	3,97	4,5	80,0	7,0	■	■														
	CCGW32.51S-L1-WZP-B	0.016	0.375	0.382	0.156	0.177																		
MDT	CCGW09T308S-L1-WZP-B	0,8	9,525	9,7	3,97	4,5	80,0	7,0		■														
	CCGW32.52S-L1-WZP-B	0.031	0.375	0.382	0.156	0.177																		
MDT	CCGW120404S-01020-L1-B	0,4	12,7	12,9	4,76	5,6	80,0	7,0									■							
	CCGW431S-00420-L1-B	0.016	0.500	0.508	0.187	0.220																		
MDT	CCGW120408S-01020-L1-B	0,8	12,7	12,9	4,76	5,6	80,0	7,0									■							
	CCGW432S-00420-L1-B	0.031	0.500	0.508	0.187	0.220																		
MDT	CCGW120408S-02020-L1-B	0,8	12,7	12,9	4,76	5,6	80,0	7,0										■						
	CCGW432S-00820-L1-B	0.031	0.500	0.508	0.187	0.220																		

CNGA

Tip sizes, see page(s) 134
Edge preparation, see page(s) 131

Tolerances:
IC = ±0,025/0,001
S = ±0,13/0,005
RE = ±0,1/0,004

Please check availability at www.secotools.com/
Seco Online Store

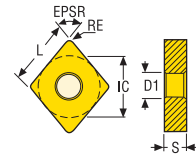

CNGA...-B

CNGA...-U

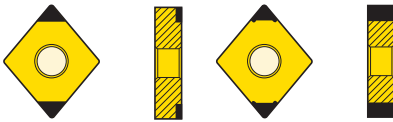

Designation	RE	IC	L	S	W1	EPSR°	AN°	Grades															
								Coated						Uncoated									
	mm Inch	mm Inch	mm Inch	mm Inch	mm Inch			CH0550	CBN060K	CH2540	CH3515	CBN300P	CK2065	CBN400C	CBN010	CBN150	CBN170	CBN200	CBN300	CBN500	CBN600		
CNGA120408E-L1-B CNGA432E-L1-B	0,8 0.031	12,7 0.500	12,9 0.508	4,76 0.187	5,15 0.203	80,0	0,0											■					
CNGA120404S-01020-L1-B CNGA431S-00420-L1-B	0,4 0.016	12,7 0.500	12,9 0.508	4,76 0.187	5,15 0.203	80,0	0,0								■								
CNGA120404S-01525-L1-B CNGA431S-00625-L1-B	0,4 0.016	12,7 0.500	12,896 0.508	4,76 0.187	5,15 0.203	80,0	0,0	■															
CNGA120404S-02020-L1-B CNGA431S-00820-L1-B	0,4 0.016	12,7 0.500	12,9 0.508	4,76 0.187	5,15 0.203	80,0	0,0				■												
CNGA120408S-01020-L1-B CNGA432S-00420-L1-B	0,8 0.031	12,7 0.500	12,9 0.508	4,76 0.187	5,15 0.203	80,0	0,0								■								
CNGA120408S-01525-L1-B CNGA432S-00625-L1-B	0,8 0.031	12,7 0.500	12,9 0.508	4,76 0.187	5,15 0.203	80,0	0,0	■	■	■						■							
CNGA120408S-02020-L1-B CNGA432S-00820-L1-B	0,8 0.031	12,7 0.500	12,9 0.508	4,76 0.187	5,15 0.203	80,0	0,0				■							■					
CNGA120412S-01020-L1-B CNGA433S-00420-L1-B	1,2 0.047	12,7 0.500	12,9 0.508	4,76 0.187	5,15 0.203	80,0	0,0								■								
CNGA120412S-01525-L1-B CNGA433S-00625-L1-B	1,2 0.047	12,7 0.500	12,9 0.508	4,76 0.187	5,15 0.203	80,0	0,0	■	■	■						■							
CNGA120412S-02020-L1-B CNGA433S-00820-L1-B	1,2 0.047	12,7 0.500	12,9 0.508	4,76 0.187	5,15 0.203	80,0	0,0				■												
CNGA120408S25-02020-L1B CNGA432S25-00820-L1-B	0,8 0.031	12,7 0.500	12,9 0.508	4,76 0.187	5,15 0.203	80,0	0,0											■					
CNGA120408E25-L1-U CNGA432E25-L1-U	0,8 0.031	12,7 0.500	12,9 0.508	4,76 0.187	5,15 0.203	80,0	0,0											■					
CNGA120404S-01525-L1-U CNGA431S-00625-L1-U	0,4 0.016	12,7 0.500	12,9 0.508	4,76 0.187	5,15 0.203	80,0	0,0		■														
CNGA120408S-01020-L1-U CNGA432S-00420-L1-U	0,8 0.031	12,7 0.500	12,9 0.508	4,76 0.187	5,15 0.203	80,0	0,0								■								
CNGA120408S-01525-L1-U CNGA432S-00625-L1-U	0,8 0.031	12,7 0.500	12,9 0.508	4,76 0.187	5,15 0.203	80,0	0,0		■														
CNGA120412S-01525-L1-U CNGA433S-00625-L1-U	1,2 0.047	12,7 0.500	12,9 0.508	4,76 0.187	5,15 0.203	80,0	0,0	■	■							■							
CNGA120404S-02020-L1WZB CNGA431S-00820-L1-WZ-B	0,4 0.016	12,7 0.500	12,9 0.508	4,76 0.187	5,15 0.203	80,0	0,0				■												
CNGA120408S-01020-L1WZB CNGA432S-00420-L1-WZ-B	0,8 0.031	12,7 0.500	12,9 0.508	4,76 0.187	5,15 0.203	80,0	0,0								■								
CNGA120408S-01525L1WZB CNGA432S-00625-L1-WZ-B	0,8 0.031	12,7 0.500	12,9 0.508	4,76 0.187	5,15 0.203	80,0	0,0	■	■	■													
CNGA120408S01525L1WLB CNGA432S00625L1WLB	0,8 0.031	12,7 0.500	12,9 0.508	4,76 0.187	5,15 0.203	80,0	0,0		■														
CNGA120408S01525L1WSB CNGA432S00625L1WSB	0,8 0.031	12,7 0.500	12,9 0.508	4,76 0.187	5,15 0.203	80,0	0,0		■														
CNGA120412S-01525L1WZB CNGA433S-00625-L1-WZ-B	1,2 0.047	12,7 0.500	12,9 0.508	4,76 0.187	5,15 0.203	80,0	0,0				■												

General ISO Turning Inserts
Steadyline®
MDT
Mini-Shaft™
Grooving
Parting-off
X4
Adapters Clamping units
Accessories and Spare parts
Workpiece materials

General ISO Turning Inserts	Designation	RE	IC	L	S	W1	EPSR°	AN°	Grades																
									Coated						Uncoated										
									CH0550	CBN060K	CH2540	CH3515	CBN300P	CK2065	CBN400C	CBN010	CBN150	CBN170	CBN200	CBN300	CBN500	CBN600			
mm Inch	mm Inch	mm Inch	mm Inch	mm Inch																					
General ISO Turning Inserts	CNGA120408S-01020-L1WZU	0,8	12,7	12,9	4,76	5,15	80,0	0,0									■								
	CNGA432S-00420-L1-WZ-U	0.031	0.500	0.508	0.187	0.203																			
Steadyline®	CNGA120408S-01525L1WZU	0,8	12,7	12,9	4,76	5,15	80,0	0,0		■															
	CNGA432S-00625-L1-WZ-U	0.031	0.500	0.508	0.187	0.203																			
Steadyline®	CNGA120412S-01525L1WZU	1,2	12,7	12,9	4,76	5,15	80,0	0,0		■															
	CNGA433S-00625-L1-WZ-U	0.047	0.500	0.508	0.187	0.203																			
MDT	CNGA120408S-L1-WZN-B	0,8	12,7	12,9	4,76	5,15	80,0	0,0		■															
	CNGA432S-L1-WZN-B	0.031	0.500	0.508	0.187	0.203																			
MDT	CNGA120408S-L1-WZN-U	0,8	12,7	12,9	4,76	5,15	80,0	0,0		■															
	CNGA432S-L1-WZN-U	0.031	0.500	0.508	0.187	0.203																			
MDT	CNGA120408S-L1-WZP-B	0,8	12,7	12,9	4,76	5,15	80,0	0,0		■							■								
	CNGA432S-L1-WZP-B	0.031	0.500	0.508	0.187	0.203																			

Tip sizes, see page(s) 134
Edge preparation, see page(s) 131

Tolerances: Size:
IC = ±0,05/0.002 09/3
IC = ±0,08/0.003 12/4
S = ±0,13/0.005
RE = ±0,1/0.004

Please check availability at www.secotools.com/
Seco Online Store

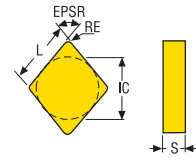

CNMN

General ISO Turning
Inserts

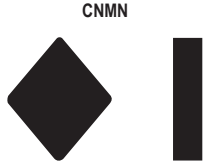

Steadyline®

Designation	RE	IC	L	S	EPSR°	AN°	Grades														
							Coated					Uncoated									
	mm Inch	mm Inch	mm Inch	mm Inch			CH0550	CBN060K	CH2540	CH3515	CBN300P	CK2065	CBN400C	CBN010	CBN150	CBN170	CBN200	CBN300	CBN500	CBN600	
CNMN090308S CNMN322S	0,8 0.031	9,525 0.375	9,7 0.382	3,18 0.125	80,0	-												■			
CNMN090308S-02020 CNMN322S-00820	0,8 0.031	9,525 0.375	9,7 0.382	3,18 0.125	80,0	-							■							■	
CNMN090308S-02020P CNMN322S-00820	0,8 0.031	9,525 0.375	9,7 0.382	3,18 0.125	80,0	-															■
CNMN090312S-02020 CNMN323S-00820	1,2 0.047	9,525 0.375	9,67 0.381	3,18 0.125	80,0	-						■									
CNMN090312S CNMN323S	1,2 0.047	9,525 0.375	9,7 0.382	3,18 0.125	80,0	-					■								■		
CNMN090316S CNMN324S	1,6 0.063	9,525 0.375	9,7 0.382	3,18 0.125	80,0	-					■								■		
CNMN090308S-WZ CNMN322S-WZ	0,8 0.031	9,525 0.375	9,7 0.382	3,18 0.125	80,0	-													■		
CNMN120412S CNMN433S	1,2 0.047	12,7 0.500	12,9 0.508	4,76 0.187	80,0	-					■								■		
CNMN120412S-02020 CNMN433S-00820	1,2 0.047	12,7 0.500	12,9 0.508	4,76 0.187	80,0	-						■									
CNMN120412S-02020P CNMN433S-00820P	1,2 0.047	12,7 0.500	12,9 0.508	4,76 0.187	80,0	-															■
CNMN120416S CNMN434S	1,6 0.063	12,7 0.500	12,9 0.508	4,76 0.187	80,0	-													■		
CNMN120416S-02020P CNMN434S-00820P	1,6 0.063	12,7 0.500	12,9 0.508	4,76 0.187	80,0	-															■
CNMN120408S-WZ CNMN432S-WZ	0,8 0.031	12,7 0.500	12,9 0.508	4,76 0.187	80,0	-													■		

MDT

Mini-Shaft™

Grooving

Parting-off

X4

Adapters
Clamping units

Accessories and
Spare parts

Workpiece
materials

DCGW

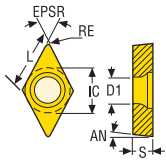

Tolerances:
IC = $\pm 0,025/0,001$
S = $\pm 0,13/0,005$
RE = $\pm 0,1/0,004$

Tip sizes, see page(s) 134
Edge preparation, see page(s) 131

Please check availability at www.secotools.com /
Seco Online Store

DCGW...-B

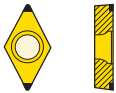

Designation	RE	IC	L	S	W1	EPSR°	AN°	Grades														
								Coated					Uncoated									
	mm Inch	mm Inch	mm Inch	mm Inch	mm Inch			CH0550	CBN060K	CH2540	CH3515	CBN300P	CK2065	CBN400C	CBN010	CBN150	CBN170	CBN200	CBN300	CBN500	CBN600	
DCGW070204E-L1-B DCGW21.51E-L1-B	0,4 0.016	6,35 0.250	7,8 0.307	2,38 0.094	2,9 0.114	55,0	7,0								■			■				
DCGW070202S-01020-L1-B DCGW21.50.5S-00420-L1-B	0,2 0.008	6,35 0.250	7,8 0.307	2,38 0.094	2,9 0.114	55,0	7,0									■						
DCGW070202S-01525-L1-B DCGW21.50.5S-00625-L1-B	0,2 0.008	6,35 0.250	7,8 0.307	2,38 0.094	2,9 0.114	55,0	7,0			■												
DCGW070204S-01020-L1-B DCGW21.51S-00420-L1-B	0,4 0.016	6,35 0.250	7,8 0.307	2,38 0.094	2,9 0.114	55,0	7,0								■	■						
DCGW070204S-01525-L1-B DCGW21.51S-00625-L1-B	0,4 0.016	6,35 0.250	7,8 0.307	2,38 0.094	2,9 0.114	55,0	7,0			■												
DCGW070204S-02020-L1-B DCGW21.51S-00820-L1-B	0,4 0.016	6,35 0.250	7,8 0.307	2,38 0.094	2,9 0.114	55,0	7,0											■				
DCGW070208S-01525-L1-B DCGW21.52S-00625-L1-B	0,8 0.031	6,35 0.250	7,8 0.307	2,38 0.094	2,9 0.114	55,0	7,0			■												
DCGW070208S-02020-L1-B DCGW21.52S-00820-L1-B	0,8 0.031	6,35 0.250	7,8 0.307	2,38 0.094	2,9 0.114	55,0	7,0											■				
DCGW070204S25-02020-L1B DCGW21.51S25-00820-L1-B	0,4 0.016	6,35 0.250	7,8 0.307	2,38 0.094	2,9 0.114	55,0	7,0											■				
DCGW11T302E-L1-B DCGW32.50E-L1-B	0,2 0.008	9,525 0.375	11,6 0.457	3,97 0.156	4,5 0.177	55,0	7,0											■				
DCGW11T304E-L1-B DCGW32.51E-L1-B	0,4 0.016	9,525 0.375	11,6 0.457	3,97 0.156	4,5 0.177	55,0	7,0								■							
DCGW11T308E-L1-B DCGW32.52E-L1-B	0,8 0.031	9,525 0.375	11,6 0.457	3,97 0.156	4,5 0.177	55,0	7,0								■							
DCGW11T302S-01020-L1-B DCGW32.50S-00420-L1-B	0,2 0.008	9,525 0.375	11,6 0.457	3,97 0.156	4,5 0.177	55,0	7,0								■							
DCGW11T304S-01020-L1-B DCGW32.51S-00420-L1-B	0,4 0.016	9,525 0.375	11,6 0.457	3,97 0.156	4,5 0.177	55,0	7,0								■							
DCGW11T304S-01525-L1-B DCGW32.51S-00625-L1-B	0,4 0.016	9,525 0.375	11,6 0.457	3,97 0.156	4,5 0.177	55,0	7,0	■	■	■												
DCGW11T304S-02020-L1-B DCGW32.51S-00820-L1-B	0,4 0.016	9,525 0.375	11,6 0.457	3,97 0.156	4,5 0.177	55,0	7,0				■							■				
DCGW11T308S-01020-L1-B DCGW32.52S-00420-L1-B	0,8 0.031	9,525 0.375	11,6 0.457	3,97 0.156	4,5 0.177	55,0	7,0								■							
DCGW11T308S-01525-L1-B DCGW32.52S-00625-L1-B	0,8 0.031	9,525 0.375	11,6 0.457	3,97 0.156	4,5 0.177	55,0	7,0	■	■	■												
DCGW11T308S-02020-L1-B DCGW32.52S-00820-L1-B	0,8 0.031	9,525 0.375	11,6 0.457	3,97 0.156	4,5 0.177	55,0	7,0				■							■				
DCGW11T304S25-02020-L1B DCGW32.51S25-00820-L1-B	0,4 0.016	9,525 0.375	11,6 0.457	3,97 0.156	4,5 0.177	55,0	7,0											■				

DNGA

Tip sizes, see page(s) 134
Edge preparation, see page(s) 131

Tolerances:
IC = ±0,025/0.001
S = ±0,13/0.005
RE = ±0,1/0.004

Please check availability at www.secotools.com/
Seco Online Store

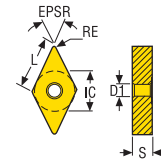

DNGA...-B

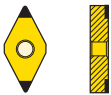

DNGA...-U



Designation	RE	IC	L	S	W1	EPSR°	AN°	Grades														
								Coated					Uncoated									
	mm Inch	mm Inch	mm Inch	mm Inch	mm Inch			CH0550	CBN060K	CH2540	CH3515	CBN300P	CK2065	CBN400C	CBN010	CBN150	CBN170	CBN200	CBN300	CBN500	CBN600	
DNGA150404S-01020-L1-B DNGA431S-00420-L1-B	0,4 0.016	12,7 0.500	15,0 0.591	4,76 0.187	5,15 0.203	55,0	-								■							
DNGA150408S-01020-L1-B DNGA432S-00420-L1-B	0,8 0.031	12,7 0.500	15,0 0.591	4,76 0.187	5,15 0.203	55,0	-								■							
DNGA150408S-01525-L1-B DNGA432S-00625-L1-B	0,8 0.031	12,7 0.500	15,0 0.591	4,76 0.187	5,15 0.203	55,0	-	■	■	■						■						
DNGA150408S-02020-L1-B DNGA432S-00820-L1-B	0,8 0.031	12,7 0.500	15,0 0.591	4,76 0.187	5,15 0.203	55,0	-				■							■				
DNGA150412S-01525-L1-B DNGA433S-00625-L1-B	1,2 0.047	12,7 0.500	15,0 0.591	4,76 0.187	5,15 0.203	55,0	-			■												
DNGA150412S-02020-L1-B DNGA433S-00820-L1-B	1,2 0.047	12,7 0.500	15,0 0.591	4,76 0.187	5,15 0.203	55,0	-				■											
DNGA150408S-01525-L1-U DNGA432S-00625-L1-U	0,8 0.031	12,7 0.500	15,0 0.591	4,76 0.187	5,15 0.203	55,0	-		■													
DNGA150408S-01525L1WZB DNGA432S-00625-L1-WZ-B	0,8 0.031	12,7 0.500	15,0 0.591	4,76 0.187	5,15 0.203	55,0	-	■														
DNGA150604S-01020-L1-B DNGA441S-00420-L1-B	0,4 0.016	12,7 0.500	15,0 0.591	6,35 0.250	5,15 0.203	55,0	-								■							
DNGA150608S-01020-L1-B DNGA442S-00420-L1-B	0,8 0.031	12,7 0.500	15,0 0.591	6,35 0.250	5,15 0.203	55,0	-								■							
DNGA150608S-01525-L1-B DNGA442S-00625-L1-B	0,8 0.031	12,7 0.500	15,0 0.591	6,35 0.250	5,15 0.203	55,0	-	■	■	■						■						
DNGA150608S-02020-L1-B DNGA442S-00820-L1-B	0,8 0.031	12,7 0.500	15,0 0.591	6,35 0.250	5,15 0.203	55,0	-											■				
DNGA150612S-01020-L1-B DNGA443S-00420-L1-B	1,2 0.047	12,7 0.500	15,0 0.591	6,35 0.250	5,15 0.203	55,0	-								■							
DNGA150612S-01525-L1-B DNGA443S-00625-L1-B	1,2 0.047	12,7 0.500	15,0 0.591	6,35 0.250	5,15 0.203	55,0	-			■												
DNGA150608E25-L1-U DNGA442E25-L1-U	0,8 0.031	12,7 0.500	15,0 0.591	6,35 0.250	5,15 0.203	55,0	-											■				
DNGA150604S-01525-L1-U DNGA441S-00625-L1-U	0,4 0.016	12,7 0.500	15,0 0.591	6,35 0.250	5,15 0.203	55,0	-		■													
DNGA150608S-01525-L1-U DNGA442S-00625-L1-U	0,8 0.031	12,7 0.500	15,0 0.591	6,35 0.250	5,15 0.203	55,0	-		■													
DNGA150612S-01525-L1-U DNGA443S-00625-L1-U	1,2 0.047	12,7 0.500	15,0 0.591	6,35 0.250	5,15 0.203	55,0	-		■													
DNGA150608S01020L1WZ93B DNGA442S-00420-L1-WZ-93-B	0,8 0.031	12,7 0.500	15,0 0.591	6,35 0.250	5,15 0.203	55,0	-								■							
DNGA150608S01525L1WZ93B DNGA442S-00625-L1-WZ93-B	0,8 0.031	12,7 0.500	15,0 0.591	6,35 0.250	5,15 0.203	55,0	-			■												

General ISO Turning
Inserts

Steadyline®

MDT

Mini-Shaft™

Grooving

Parting-off

X4

Adapters
Clamping units

Accessories and
Spare parts

Workpiece
materials

DNGN

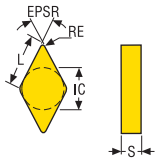

Tolerances:
IC = $\pm 0,025/0,001$
S = $\pm 0,13/0,005$
RE = $\pm 0,1/0,004$

Tip sizes, see page(s) 134
Edge preparation, see page(s) 131

Please check availability at www.secotools.com /
Seco Online Store

DNGN



General ISO Turning
Inserts

Steadyline®

MDT

Designation	RE	IC	L	S	EPSR°	AN°	Grades														
							Coated						Uncoated								
	mm Inch	mm Inch	mm Inch	mm Inch			CH0550	CBN060K	CH2540	CH3515	CBN300P	CK2065	CBN400C	CBN010	CBN150	CBN170	CBN200	CBN300	CBN500	CBN600	
DNGN110312S-01020	1,2	9,525	11,6	3,18	55,0	-								■							
DNGN323S-00420	0,047	0,375	0,457	0,125																	

Mini-Shaft™

DNMA

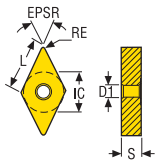

Tolerances:
IC = $\pm 0,05/0,002$
S = $\pm 0,13/0,005$
RE = $\pm 0,1/0,004$

Tip sizes, see page(s) 134
Edge preparation, see page(s) 131

Please check availability at www.secotools.com /
Seco Online Store

DNMA



Grooving

Parting-off

Designation	RE	IC	L	S	W1	EPSR°	AN°	Grades													
								Coated						Uncoated							
	mm Inch	mm Inch	mm Inch	mm Inch	mm Inch			CH0550	CBN060K	CH2540	CH3515	CBN300P	CK2065	CBN400C	CBN010	CBN150	CBN170	CBN200	CBN300	CBN500	CBN600
DNMA110408S	0,8	9,52	11,6	4,76	3,81	55,0	-												■		
DNMA332S	0,031	0,375	0,457	0,187	0,150																

X4

Adapters
Clamping units

Accessories and
Spare parts

Workpiece
materials

DNMN

Tip sizes, see page(s) 134
Edge preparation, see page(s) 131

Tolerances:
IC = $\pm 0,05/0.002$
S = $\pm 0,13/0.005$
RE = $\pm 0,1/0.004$

Please check availability at www.secotools.com /
Seco Online Store

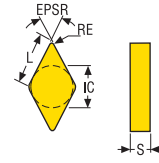

DNMN



Designation	RE	IC	L	S	EPSR°	AN°	Grades														
							Coated						Uncoated								
	mm Inch	mm Inch	mm Inch	mm Inch			CH0550	CBN060K	CH2540	CH3515	CBN300P	CK2065	CBN400C	CBN010	CBN150	CBN170	CBN200	CBN300	CBN500	CBN600	
DNMN110308S	0,8	9,525	11,6	3,18	55,0	-															
DNMN322S	0.031	0.375	0.457	0.125																	

Tip sizes, see page(s) 134
Edge preparation, see page(s) 131

Tolerances:
INSD = $\pm 0,025/0.001$
S = $\pm 0,13/0.005$

Please check availability at www.secotools.com /
Seco Online Store

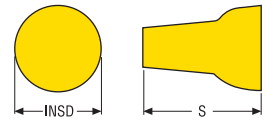

RCGS



Designation	INSD	IC	EPSR°	AN°	Grades													
					Coated						Uncoated							
	mm Inch	mm Inch			CH0550	CBN060K	CH2540	CH3515	CBN300P	CK2065	CBN400C	CBN010	CBN150	CBN170	CBN200	CBN300	CBN500	CBN600
RCGS6.35S-02020-LF	6,35	9,13		14,0														
RCGS2S-00820-LF	0.250	0.359																

General ISO Turning
Inserts

Steadyline®

MDT

Mini-Shaft™

Grooving

Parting-off

X4

Adapters
Clamping units

Accessories and
Spare parts

Workpiece
materials

RNGN-LF

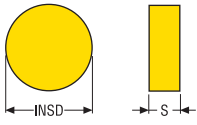

Tolerances:
INSD = $\pm 0,025/0.001$
S = $\pm 0,13/0.005$

Tip sizes, see page(s) 134
Edge preparation, see page(s) 131

Please check availability at www.secotools.com /
Seco Online Store

RNGN-LF



Designation	INSD	IC	EPSR°	AN°	Grades													
					Coated						Uncoated							
	mm Inch	mm Inch			CH0550	CBN060K	CH2540	CH3515	CBN300P	CK2065	CBN400C	CBN010	CBN150	CBN170	CBN200	CBN300	CBN500	CBN600
RNGN060300S-02020-LF RNGN22S-00820-LF	6,35 0.250	3,18 0.125	-	-				■							■			
RNGN090300S-02020-LF RNGN32S-00820-LF	9,52 0.375	3,18 0.125	-	0,0				■				■			■			
RNGN120400S-02020-LF RNGN43S-00820-LF	12,7 0.500	4,76 0.187	-	-											■			

RNGN

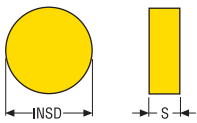

Tolerances:
INSD = $\pm 0,025/0.001$
S = $\pm 0,13/0.005$

Tip sizes, see page(s) 134
Edge preparation, see page(s) 131

Please check availability at www.secotools.com /
Seco Online Store

RNGN



Designation	INSD	IC	EPSR°	AN°	Grades													
					Coated						Uncoated							
	mm Inch	mm Inch			CH0550	CBN060K	CH2540	CH3515	CBN300P	CK2065	CBN400C	CBN010	CBN150	CBN170	CBN200	CBN300	CBN500	CBN600
RNGN060300E RNGN22E	6,35 0.250	3,18 0.125	-	-								■						
RNGN060300S RNGN22S	6,35 0.250	3,18 0.125	-	-											■			
RNGN060300S-01020 RNGN22S-00420	6,35 0.250	3,18 0.125	-	-								■						
RNGN060300S-01525 RNGN22S-00625	6,35 0.250	3,18 0.125	-	0,0	■	■	■						■					
RNGN090300E25 RNGN32E25	9,52 0.375	3,18 0.125	-	-										■				
RNGN090300S RNGN090300S	9,52 0.375	3,18 0.125	-	-											■			
RNGN090300S-01020 RNGN32S-00420	9,52 0.375	3,18 0.125	-	-								■						
RNGN090300S-01525 RNGN32S-00625	9,52 0.375	3,18 0.125	-	0,0	■	■	■						■					
RNGN120300S-01020 RNGN42S-00420	12,7 0.500	3,18 0.125	-	-								■						

Tip sizes, see page(s) 134
Edge preparation, see page(s) 131

Please check availability at www.secotools.com/
Seco Online Store

Tolerances: Size:
INSD = ±0,05/0.00206-09/2-3
INSD = ±0,08/0.003 12/4
INSD = ±0,10/0.004 19/6
INSD = ±0,13/0.005 25/8
S = ±0,13/0.005

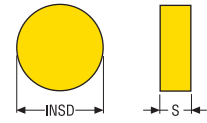

RNMN

RNMN



Designation	INSD	IC	EPSR°	AN°	Grades													
					Coated						Uncoated							
	mm Inch	mm Inch			CH0550	CBN060K	CH2540	CH3515	CBN300P	CK2065	CBN400C	CBN010	CBN150	CBN170	CBN200	CBN300	CBN500	CBN600
RNMN060300S RNMN22S	6,35 0.250	3,18 0.125	-	-					■							■		
RNMN060300S-02020 RNMN22S-00820	6,35 0.250	3,18 0.125	-	0,0						■								
RNMN060300S-02020P RNMN22S-00820P	6,35 0.250	3,18 0.125	-	-														■
RNMN090300E RNMN32E	9,52 0.375	3,18 0.125	-	-							■					■		
RNMN090300S RNMN32S	9,52 0.375	3,18 0.125	-	-					■							■		
RNMN090300S-02020 RNMN32S-00820	9,52 0.375	3,18 0.125	-	0,0						■	■						■	
RNMN090300S-02020P RNMN32S-00820P	9,52 0.375	3,18 0.125	-	-														■
RNMN120300E RNMN42E	12,7 0.500	3,18 0.125	-	-												■		
RNMN120300S RNMN42S	12,7 0.500	3,18 0.125	-	-					■							■		
RNMN120300S-02020 RNMN42S-00820	12,7 0.500	3,18 0.125	-	-													■	
RNMN120300S-02020P RNMN42S-00820P	12,7 0.500	3,18 0.125	-	-														■
RNMN120400S RNMN43S	12,7 0.500	4,76 0.187	-	-					■							■		
RNMN120400S-02020 RNMN43S-00820	12,7 0.500	4,76 0.187	-	0,0						■							■	
RNMN120400S-02020P RNMN43S-00820P	12,7 0.500	4,76 0.187	-	-														■
RNMN120400S-04015 RNMN43S-01515	12,7 0.500	4,76 0.187	-	-												■	■	
RNMN120400S-04015P RNMN43S-01515P	12,7 0.500	4,76 0.187	-	-														■
RNMN120400S25-07015P RNMN43S25-02815	12,7 0.500	4,76 0.187	-	-														■
RNMN120400X-05015 RNMN43X-02015	12,7 0.500	4,76 0.187	-	-													■	
RNMN190400S-10020 RNMN63S-04020	19,05 0.750	4,76 0.187	-	-													■	

General ISO Turning
Inserts

Steadyline®

MDT

Mini-Shaft™

Grooving

Parting-off

X4

Adapters
Clamping units

Accessories and
Spare parts

Workpiece
materials

SCGW

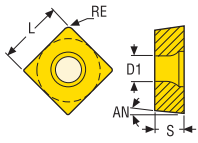

Tolerances:
L = $\pm 0,025/0.001$
S = $\pm 0,13/0.005$
RE = $\pm 0,1/0.004$

Tip sizes, see page(s) 134
Edge preparation, see page(s) 131

Please check availability at www.secotools.com /
Seco Online Store

SCGW



Designation	RE	L	S	EPSR°	AN°	Grades													
						Coated						Uncoated							
	mm Inch	mm Inch	mm Inch			CH0550	CBN060K	CH2540	CH3515	CBN300P	CK2065	CBN400C	CBN010	CBN150	CBN170	CBN200	CBN300	CBN500	CBN600
SCGW060208S-01020-LF	0,8 0.031	6,35 0.250	2,38 0.094	90,0	7,0											■			
SCGW21.52S-00420-LF																■			
SCGW09T304S-01020-LF	0,4 0.016	9,525 0.375	3,97 0.156	90,0	7,0											■			
SCGW32.51S-00420-LF																■			
SCGW09T308S-01020-LF	0,8 0.031	9,525 0.375	3,97 0.156	90,0	7,0											■			
SCGW32.52S-00420-LF																■			

SCMN

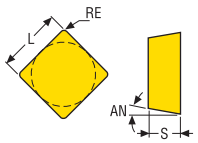

Tolerances:
L = $\pm 0,05/0.002$
S = $\pm 0,13/0.005$
RE = $\pm 0,1/0.004$

Tip sizes, see page(s) 134
Edge preparation, see page(s) 131

Please check availability at www.secotools.com /
Seco Online Store

SCMN



Designation	RE	L	S	EPSR°	AN°	Grades													
						Coated						Uncoated							
	mm Inch	mm Inch	mm Inch			CH0550	CBN060K	CH2540	CH3515	CBN300P	CK2065	CBN400C	CBN010	CBN150	CBN170	CBN200	CBN300	CBN500	CBN600
SCMN090408S-WZ-85	0,8 0.031	9,525 0.375	4,76 0.187	90,0	7,0												■		
SCMN332S-WZ-85																			

Tip sizes, see page(s) 134
Edge preparation, see page(s) 131

Please check availability at www.secotools.com/
Seco Online Store

Tolerances:
L = ±0,025/0.001
S = ±0,13/0.005
RE = ±0,1/0.004

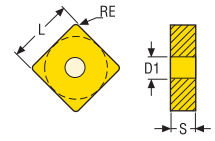

SNGA

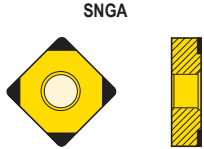

Designation	RE	L	S	W1	EPSR°	AN°	Grades														
							Coated					Uncoated									
	mm Inch	mm Inch	mm Inch	mm Inch			CH0550	CBN060K	CH2540	CH3515	CBN300P	CK2065	CBN400C	CBN010	CBN150	CBN170	CBN200	CBN300	CBN500	CBN600	
SNGA120408S-02020-L1-D	0,8	12,7	4,76	5,15	90,0	-											■				
SNGA432S-00820-L1-D	0.031	0.500	0.187	0.203																	

Tip sizes, see page(s) 134
Edge preparation, see page(s) 131

Please check availability at www.secotools.com/
Seco Online Store

Tolerances:
L = ±0,025/0.001
S = ±0,13/0.005
RE = ±0,1/0.004

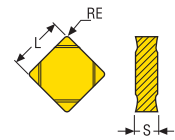

SNGF

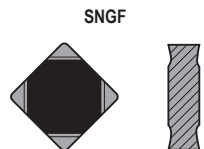

Designation	RE	L	S	EPSR°	AN°	Grades														
						Coated					Uncoated									
	mm Inch	mm Inch	mm Inch			CH0550	CBN060K	CH2540	CH3515	CBN300P	CK2065	CBN400C	CBN010	CBN150	CBN170	CBN200	CBN300	CBN500	CBN600	
SNGF090308E	0,8	9,525	3,18									■								
SNGF322E	0.031	0.375	0.125	90,0	-															
SNGF090312E	1,2	9,525	3,18									■								
SNGF323E	0.047	0.375	0.125	90,0	-															

General ISO Turning
Inserts

Steadyline®

MDT

Mini-Shaft™

Grooving

Parting-off

X4

Adapters
Clamping units

Accessories and
Spare parts

Workpiece
materials

SNGN

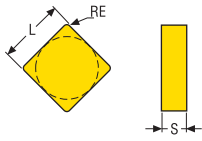

Tolerances:
L = ±0,025/0.001
S = ±0,13/0.005
RE = ±0,1/0.004

Tip sizes, see page(s) 134
Edge preparation, see page(s) 131

Please check availability at www.secotools.com /
Seco Online Store

SNGN



Designation	RE	L	S	EPSR°	AN°	Grades														
						Coated						Uncoated								
						CH0550	CBN060K	CH2540	CH3515	CBN300P	CK2065	CBN400C	CBN010	CBN150	CBN170	CBN200	CBN300	CBN500	CBN600	
SNGN060308S-01020 SNGN222S-00420	0,8 0.031	6,35 0.250	3,18 0.125	90,0	-									■						
SNGN090308E SNGN090308E	0,8 0.031	9,525 0.375	3,18 0.125	90,0	-												■			
SNGN090308S SNGN090308S	0,8 0.031	9,525 0.375	3,18 0.125	90,0	-												■			
SNGN090308S-01020 SNGN322S-00420	0,8 0.031	9,525 0.375	3,18 0.125	90,0	-									■						
SNGN090312S SNGN090312S	1,2 0.047	9,525 0.375	3,18 0.125	90,0	-												■			
SNGN090312S-01020 SNGN323S-00420	1,2 0.047	9,525 0.375	3,18 0.125	90,0	-									■						
SNGN090316S SNGN090316S	1,6 0.063	9,525 0.375	3,18 0.125	90,0	-												■			

General ISO Turning
Inserts

Steadyline®

MDT

Mini-Shaft™

Grooving

Parting-off

X4

Adapters
Clamping units

Accessories and
Spare parts

Workpiece
materials

Tip sizes, see page(s) 134
Edge preparation, see page(s) 131

Tolerances: Size:
L = ±0,05/0.002 06-09/2-3
L = ±0,08/0.003 12/4
S = ±0,13/0.005
RE = ±0,1/0.004

Please check availability at www.secotools.com/
Seco Online Store

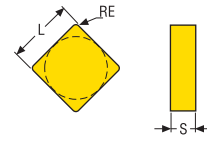

SNMN

SNMN



Designation	RE	L	S	EPRS°	AN°	Grades														
						Coated						Uncoated								
	mm Inch	mm Inch	mm Inch			CH0550	CBN060K	CH2540	CH3515	CBN300P	CK2065	CBN400C	CBN010	CBN150	CBN170	CBN200	CBN300	CBN500	CBN600	
SNMN060308E SNMN222E	0,8 0.031	6,35 0.250	3,18 0.125	90,0	-							■								
SNMN060308S SNMN222S	0,8 0.031	6,35 0.250	3,18 0.125	90,0	-												■			
SNMN090308E SNMN322E	0,8 0.031	9,525 0.375	3,18 0.125	90,0	-												■			
SNMN090312E SNMN323E	1,2 0.047	9,525 0.375	3,18 0.125	90,0	-												■			
SNMN090308S SNMN322S	0,8 0.031	9,525 0.375	3,18 0.125	90,0	-												■			
SNMN090308S-02020 SNMN322S-00820	0,8 0.031	9,525 0.375	3,18 0.125	90,0	-							■								
SNMN090312S SNMN323S	1,2 0.047	9,525 0.375	3,18 0.125	90,0	-					■							■			
SNMN090312S-02020P SNMN323S-00820P	1,2 0.047	9,525 0.375	3,18 0.125	90,0	-															■
SNMN090316S SNMN324S	1,6 0.063	9,525 0.375	3,18 0.125	90,0	-												■			
SNMN090308S-WZ SNMN322S-WZ	0,8 0.031	9,525 0.375	3,18 0.125	90,0	-												■			
SNMN090308S-WZ-85 SNMN322S-WZ-85	0,8 0.031	9,525 0.375	3,18 0.125	90,0	-												■			
SNMN090416S SNMN334S	1,6 0.063	9,525 0.375	4,76 0.187	90,0	-												■			
SNMN120312S SNMN423S	1,2 0.047	12,7 0.500	3,18 0.125	90,0	-												■			
SNMN120412S SNMN433S	1,2 0.047	12,7 0.500	4,76 0.187	90,0	-												■			
SNMN120412S-02020 SNMN433S-00820	1,2 0.047	12,7 0.500	4,76 0.187	90,0	-							■								
SNMN120416S SNMN434S	1,6 0.063	12,7 0.500	4,76 0.187	90,0	-												■			
SNMN120416S-02020 SNMN434S-00820	1,6 0.063	12,7 0.500	4,76 0.187	90,0	-														■	
SNMN120416S-02020P SNMN434S-00820P	1,6 0.063	12,7 0.500	4,76 0.187	90,0	-															■
SNMN120416S-04015 SNMN434S-01515	1,6 0.063	12,7 0.500	4,76 0.187	90,0	-												■			
SNMN120408S-02020-WZ85 SNMN432S-00820-WZ-85	0,8 0.031	12,7 0.500	4,76 0.187	90,0	-							■								■
SNMN120408S-WZ-85 SNMN432S-WZ-85	0,8 0.031	12,7 0.500	4,76 0.187	90,0	-												■			

General ISO Turning
Inserts

Steadyline®

MDT

Mini-Shaft™

Grooving

Parting-off

X4

Adapters
Clamping units

Accessories and
Spare parts

Workpiece
materials

TCGW

Tip sizes, see page(s) 134
Edge preparation, see page(s) 131

Tolerances:
IC = ±0,025/0,001
S = ±0,13/0,005
RE = ±0,1/0,004

Please check availability at www.secotools.com/
Seco Online Store

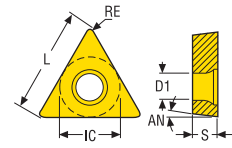

TCGW...-C

TCGW...-LF



Designation	RE	IC	L	S	W1	EPSR°	AN°	Grades														
								Coated						Uncoated								
	mm Inch	mm Inch	mm Inch	mm Inch	mm Inch			CH0550	CBN060K	CH2540	CH3515	CBN300P	CK2065	CBN400C	CBN010	CBN150	CBN170	CBN200	CBN300	CBN500	CBN600	
TCGW090204S-01020-LF TCGW1.81.51S-00420-LF	0,4 0.016	5,56 0.219	9,0 0.354	2,38 0.094	2,6 0.102	60,0	7,0								■			■				
TCGW110204E-L1-C TCGW21.51E-L1-C	0,4 0.016	6,35 0.250	11,0 0.433	2,38 0.094	2,9 0.114	60,0	7,0		■						■							
TCGW110208E-L1-C TCGW21.52E-L1-C	0,8 0.031	6,35 0.250	11,0 0.433	2,38 0.094	2,9 0.114	60,0	7,0								■							
TCGW110204S-01020-L1-C TCGW21.51S-00420-L1-C	0,4 0.016	6,35 0.250	11,0 0.433	2,38 0.094	2,9 0.114	60,0	7,0								■							
TCGW110204S-01525-L1-C TCGW21.51S-00625-L1-C	0,4 0.016	6,35 0.250	11,0 0.433	2,38 0.094	2,9 0.114	60,0	7,0		■													
TCGW110204S-02020-L1-C TCGW21.51S-00820-L1-C	0,4 0.016	6,35 0.250	11,0 0.433	2,38 0.094	2,9 0.114	60,0	7,0											■				
TCGW110208S-01020-L1-C TCGW21.52S-00420-L1-C	0,8 0.031	6,35 0.250	11,0 0.433	2,38 0.094	2,9 0.114	60,0	7,0								■							
TCGW110208S-01525-L1-C TCGW21.52S-00625-L1-C	0,8 0.031	6,35 0.250	11,0 0.433	2,38 0.094	2,9 0.114	60,0	7,0		■	■												
TCGW110208S-02020-L1-C TCGW21.52S-00820-L1-C	0,8 0.031	6,35 0.250	11,0 0.433	2,38 0.094	2,9 0.114	60,0	7,0											■				
TCGW110204S-01020-LF TCGW21.51S-00420-LF	0,4 0.016	6,35 0.250	11,0 0.433	2,38 0.094	2,9 0.114	60,0	7,0											■				
TCGW110208S-01020-LF TCGW21.52S-00420-LF	0,8 0.031	6,35 0.250	11,0 0.433	2,38 0.094	2,9 0.114	60,0	7,0											■				

General ISO Turning
Inserts

Steadyline®

MDT

Mini-Shaft™

Grooving

Parting-off

X4

Adapters
Clamping units

Accessories and
Spare parts

Workpiece
materials

TNGA

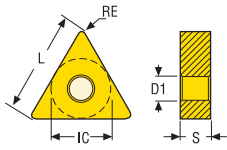

Tolerances:
IC = $\pm 0,025/0.001$
S = $\pm 0,13/0.005$
RE = $\pm 0,1/0.004$

Tip sizes, see page(s) 134
Edge preparation, see page(s) 131

Please check availability at www.secotools.com /
Seco Online Store

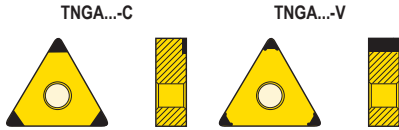

Designation	RE	IC	L	S	W1	EPSR°	AN°	Grades														
								Coated					Uncoated									
	mm Inch	mm Inch	mm Inch	mm Inch	mm Inch			CH0550	CBN060K	CH2540	CH3515	CBN300P	CK2065	CBN400C	CBN010	CBN150	CBN170	CBN200	CBN300	CBN500	CBN600	
TNGA160404S-01020-L1-C TNGA331S-00420-L1-C	0,4 0.016	9,525 0.375	16,5 0.650	4,76 0.187	3,81 0.150	60,0	-								■							
TNGA160408S-01020-L1-C TNGA332S-00420-L1-C	0,8 0.031	9,525 0.375	16,5 0.650	4,76 0.187	3,81 0.150	60,0	-								■							
TNGA160408S-01525-L1-C TNGA332S-00625-L1-C	0,8 0.031	9,525 0.375	16,5 0.650	4,76 0.187	3,81 0.150	60,0	-			■						■						
TNGA160408S-02020-L1-C TNGA332S-00820-L1-C	0,8 0.031	9,525 0.375	16,5 0.650	4,76 0.187	3,81 0.150	60,0	-											■				
TNGA160416S-00540-L1-C TNGA334S-00240-L1-C	1,6 0.063	9,525 0.375	16,5 0.650	4,76 0.187	3,81 0.150	60,0	-				■											
TNGA160420S-00540-L1-C TNGA335S-00240-L1-C	2,0 0.079	9,525 0.375	16,5 0.650	4,76 0.187	3,81 0.150	60,0	-				■											
TNGA160408S-01525-L1-V TNGA332S-00625-L1-V	0,8 0.031	9,525 0.375	16,5 0.650	4,76 0.187	3,81 0.150	60,0	-		■													

General ISO Turning
Inserts

Steadyline®

MDT

Mini-Shaft™

Grooving

Parting-off

X4

Adapters
Clamping units

Accessories and
Spare parts

Workpiece
materials

Tip sizes, see page(s) 134
Edge preparation, see page(s) 131

Tolerances:
IC = ±0,025/0.001
S = ±0,13/0.005
RE = ±0,1/0.004

Please check availability at www.secotools.com/
Seco Online Store

TNGN-LF

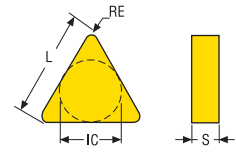

Designation	RE	IC	L	S	EPSR°	AN°	Grades														
							Coated					Uncoated									
	mm Inch	mm Inch	mm Inch	mm Inch			CH0550	CBN060K	CH2540	CH3515	CBN300P	CK2065	CBN400C	CBN010	CBN150	CBN170	CBN200	CBN300	CBN500	CBN600	
TNGN110312S-02020-LF	1,2	6,35	11,0	3,18																	
TNGN223S-00820-LF	0.047	0.250	0.433	0.125	60,0	-				■							■				

Tip sizes, see page(s) 134
Edge preparation, see page(s) 131

Tolerances:
IC = ±0,025/0.001
S = ±0,13/0.005
RE = ±0,1/0.004

Please check availability at www.secotools.com/
Seco Online Store

TNGN

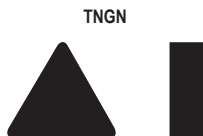
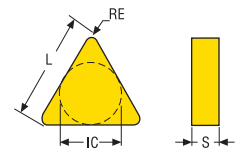

Designation	RE	IC	L	S	EPSR°	AN°	Grades														
							Coated					Uncoated									
	mm Inch	mm Inch	mm Inch	mm Inch			CH0550	CBN060K	CH2540	CH3515	CBN300P	CK2065	CBN400C	CBN010	CBN150	CBN170	CBN200	CBN300	CBN500	CBN600	
TNGN110308E25	0,8	6,35	11,0	3,18																	
TNGN222E25	0.031	0.250	0.433	0.125	60,0	-										■					
TNGN110304S-01020	0,4	6,35	11,0	3,18										■							
TNGN221S-00420	0.016	0.250	0.433	0.125	60,0	-															
TNGN110304S-01525	0,4	6,35	11,0	3,18			■	■													
TNGN221S-00625	0.016	0.250	0.433	0.125	60,0	-															
TNGN110308S-01020	0,8	6,35	11,0	3,18										■							
TNGN222S-00420	0.031	0.250	0.433	0.125	60,0	-															
TNGN110308S-01525	0,8	6,35	11,0	3,18			■	■	■						■						
TNGN222S-00625	0.031	0.250	0.433	0.125	60,0	-															
TNGN110312S-01020	1,2	6,35	11,0	3,18										■							
TNGN223S-00420	0.047	0.250	0.433	0.125	60,0	-															
TNGN110312S-01525	1,2	6,35	11,0	3,18			■	■	■						■						
TNGN223S-00625	0.047	0.250	0.433	0.125	60,0	-															
TNGN160304S-01020	0,4	9,525	16,5	3,18										■							
TNGN321S-00420	0.016	0.375	0.650	0.125	60,0	-															

General ISO Turning Inserts
Steadyline®
MDT
Mini-Shaft™
Grooving
Parting-off
X4
Adapters Clamping units
Accessories and Spare parts
Workpiece materials

TNGX

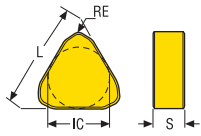

Tolerances:
IC = ±0,025/0.001
S = ±0,13/0.005
RE = ±0,1/0.004

Tip sizes, see page(s) 134
Edge preparation, see page(s) 131

Please check availability at www.secotools.com / Seco Online Store

TNGX...R/L-WZ
Crossbill™

TNGX...-WZ



Designation	RE	IC	L	S	EPSR°	AN°	Grades													
							Coated						Uncoated							
							CH0550	CBN060K	CH2540	CH3515	CBN300P	CK2065	CBN400C	CBN010	CBN150	CBN170	CBN200	CBN300	CBN500	CBN600
TNGX110308S-01020-WZ TNGX222S-00420-WZ	0,8 0.031	6,35 0.250	11,0 0.433	3,18 0.125	60,0	-							■							
TNGX110308S-01525-WZ TNGX222S-00625-WZ	0,8 0.031	6,35 0.250	11,0 0.433	3,18 0.125	60,0	-	■	■	■					■						
TNGX110308S-01020-R-WZ TNGX222S-00420-R-WZ	0,8 0.031	6,35 0.250	11,0 0.433	3,18 0.125	60,0	-		■					■							
TNGX110308S-01020-L-WZ TNGX222S-00420-L-WZ	0,8 0.031	6,35 0.250	11,0 0.433	3,18 0.125	60,0	-		■					■							

TNMN

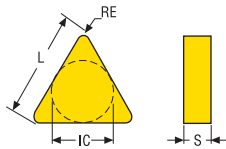

Tolerances:
IC = ±0,05/0.002
S = ±0,13/0.005
RE = ±0,1/0.004

Tip sizes, see page(s) 134
Edge preparation, see page(s) 131

Please check availability at www.secotools.com / Seco Online Store

TNMN



Designation	RE	IC	L	S	EPSR°	AN°	Grades														
							Coated						Uncoated								
							CH0550	CBN060K	CH2540	CH3515	CBN300P	CK2065	CBN400C	CBN010	CBN150	CBN170	CBN200	CBN300	CBN500	CBN600	
TNMN110308E TNMN222E	0,8 0.031	6,35 0.250	11,0 0.433	3,18 0.125	60,0	-														■	
TNMN110312E TNMN223E	1,2 0.047	6,35 0.250	11,0 0.433	3,18 0.125	60,0	-														■	
TNMN110304S TNMN221S	0,4 0.016	6,35 0.250	11,0 0.433	3,18 0.125	60,0	-														■	
TNMN110308S TNMN222S	0,8 0.031	6,35 0.250	11,0 0.433	3,18 0.125	60,0	-					■									■	
TNMN110312S TNMN223S	1,2 0.047	6,35 0.250	11,0 0.433	3,18 0.125	60,0	-														■	
TNMN160412S TNMN333S	1,2 0.047	9,525 0.375	16,5 0.650	4,76 0.187	60,0	-														■	

TNMX

Tip sizes, see page(s) 134
Edge preparation, see page(s) 131

Tolerances:
IC = $\pm 0,05/0.002$
S = $\pm 0,13/0.005$
RE = $\pm 0,1/0.004$

Please check availability at www.secotools.com/
Seco Online Store

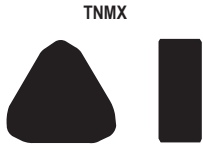
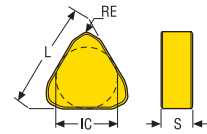

Designation	RE	IC	L	S	EPSR°	AN°	Grades														
							Coated					Uncoated									
	mm Inch	mm Inch	mm Inch	mm Inch			CH0550	CBN060K	CH2540	CH3515	CBN300P	CK2065	CBN400C	CBN010	CBN150	CBN170	CBN200	CBN300	CBN500	CBN600	
TNMX110308S-WZ	0,8	6,35	11,0	3,18	60,0	-															
TNMX222S-WZ	0.031	0.250	0.433	0.125																	

TPGN

Tip sizes, see page(s) 134
Edge preparation, see page(s) 131

Tolerances:
IC = $\pm 0,025/0.001$
S = $\pm 0,13/0.005$
RE = $\pm 0,1/0.004$

Please check availability at www.secotools.com/
Seco Online Store

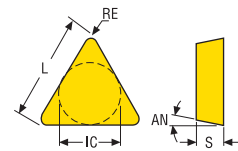

Designation	RE	IC	L	S	EPSR°	AN°	Grades														
							Coated					Uncoated									
	mm Inch	mm Inch	mm Inch	mm Inch			CH0550	CBN060K	CH2540	CH3515	CBN300P	CK2065	CBN400C	CBN010	CBN150	CBN170	CBN200	CBN300	CBN500	CBN600	
TPGN110308S-01020	0,8	6,35	11,0	3,18	60,0	11,0															
TPGN222S-00420	0.031	0.250	0.433	0.125																	

General ISO Turning
Inserts

Steadyline®

MDT

Mini-Shaft™

Grooving

Parting-off

X4

Adapters
Clamping units

Accessories and
Spare parts

Workpiece
materials

VBGW

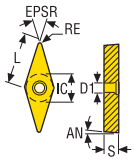

Tolerances:
IC = $\pm 0,025/0,001$
S = $\pm 0,13/0,005$
RE = $\pm 0,1/0,004$

Tip sizes, see page(s) 134
Edge preparation, see page(s) 131

Please check availability at www.secotools.com /
Seco Online Store

VBGW



VBGW...-B



Designation	RE	IC	L	S	W1	EPSR°	AN°	Grades														
								Coated						Uncoated								
	mm Inch	mm Inch	mm Inch	mm Inch	mm Inch			CH0550	CBN060K	CH2540	CH3515	CBN300P	CK2065	CBN400C	CBN010	CBN150	CBN170	CBN200	CBN300	CBN500	CBN600	
VBGW160408E-L1-B VBGW332E-L1-B	0,8 0.031	9,525 0.375	16,0 0.630	4,76 0.187	4,5 0.177	35,0	5,0		■													
VBGW160402S-01020-L1-B VBGW330.5S-00420-L1-B	0,2 0.008	9,525 0.375	16,0 0.630	4,76 0.187	4,5 0.177	35,0	5,0								■							
VBGW160402S-01525-L1-B VBGW330.5S-00625-L1-B	0,2 0.008	9,525 0.375	16,0 0.630	4,76 0.187	4,5 0.177	35,0	5,0			■												
VBGW160404S-01020-L1-B VBGW331S-00420-L1-B	0,4 0.016	9,525 0.375	16,0 0.630	4,76 0.187	4,5 0.177	35,0	5,0								■							
VBGW160404S-01525-L1-B VBGW331S-00625-L1-B	0,4 0.016	9,525 0.375	16,0 0.630	4,76 0.187	4,5 0.177	35,0	5,0	■	■	■						■						
VBGW160408S-01020-L1-B VBGW332S-00420-L1-B	0,8 0.031	9,525 0.375	16,0 0.630	4,76 0.187	4,5 0.177	35,0	5,0								■							
VBGW160408S-01525-L1-B VBGW332S-00625-L1-B	0,8 0.031	9,525 0.375	16,0 0.630	4,76 0.187	4,5 0.177	35,0	5,0		■	■						■						
VBGW160404S-02020-L2 VBGW331S-00820-L2	0,4 0.016	9,525 0.375	16,0 0.630	4,76 0.187	4,5 0.177	35,0	5,0								■							

General ISO Turning
Inserts

Steadyline®

MDT

Mini-Shaft™

Grooving

Parting-off

X4

Adapters
Clamping units

Accessories and
Spare parts

Workpiece
materials

VNGA

Tip sizes, see page(s) 134
Edge preparation, see page(s) 131

Tolerances:
IC = ±0,025/0.001
S = ±0,13/0.005
RE = ±0,1/0.004

Please check availability at www.secotools.com/
Seco Online Store

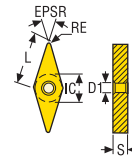

General ISO Turning
Inserts

Steadyline®

MDT

Mini-Shaft™

Grooving

Parting-off

X4

Adapters
Clamping units

Accessories and
Spare parts

Workpiece
materials

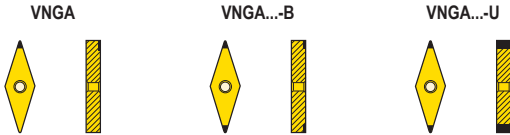

Designation	RE	IC	L	S	W1	EPSR°	AN°	Grades														
								Coated					Uncoated									
	mm Inch	mm Inch	mm Inch	mm Inch	mm Inch			CH0550	CBN060K	CH2540	CH3515	CBN300P	CK2065	CBN400C	CBN010	CBN150	CBN170	CBN200	CBN300	CBN500	CBN600	
VNGA160402S-01020-L1-B VNGA330.5S-00420-L1-B	0,2 0.008	9,525 0.375	16,0 0.630	4,76 0.187	3,81 0.150	35,0	-								■							
VNGA160402S-01525-L1-B VNGA330.5S-00625-L1-B	0,2 0.008	9,525 0.375	16,0 0.630	4,76 0.187	3,81 0.150	35,0	-			■												
VNGA160404S-01020-L1-B VNGA331S-00420-L1-B	0,4 0.016	9,525 0.375	16,0 0.630	4,76 0.187	3,81 0.150	35,0	-								■							
VNGA160404S-01525-L1-B VNGA331S-00625-L1-B	0,4 0.016	9,525 0.375	16,0 0.630	4,76 0.187	3,81 0.150	35,0	-			■						■						
VNGA160404S-02020-L1-B VNGA331S-00820-L1-B	0,4 0.016	9,525 0.375	16,0 0.630	4,76 0.187	3,81 0.150	35,0	-											■				
VNGA160408S-01020-L1-B VNGA332S-00420-L1-B	0,8 0.031	9,525 0.375	16,0 0.630	4,76 0.187	3,81 0.150	35,0	-								■							
VNGA160408S-01525-L1-B VNGA332S-00625-L1-B	0,8 0.031	9,525 0.375	16,0 0.630	4,76 0.187	3,81 0.150	35,0	-			■						■						
VNGA160408S-02020-L1-B VNGA332S-00820-L1-B	0,8 0.031	9,525 0.375	16,0 0.630	4,76 0.187	3,81 0.150	35,0	-				■							■				
VNGA160404S-01525-L1-U VNGA331S-00625-L1-U	0,4 0.016	9,525 0.375	16,0 0.630	4,76 0.187	3,81 0.150	35,0	-		■													
VNGA160408S-01525-L1-U VNGA332S-00625-L1-U	0,8 0.031	9,525 0.375	16,0 0.630	4,76 0.187	3,81 0.150	35,0	-		■													
VNGA160408S-02020-L2 VNGA332S-00820-L2	0,8 0.031	9,525 0.375	16,0 0.630	4,76 0.187	3,81 0.150	35,0	-								■							

Tip sizes, see page(s) 134
Edge preparation, see page(s) 131

Tolerances:
IC = ±0,05/0.002
S = ±0,13/0.005
RE = ±0,1/0.004

Please check availability at www.secotools.com/
Seco Online Store

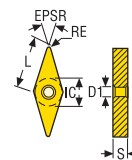

VNMA



Designation	RE	IC	L	S	W1	EPSR°	AN°	Grades														
								Coated					Uncoated									
	mm Inch	mm Inch	mm Inch	mm Inch	mm Inch			CH0550	CBN060K	CH2540	CH3515	CBN300P	CK2065	CBN400C	CBN010	CBN150	CBN170	CBN200	CBN300	CBN500	CBN600	
VNMA160416S VNMA334S	1,6 0.063	9,525 0.375	16,0 0.630	4,76 0.187	3,81 0.150	35,0	-												■			

WNGA

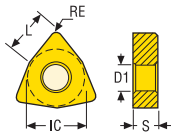

Tolerances:
IC = $\pm 0,025/0,001$
S = $\pm 0,13/0,005$
RE = $\pm 0,1/0,004$

Tip sizes, see page(s) 134
Edge preparation, see page(s) 131

Please check availability at www.secotools.com /
Seco Online Store

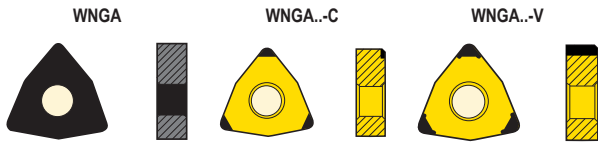

Designation	RE	IC	L	S	W1	EPSR°	AN°	Grades														
								Coated						Uncoated								
	mm <i>Inch</i>	mm <i>Inch</i>	mm <i>Inch</i>	mm <i>Inch</i>	mm <i>Inch</i>			CH0550	CBN060K	CH2540	CH3515	CBN300P	CK2065	CBN400C	CBN010	CBN150	CBN170	CBN200	CBN300	CBN500	CBN600	
WNGA060408S-01525-WZ	0,8	9,525	6,6	4,76	3,81	80,0	-		■													
WNGA332S-00625-WZ	0.031	0.375	0.260	0.187	0.150																	
WNGA060408S-02020-L1-C	0,8	9,525	6,6	4,76	3,81	80,0	-												■			
WNGA332S-00820-L1-C	0.031	0.375	0.260	0.187	0.150																	
WNGA080408S-01020-L1-C	0,8	12,7	8,7	4,76	5,15	80,0	-															
WNGA432S-00420-L1-C	0.031	0.500	0.343	0.187	0.203																	
WNGA080408S-01525-L1-C	0,8	12,7	8,7	4,76	5,15	80,0	-			■												
WNGA432S-00625-L1-C	0.031	0.500	0.343	0.187	0.203																	
WNGA080408S-01525-L1-V	0,8	12,7	8,7	4,76	5,15	80,0	-		■													
WNGA432S-00625-L1-V	0.031	0.500	0.343	0.187	0.203																	
WNGA080412S-01525-L1-V	1,2	12,7	8,7	4,76	5,15	80,0	-		■													
WNGA433S-00625-L1-V	0.047	0.500	0.343	0.187	0.203																	
WNGA080408S-01020-L1WZC	0,8	12,7	8,7	4,76	5,15	80,0	-															
WNGA432S-00420-L1-WZ-C	0.031	0.500	0.343	0.187	0.203																	
WNGA080408S-01525L1WZC	0,8	12,7	8,7	4,76	5,15	80,0	-			■												
WNGA432S-00625-L1-WZ-C	0.031	0.500	0.343	0.187	0.203																	
WNGA080412S-01525L1WZV	1,2	12,7	8,7	4,76	5,15	80,0	-		■													
WNGA433S-00625-L1-WZ-V	0.047	0.500	0.343	0.187	0.203																	

WNMA

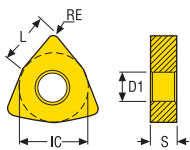

Tolerances:
IC = $\pm 0,08/0,003$
S = $\pm 0,13/0,005$
RE = $\pm 0,1/0,004$

Tip sizes, see page(s) 134
Edge preparation, see page(s) 131

Please check availability at www.secotools.com /
Seco Online Store

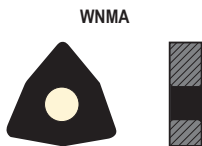

Designation	RE	IC	L	S	W1	EPSR°	AN°	Grades														
								Coated						Uncoated								
	mm <i>Inch</i>	mm <i>Inch</i>	mm <i>Inch</i>	mm <i>Inch</i>	mm <i>Inch</i>			CH0550	CBN060K	CH2540	CH3515	CBN300P	CK2065	CBN400C	CBN010	CBN150	CBN170	CBN200	CBN300	CBN500	CBN600	
WNMA060408S	0,8	9,52	6,6	4,76	3,81	80,0	-													■		
WNMA332S	0.031	0.375	0.260	0.187	0.150																	

CCGT

Tip sizes, see page(s) 134
Edge preparation, see page(s) 131

Tolerances:
IC = $\pm 0,025/0.001$
S = $\pm 0,13/0.005$
RE = $\pm 0,1/0.004$

Please check availability at www.secotools.com/
Seco Online Store

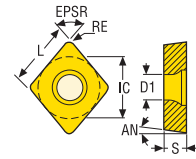

CCGT...-B

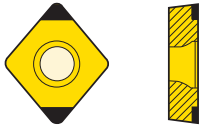

Designation	RE	IC	L	S	W1	EPSR°	AN°	Grades														
								Coated					Uncoated									
	mm Inch	mm Inch	mm Inch	mm Inch	mm Inch			CH0550	CBN060K	CH2540	CH3515	CBN300P	CK2065	CBN400C	CBN010	CBN150	CBN170	CBN200	CBN300	CBN500	CBN600	
CCGT09T304S-01525-L1-B CCGT32.51S-00625-L1-B	0,4 0.016	9,525 0.375	9,7 0.382	3,97 0.156	4,5 0.177	80,0	7,0		■													
CCGT09T304S-01525L1WZB CCGT32.51S-00625-L1-WZ-B	0,4 0.016	9,525 0.375	9,7 0.382	3,97 0.156	4,5 0.177	80,0	7,0		■													
CCGT09T304S-01525-L1WZB CCGT32.51S-00625-L1-WZ-B	0,4 0.016	9,525 0.375	9,7 0.382	3,97 0.156	4,5 0.177	80,0	7,0			■												

General ISO Turning
Inserts

Steadyline®

MDT

Mini-Shaft™

Grooving

Parting-off

X4

Adapters
Clamping units

Accessories and
Spare parts

Workpiece
materials

Tip sizes, see page(s) 134
Edge preparation, see page(s) 131

Tolerances:
IC = $\pm 0,025/0.001$
S = $\pm 0,13/0.005$
RE = $\pm 0,1/0.004$

Please check availability at www.secotools.com/
Seco Online Store

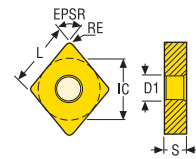

CNGM...-B



Designation	RE	IC	L	S	W1	EPSR°	AN°	Grades														
								Coated					Uncoated									
	mm Inch	mm Inch	mm Inch	mm Inch	mm Inch			CH0550	CBN060K	CH2540	CH3515	CBN300P	CK2065	CBN400C	CBN010	CBN150	CBN170	CBN200	CBN300	CBN500	CBN600	
CNGM120408S-01525-L1-B CNGM432S-00625-L1-B	0,8 0.031	12,7 0.500	12,9 0.508	4,76 0.187	5,15 0.203	80,0	0,0		■													
CNGM120408S-07525-L1-B CNGM432S-03025-L1-B	0,8 0.031	12,7 0.500	12,9 0.508	4,76 0.187	5,15 0.203	80,0	0,0			■												
CNGM120412S-07525-L1-B CNGM433S-03025-L1-B	1,2 0.047	12,7 0.500	12,9 0.508	4,76 0.187	5,15 0.203	80,0	0,0			■												
CNGM120408S-01525L1WZB CNGM432S-00625-L1-WZ-B	0,8 0.031	12,7 0.500	12,9 0.508	4,76 0.187	5,15 0.203	80,0	0,0		■													
CNGM120408S-07525-L1WZB CNGM432S-03025-L1WZB	0,8 0.031	12,7 0.500	12,9 0.508	4,76 0.187	5,15 0.203	80,0	0,0			■												

CNGM

X4

Adapters
Clamping units

Accessories and
Spare parts

Workpiece
materials

DNGM

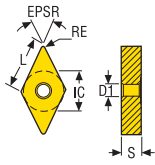

Tolerances:
IC = $\pm 0,025/0,001$
S = $\pm 0,13/0,005$
RE = $\pm 0,1/0,004$

Tip sizes, see page(s) 134
Edge preparation, see page(s) 131

Please check availability at www.secotools.com /
Seco Online Store

DNGM...-B



Designation	RE	IC	L	S	W1	EPSR°	AN°	Grades														
								Coated						Uncoated								
	mm Inch	mm Inch	mm Inch	mm Inch	mm Inch			CH0550	CBN060K	CH2540	CH3515	CBN300P	CK2065	CBN400C	CBN010	CBN150	CBN170	CBN200	CBN300	CBN500	CBN600	
DNGM150408S-07525-L1-B DNGM432S-03025-L1-B	0,8 0.031	12,7 0.500	15,5 0.610	4,76 0.187	5,15 0.203	55,0	-			■												
DNGM150412S-07525-L1-B DNGM433S-03025-L1-B	1,2 0.047	12,7 0.500	15,5 0.610	4,76 0.187	5,15 0.203	55,0	-			■												
DNGM150408S-07525-L1WZB DNGM432S-03025-L1WZB	0,8 0.031	12,7 0.500	15,5 0.610	4,76 0.187	5,15 0.203	55,0	-			■												

General ISO Turning
Inserts

Steadyline®

MDT

Mini-Shaft™

Grooving

Parting-off

X4

Adapters
Clamping units

Accessories and
Spare parts

Workpiece
materials

CCMW

Tip sizes, see page(s) 134
Edge preparation, see page(s) 131

Tolerances: Size:
IC = ±0,05/0.002 06-09/2-3
IC = ±0,08/0.003 12/4
S = ±0,13/0.005
RE = ±0,05/0.002

Please check availability at www.secotools.com/
Seco Online Store

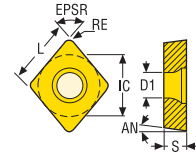

CCMW

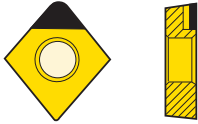

Designation	RE	IC	L	S	W1	EPSR°	AN°	Grades		
								Uncoated		
	mm Inch	mm Inch	mm Inch	mm Inch	mm Inch			PCD20	PCD30	PCD30M
CCMW060202F-L1 CCMW21.50.5F-L1	0,2 0.008	6,35 0.250	6,5 0.256	2,38 0.094	2,9 0.114	80,0	7,0	■		
CCMW060204F-L1 CCMW21.51F-L1	0,4 0.016	6,35 0.250	6,5 0.256	2,38 0.094	2,9 0.114	80,0	7,0	■	■	
CCMW060208F-L1 CCMW21.52F-L1	0,8 0.031	6,35 0.250	6,5 0.256	2,38 0.094	2,9 0.114	80,0	7,0	■		
CCMW060208F-L1-WZ CCMW21.52F-L1-WZ	0,8 0.031	6,35 0.250	6,5 0.256	2,38 0.094	2,9 0.114	80,0	7,0	■		
CCMW09T302F-L1 CCMW32.50.5F-L1	0,2 0.008	9,52 0.375	9,7 0.382	3,97 0.156	4,5 0.177	80,0	7,0	■		
CCMW09T304F-L1 CCMW32.51F-L1	0,4 0.016	9,52 0.375	9,7 0.382	3,97 0.156	4,5 0.177	80,0	7,0	■		
CCMW09T308F-L1 CCMW32.52F-L1	0,8 0.031	9,52 0.375	9,7 0.382	3,97 0.156	4,5 0.177	80,0	7,0	■		
CCMW120404F-L1 CCMW431F-L1	0,4 0.016	12,7 0.500	12,9 0.508	4,76 0.187	5,6 0.220	80,0	7,0	■		
CCMW120408F-L1 CCMW432F-L1	0,8 0.031	12,7 0.500	12,9 0.508	4,76 0.187	5,6 0.220	80,0	7,0	■		

General ISO Turning
Inserts

Steadyline®

MDT

Mini-Shaft™

Grooving

Parting-off

X4

Adapters
Clamping units

Accessories and
Spare parts

Workpiece
materials

DCMW

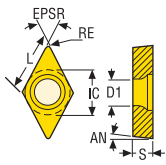

Tolerances:
IC = $\pm 0,05/0,002$
S = $\pm 0,13/0,005$
RE = $\pm 0,05/0,002$

Tip sizes, see page(s) 134
Edge preparation, see page(s) 131

Please check availability at www.secotools.com /
Seco Online Store

DCMW

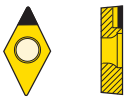

Designation	RE	IC	L	S	W1	EPSR°	AN°	Grades		
								Uncoated		
	mm <i>Inch</i>	mm <i>Inch</i>	mm <i>Inch</i>	mm <i>Inch</i>	mm <i>Inch</i>			PCD20	PCD30	PCD30M
DCMW070202F-L1 DCMW21.50.5F-L1	0,2 0.008	6,35 0.250	7,8 0.307	2,38 0.094	2,9 0.114	55,0	7,0	■		
DCMW070204F-L1 DCMW21.51F-L1	0,4 0.016	6,35 0.250	7,8 0.307	2,38 0.094	2,9 0.114	55,0	7,0	■		
DCMW11T302F-L1 DCMW32.50.5F-L1	0,2 0.008	9,52 0.375	11,6 0.457	3,97 0.156	4,5 0.177	55,0	7,0	■		
DCMW11T304F-L1 DCMW32.51F-L1	0,4 0.016	9,52 0.375	11,6 0.457	3,97 0.156	4,5 0.177	55,0	7,0	■		

RCGN

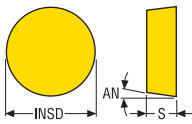

Tolerances:
INSD = $\pm 0,025/0,001$
S = $\pm 0,13/0,005$

Tip sizes, see page(s) 134
Edge preparation, see page(s) 131

Please check availability at www.secotools.com /
Seco Online Store

RCGN



Designation	INSD	S	EPSR°	AN°	Grades		
					Uncoated		
	mm <i>Inch</i>	mm <i>Inch</i>			PCD20	PCD30	PCD30M
RCGN090300F-LF RCGN32F-LF	9,52 0.375	3,18 0.125	-	7,0	■		

General ISO Turning
Inserts

Steadyline®

MDT

Mini-Shaft™

Grooving

Parting-off

X4

Adapters
Clamping units

Accessories and
Spare parts

Workpiece
materials

Tip sizes, see page(s) 134
Edge preparation, see page(s) 131

Tolerances:
INSD = $\pm 0,025/0,001$
S = $\pm 0,13/0,005$

Please check availability at www.secotools.com /
Seco Online Store

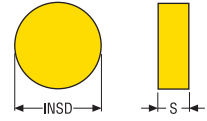

RNGN

General ISO Turning
Inserts

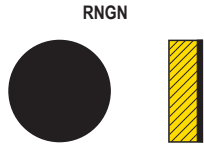

Designation	INSD	S	EPSR°	AN°	Grades		
					Uncoated		
	mm Inch	mm Inch			PCD20	PCD30	PCD30M
RNGN060300F-LF RNGN22F-LF	6,35 0.250	3,18 0.125	-	-			■
RNGN090300F-LF RNGN32F-LF	9,52 0.375	3,18 0.125	-	-	■	■	
RNGN120300F-LF RNGN42F-LF	12,7 0.500	3,18 0.125	-	-	■		

Tip sizes, see page(s) 134
Edge preparation, see page(s) 131

Tolerances:
IC = $\pm 0,05/0,002$
S = $\pm 0,13/0,005$
RE = $\pm 0,05/0,002$

Please check availability at www.secotools.com /
Seco Online Store

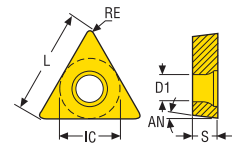

TCMW

Grooving

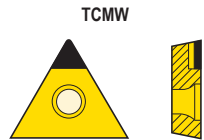

Designation	RE	IC	L	S	W1	EPSR°	AN°	Grades		
								Uncoated		
	mm Inch	mm Inch	mm Inch	mm Inch	mm Inch			PCD20	PCD30	PCD30M
TCMW110204F-L1 TCMW21.51F-L1	0,4 0.016	6,35 0.250	11,0 0.433	2,38 0.094	2,9 0.114	60,0	7,0	■		
TCMW16T304F-L1 TCMW32.51F-L1	0,4 0.016	9,52 0.375	16,5 0.650	3,97 0.156	4,5 0.177	60,0	7,0	■		

Parting-off

X4

Adapters
Clamping units

Accessories and
Spare parts

Workpiece
materials

TPGN

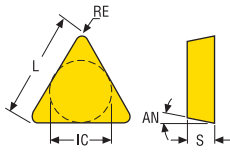

Tolerances:
IC = $\pm 0,025/0.001$
S = $\pm 0,13/0.005$
RE = $\pm 0,05/0.002$

Tip sizes, see page(s) 134
Edge preparation, see page(s) 131

Please check availability at www.secotools.com /
Seco Online Store

TPGN



Designation	RE	IC	L	S	EPSR°	AN°	Grades		
							Uncoated		
	mm Inch	mm Inch	mm Inch	mm Inch			PCD20	PCD30	PCD30M
TPGN160302F-L1 TPGN320.5F-L1	0,2 0.008	9,525 0.375	16,5 0.650	3,18 0.125	60,0	11,0	■		
TPGN160304F-L1 TPGN321F-L1	0,4 0.016	9,525 0.375	16,5 0.650	3,18 0.125	60,0	11,0	■		
TPGN160308F-L1 TPGN322F-L1	0,8 0.031	9,525 0.375	16,5 0.650	3,18 0.125	60,0	11,0	■		

VBMW

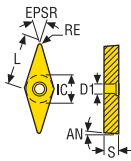

Tolerances:
IC = $\pm 0,05/0.002$
S = $\pm 0,13/0.005$
RE = $\pm 0,05/0.002$

Tip sizes, see page(s) 134
Edge preparation, see page(s) 131

Please check availability at www.secotools.com /
Seco Online Store

VBMW

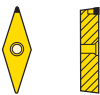

Designation	RE	IC	L	S	W1	EPSR°	AN°	Grades		
								Uncoated		
	mm Inch	mm Inch	mm Inch	mm Inch	mm Inch			PCD20	PCD30	PCD30M
VBMW160402F-L1 VBMW330.5F-L1	0,2 0.008	9,52 0.375	16,0 0.630	4,76 0.187	4,5 0.177	35,0	5,0	■		
VBMW160404F-L1 VBMW331F-L1	0,4 0.016	9,52 0.375	16,0 0.630	4,76 0.187	4,5 0.177	35,0	5,0	■		

CNGN

Edge preparation, see page(s) 131

Please check availability at www.secotools.com /
Seco Online Store

Tolerances:
IC = $\pm 0,025/0.001$
S = $\pm 0,13/0.005$
RE = $\pm 0,1/0.004$

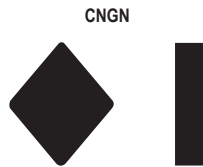
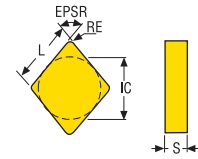

Designation	RE	IC	L	S	EPSR°	AN°	Grades Uncoated		
							CS100	CS300	CW100
CNGN120408S-01020 CNGN432S-00420	0,8 0.031	12,7 0.500	12,9 0.508	4,76 0.187	80,0	-	■		
CNGN120708S-01020 CNGN452S-00420	0,8 0.031	12,7 0.500	12,9 0.508	7,94 0.313	80,0	-	■		
CNGN120712S-01020 CNGN453S-00420	1,2 0.047	12,7 0.500	12,9 0.508	7,94 0.313	80,0	-	■		

Edge preparation, see page(s) 131

Please check availability at www.secotools.com /
Seco Online Store

Tolerances:
INSD = $\pm 0,025/0.001$
S = $\pm 0,13/0.005$

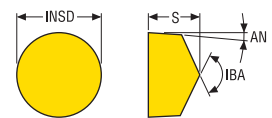

Designation	INSD	S	EPSR°	AN°	Grades Uncoated		
					CS100	CS300	CW100
RCGX060600E RCGX240E	6,35 0.250	6,35 0.250	-	-			■
RCGX060600T-01020 RCGX24T-00420	6,35 0.250	6,35 0.250	-	7,0	■		■
RCGX090700E RCGX350E	9,525 0.375	7,94 0.313	-	-			■
RCGX090700T-01020 RCGX35T-00420	9,525 0.375	7,94 0.313	-	7,0	■		■
RCGX120700E RCGX450E	12,7 0.500	7,94 0.313	-	-			■
RCGX120700S-01020 RCGX45S-00420	12,7 0.500	7,94 0.313	-	7,0	■		■
RCGX120700T-01020 RCGX450T-00420	12,7 0.500	7,94 0.313	-	7,0	■		■

General ISO Turning Inserts

Steadyline®

MDT

Mini-Shaft™

Grooving

Parting-off

X4

Adapters Clamping units

Accessories and Spare parts

Workpiece materials

RNGN

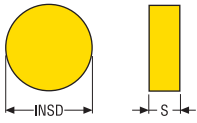

Tolerances:
INSD = $\pm 0,025/0.001$
S = $\pm 0,13/0.005$

Edge preparation, see page(s) 131

Please check availability at www.secotools.com / Seco Online Store

General ISO Turning
Inserts

Steadyline®



MDT

Designation	INSD	S	EPSR°	AN°	Grades		
					Uncoated		
	mm Inch	mm Inch			CS100	CS300	CW100
RNGN120400S-01020 RNGN43S-00420	12,7 0.500	4,76 0.187	-	-	■		
RNGN120400T-01020 RNGN43T-00420	12,7 0.500	4,76 0.187	-	-	■	■	
RNGN120700E RNGN450E	12,7 0.500	7,94 0.313	-	-			■
RNGN120700S-01020 RNGN45S-00420	12,7 0.500	7,94 0.313	-	-	■		
RNGN120700T-01020 RNGN45T-00420	12,7 0.500	7,94 0.313	-	-	■	■	■

Mini-Shaft™

Grooving

RPGN

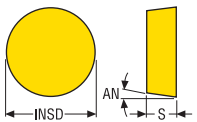

Tolerances:
INSD = $\pm 0,025/0.001$
S = $\pm 0,13/0.005$

Edge preparation, see page(s) 131

Please check availability at www.secotools.com / Seco Online Store

Parting-off

X4



Adapters
Clamping units

Designation	INSD	S	EPSR°	AN°	Grades		
					Uncoated		
	mm Inch	mm Inch			CS100	CS300	CW100
RPGN120400T-01020 RPGN43T-00420	12,7 0.500	4,76 0.187	-	-		■	

Accessories and
Spare parts

Workpiece
materials

Edge preparation, see page(s) 131

Please check availability at www.secotools.com /
Seco Online Store

Tolerances:
INSD = $\pm 0,025/0,001$
S = $\pm 0,13/0,005$

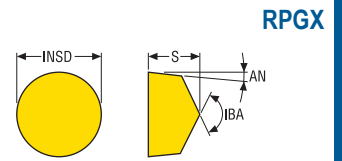

Designation	INSD	S	EPSR°	AN°	Grades Uncoated		
					CS100	CS300	CW100
RPGX090700T-01020 RPGX35T-00420	9,525 0.375	7,94 0.313	-	11,0	■		
RPGX120700S-01020 RPGX45S-00420	12,7 0.500	7,94 0.313	-	11,0	■		
RPGX120700T-01020 RPGX45T-00420	12,7 0.500	7,94 0.313	-	11,0	■		

- General ISO Turning Inserts
- Steadyline®
- MDT
- Mini-Shaft™
- Grooving
- Parting-off
- X4
- Adapters
Clamping units
- Accessories and
Spare parts
- Workpiece
materials



General ISO Turning

Steadyline®

MDT

Mini-Shaft™

Grooving

Parting-off

X4

Adapters
Clamping units

Accessories and
Spare parts

Workpiece
materials

Vibration-damping solutions

Steadyline®

Steadyline® is a modular anti-vibration tooling system consisting of dampened bars, providing an easily exchangeable head with the accurate and reliable GL interface. To add applicability, the bars are highly capable both for problem-free long-overhang internal turning as well as rotating boring applications.

- Body diameters $\varnothing 25$, $\varnothing 32$, $\varnothing 40$, $\varnothing 50$, $\varnothing 60$, $\varnothing 80$ & $\varnothing 100$ mm / $\varnothing 0.984$, $\varnothing 1.260$, $\varnothing 1.575$, $\varnothing 1.969$, $\varnothing 2.362$, $\varnothing 3.150$ & $\varnothing 3.937$ inch.
- Lengths 6xD, 8xD and 10xD.
- Seco-Capto™ C4, C5, C6, C8 connections, HSK-T/A 63, HSK-T/A 100.
- Cylindrical shanks-Both in Metric & Inch Sizes.

Modular GL-heads

Modular GL-heads for Steadyline® anti-vibration tooling are easily exchangeable toolholder heads with the accurate and reliable GL interface. GL turning heads are offered for problem-free long-overhang internal turning accommodating a comprehensive range of insert types, shapes and sizes for respective bar diameters.

GL – Steadyline®, HSK-T/A GL holders, body diameters 25, 32, 40 and 50 mm / 0.984, 1.260, 1.575 and 1.969 inch – Metric/ Inch

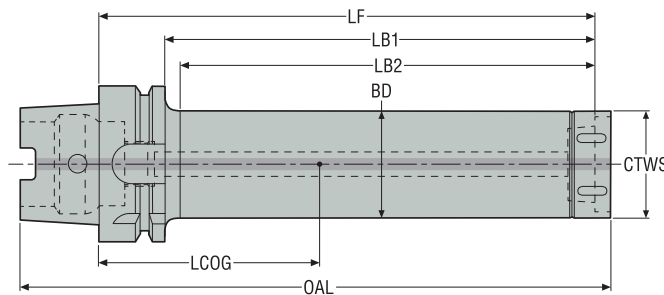

- With dynamic damping, ready to use
- With through coolant
- For GL heads program, see page(s) 621-659
- * Max. RPM only when used in rotating boring
- Please check availability at www.secotools.com / Seco Online Store

Designation	Item number	CTMS HSK-T/A	CTWS GL size	BD	LF	LB1	LB2	OAL	LCOG	Max. RPM*	RFID hole	Balancing	Weight
				mm Inch	mm Inch	mm Inch	mm Inch	mm Inch	mm Inch				kg lbs
HSKTA63-GL25-130-K	03214283	HSK-T/A63	GL25	25,0 0.984	130,0 5.118	104,0 4.094	101,0 3.976	166,5 6.555	37,0 1.457	10000	1	PB	1,1 2.430
HSKTA63-GL25-180-K	03214284	HSK-T/A63	GL25	25,0 0.984	180,0 7.087	154,0 6.063	151,0 5.945	216,5 8.524	57,7 2.272	8000	1	PB	1,3 2.870
HSKTA63-GL25-230-K	03214285	HSK-T/A63	GL25	25,0 0.984	230,0 9.055	204,0 8.031	201,0 7.913	266,5 10.492	80,3 3.161	6000	1	PB	1,5 3.310
E9374-D32-160-GL32	03029521	HSK-T/A63	GL32	32,0 1.260	160,0 6.299	134,0 5.276	128,0 5.039	197,4 7.772	58,92 2.320	10000	1	PB	1,6 3.530
E9374-D32-224-GL32	03029522	HSK-T/A63	GL32	32,0 1.260	224,0 8.819	198,0 7.795	192,0 7.559	261,4 10.291	90,22 3.552	8000	1	PB	2,0 4.410
E9374-D40-208-GL40	03029523	HSK-T/A63	GL40	40,0 1.575	208,0 8.189	182,0 7.165	176,0 6.929	246,4 9.701	92,78 3.653	8000	1	PB	2,7 5.950
E9374-D40-288-GL40	03029524	HSK-T/A63	GL40	40,0 1.575	288,0 11.339	262,0 10.315	256,0 10.079	326,4 12.850	134,37 5.290	6000	1	PB	3,5 7.720
E9374-D50-268-GL50	03029525	HSK-T/A63	GL50	50,0 1.969	268,0 10.551	242,0 9.528	240,5 9.469	307,4 12.102	131,8 5.189	6000	1	PB	4,8 10.580
E9374-D50-368-GL50	03029526	HSK-T/A63	GL50	50,0 1.969	368,0 14.488	342,0 13.465	340,5 13.406	407,4 16.039	184,79 7.275	4000	1	PB	6,4 14.110
E9376-D32-160-GL32	03029527	HSK-T/A100	GL32	32,0 1.260	160,0 6.299	131,0 5.157	125,0 4.921	215,4 8.480	32,87 1.294	10000	1	PB	3,0 6.610
E9376-D32-224-GL32	03029528	HSK-T/A100	GL32	32,0 1.260	224,0 8.819	195,0 7.677	189,0 7.441	279,4 11.000	54,97 2.164	8000	1	PB	3,4 7.500
E9376-D32-288-GL32	03029529	HSK-T/A100	GL32	32,0 1.260	288,0 11.339	259,0 10.197	253,0 9.961	343,4 13.520	80,51 3.170	6000	1	PB	3,8 8.380
E9376-D40-208-GL40	03029530	HSK-T/A100	GL40	40,0 1.575	208,0 8.189	179,0 7.047	173,0 6.811	264,4 10.409	62,83 2.474	8000	1	PB	4,1 9.040
E9376-D40-288-GL40	03029531	HSK-T/A100	GL40	40,0 1.575	288,0 11.339	259,0 10.197	253,0 9.961	344,4 13.559	98,31 3.870	6000	1	PB	4,9 10.800
E9376-D40-368-GL40	03029532	HSK-T/A100	GL40	40,0 1.575	368,0 14.488	339,0 13.346	333,0 13.110	424,4 16.709	139,77 5.503	5000	1	PB	5,8 12.790
E9376-D50-268-GL50	03029533	HSK-T/A100	GL50	50,0 1.969	268,0 10.551	239,0 9.409	234,0 9.213	325,4 12.811	104,26 4.105	6000	1	PB	6,2 13.670
E9376-D50-368-GL50	03029534	HSK-T/A100	GL50	50,0 1.969	368,0 14.488	339,0 13.346	334,0 13.150	425,4 16.748	154,26 6.073	4000	1	PB	7,8 17.200
E9376-D50-468-GL50	03029535	HSK-T/A100	GL50	50,0 1.969	468,0 18.425	439,0 17.283	434,0 17.087	525,4 20.685	211,61 8.331	2500	1	PB	9,7 21.380

General ISO Turning

Steadyline®

MDT

Mini-Shaft™

Grooving

Parting-off

X4

Adapters
Clamping units

Accessories and
Spare parts

Workpiece
materials

Spare Parts

General ISO Turning

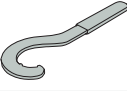
For size	Locking key
GL25	SL25 
GL32	SL32
GL40	SL40
GL50	SL50

Steadyline®

Accessories

MDT

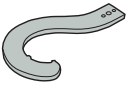
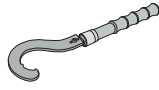
For size	Replaceable end 	Torque key 
GL25	-	-
GL32	SL00-32	SL00-32.250
GL40	SL00-40	SL00-40.350
GL50	SL00-50	SL00-50.550

Mini-Shaft™

Grooving

Parting-off

X4

Adapters
Clamping units

Accessories and
Spare parts

Workpiece
materials

BA – Steadyline®, HSK T/A-BA holders, body diameters 60 and 80 mm / 2.362 and 3.150 inch – Metric / Inch

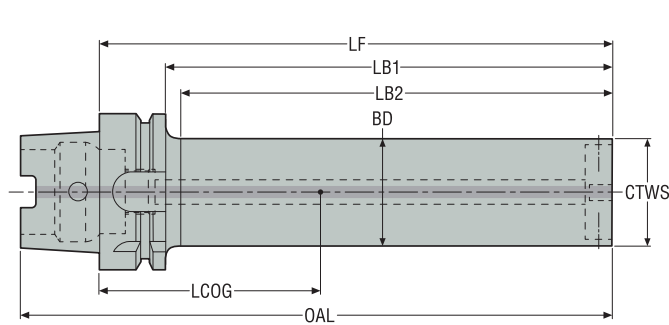

- With dynamic damping, ready to use
- To hold BA to GL adapters with GL turning heads
- With through coolant
- For BA-to-GL adapters program, see page 619
- For GL heads program, see page(s) 621-659
- * Max. RPM only when used in rotating boring
- Please check availability at www.secotools.com / Seco Online Store

Designation	Item number	CTMS HSK-T/A size	CTWS BA connection	BD	LF	LB1	LB2	OAL	LCOG	Max. RPM*	RFID hole	Balancing	Weight
				mm Inch	mm Inch	mm Inch	mm Inch	mm Inch	mm Inch				kg lbs
E9376-D60-301-BA060	03062828	HSK-T/A100	BA060	60,0 2.362	301,0 11.850	272,0 10.709	267,0 10.512	351,0 13.819	133,05 5.238	4000	1	PB	8,9 19.620
E9376-D60-421-BA060	03062829	HSK-T/A100	BA060	60,0 2.362	421,0 16.575	392,0 15.433	387,0 15.236	471,0 18.543	197,17 7.763	3000	1	PB	11,8 26.010
E9376-D60-541-BA060	03062830	HSK-T/A100	BA060	60,0 2.362	541,0 21.299	512,0 20.157	507,0 19.961	591,0 23.268	260,56 10.258	2000	1	PB	14,5 31.970
E9376-D80-421-BA080	03064109	HSK-T/A100	BA080	80,0 3.150	421,0 16.575	392,0 15.433	387,0 15.236	471,0 18.543	209,68 8.255	3000	1	PB	19,4 42.770
E9376-D80-581-BA080	03064111	HSK-T/A100	BA080	80,0 3.150	581,0 22.874	552,0 21.732	547,0 21.535	631,0 24.843	295,45 11.632	2000	1	PB	26,2 57.760

Spare Parts

For size	Locking screw
BA060	90FQ4
BA080	90FQ52

Accessories

For size	Locking key
BA060	03H04
BA080	03H05

General / ISO Turning

Steadyline®

MDT

Mini-Shaft™

Grooving

Parting-off

X4

Adapters
Clamping units

Accessories and
Spare parts

Workpiece
materials

General ISO Turning

GL – Steadyline®, GL holders, body diameters 25, 32, 40 and 50 mm / 0.984, 1.260, 1.575 and 1.969 inch – Metric/ Inch

Steadyline®

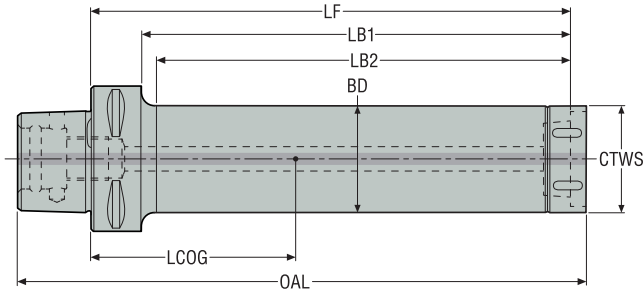

MDT

- With dynamic damping, ready to use
- With through coolant
- For GL heads program, see page(s) 621-659
- * Max. RPM only when used in rotating boring
- Please check availability at www.secotools.com / Seco Online Store

Mini-Shaft™

Designation	Item number	CTMS Seco-Capto™ size	CTWS GL size	BD	LF	LB1	LB2	OAL	LCOG	Max. RPM*	RFID hole	Balancing	Weight
				mm Inch	mm Inch	mm Inch	mm Inch	mm Inch	mm Inch				kg lbs
C4-D25-130-GL25	03214272	C4	GL25	25,0 0.984	130,0 5.118	110,0 4.331	107,0 4.213	158,5 6.240	51,8 2.039	10000	0	PB	0,8 1.760
C4-D25-180-GL25	03214273	C4	GL25	25,0 0.984	180,0 7.087	160,0 6.299	157,0 6.181	208,5 8.209	77,2 3.039	8000	0	PB	1,0 2.200
C4-D32-160-GL32	02807837	C4	GL32	32,0 1.260	160,0 6.299	140,0 5.512	137,0 5.394	189,4 7.457	74,73 2.942	10000	0	PB	1,2 2.650
C4-D32-224-GL32	02807838	C4	GL32	32,0 1.260	224,0 8.819	204,0 8.031	201,0 7.913	253,4 9.976	109,16 4.298	8000	0	PB	1,7 3.750
C5-D25-130-GL25	03214274	C5	GL25	25,0 0.984	130,0 5.118	110,0 4.331	107,0 4.213	164,5 6.476	41,8 1.646	10000	1	PB	0,9 1.980
C5-D25-180-GL25	03214275	C5	GL25	25,0 0.984	180,0 7.087	160,0 6.299	157,0 6.181	214,5 8.445	65,1 2.563	8000	1	PB	1,1 2.430
C5-D25-230-GL25	03214276	C5	GL25	25,0 0.984	230,0 9.055	210,0 8.268	207,0 8.150	264,5 10.413	89,8 3.535	6000	1	PB	1,3 2.870
C5-D32-160-GL32	02807840	C5	GL32	32,0 1.260	160,0 6.299	140,0 5.512	136,0 5.354	195,4 7.693	65,15 2.565	10000	1	PB	1,4 3.090
C5-D32-224-GL32	02807841	C5	GL32	32,0 1.260	224,0 8.819	204,0 8.031	200,0 7.874	259,4 10.213	98,47 3.877	8000	1	PB	1,8 3.970
C5-D32-288-GL32	02807842	C5	GL32	32,0 1.260	288,0 11.339	268,0 10.551	264,0 10.394	323,4 12.732	133,61 5.260	6000	1	PB	2,2 4.850
C5-D40-208-GL40	02807843	C5	GL40	40,0 1.575	208,0 8.189	188,0 7.402	184,0 7.244	244,4 9.622	98,32 3.871	8000	1	PB	2,5 5.510
C5-D40-288-GL40	02807844	C5	GL40	40,0 1.575	288,0 11.339	268,0 10.551	264,0 10.394	324,4 12.772	140,88 5.546	6000	1	PB	3,3 7.280
C5-D40-368-GL40	02807845	C5	GL40	40,0 1.575	368,0 14.488	348,0 13.701	344,0 13.543	404,4 15.921	187,43 7.379	5000	1	PB	4,3 9.480
C6-D25-130-GL25	03214277	C6	GL25	25,0 0.984	130,0 5.118	105,0 4.134	102,0 4.016	172,5 6.791	30,4 1.197	10000	1	PB	1,3 2.870
C6-D25-180-GL25	03214278	C6	GL25	25,0 0.984	180,0 7.087	155,0 6.102	152,0 5.984	222,5 8.760	49,3 1.941	8000	1	PB	1,5 3.310
C6-D25-230-GL25	03214279	C6	GL25	25,0 0.984	230,0 9.055	205,0 8.071	202,0 7.953	272,5 10.728	70,2 2.764	6000	1	PB	1,7 3.750
C6-D32-160-GL32	02807846	C6	GL32	32,0 1.260	160,0 6.299	135,0 5.315	129,0 5.079	203,4 8.008	52,06 2.050	10000	1	PB	1,8 3.970
C6-D32-224-GL32	02807847	C6	GL32	32,0 1.260	224,0 8.819	199,0 7.835	193,0 7.598	267,4 10.528	82,17 3.235	8000	1	PB	2,2 4.850
C6-D32-288-GL32	02807848	C6	GL32	32,0 1.260	288,0 11.339	263,0 10.354	257,0 10.118	331,4 13.047	114,87 4.522	6000	1	PB	2,6 5.730

Designation	Item number	CTMS Seco-Capto™ size	CTWS GL size	BD	LF	LB1	LB2	OAL	LCOG	Max. RPM*	RFID hole	Balancing	Weight
				mm Inch	mm Inch	mm Inch	mm Inch	mm Inch	mm Inch				
C6-D40-208-GL40	02807849	C6	GL40	40,0 1.575	208,0 8.189	183,0 7.205	177,0 6.969	252,4 9.937	86,42 3.402	8000	1	PB	2,9 6.390
C6-D40-288-GL40	02807850	C6	GL40	40,0 1.575	288,0 11.339	263,0 10.354	257,0 10.118	332,4 13.087	127,5 5.020	6000	1	PB	3,7 8.160
C6-D40-368-GL40	02807851	C6	GL40	40,0 1.575	368,0 14.488	343,0 13.504	337,0 13.268	412,4 16.236	173,14 6.817	5000	1	PB	4,6 10.140
C6-D50-268-GL50	02807852	C6	GL50	50,0 1.969	268,0 10.551	243,0 9.567	238,0 9.370	313,4 12.339	126,6 4.984	6000	1	PB	5,0 11.020
C6-D50-368-GL50	02807853	C6	GL50	50,0 1.969	368,0 14.488	343,0 13.504	338,0 13.307	413,4 16.276	179,44 7.065	4000	1	PB	6,6 14.550
C6-D50-468-GL50	02807854	C6	GL50	50,0 1.969	468,0 18.425	443,0 17.441	438,0 17.244	513,4 20.213	238,49 9.389	2500	1	PB	8,5 18.740
C8-D32-224-GL32	03029356	C8	GL32	32,0 1.260	224,0 8.819	191,0 7.520	181,0 7.126	277,5 10.925	58,17 2.290	8000	1	PB	3,2 7.050
C8-D32-288-GL32	03029357	C8	GL32	32,0 1.260	288,0 11.339	255,0 10.039	245,0 9.646	341,5 13.445	84,7 3.335	6000	1	PB	3,6 7.940
C8-D40-288-GL40	03029358	C8	GL40	40,0 1.575	288,0 11.339	255,0 10.039	245,0 9.646	341,5 13.445	102,14 4.021	6000	1	PB	4,7 10.360
C8-D40-368-GL40	03029359	C8	GL40	40,0 1.575	368,0 14.488	335,0 13.189	325,0 12.795	422,5 16.634	144,04 5.671	5000	1	PB	5,6 12.350
C8-D50-268-GL50	03029360	C8	GL50	50,0 1.969	268,0 10.551	235,0 9.252	225,0 8.858	323,4 12.732	107,59 4.236	6000	1	PB	5,9 13.010
C8-D50-368-GL50	03029361	C8	GL50	50,0 1.969	368,0 14.488	335,0 13.189	325,0 12.795	423,4 16.669	158,08 6.224	4000	1	PB	7,5 16.530
C8-D50-468-GL50	03029362	C8	GL50	50,0 1.969	468,0 18.425	435,0 17.126	425,0 16.732	523,4 20.606	215,6 8.488	2500	1	PB	9,4 20.720

Spare Parts

For size	Locking key
	
GL25	SL25
GL32	SL32
GL40	SL40
GL50	SL50

Accessories

For size	Replaceable end	Torque key
		
GL25	-	-
GL32	SL00-32	SL00-32.250
GL40	SL00-40	SL00-40.350
GL50	SL00-50	SL00-50.550

General ISO Turning

Steadyline®

MDT

Mini-Shaft™

Grooving

Parting-off

X4

Adapters Clamping units

Accessories and Spare parts

Workpiece materials

General ISO Turning

BA – Steadylin[®], BA holders, body diameters 60 and 80 mm / 2.362 and 3.150 inch – Metric/ Inch

Steadyline®

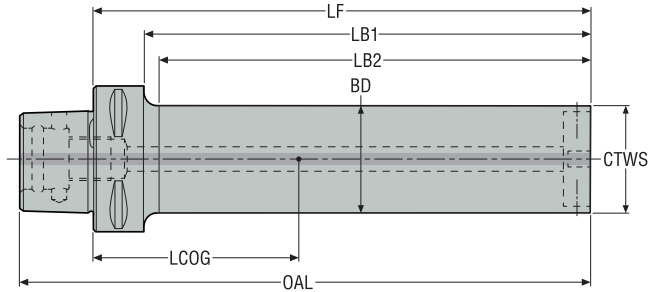

MDT

- With dynamic damping, ready to use
- To hold BA to GL adapters with GL turning heads
- With through coolant
- For BA-to-GL adapters program, see page 619
- For GL heads program, see page(s) 621-659
- * Max. RPM only when used in rotating boring
- Please check availability at www.secotools.com / Seco Online Store

Mini-Shaft™

Designation	Item number	CTMS Seco-Capto™ size	CTWS BA size	BD	LF	LB1	LB2	OAL	LCOG	Max. RPM*	RFID hole	Balancing	Weight
				mm Inch	mm Inch	mm Inch	mm Inch	mm Inch	mm Inch				
C6-D60-301-BA060	03062831	C6	BA060	60,0 2.362	301,0 11.850	276,0 10.866	273,0 10.748	339,0 13.346	151,74 5.974	4000	1	PB	7,8 17.200
C6-D60-421-BA060	03062832	C6	BA060	60,0 2.362	421,0 16.575	396,0 15.591	393,0 15.472	459,0 18.071	218,63 8.607	3000	1	PB	10,6 23.370
C8-D60-301-BA060	03062833	C8	BA060	60,0 2.362	301,0 11.850	268,0 10.551	263,0 10.354	349,0 13.740	137,04 5.395	4000	1	PB	8,6 18.960
C8-D60-421-BA060	03062834	C8	BA060	60,0 2.362	421,0 16.575	388,0 15.276	383,0 15.079	469,0 18.465	202,5 7.972	3000	1	PB	11,4 25.130
C8-D60-541-BA060	03062835	C8	BA060	60,0 2.362	541,0 21.299	508,0 20.000	503,0 19.803	589,0 23.189	266,78 10.503	2000	1	PB	14,0 30.860
C8-D80-421-BA080	03065829	C8	BA080	80,0 3.150	421,0 16.575	388,0 15.276	383,0 15.079	469,0 18.465	213,89 8.421	3000	1	PB	18,8 41.450
C8-D80-581-BA080	03065830	C8	BA080	80,0 3.150	581,0 22.874	548,0 21.575	543,0 21.378	629,0 24.764	300,38 11.826	2000	1	PB	25,1 55.340

Grooving

Parting-off

X4

Spare Parts

For size	Locking screw
BA060	90FQ4
BA080	90FQ52

Adapters Clamping units

Accessories

For size	Locking key
BA060	03H04
BA080	03H05

Workpiece materials

GL – Steadyline®, GL holders, body diameters 25, 32, 40 and 50 mm / 0.984, 1.260, 1.575 and 1.969 inch, steel or carbide – Metric / Inch

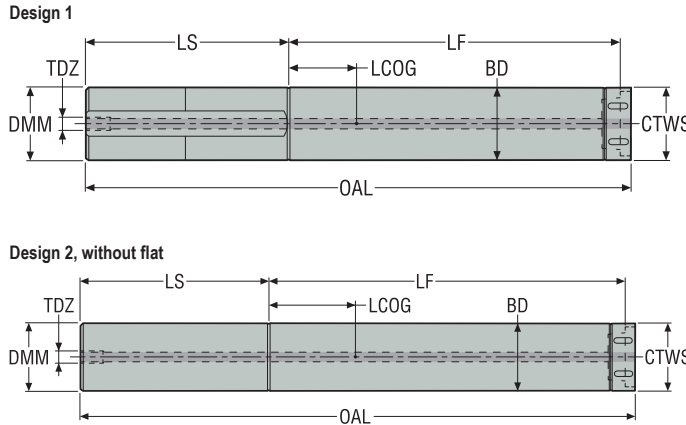

- With dynamic damping, ready to use
- With through coolant channel and coolant supply connecting thread
- For GL heads program, see page(s) 621-659
- * Dxx...-CR holders feature carbide-reinforced bodies to increase the rigidity of small diameter bars with 10xD overhang
- Please check availability at www.secotools.com / Seco Online Store

Designation	Item number	CTMS	CTWS	LF	BD	LS	OAL	LCOG	TDZ	Design	RFID hole	Weight
		DMM	GL size									
D25-130-GL25	03214280	25,0 0.984	GL25	130,0 5.118	25,0 0.984	100,0 3.937	234,5 9.232	25,5 1.004	G 1/4	1	0	0,9 1.980
D25-180-GL25	03214281	25,0 0.984	GL25	180,0 7.087	25,0 0.984	100,0 3.937	284,5 11.201	52,8 2.079	G 1/4	2	0	1,1 2.430
D25-230-GL25-CR	03214282	25,0 0.984	GL25	230,0 9.055	25,0 0.984	75,0 2.953	309,5 12.185	70,2 2.764	M8x1	2	0	1,7 3.750
D32-160-GL32	02807855	32,0 1.260	GL32	160,0 6.299	32,0 1.260	128,0 5.039	293,4 11.551	25,31 0.996	G 1/4	1	0	1,8 3.970
D32-224-GL32	02807856	32,0 1.260	GL32	224,0 8.819	32,0 1.260	128,0 5.039	357,4 14.071	60,23 2.371	G 1/4	1	0	2,3 5.070
D32-288-GL32-CR	03334786	32,0 1.260	GL32	288,0 11.339	32,0 1.260	96,0 3.780	389,4 15.331	84,3 3.319	M8x1	1	0	3,7 8.160
D40-208-GL40	02807858	40,0 1.575	GL40	208,0 8.189	40,0 1.575	160,0 6.299	374,4 14.740	35,56 1.400	G 1/4	1	0	3,8 8.380
D40-288-GL40	02807859	40,0 1.575	GL40	288,0 11.339	40,0 1.575	160,0 6.299	454,4 17.890	78,26 3.081	G 1/4	1	0	4,6 10.140
D40-368-GL40	02807860	40,0 1.575	GL40	368,0 14.488	40,0 1.575	160,0 6.299	534,4 21.039	124,33 4.895	G 1/4	2	0	5,5 12.130
D50-268-GL50	02807861	50,0 1.969	GL50	268,0 10.551	50,0 1.969	200,0 7.874	475,4 18.717	46,44 1.828	G 1/4	1	0	7,5 16.530
D50-368-GL50	02807862	50,0 1.969	GL50	368,0 14.488	50,0 1.969	200,0 7.874	575,4 22.654	99,02 3.898	G 1/4	1	0	9,1 20.060
D50-468-GL50	02807863	50,0 1.969	GL50	468,0 18.425	50,0 1.969	200,0 7.874	675,4 26.591	158,07 6.223	G 1/4	2	0	11,0 24.250

Spare Parts

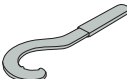
For size	Coolant adapter	Locking key
GL25		
GL25	-	SL25
GL25-CR	904JET08G1/4L	SL25
GL32	-	SL32
GL32-CR	904JET08G1/4L	SL32
GL40	-	SL40
GL50	-	SL50

General ISO Turning

Steadyline®

MDT

Mini-Shaft™

Grooving

Parting-off

X4

Adapters
Clamping units

Accessories and
Spare parts

Workpiece
materials

Accessories

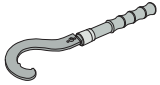
For size	Replaceable end	Torque key
		
GL25	-	-
GL25-CR	-	-
GL32	SL00-32	SL00-32.250
GL32-CR	SL00-32	SL00-32.250
GL40	SL00-40	SL00-40.350
GL50	SL00-50	SL00-50.550

General ISO Turning

Steadyline®

MDT

Mini-Shaft™

Grooving

Parting-off

X4

Adapters
Clamping units

Accessories and
Spare parts

Workpiece
materials

GL –Steadyline®, GL holders, body diameters 1.00, 1.25, 1.59 and 2.00 inch, steel or carbide – Inch

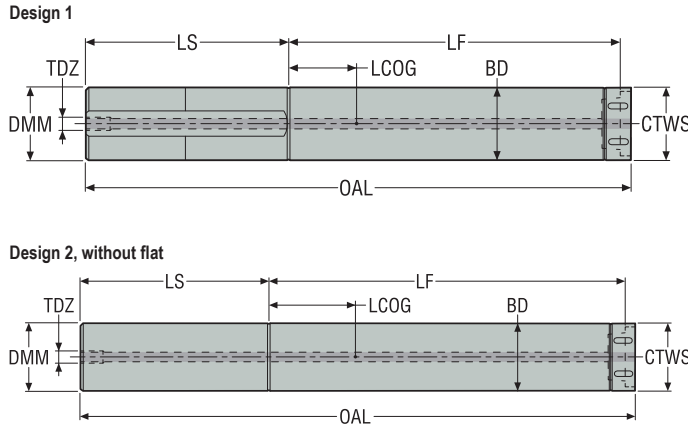

- With dynamic damping, ready to use
- With through coolant channel and coolant supply connecting thread
- For GL heads program, see page(s) 621-659
- * Dxx...-CR holders feature carbide-reinforced bodies to increase the rigidity of small diameter bars with 10xD overhang
- Please check availability at www.secotools.com / Seco Online Store

Designation	Item number	CTMS DMM	CTWS GL size	LF	BD	LS	OAL	LCOG	TDZ	Design	RFID hole	Weight
		Inch		Inch	Inch	Inch	Inch	Inch				lbs
DA16-5.25-GL25	03214286	1.000	GL25	5.250	1.000	4.000	9.427	1.031	G 1/4	1	0	1.980
DA16-7.25-GL25	03214287	1.000	GL25	7.250	1.000	4.000	11.427	2.118	G 1/4	2	0	3.750
DA16-9.25-GL25-CR	03214288	1.000	GL25	9.252	1.000	3.000	12.429	2.819	M8x1	2	0	4.190
DA20-6.50-GL32	02807928	1.250	GL32	6.500	1.260	5.000	11.713	1.139	G 1/4	1	0	3.970
DA20-9.00-GL32	02807929	1.250	GL32	9.000	1.260	5.000	14.213	2.509	G 1/4	1	0	5.070
DA20-11.50-GL32-CR	03334787	1.250	GL32	11.500	1.250	3.750	15.463	3.429	M8x1	2	0	9.260
DA24-8.00-GL40	02807931	1.500	GL40	8.000	1.575	6.000	14.252	1.621	G 1/4	1	0	7.720
DA24-11.00-GL40	02807933	1.500	GL40	11.000	1.575	6.000	17.252	3.244	G 1/4	1	0	9.480
DA24-14.00-GL40	02807935	1.500	GL40	14.000	1.575	6.000	20.252	4.991	G 1/4	2	0	11.460
DA32-10.50-GL50	02807936	2.000	GL50	10.500	1.969	8.000	18.791	1.667	G 1/4	1	0	16.760
DA32-14.50-GL50	02807937	2.000	GL50	14.500	1.969	8.000	22.791	3.762	G 1/4	1	0	20.280
DA32-18.50-GL50	02807938	2.000	GL50	18.500	1.969	8.000	26.791	6.111	G 1/4	2	0	24.470

Spare Parts

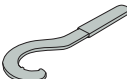
For size	Coolant adapter	Locking key
GL25		
GL25-CR	904JET08G1/4L	SL25
GL32	-	SL32
GL32-CR	904JET08G1/4L	SL32
GL40	-	SL40
GL50	-	SL50

General ISO Turning

Steadyline®

MDT

Mini-Shaft™

Grooving

Parting-off

X4

Adapters Clamping units

Accessories and Spare parts

Workpiece materials

Accessories

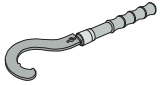
For size	Replaceable end	Torque key
		
GL25	-	-
GL25-CR	-	-
GL32	SL00-32	SL00-32.250
GL32-CR	SL00-32	SL00-32.250
GL40	SL00-40	SL00-40.350
GL50	SL00-50	SL00-50.550

General ISO Turning

Steadyline®

MDT

Mini-Shaft™

Grooving

Parting-off

X4

Adapters
Clamping units

Accessories and
Spare parts

Workpiece
materials

GL – Steadyline® turning, BA holders, body diameters 2.50, 3.00 and 4.00 inch – Inch

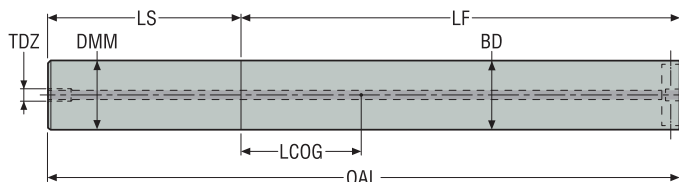

- With dynamic damping, ready to use
- With through coolant channel and coolant supply connecting thread
- For BA-to-GL adapters program, see page 619-620
- For GL heads program, see page(s) 621-659
- Please check availability at www.secotools.com / Seco Online Store

Designation	Item number	CTMS DMM	CTWS GL size	LF	BD	LS	OAL	LCOG	TDZ	Design	RFID hole	Weight
		Inch		Inch	Inch	Inch	Inch	Inch				lbs
DA40-12.50-BA06I	03064142	2.500	BA06I	12.500	2.500	10.000	22.500	1.960	G 3/4	2	0	32.410
DA40-22.50-BA06I	03064143	2.500	BA06I	22.500	2.500	10.000	32.500	7.290	G 3/4	2	0	46.740
DA48-15.50-BA08I	03064145	3.000	BA08I	15.500	3.000	12.000	27.500	2.600	G 3/4	2	0	57.540
DA48-27.50-BA08I	03064147	3.000	BA08I	27.500	3.000	12.000	39.500	9.050	G 3/4	2	0	83.110
DA64-37.50-BA100	03139336	4.000	BA100	37.500	4.000	20.000	57.500	10.750	G 3/4	2	0	222.670

Spare Parts

For size	Locking screw
BA06I	90FQ4
BA08I	90FQ52
BA100	90FQ6

Accessories

For size	Locking key
BA06I	03H04
BA08I	03H05
BA100	03H06

General ISO Turning

Steadyline®

MDT

Mini-Shaft™

Grooving

Parting-off

X4

Adapters Clamping units

Accessories and Spare parts

Workpiece materials

General ISO Turning

BA – Steadylin[®], BA holders, body diameters 60, 80 and 100 mm / 2.362, 3.150 and 3.937 inch – Metric/ Inch

Steadyline®

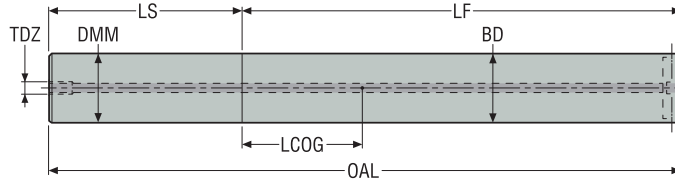

MDT

- With dynamic damping, ready to use
- To hold BA to GL adapters with GL turning heads
- With through coolant
- For BA-to-GL adapters program, see page 619
- For GL heads program, see page(s) 621-659
- Please check availability at www.secotools.com / Seco Online Store

Mini-Shaft™

Designation	Item number	CTMS DMM	CTWS BA size	LF	BD	LS	OAL	LCOG	TDZ	RFID hole	Weight
		mm Inch		mm Inch	mm Inch	mm Inch	mm Inch	mm Inch			kg lbs
D60-301-BA060	03062826	60,0 2.362	BA060	301,0 11.850	60,0 2.362	240,0 9.449	541,0 21.299	50,06 1.971	G 3/4	0	12,5 27.560
D60-541-BA060	03062827	60,0 2.362	BA060	541,0 21.299	60,0 2.362	240,0 9.449	781,0 30.748	179,12 7.052	G 3/4	0	18,1 39.900
D80-421-BA080	03062862	80,0 3.150	BA080	421,0 16.575	80,0 3.150	320,0 12.598	741,0 29.173	71,0 2.795	G 3/4	0	30,2 66.580
D80-741-BA080	03062863	80,0 3.150	BA080	741,0 29.173	80,0 3.150	320,0 12.598	1061,0 41.772	241,55 9.510	G 3/4	0	43,4 95.680
D100-939-BA100	03139335	100,0 3.937	BA100	939,0 36.969	100,0 3.937	500,0 19.685	1439,0 56.654	271,9 10.705	G 3/4	0	84,7 186.730

Grooving

Parting-off

Spare Parts

For size	Locking screw
BA060	90FQ4
BA080	90FQ52
BA100	90FQ6

X4

Adapters Clamping units

Accessories

For size	Locking key
BA060	03H04
BA080	03H05
BA100	03H06

Accessories and Spare parts

Workpiece materials

BA – BA-to-GL adapters – Metric/ Inch

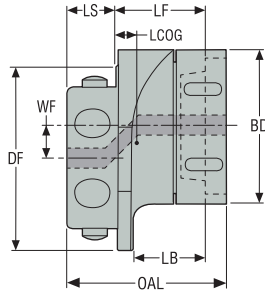

- To hold GL50 turning heads on Steadyliner® BA holders
- Each adapter size available with 2 radial offset sizes WF: when possible, preferably use the widest offset
- With through coolant
- For GL heads program, see page(s) 621-659
- Please check availability at www.secotools.com / Seco Online Store

Designation	Item number	Machine side CTMS	Workpiece side GL size CTWS	WF	LF	DF	BD	LB	LS	OAL	LCOG	RFID hole	Weight
				mm Inch	mm Inch	mm Inch	mm Inch	mm Inch	mm Inch	mm Inch			
BA060-05-27-GL50	03065832	BA060	GL50	5,0 0.197	27,0 1.063	60,0 2.362	50,0 1.969	21,5 0.846	16,0 0.630	50,4 1.984	5,82 0.229	0	0,6 1.320
BA060-10-27-GL50	03065833	BA060	GL50	10,0 0.394	27,0 1.063	60,0 2.362	50,0 1.969	21,5 0.846	16,0 0.630	50,4 1.984	5,79 0.228	0	0,6 1.320
BA080-15-27-GL50	03065834	BA080	GL50	15,0 0.591	27,0 1.063	80,0 3.150	50,0 1.969	21,5 0.846	22,0 0.866	56,4 2.220	1,42 0.056	0	0,9 1.980
BA080-23-27-GL50	03065835	BA080	GL50	23,0 0.906	27,0 1.063	80,0 3.150	50,0 1.969	21,5 0.846	22,0 0.866	56,4 2.220	1,42 0.056	0	0,9 1.980
BA100-28-29-GL50	03139337	BA100	GL50	28,0 1.102	29,0 1.142	100,0 3.937	50,0 1.969	21,5 0.846	25,0 0.984	61,4 2.417	-1,31 -0.052	0	1,5 3.310
BA100-38-29-GL50	03139338	BA100	GL50	38,0 1.496	29,0 1.142	100,0 3.937	50,0 1.969	21,5 0.846	25,0 0.984	61,4 2.417	-1,23 -0.048	0	1,5 3.310

Spare Parts

For size	Locking key
GL50	SL50

Accessories

For size	Replaceable end	Torque key
GL50	SL00-50	SL00-50.550

General ISO Turning

Steadyline®

MDT

Mini-Shaft™

Grooving

Parting-off

X4

Adapters
Clamping units

Accessories and
Spare parts

Workpiece
materials

General ISO Turning

BA – BA-to-GL adapters – Inch

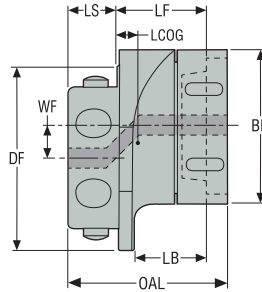

Steadyline®

MDT

- To hold GL50 turning heads on Steadyline® BA holders
- Each adapter size available with 2 radial offset sizes WF: when possible, preferably use the widest offset
- With through coolant
- For GL heads program, see page(s) 621-659
- Please check availability at www.secotools.com / Seco Online Store

Mini-Shaft™

Designation	Item number	Machine side CTMS	Workpiece side GL size CTWS	WF	LF	DF	BD	LB	LS	OAL	LCOG	RFID hole	Weight
				Inch	Inch	Inch	Inch	Inch	Inch	Inch	Inch	Inch	Inch
BA06I-06.75-27-GL50	03065836	BA06I	GL50	0.266	1.063	2.500	1.969	0.846	0.630	1.984	0.227	0	2.200
BA06I-11.75-27-GL50	03065837	BA06I	GL50	0.463	1.063	2.500	1.969	0.846	0.630	1.984	0.226	0	2.200
BA08I-13.10-27-GL50	03065838	BA08I	GL50	0.516	1.063	3.000	1.969	0.846	0.866	2.220	0.054	0	1.980
BA08I-21.10-27-GL50	03065839	BA08I	GL50	0.831	1.063	3.000	1.969	0.846	0.866	2.220	0.055	0	1.980

Grooving

Spare Parts

Parting-off

For size	Locking key
GL50	SL50

X4

Accessories

For size	Replaceable end	Torque key
GL50	SL00-50	SL00-50.550

Adapters Clamping units

Accessories and Spare parts

Workpiece materials

GL..-DCLCR/L – Toolholders for inserts CCGT, CCGW, CCMT and CCMW – Metric/ Inch

GL..-DCLCR/L
KAPR = 95,0°

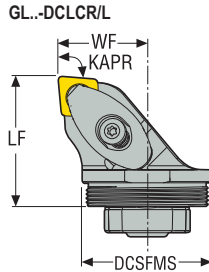
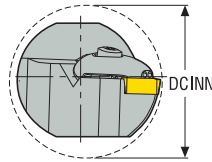
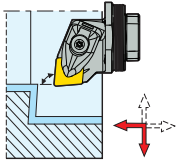

- For inserts program, see page(s) 522, 523, 524, 525, 573, 574, 597, 599
- For more information on Jetstream Tooling® (High pressure coolant) and accessories, please see page(s) 38, 85-89, 1002
- GAMO° = Rake angle, LAMS° = Inclination angle CTMS = GL size
- CTMS = GL size
- CTWS = Insert shape and size
- For holder code key, see page(s) 19
- For coolant clamps code key, see page(s) 25
- For damping holders program, see page(s) 607, 608-620
- * Type of Steadyline bar might limit the maximum coolant pressure, please see page(s) 85
- Right-hand version shown
- Please check availability at www.secotools.com / Seco Online Store

Designation	Item number	CTMS	DCSFMS		WF		LF	DCINN	CP*	KAPR°	GAMO°	LAMS°	Weight	CTWS				
			mm	Inch	mm	Inch									mm	Inch		
GL32-DCLCR-22032-09JET	02994382	GL32	32,0	1.260	22,0	0.866	32	1.260	40,0	1.575	200,0	2900.8	95,0	0,0	-2,0	0,2	0.440	CC..09T3.. CC..32.5
GL32-DCLCL-22032-09JET	02994379	GL32	32,0	1.260	22,0	0.866	32	1.260	40,0	1.575	200,0	2900.8	95,0	0,0	-2,0	0,2	0.440	CC..09T3.. CC..32.5
GL40-DCLCR-27032-09JET	02994389	GL40	40,0	1.575	27,0	1.063	32	1.260	50,0	1.969	200,0	2900.8	95,0	0,0	-2,0	0,2	0.440	CC..09T3.. CC..32.5
GL40-DCLCL-27032-09JET	02994386	GL40	40,0	1.575	27,0	1.063	32	1.260	50,0	1.969	200,0	2900.8	95,0	0,0	-2,0	0,2	0.440	CC..09T3.. CC..32.5
GL50-DCLCR-32032-09JET	02994395	GL50	50,0	1.969	32,0	1.260	32	1.260	63,0	2.480	200,0	2900.8	95,0	0,0	-2,0	0,3	0.660	CC..09T3.. CC..32.5
GL50-DCLCL-32032-09JET	02994392	GL50	50,0	1.969	32,0	1.260	32	1.260	63,0	2.480	200,0	2900.8	95,0	0,0	-2,0	0,3	0.660	CC..09T3.. CC..32.5

Spare Parts

For size	Clamp key	Clamp screw	Coolant kit	Coolant seal	Key (T-handle)	O-ring	Spring
GL32	H4B-T09P	L84017-T09P	CP14U00S-2-SET	930RD13	DOUBLE-T	O-RING-5.0X1.2	S5608
GL40	H4B-T09P	L84017-T09P	CP14U00S-2-SET	930RD13	DOUBLE-T	O-RING-5.0X1.2	S5608
GL50	H4B-T09P	L84017-T09P	CP14U00S-2-SET	930RD13	DOUBLE-T	O-RING-5.0X1.2	S5608

Accessories

For size	Insert clamping torque	Replacement blade	Torque key
GL32	2.0NM	T00-09P	T00-09P20
GL40	2.0NM	T00-09P	T00-09P20
GL50	2.0NM	T00-09P	T00-09P20

General ISO Turning

Steadyline®

MDT

Mini-Shaft™

Grooving

Parting-off

X4

Adapters
Clamping units

Accessories and
Spare parts

Workpiece
materials

GL..-DCLNR/L – Toolholders for inserts CNGG, CNMA, CNMG and CNMM – Metric/ Inch

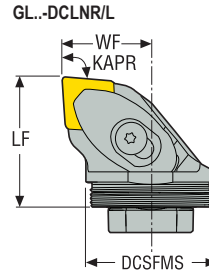
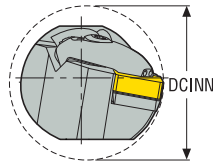

GL..-DCLNR/L
KAPR = 95,0 °

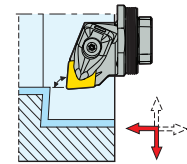

CTWS



- For inserts program, see page(s) 527, 528, 529, 530, 531, 532, 533
- For more information on Jetstream Tooling® (High pressure coolant) and accessories, please see page(s) 38, 85-89, 1002
- GAMO° = Rake angle, LAMS° = Inclination angle
- CTMS = GL size
- CTWS = Insert shape and size
- For holder code key, see page(s) 19
- For coolant clamps code key, see page(s) 25
- For damping holders program, see page(s) 607, 608-620
- * Type of Steadyline bar might limit the maximum coolant pressure, please see page(s) 85
- Right-hand version shown
- Please check availability at www.secotools.com / Seco Online Store

Designation	Item number	CTMS	DCSFMS		WF	LF	DCINN	CP*	KAPR°	GAMO°	LAMS°	Weight	CTWS				
			mm	Inch										mm	Inch		
GL32-DCLNR-22032-12JET	02994325	GL32	32,0	1.260	22,0	0.866	32	1.260	40,0	1.575	200,0	2900.8	95,0	-6,0	-10,0	0,2	CN..1204.. CN..43.
GL32-DCLNL-22032-12JET	02994324	GL32	32,0	1.260	22,0	0.866	32	1.260	40,0	1.575	200,0	2900.8	95,0	-6,0	-10,0	0,2	CN..1204.. CN..43.
GL40-DCLNR-27032-12JET	02994341	GL40	40,0	1.575	27,0	1.063	32	1.260	50,0	1.969	200,0	2900.8	95,0	-6,0	-10,0	0,2	CN..1204.. CN..43.
GL40-DCLNL-27032-12JET	02994340	GL40	40,0	1.575	27,0	1.063	32	1.260	50,0	1.969	200,0	2900.8	95,0	-6,0	-10,0	0,2	CN..1204.. CN..43.
GL50-DCLNR-32032-12JET	02994354	GL50	50,0	1.969	32,0	1.260	32	1.260	63,0	2.480	200,0	2900.8	95,0	-6,0	-8,0	0,3	CN..1204.. CN..43.
GL50-DCLNL-32032-12JET	02994351	GL50	50,0	1.969	32,0	1.260	32	1.260	63,0	2.480	200,0	2900.8	95,0	-6,0	-8,0	0,3	CN..1204.. CN..43.

Spare Parts

For size	Clamp screw	Coolant kit	Coolant seal	Insert shim	Key (T-handle)	O-ring	Shim/clamp key	Shim screw	Spring
GL32	L85021-T15P	CN17U00S-2-SET	930RD13	DCO120310	DOUBLE-T	O-RING-5.0X1.2	H4B-T15P	C04008-T15P	S6912
GL40	L85021-T15P	CN17U00S-2-SET	930RD13	DCO120310	DOUBLE-T	O-RING-5.0X1.2	H4B-T15P	C04008-T15P	S6912
GL50	L85021-T15P	CN17U00S-2-SET	930RD13	DCO120310	DOUBLE-T	O-RING-5.0X1.2	H4B-T15P	C04008-T15P	S6912

Accessories

For size	Insert clamping torque	Replacement blade	Torque key
GL32	3.5NM	T00-15P	T00-15P35
GL40	3.5NM	T00-15P	T00-15P35
GL50	3.5NM	T00-15P	T00-15P35

GL...DDUCR/L – Toolholders for inserts DCGT, DCGW, DCMT, DCMW and DCMX – Metric/ Inch



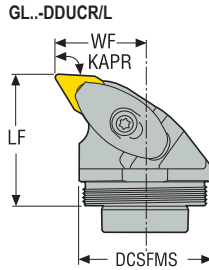
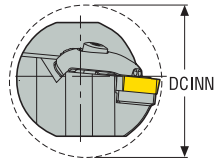
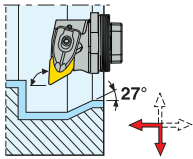













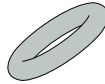









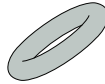



GL...DDUCR/L
KAPR = 93,0°

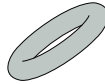

- For inserts program, see page(s) 534, 535, 536, 578, 600
- For more information on Jetstream Tooling® (High pressure coolant) and accessories, please see page(s) 38, 85-89, 1002
- GAMO° = Rake angle, LAMS° = Inclination angle
- CTMS = GL size
- CTWS = Insert shape and size
- For holder code key, see page(s) 19
- For coolant clamps code key, see page(s) 25
- For damping holders program, see page(s) 607, 608-620
- * Type of Steadyline bar might limit the maximum coolant pressure, please see page(s) 85
- Right-hand version shown
- Please check availability at www.secotools.com / Seco Online Store

Designation	Item number	CTMS	DCSFMS		WF		LF		DCINN	CP*	KAPR°	GAMO°	LAMS°	Weight	CTWS		
			mm	Inch	mm	Inch	mm	Inch								mm	Inch
GL32-DDUCR-22032-11JET	02994499	GL32	32,0	1.260	22,0	0.866	32	1.260	40,0	1.575	200,0	2900.8	93,0	0,0	-5,0	0,2	DC..11T3.. DC..32.5
GL32-DDUCL-22032-11JET	02994496	GL32	32,0	1.260	22,0	0.866	32	1.260	40,0	1.575	200,0	2900.8	93,0	0,0	-5,0	0,2	DC..11T3.. DC..32.5
GL40-DDUCR-27032-11JET	02994556	GL40	40,0	1.575	27,0	1.063	32	1.260	50,0	1.969	200,0	2900.8	93,0	0,0	-5,0	0,2	DC..11T3.. DC..32.5
GL40-DDUCL-27032-11JET	02994555	GL40	40,0	1.575	27,0	1.063	32	1.260	50,0	1.969	200,0	2900.8	93,0	0,0	-5,0	0,2	DC..11T3.. DC..32.5
GL50-DDUCR-32032-11JET	02994558	GL50	50,0	1.969	32,0	1.260	32	1.260	63,0	2.480	200,0	2900.8	93,0	0,0	-5,0	0,3	DC..11T3.. DC..32.5
GL50-DDUCL-32032-11JET	02994557	GL50	50,0	1.969	32,0	1.260	32	1.260	63,0	2.480	200,0	2900.8	93,0	0,0	-5,0	0,3	DC..11T3.. DC..32.5

Spare Parts

For size	Clamp key	Clamp screw	Coolant kit	Coolant seal	Insert shim	Key (T-handle)	O-ring	Shim key	Shim screw	Spring
GL32	 H4B-T09P	 L84017-T09P	 CP14U00S-2-SET	 930RD13	 126.19-620	 DOUBLE-T	 O-RING-5.0X1.2	 H4B-T15P	 C94006-T15P	 S5608
GL40	 H4B-T09P	 L84017-T09P	 CP14U00S-2-SET	 930RD13	 126.19-620	 DOUBLE-T	 O-RING-5.0X1.2	 H4B-T15P	 C94006-T15P	 S5608
GL50	 H4B-T09P	 L84017-T09P	 CP14U00S-2-SET	 930RD13	 126.19-620	 DOUBLE-T	 O-RING-5.0X1.2	 H4B-T15P	 C94006-T15P	 S5608

General ISO Turning

Steadyline®

MDT

Mini-Shaft™

Grooving

Parting-off



X4

Adapters
Clamping units

Accessories and
Spare parts

Workpiece
materials

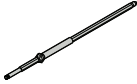
Accessories

For size	Insert clamping torque	Replacement blade	Torque key
GL32	2.0NM 	T00-09P 	T00-09P20 
GL40	2.0NM	T00-09P	T00-09P20
GL50	2.0NM	T00-09P	T00-09P20

General ISO Turning

Steadyline®

MDT

Mini-Shaft™

Grooving

Parting-off

X4

Adapters
Clamping units

Accessories and
Spare parts

Workpiece
materials

GL..-DDUNR/L – Toolholders for inserts DNGG, DNGN, DNMA, DNMG, DNMM, DNMU and DNMX – Metric/ Inch

GL..-DDUNR/L
KAPR = 93,0°

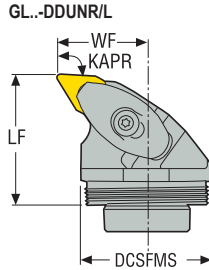
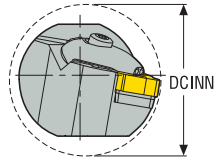
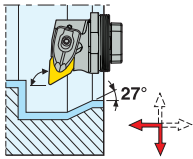

- For inserts program, see page(s) 537, 538, 539, 540, 541, 580
- For more information on Jetstream Tooling® (High pressure coolant) and accessories, please see page(s) 38, 85-89, 1002
- GAMO° = Rake angle, LAMS° = Inclination angle
- CTMS = GL size
- CTWS = Insert shape and size
- For holder code key, see page(s) 19
- For coolant clamps code key, see page(s) 25
- For damping holders program, see page(s) 607, 608-620
- * Type of Steadyline bar might limit the maximum coolant pressure, please see page(s) 85
- Right-hand version shown
- Please check availability at www.secotools.com / Seco Online Store

Designation	Item number	CTMS	DCSFMS		WF	LF	DCINN	CP*	KAPR°	GAMO°	LAMS°	Weight	CTWS
			mm	Inch									
GL32-DDUNR-22032-11JET	02994328	GL32	32,0 1.260	22,0 0.866	32 1.260	40,0 1.575	200,0 2900.8	93,0	-6,0	-10,0	0,2 0.440	DNMU1104.. DNMU33.	
GL32-DDUNL-22032-11JET	02994326	GL32	32,0 1.260	22,0 0.866	32 1.260	40,0 1.575	200,0 2900.8	93,0	-6,0	-10,0	0,2 0.440	DNMU1104.. DNMU33.	
GL32-DDUNR-22032-15JET	02994329	GL32	32,0 1.260	22,0 0.866	32 1.260	40,0 1.575	200,0 2900.8	93,0	-6,0	-14,0	0,2 0.440	DN.1504 DN..1506- DN..43 DN..44*	
GL32-DDUNL-22032-15JET	02994327	GL32	32,0 1.260	22,0 0.866	32 1.260	40,0 1.575	200,0 2900.8	93,0	-6,0	-14,0	0,2 0.440	DN.1504 DN..1506- DN..43 DN..44*	
GL40-DDUNR-27032-11JET	02994345	GL40	40,0 1.575	27,0 1.063	32 1.260	50,0 1.969	200,0 2900.8	93,0	-5,0	-10,0	0,2 0.440	DNMU1104.. DNMU33.	
GL40-DDUNL-27032-11JET	02994342	GL40	40,0 1.575	27,0 1.063	32 1.260	50,0 1.969	200,0 2900.8	93,0	-5,0	-10,0	0,2 0.440	DNMU1104.. DNMU33.	
GL40-DDUNR-27032-15JET	02994346	GL40	40,0 1.575	27,0 1.063	32 1.260	50,0 1.969	200,0 2900.8	93,0	-6,0	-14,0	0,2 0.440	DN.1504 DN..1506- DN..43 DN..44*	
GL40-DDUNL-27032-15JET	02994343	GL40	40,0 1.575	27,0 1.063	32 1.260	50,0 1.969	200,0 2900.8	93,0	-6,0	-14,0	0,2 0.440	DN.1504 DN..1506- DN..43 DN..44*	
GL50-DDUNR-32032-15JET	02994358	GL50	50,0 1.969	32,0 1.260	32 1.260	63,0 2.480	200,0 2900.8	93,0	-6,0	-14,0	0,4 0.880	DN.1504 DN..1506- DN..43 DN..44*	
GL50-DDUNL-32032-15JET	02994357	GL50	50,0 1.969	32,0 1.260	32 1.260	63,0 2.480	200,0 2900.8	93,0	-6,0	-14,0	0,4 0.880	DN.1504 DN..1506- DN..43 DN..44*	

General ISO Turning

Steadyline®

MDT

Mini-Shaft™

Grooving

Parting-off

X4

Adapters
Clamping units

Accessories and
Spare parts

Workpiece
materials

Spare Parts

For size	Clamp key	Clamp screw	Coolant kit	Coolant seal	Insert shim	Key (T-handle)	O-ring	Shim/clamp key	Shim key	Shim screw	Spring
32-11	-	L84017-T09P	CX14U00S-2-SET	930RD13	DDN110310	DOUBLE-T	O-RING-5.0X1.2	H4B-T09P	-	C03007-T09P	S5608
32R-15	H4B-T09P	L84017-T09P	CN14U10S-2R-SET	930RD13	DDN150416	DOUBLE-T	O-RING-5.0X1.2	-	H4B-T15P	C04008-T15P	S5608
32L-15	H4B-T09P	L84017-T09P	CN14U10S-2L-SET	930RD13	DDN150416	DOUBLE-T	O-RING-5.0X1.2	-	H4B-T15P	C04008-T15P	S5608
40-11	-	L84017-T09P	CX14U00S-2-SET	930RD13	DDN110310	DOUBLE-T	O-RING-5.0X1.2	H4B-T09P	-	C03007-T09P	S5608
40-15	-	L85021-T15P	CN17U00S-2-SET	930RD13	DDN150416	DOUBLE-T	O-RING-5.0X1.2	H4B-T15P	-	C04008-T15P	S6912
50-15	-	L85021-T15P	CN17U00S-2-SET	930RD13	DDN150416	DOUBLE-T	O-RING-5.0X1.2	H4B-T15P	-	C04008-T15P	S6912

Accessories

For size	Insert clamping torque	Replacement blade	Torque key
32-11	2.0NM	T00-09P	T00-09P20
32R-15	2.0NM	T00-09P	T00-09P20
32L-15	2.0NM	T00-09P	T00-09P20
40-11	2.0NM	T00-09P	T00-09P20
40-15	3.5NM	T00-15P	T00-15P35
50-15	3.5NM	T00-15P	T00-15P35

General ISO Turning

Steadyline®

MDT

Mini-Shaft™

Grooving

Parting-off

X4

Adapters
Clamping units

Accessories and
Spare parts

Workpiece
materials

GL...DVUBR/L – Toolholders for inserts VBGT, VBGW, VBMT and BMW – Metric/ Inch

GL...DVUBR/L
KAPR = 93,0°

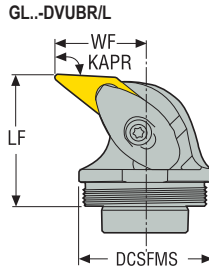
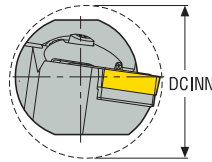
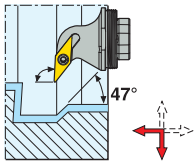

CTWS



- For inserts program, see page(s) 563, 564, 594, 602
- For more information on Jetstream Tooling® (High pressure coolant) and accessories, please see page(s) 38, 85-89, 1002
- GAMO° = Rake angle, LAMS° = Inclination angle
- CTMS = GL size
- CTWS = Insert shape and size
- For holder code key, see page(s) 19
- For coolant clamps code key, see page(s) 25
- For damping holders program, see page(s) 607, 608-620
- * Type of Steadyline bar might limit the maximum coolant pressure, please see page(s) 85
- Right-hand version shown
- Please check availability at www.secotools.com / Seco Online Store

Designation	Item number	CTMS	DCSFMS		WF		LF	DCINN	CP*	KAPR°	GAMO°	LAMS°	Weight	CTWS				
			mm	Inch	mm	Inch									mm	Inch		
GL32-DVUBR-22032-16JET	02994507	GL32	32,0	1.260	22,0	0.866	32	1.260	40,0	1.575	200,0	2900.8	93,0	0,0	-8,0	0,2	0.440	VB..1604.. VB..33
GL32-DVUBL-22032-16JET	02994506	GL32	32,0	1.260	22,0	0.866	32	1.260	40,0	1.575	200,0	2900.8	93,0	0,0	-8,0	0,2	0.440	VB..1604.. VB..33
GL40-DVUBR-27032-16JET	02994515	GL40	40,0	1.575	27,0	1.063	32	1.260	50,0	1.969	200,0	2900.8	93,0	0,0	-8,0	0,2	0.440	VB..1604.. VB..33
GL40-DVUBL-27032-16JET	02994514	GL40	40,0	1.575	27,0	1.063	32	1.260	50,0	1.969	200,0	2900.8	93,0	0,0	-8,0	0,2	0.440	VB..1604.. VB..33
GL50-DVUBR-32032-16JET	02994522	GL50	50,0	1.969	32,0	1.260	32	1.260	63,0	2.480	200,0	2900.8	93,0	0,0	-8,0	0,3	0.660	VB..1604.. VB..33
GL50-DVUBL-32032-16JET	02994521	GL50	50,0	1.969	32,0	1.260	32	1.260	63,0	2.480	200,0	2900.8	93,0	0,0	-8,0	0,3	0.660	VB..1604.. VB..33

Spare Parts

For size	Clamp key	Clamp screw	Coolant kit	Coolant seal	Insert shim	Key (T-handle)	O-ring	Shim key	Shim screw	Spring
GL32..R	H4B-T09P	L84017-T09P	CP14U20S-2R-SET	930RD13	171.19-620	DOUBLE-T	O-RING-5.0X1.2	H4B-T15P	C94006-T15P	S5608
GL32..L	H4B-T09P	L84017-T09P	CP14U20S-2L-SET	930RD13	171.19-620	DOUBLE-T	O-RING-5.0X1.2	H4B-T15P	C94006-T15P	S5608
GL40..R	H4B-T09P	L84017-T09P	CP14U20S-2R-SET	930RD13	171.19-620	DOUBLE-T	O-RING-5.0X1.2	H4B-T15P	C94006-T15P	S5608
GL40..L	H4B-T09P	L84017-T09P	CP14U20S-2L-SET	930RD13	171.19-620	DOUBLE-T	O-RING-5.0X1.2	H4B-T15P	C94006-T15P	S5608
GL50..R	H4B-T09P	L84017-T09P	CP14U20S-2R-SET	930RD13	171.19-620	DOUBLE-T	O-RING-5.0X1.2	H4B-T15P	C94006-T15P	S5608
GL50..L	H4B-T09P	L84017-T09P	CP14U20S-2L-SET	930RD13	171.19-620	DOUBLE-T	O-RING-5.0X1.2	H4B-T15P	C94006-T15P	S5608

General ISO Turning

Steadyline®

MDT

Mini-Shaft™

Grooving

Parting-off

X4

Adapters
Clamping units

Accessories and
Spare parts

Workpiece
materials

Accessories

For size	Insert clamping torque	Replacement blade	Torque key
GL32..R	2.0NM	T00-09P	T00-09P20
GL32..L	2.0NM	T00-09P	T00-09P20
GL40..R	2.0NM	T00-09P	T00-09P20
GL40..L	2.0NM	T00-09P	T00-09P20
GL50..R	2.0NM	T00-09P	T00-09P20
GL50..L	2.0NM	T00-09P	T00-09P20

General ISO Turning

Steadyline®

MDT

Mini-Shaft™

Grooving

Parting-off

X4

Adapters
Clamping units

Accessories and
Spare parts

Workpiece
materials



GL...DWLNR/L – Toolholders for inserts WNGG, WNMA, WNMG and WNMM – Metric/ Inch

GL...DWLNR/L
KAPR = 95,0°

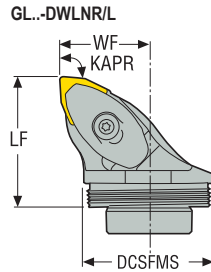
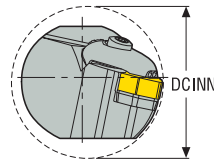
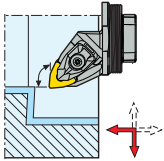

- For inserts program, see page(s) 568, 569, 570, 571, 596
- For more information on Jetstream Tooling® (High pressure coolant) and accessories, please see page(s) 38, 85-89, 1002
- GAMO° = Rake angle, LAMS° = Inclination angle
- CTMS = GL size
- CTWS = Insert shape and size
- For holder code key, see page(s) 19
- For coolant clamps code key, see page(s) 25
- For damping holders program, see page(s) 607, 608-620
- * Type of Steadyline bar might limit the maximum coolant pressure, please see page(s) 85
- Right-hand version shown
- Please check availability at www.secotools.com / Seco Online Store

Designation	Item number	CTMS	DCSFMS		WF	LF	DCINN	CP*	KAPR°	GAMO°	LAMS°	Weight	CTWS				
			mm	Inch													
GL32-DWLNR-22032-06JET	02994332	GL32	32,0	1.260	22,0	0.866	1.260	40,0	1.575	200,0	2900.8	95,0	-5,0	-12,0	0,2	0.440	WN..0604.. WN..33
GL32-DWLN-22032-06JET	02994330	GL32	32,0	1.260	22,0	0.866	1.260	40,0	1.575	200,0	2900.8	95,0	-5,0	-12,0	0,2	0.440	WN..0604.. WN..33
GL40-DWLNR-27032-06JET	02994349	GL40	40,0	1.575	27,0	1.063	1.260	50,0	1.969	200,0	2900.8	95,0	-5,0	-12,0	0,2	0.440	WN..0604.. WN..33
GL40-DWLN-27032-06JET	02994347	GL40	40,0	1.575	27,0	1.063	1.260	50,0	1.969	200,0	2900.8	95,0	-5,0	-12,0	0,2	0.440	WN..0604.. WN..33
GL50-DWLNR-32032-06JET	02994361	GL50	50,0	1.969	32,0	1.260	1.260	63,0	2.480	200,0	2900.8	95,0	-5,0	-12,0	0,3	0.660	WN..0604.. WN..33
GL50-DWLN-32032-06JET	02994359	GL50	50,0	1.969	32,0	1.260	1.260	63,0	2.480	200,0	2900.8	95,0	-5,0	-12,0	0,3	0.660	WN..0604.. WN..33

Spare Parts

For size	Clamp screw	Coolant kit	Coolant seal	Insert shim	Key (T-handle)	O-ring	Shim/clamp key	Shim screw	Spring
GL32	L84017-T09P	CN14U00S-2-SET	930RD13	DWN060310	DOUBLE-T	O-RING-5.0X1.2	H4B-T09P	C03007-T09P	S5608
GL40	L84017-T09P	CN14U00S-2-SET	930RD13	DWN060310	DOUBLE-T	O-RING-5.0X1.2	H4B-T09P	C03007-T09P	S5608
GL50	L84017-T09P	CN14U00S-2-SET	930RD13	DWN060310	DOUBLE-T	O-RING-5.0X1.2	H4B-T09P	C03007-T09P	S5608

Accessories

For size	Insert clamping torque	Replacement blade	Torque key
GL32	2.0NM	T00-09P	T00-09P20
GL40	2.0NM	T00-09P	T00-09P20
GL50	2.0NM	T00-09P	T00-09P20

General ISO Turning

Steadyline®

MDT

Mini-Shaft™

Grooving

Parting-off

X4

Adapters
Clamping units

Accessories and
Spare parts

Workpiece
materials

General ISO Turning

Steadyline®

MDT

Mini-Shaft™

Grooving

Parting-off

X4

Adapters
Clamping units

Accessories and
Spare parts

Workpiece
materials

GL...DCLNR/L – Toolholders for inserts CNGG, CNMA, CNMG and CNMM – Metric / Inch

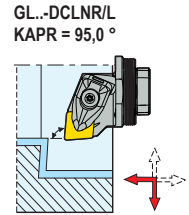
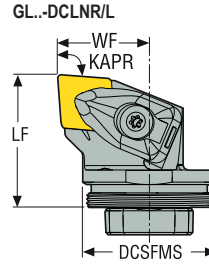
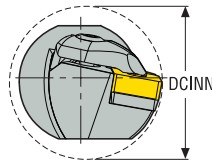

CTWS







- For inserts program, see page(s) 527, 528, 529, 530, 531, 532, 533
- GAMO° = Rake angle, LAMS° = Inclination angle
- CTMS = GL size
- CTWS = Insert shape and size
- For holder code key, see page(s) 19
- For damping holders program, see page(s) 607, 608-620
- Right-hand version shown
- Please check availability at www.secotools.com / Seco Online Store

Designation	Item number	CTMS	DCSFMS	WF	LF	DCINN	CP*	KAPR°	GAMO°	LAMS°	Weight	CTWS
			mm Inch	mm Inch	mm Inch	mm Inch	bar psi				kg lbs	
GL32-DCLNR-22032-12	02809539	GL32	32,0 1.260	22,0 0.866	32 1.260	40,0 1.575	–	95,0	-6,0	-10,0	0,2 0.440	CN..1204.. CN..43.
GL32-DCLNL-22032-12	02809540	GL32	32,0 1.260	22,0 0.866	32 1.260	40,0 1.575	–	95,0	-6,0	-10,0	0,2 0.440	CN..1204.. CN..43.
GL40-DCLNR-27032-12	02809477	GL40	40,0 1.575	27,0 1.063	32 1.260	50,0 1.969	–	95,0	-6,0	-10,0	0,2 0.440	CN..1204.. CN..43.
GL40-DCLNL-27032-12	02809478	GL40	40,0 1.575	27,0 1.063	32 1.260	50,0 1.969	–	95,0	-6,0	-10,0	0,2 0.440	CN..1204.. CN..43.
GL50-DCLNR-32032-12	02809517	GL50	50,0 1.969	32,0 1.260	32 1.260	63,0 2.480	–	95,0	-6,0	-8,0	0,3 0.660	CN..1204.. CN..43.
GL50-DCLNL-32032-12	02809518	GL50	50,0 1.969	32,0 1.260	32 1.260	63,0 2.480	–	95,0	-6,0	-8,0	0,3 0.660	CN..1204.. CN..43.
GL50-DCLNR-32037-16	02809519	GL50	50,0 1.969	32,0 1.260	37 1.457	63,0 2.480	–	95,0	-5,0	-14,0	0,4 0.880	CN..1606.. CN..54.
GL50-DCLNL-32037-16	02809520	GL50	50,0 1.969	32,0 1.260	37 1.457	63,0 2.480	–	95,0	-5,0	-14,0	0,4 0.880	CN..1606.. CN..54.
GL50-DCLNR-32040-19	02809521	GL50	50,0 1.969	32,0 1.260	40 1.575	63,0 2.480	–	95,0	-5,0	-14,0	0,4 0.880	CN..1906.. CN..64.
GL50-DCLNL-32040-19	02809522	GL50	50,0 1.969	32,0 1.260	40 1.575	63,0 2.480	–	95,0	-5,0	-14,0	0,4 0.880	CN..1906.. CN..64.

Spare Parts

For size	Clamp pin	Clamp screw	Floating wedge clamp	Insert shim	Key (T-handle)	Shim/clamp key	Shim screw	Spring
...12	FP2012	L85021-T15P	CD12-S	DCO120310	DOUBLE-T	H4B-T15P	C04008-T15P	S6912
...16	FP2012	L86026-T20P	CD16-S	DCN160616	DOUBLE-T	H6B-T20P	C05010-T20P	S7010
...19	FP2012	L86026-T20P	CD19-S	DCN190416	DOUBLE-T	H6B-T20P	C05010-T20P	S7010

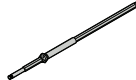
Accessories

For size	Clamp kit	Insert clamping torque	Replacement blade	Torque key
..-12	 CD12-S12	 3.5NM	 T00-15P	 T00-15P35
..-16	CD16-S16	6.0NM	T00T-20P	T00T-20P60
..-19	CD19-S19	6.0NM	T00T-20P	T00T-20P60

- General / ISO Turning
- Steadyline®
- MDT
- Mini-Shaft™
- Grooving
- Parting-off
- X4
- Adapters
Clamping units
- Accessories and
Spare parts
- Workpiece
materials

General ISO Turning

GL..-DDUNR/L – Toolholders for inserts DNGG, DNGM, DNMA, DNMG, DNMM, DNMU and DNMX – Metric/ Inch

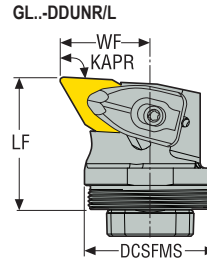
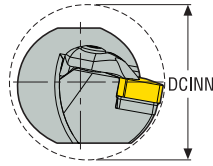

GL..-DDUNR/L
KAPR = 93,0 °

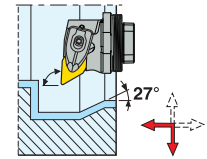

Steadyline®

MDT

CTWS



- For inserts program, see page(s) 537, 538, 539, 540, 541, 580, 598
- GAMO° = Rake angle, LAMS° = Inclination angle
- CTMS = GL size
- CTWS = Insert shape and size
- For holder code key, see page(s) 19
- For damping holders program, see page(s) 607, 608-620
- Right-hand version shown
- Please check availability at www.secotools.com / Seco Online Store

Mini-Shaft™

Grooving

Parting-off

X4

Adapters
Clamping units

Designation	Item number	CTMS	DCSFMS	WF	LF	DCINN	CP*	KAPR°	GAMO°	LAMS°	Weight	CTWS
			mm Inch	mm Inch	mm Inch	mm Inch	bar psi				kg lbs	
GL32-DDUNR-22032-11	02809541	GL32	32,0 1.260	22,0 0.866	32 1.260	40,0 1.575	–	93,0	-6,0	-10,0	0,2 0.440	DN..1104.. DN..33
GL32-DDUNL-22032-11	02809542	GL32	32,0 1.260	22,0 0.866	32 1.260	40,0 1.575	–	93,0	-6,0	-10,0	0,2 0.440	DN..1104.. DN..33
GL40-DDUNR-27032-11	02809479	GL40	40,0 1.575	27,0 1.063	32 1.260	50,0 1.969	–	93,0	-5,0	-10,0	0,2 0.440	DN..1104.. DN..33
GL40-DDUNL-27032-11	02809480	GL40	40,0 1.575	27,0 1.063	32 1.260	50,0 1.969	–	93,0	-5,0	-10,0	0,2 0.440	DN..1104.. DN..33
GL32-DDUNR-22032-15	02975022	GL32	32,0 1.260	21,88 0.861	32 1.260	40,0 1.575	–	93,0	-6,0	-14,0	0,2 0.440	DN.1504 DN..1506-DN..43 DN..44*
GL32-DDUNL-22032-15	02975023	GL32	32,0 1.260	21,88 0.861	32 1.260	40,0 1.575	–	93,0	-6,0	-14,0	0,2 0.440	DN.1504 DN..1506-DN..43 DN..44*
GL40-DDUNR-27032-15	02809481	GL40	40,0 1.575	27,0 1.063	32 1.260	50,0 1.969	–	93,0	-6,0	-12,0	0,2 0.440	DN.1504 DN..1506-DN..43 DN..44*
GL40-DDUNL-27032-15	02809482	GL40	40,0 1.575	27,0 1.063	32 1.260	50,0 1.969	–	93,0	-6,0	-12,0	0,2 0.440	DN.1504 DN..1506-DN..43 DN..44*
GL50-DDUNR-32032-15	02809523	GL50	50,0 1.969	32,0 1.260	32 1.260	63,0 2.480	–	93,0	-6,0	-12,0	0,3 0.660	DN.1504 DN..1506-DN..43 DN..44*
GL50-DDUNL-32032-15	02809524	GL50	50,0 1.969	32,0 1.260	32 1.260	63,0 2.480	–	93,0	-6,0	-12,0	0,3 0.660	DN.1504 DN..1506-DN..43 DN..44*









Spare Parts

For size	Clamp pin	Clamp screw	Floating wedge clamp	Insert shim	Key (T-handle)	Shim/clamp key	Shim screw	Spring
..11	FP1508	L84017-T09P	CD09-S	DDN110310	DOUBLE-T	H4B-T09P	C03007-T09P	S5608
..15	FP2012	L85021-T15P	CD12-S	DDN150416	DOUBLE-T	H4B-T15P	C04008-T15P	S6912

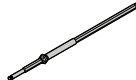
Accessories and
Spare parts

Workpiece
materials

Accessories

For size	Clamp kit	Insert clamping torque	Replacement blade	Torque key
..-11	 CD09-S09	 2.0NM	 T00-09P	 T00-09P20
..-15	 CD12-S12	 3.5NM	 T00-15P	 T00-15P35

- General / ISO Turning
- Steadyline®
- MDT
- Mini-Shaft™
- Grooving
- Parting-off
- X4
- Adapters
Clamping units
- Accessories and
Spare parts
- Workpiece
materials

General ISO Turning

Steadyline®

MDT

Mini-Shaft™

Grooving

Parting-off

X4

Adapters
Clamping units

Accessories and
Spare parts

Workpiece
materials

GL..-DWLNR/L – Toolholders for inserts WNGA, WNGG, WNMA, WNMG and WNMM – Metric/ Inch

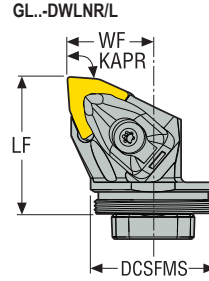
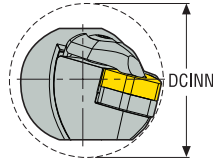

GL..-DWLNR/L
KAPR = 95,0 °

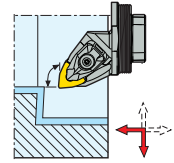

CTWS











- For inserts program, see page(s) 568, 569, 570, 571, 596
- GAMO° = Rake angle, LAMS° = Inclination angle
- CTMS = GL size
- CTWS = Insert shape and size
- For holder code key, see page(s) 19
- For damping holders program, see page(s) 607, 608-620
- Right-hand version shown
- Please check availability at www.secotools.com / Seco Online Store

Designation	Item number	CTMS	DCSFMS	WF	LF	DCINN	CP*	KAPR°	GAMO°	LAMS°	Weight	CTWS
			mm Inch	mm Inch	mm Inch	mm Inch	bar psi				kg lbs	
GL32-DWLNR-22032-06	02809543	GL32	32,0 1.260	22,0 0.866	32 1.260	40,0 1.575	–	95,0	-5,0	-12,0	0,2 0.440	WN..0604.. WN..33.
GL32-DWLNL-22032-06	02809544	GL32	32,0 1.260	22,0 0.866	32 1.260	40,0 1.575	–	95,0	-5,0	-12,0	0,2 0.440	WN..0604.. WN..33.
GL32-DWLNR-22035-08	02809545	GL32	32,0 1.260	22,0 0.866	35 1.378	40,0 1.575	–	95,0	-5,0	-14,0	0,2 0.440	WN..0804 WN..0806-WN..43 WN..44*
GL32-DWLNL-22035-08	02809546	GL32	32,0 1.260	22,0 0.866	35 1.378	40,0 1.575	–	95,0	-5,0	-14,0	0,2 0.440	WN..0804 WN..0806-WN..43 WN..44*
GL40-DWLNR-27032-06	02809483	GL40	40,0 1.575	27,0 1.063	32 1.260	50,0 1.969	–	95,0	-5,0	-12,0	0,2 0.440	WN..0604.. WN..33.
GL40-DWLNL-27032-06	02809484	GL40	40,0 1.575	27,0 1.063	32 1.260	50,0 1.969	–	95,0	-5,0	-12,0	0,2 0.440	WN..0604.. WN..33.
GL40-DWLNR-27037-08	02809485	GL40	40,0 1.575	27,0 1.063	37 1.457	50,0 1.969	–	95,0	-5,0	-12,0	0,2 0.440	WN..0804 WN..0806-WN..43 WN..44*
GL40-DWLNL-27037-08	02809486	GL40	40,0 1.575	27,0 1.063	37 1.457	50,0 1.969	–	95,0	-5,0	-12,0	0,2 0.440	WN..0804 WN..0806-WN..43 WN..44*
GL50-DWLNL-32032-06	02809526	GL50	50,0 1.969	32,0 1.260	32 1.260	63,0 2.480	–	95,0	-5,0	-12,0	0,3 0.660	WN..0604.. WN..33.
GL50-DWLNR-32038-08	02809527	GL50	50,0 1.969	32,0 1.260	38 1.496	63,0 2.480	–	95,0	-5,0	-12,0	0,3 0.660	WN..0804 WN..0806-WN..43 WN..44*
GL50-DWLNL-32038-08	02809528	GL50	50,0 1.969	32,0 1.260	38 1.496	63,0 2.480	–	95,0	-5,0	-12,0	0,3 0.660	WN..0804 WN..0806-WN..43 WN..44*

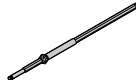
Spare Parts

For size	Clamp pin	Clamp screw	Floating wedge clamp	Insert shim	Key (T-handle)	Shim/clamp key	Shim screw	Spring
..06	FP1508	L84017-T09P	CD09-S	DWN060310	DOUBLE-T	H4B-T09P	C03007-T09P	S5608
..08	FP2012	L85021-T15P	CD12-S	DWN080416	DOUBLE-T	H4B-T15P	C04008-T15P	S6912

Accessories

For size	Clamp kit	Insert clamping torque	Replacement blade	Torque key
..-06	 CD09-S09	 2.0NM	 T00-09P	 T00-09P20
..-08	 CD12-S12	 3.5NM	 T00-15P	 T00-15P35

- General ISO Turning
- Steadyline®
- MDT
- Mini-Shaft™
- Grooving
- Parting-off
- X4
- Adapters Clamping units
- Accessories and Spare parts
- Workpiece materials

GL..-SCLCR/L – Toolholders for inserts CCGT, CCGW, CCGX, CCMT and CCMW – Metric/ Inch

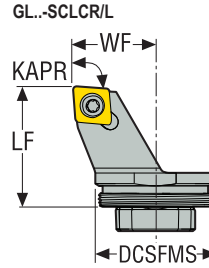
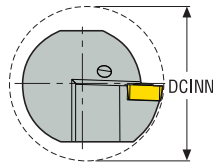

GL..-SCLCR/L
KAPR = 95,0 °

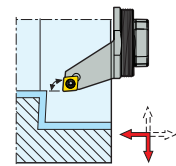

CTWS



- For inserts program, see page(s) 522, 523, 524, 525, 573, 574, 597, 599
- GAMO° = Rake angle, LAMS° = Inclination angle
- CTMS = GL size
- CTWS = Insert shape and size
- For holder code key, see page(s) 19
- For damping holders program, see page(s) 607, 608-620
- Right-hand version shown
- Please check availability at www.secotools.com / Seco Online Store

Designation	Item number	CTMS	DCSFMS	WF	LF	DCINN	CP*	KAPR°	GAMO°	LAMS°	Weight	CTWS
			mm <i>Inch</i>	mm <i>Inch</i>	mm <i>Inch</i>	mm <i>Inch</i>	bar <i>psi</i>				kg <i>lbs</i>	
GL25-SCLCR-17020-09	03211318	GL25	25,0 0.984	17,0 0.669	20 0.787	32,0 1.260	–	95,0	0,0	-3,0	0,3 0.660	CC..09T3.. CC..32.5.
GL25-SCLCL-17020-09	03211319	GL25	25,0 0.984	17,0 0.669	20 0.787	32,0 1.260	–	95,0	0,0	-3,0	0,5 1.100	CC..09T3.. CC..32.5.

Spare Parts

For size	Insert key	Insert screw	Key (T-handle)
-09	 H4B-T15P	 C04008-T15P	 DOUBLE-T

Accessories

For size	Insert clamping torque	Replacement blade	Torque key
-09	 3.5NM	 T00-15P	 T00-15P35

GL..-SCLCR/L – Toolholders for inserts CCGT, CCGW, CCGX and CCMT – Metric / Inch

GL..-SCLCR/L
KAPR = 95,0°

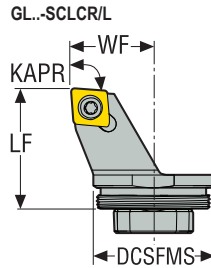
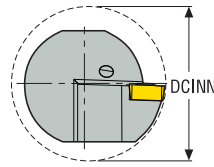
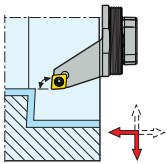





- For inserts program, see page(s) 522, 523, 524, 525, 573, 574, 597
- GAMO° = Rake angle, LAMS° = Inclination angle
- CTMS = GL size
- CTWS = Insert shape and size
- For holder code key, see page(s) 19
- For damping holders program, see page(s) 607, 608-620
- Right-hand version shown
- Please check availability at www.secotools.com / Seco Online Store



Designation	Item number	CTMS	DCSFMS	WF	LF	DCINN	CP*	KAPR°	GAMO°	LAMS°	Weight	CTWS
			mm Inch	mm Inch	mm Inch	mm Inch						
GL32-SCLCR-22032-09	02809490	GL32	32,0 1.260	22,0 0.866	32 1.260	40,0 1.575	-	95,0	0,0	-2,0	0,1 0.220	CC..09T3.. CC..32.5.
GL32-SCLCL-22032-09	02809491	GL32	32,0 1.260	22,0 0.866	32 1.260	40,0 1.575	-	95,0	0,0	-2,0	0,1 0.220	CC..09T3.. CC..32.5.
GL32-SCLCR-22032-12	02809492	GL32	32,0 1.260	22,0 0.866	32 1.260	40,0 1.575	-	95,0	0,0	-8,0	0,1 0.220	CC..1204.. CC..43.
GL32-SCLCL-22032-12	02809493	GL32	32,0 1.260	22,0 0.866	32 1.260	40,0 1.575	-	95,0	0,0	-8,0	0,1 0.220	CC..1204.. CC..43.
GL40-SCLCR-27032-06	02809487	GL40	40,0 1.575	27,0 1.063	32 1.260	50,0 1.969	-	95,0	0,0	-2,0	0,2 0.440	CC..0602.. CC..21.5.
GL40-SCLCL-27032-06	02809502	GL40	40,0 1.575	27,0 1.063	32 1.260	50,0 1.969	-	95,0	0,0	-2,0	0,2 0.440	CC..0602.. CC..21.5.
GL40-SCLCR-27032-09	02809503	GL40	40,0 1.575	27,0 1.063	32 1.260	50,0 1.969	-	95,0	0,0	-2,0	0,2 0.440	CC..09T3.. CC..32.5.
GL40-SCLCL-27032-09	02809504	GL40	40,0 1.575	27,0 1.063	32 1.260	50,0 1.969	-	95,0	0,0	-2,0	0,2 0.440	CC..09T3.. CC..32.5.
GL40-SCLCR-27032-12	02809505	GL40	40,0 1.575	27,0 1.063	32 1.260	50,0 1.969	-	95,0	0,0	-8,0	0,2 0.440	CC..1204.. CC..43.
GL40-SCLCL-27032-12	02809506	GL40	40,0 1.575	27,0 1.063	32 1.260	50,0 1.969	-	95,0	0,0	-8,0	0,2 0.440	CC..1204.. CC..43.
GL50-SCLCR-32032-06	02809529	GL50	50,0 1.969	32,0 1.260	32 1.260	63,0 2.480	-	95,0	0,0	-2,0	0,3 0.660	CC..0602.. CC..21.5.
GL50-SCLCL-32032-06	02809530	GL50	50,0 1.969	32,0 1.260	32 1.260	63,0 2.480	-	95,0	0,0	-2,0	0,3 0.660	CC..0602.. CC..21.5.
GL50-SCLCR-32032-09	02809531	GL50	50,0 1.969	32,0 1.260	32 1.260	63,0 2.480	-	95,0	0,0	-2,0	0,3 0.660	CC..09T3.. CC..32.5.
GL50-SCLCL-32032-09	02809532	GL50	50,0 1.969	32,0 1.260	32 1.260	63,0 2.480	-	95,0	0,0	-2,0	0,3 0.660	CC..09T3.. CC..32.5.
GL50-SCLCR-32032-12	02809533	GL50	50,0 1.969	32,0 1.260	32 1.260	63,0 2.480	-	95,0	0,0	-5,0	0,3 0.660	CC..1204.. CC..43.
GL50-SCLCL-32032-12	02809534	GL50	50,0 1.969	32,0 1.260	32 1.260	63,0 2.480	-	95,0	0,0	-5,0	0,3 0.660	CC..1204.. CC..43.

General ISO Turning
Steadyline®
MDT
Mini-Shaft™
Grooving
Parting-off
X4
Adapters
Clamping units
Accessories and Spare parts
Workpiece materials

Spare Parts

For size	Insert key	Insert screw	Insert shim	Key (T-handle)	Shim screw
...09	 H4B-T15P	 C04008-T15P	 -	 DOUBLE-T	 -
...12	H4B-T15P	C05012-T15P	123.19-621	DOUBLE-T	CA5008
...06	H4B-T07P	C02506-T07P	-	DOUBLE-T	-

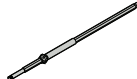
Accessories

For size	Insert clamping torque	Replacement blade	Shim key	Torque key
...09	 3.5NM	 T00-15P	 -	 T00-15P35
...12	5.0NM	T00-15P	5SMS795	T00-15P50
...06	0.9NM	T00-07P	-	T00-07P09

General ISO Turning

Steadyline®

MDT

Mini-Shaft™

Grooving

Parting-off

X4

Adapters
Clamping units

Accessories and
Spare parts

Workpiece
materials

GL...SDUCR/L – Toolholders for inserts DCGT, DCGW, DCMT, DCMW and DCMX – Metric/ Inch

GL...SDUCR/L
KAPR = 93,0°

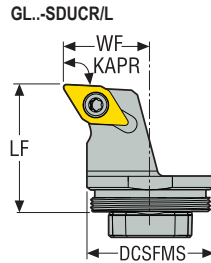
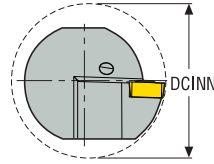
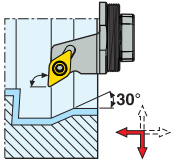

- For inserts program, see page(s) 534, 535, 536, 578, 600
- GAMO° = Rake angle, LAMS° = Inclination angle
- CTMS = GL size
- CTWS = Insert shape and size
- For holder code key, see page(s) 19
- For damping holders program, see page(s) 607, 608-620
- Right-hand version shown
- Please check availability at www.secotools.com / Seco Online Store

Designation	Item number	CTMS	DCSFMS	WF	LF	DCINN	CP*	KAPR°	GAMO°	LAMS°	Weight	CTWS
			mm Inch	mm Inch	mm Inch	mm Inch	bar psi				kg lbs	
GL25-SDUCR-17020-07	03211320	GL25	25,0 0.984	17,0 0.669	20 0.787	32,0 1.260	-	93,0	0,0	-6,0	0,3 0.660	DC..0702.. DC..21.5..
GL25-SDUCL-17020-07	03211321	GL25	25,0 0.984	17,0 0.669	20 0.787	32,0 1.260	-	93,0	0,0	-6,0	0,3 0.660	DC..0702.. DC..21.5..
GL25-SDUCR-17020-11	03211322	GL25	25,0 0.984	17,0 0.669	20 0.787	32,0 1.260	-	93,0	0,0	-6,0	0,3 0.660	DC..11T3.. DC..32.5.
GL25-SDUCL-17020-11	03211323	GL25	25,0 0.984	17,0 0.669	20 0.787	32,0 1.260	-	93,0	0,0	-6,0	0,3 0.660	DC..11T3.. DC..32.5.

Spare Parts

For size	Insert key	Insert screw	Key (T-handle)
-07	H4B-T07P	C02506-T07P	DOUBLE-T
-11	H4B-T15P	C04008-T15P	DOUBLE-T

Accessories

For size	Insert clamping torque	Replacement blade	Torque key
-07	0.9NM	T00-07P	T00-07P09
-11	3.5NM	T00-15P	T00-15P35

General ISO Turning

Steadyline®

MDT

Mini-Shaft™

Grooving

Parting-off

X4

Adapters
Clamping units

Accessories and
Spare parts

Workpiece
materials

General ISO Turning

GL..-SDUCR/L – Toolholders for inserts DCGT, DCGW, DCMT and DCMX – Metric/ Inch

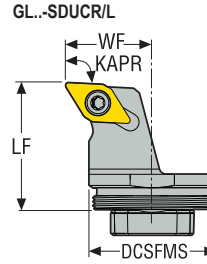
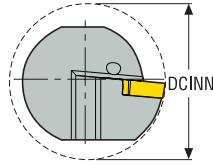

GL..-SDUCR/L
KAPR = 93,0 °

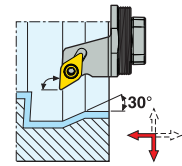

Steadyline®

CTWS



MDT

- For inserts program, see page(s) 534, 535, 536, 578
- GAMO° = Rake angle, LAMS° = Inclination angle
- CTMS = GL size
- CTWS = Insert shape and size
- For holder code key, see page(s) 19
- For damping holders program, see page(s) 607, 608-620
- Right-hand version shown
- Please check availability at www.secotools.com / Seco Online Store

Mini-Shaft™

Designation	Item number	CTMS	DCSFMS	WF	LF	DCINN	CP*	KAPR°	GAMO°	LAMS°	Weight	CTWS
			mm <i>Inch</i>	mm <i>Inch</i>	mm <i>Inch</i>	mm <i>Inch</i>	bar <i>psi</i>				kg <i>lbs</i>	
GL32-SDUCR-22032-11	02809494	GL32	32,0 1.260	22,0 0.866	32 1.260	40,0 1.575	–	93,0	0,0	-5,0	0,1 0.220	DC..11T3.. DC..32.5.
GL32-SDUCL-22032-11	02809495	GL32	32,0 1.260	22,0 0.866	32 1.260	40,0 1.575	–	93,0	0,0	-5,0	0,1 0.220	DC..11T3.. DC..32.5.
GL40-SDUCR-27032-11	02809507	GL40	40,0 1.575	27,0 1.063	32 1.260	50,0 1.969	–	93,0	0,0	-5,0	0,2 0.440	DC..11T3.. DC..32.5.
GL40-SDUCL-27032-11	02809508	GL40	40,0 1.575	27,0 1.063	32 1.260	50,0 1.969	–	93,0	0,0	-5,0	0,2 0.440	DC..11T3.. DC..32.5.
GL50-SDUCR-32032-11	02809535	GL50	50,0 1.969	32,0 1.260	32 1.260	63,0 2.480	–	93,0	0,0	-5,0	0,3 0.660	DC..11T3.. DC..32.5.
GL50-SDUCL-32032-11	02809536	GL50	50,0 1.969	32,0 1.260	32 1.260	63,0 2.480	–	93,0	0,0	-5,0	0,3 0.660	DC..11T3.. DC..32.5.

Grooving

Parting-off

Spare Parts

X4

For size	Insert key	Insert screw	Key (T-handle)
..-11	 H4B-T15P	 C04008-T15P	 DOUBLE-T

Adapters
Clamping units

Accessories

Accessories and
Spare parts

For size	Insert clamping torque	Replacement blade	Torque key
..-11	 3.5NM	 T00-15P	 T00-15P35

Workpiece
materials

GL...SDUCR/L...X – Toolholders for inserts DCGT, DCGW, DCMT, DCMW and DCMX – Metric/ Inch

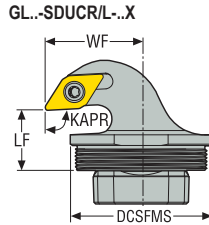
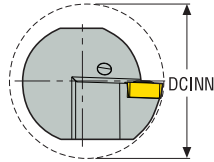
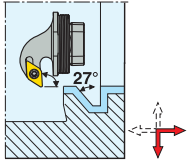

GL...SDUCR/L...X
KAPR = 93,0°





- For inserts program, see page(s) 534, 535, 536, 578, 600
- GAMO° = Rake angle, LAMS° = Inclination angle
- CTMS = GL size
- CTWS = Insert shape and size
- For holder code key, see page(s) 19
- For damping holders program, see page(s) 607, 608-620
- Right-hand version shown
- Please check availability at www.secotools.com / Seco Online Store

Designation	Item number	CTMS	DCSFMS	WF	LF	DCINN	CP*	KAPR°	GAMO°	LAMS°	Weight	CTWS
			mm Inch	mm Inch	mm Inch	mm Inch	bar psi				kg lbs	
GL25-SDUCR-17012-11X	03211326	GL25	25,0 0.984	17,0 0.669	12 0.472	32,0 1.260	-	93,0	0,0	-6,0	0,2 0.440	DC..11T3.. DC..32.5.
GL25-SDUCL-17012-11X	03211327	GL25	25,0 0.984	17,0 0.669	12 0.472	32,0 1.260	-	93,0	0,0	-6,0	0,2 0.440	DC..11T3.. DC..32.5.

Spare Parts

For size	Insert key	Insert screw	Key (T-handle)
-11X	 H4B-T15P	 C04008-T15P	 DOUBLE-T

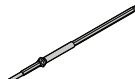
Accessories

For size	Insert clamping torque	Replacement blade	Torque key
-11X	 3.5NM	 T00-15P	 T00-15P35

General / ISO Turning

Steadyline®

MDT

Mini-Shaft™

Grooving

Parting-off

X4

Adapters
Clamping units

Accessories and
Spare parts

Workpiece
materials

General ISO Turning

GL..-SDUCR/L-..X – Toolholders for inserts DCGT, DCGW, DCMT, DCMW and DCMX – Metric/ Inch

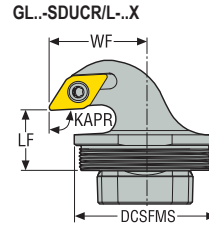
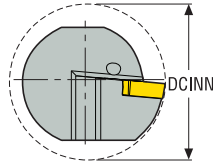

GL..-SDUCR/L-..X
KAPR = 93,0 °

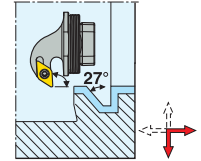

Steadyline®

MDT

CTWS



- For inserts program, see page(s) 534, 535, 536, 578, 600
- GAMO° = Rake angle, LAMS° = Inclination angle
- CTMS = GL size
- CTWS = Insert shape and size
- For holder code key, see page(s) 19
- For damping holders program, see page(s) 607, 608-620
- Right-hand version shown
- Please check availability at www.secotools.com / Seco Online Store

Mini-Shaft™



Grooving

Parting-off

Designation	Item number	CTMS	DCSFMS	WF	LF	DCINN	CP*	KAPR°	GAMO°	LAMS°	Weight	CTWS
			mm <i>Inch</i>	mm <i>Inch</i>	mm <i>Inch</i>	mm <i>Inch</i>	bar <i>psi</i>				kg <i>lbs</i>	
GL32-SDUCR-22018-11X	02975005	GL32	32,0 1.260	21,88 0.861	18 0.709	40,0 1.575	–	93,0	0,0	-5,0	0,2 0.440	DC..11T3.. DC..32.5.
GL32-SDUCL-22018-11X	02975006	GL32	32,0 1.260	21,88 0.861	18 0.709	40,0 1.575	–	93,0	0,0	-5,0	0,2 0.440	DC..11T3.. DC..32.5.
GL40-SDUCR-27017-11X	02975007	GL40	40,0 1.575	26,88 1.058	17 0.669	50,0 1.969	–	93,0	0,0	-5,0	0,2 0.440	DC..11T3.. DC..32.5.
GL40-SDUCL-27017-11X	02975008	GL40	40,0 1.575	26,88 1.058	17 0.669	50,0 1.969	–	93,0	0,0	-5,0	0,2 0.440	DC..11T3.. DC..32.5.
GL50-SDUCR-32017-11X	02975009	GL50	50,0 1.969	32,0 1.260	17 0.669	63,0 2.480	–	93,0	0,0	-5,0	0,3 0.660	DC..11T3.. DC..32.5.
GL50-SDUCL-32017-11X	02975010	GL50	50,0 1.969	32,0 1.260	17 0.669	63,0 2.480	–	93,0	0,0	-5,0	0,3 0.660	DC..11T3.. DC..32.5.



Spare Parts

X4

For size	Insert key	Insert screw	Key (T-handle)
..-11	 H4B-T15P	 C04008-T15P	 DOUBLE-T

Adapters
Clamping units

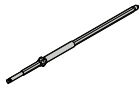
Accessories

For size	Insert clamping torque	Replacement blade	Torque key
..-11	 3.5NM	 T00-15P	 T00-15P35

Accessories and
Spare parts

Workpiece
materials

GL..-SDUNR/L – Toolholders for inserts DNMA, DNMU and DNMX – Metric/ Inch

GL..-SDUNR/L
KAPR = 93,0°

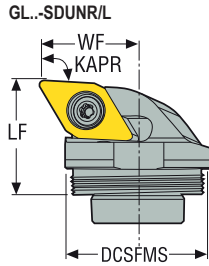
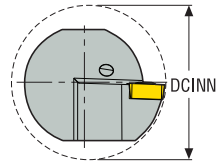
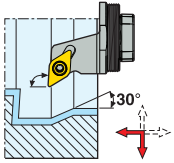

CTWS



- For inserts program, see page(s) 537, 538, 539, 540, 541, 580
- GAMO° = Rake angle, LAMS° = Inclination angle
- CTMS = GL size
- CTWS = Insert shape and size For holder code key, see page(s) 19
- For damping holders program, see page(s) 607, 608-620
- Right-hand version shown
- Please check availability at www.secotools.com / Seco Online Store

Designation	Item number	CTMS	DCSFMS		WF	LF	DCINN	CP*	KAPR°	GAMO°	LAMS°	Weight	CTWS				
			mm	Inch	mm	Inch								mm	Inch	bar	psi
GL25-SDUNR-17020-11	03211316	GL25	25,0	0.984	17,0	0.669	20	0.787	32,0	1.260	-	93,0	-5,0	-13,0	0,3	0.660	DN..1104.. DN..33.
GL25-SDUNL-17020-11	03211317	GL25	25,0	0.984	17,0	0.669	20	0.787	32,0	1.260	-	93,0	-5,0	-13,0	0,3	0.660	DN..1104.. DN..33.

Spare Parts

For size	Insert key	Insert screw	Key (T-handle)
-11	 H4B-T09P	 C03511-T09P	 DOUBLE-T

Accessories

For size	Insert clamping torque	Replacement blade	Torque key
-11	 2.0NM	 T00-09P	 T00-09P20

General ISO Turning

Steadyline®

MDT

Mini-Shaft™

Grooving

Parting-off

X4

Adapters
Clamping units

Accessories and
Spare parts

Workpiece
materials

General ISO Turning

GL..-SDUNR/L..X – Toolholders for inserts DNMU and DNMX – Metric/ Inch

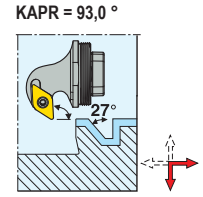
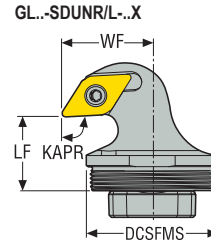
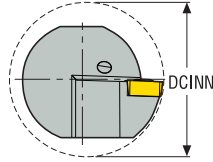

Steadyline®

CTWS



MDT

- For inserts program, see page(s) 537, 538, 539, 540, 541
- GAMO° = Rake angle, LAMS° = Inclination angle
- CTMS = GL size
- CTWS = Insert shape and size For holder code key, see page(s) 19
- For damping holders program, see page(s) 607, 608-620
- Right-hand version shown
- Please check availability at www.secotools.com / Seco Online Store

Mini-Shaft™

Designation	Item number	CTMS	DCSFMS		WF	LF	DCINN	CP*	KAPR°	GAMO°	LAMS°	Weight		CTWS			
			mm	Inch								kg	lbs				
GL32-SDUNR-22018-11X	02975003	GL32	32,0	1.260	21,88	0.861	18	0.709	40,0	1.575	-	93,0	-6,0	-10,0	0,2	0.440	DN..1104..
GL32-SDUNL-22018-11X	02975004	GL32	32,0	1.260	21,88	0.861	18	0.709	40,0	1.575	-	93,0	-6,0	-10,0	0,2	0.440	DN..1104..

Grooving

Spare Parts

Parting-off

For size	Insert key	Insert screw	Key (T-handle)
	H4B-T09P	C03511-T09P	DOUBLE-T

X4

Accessories

For size	Insert clamping torque	Replacement blade	Torque key
	2.0NM	T00-09P	T00-09P20

Adapters Clamping units

Accessories and Spare parts

Workpiece materials

GL..-SDXCR/L – Toolholders for inserts DCGT, DCGW, DCMT, DCMW and DCMX – Metric/ Inch

GL..-SDXCR/L
KAPR = 62,5°

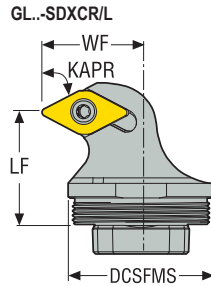
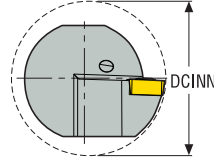
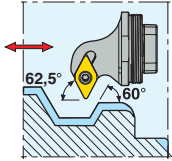

- For inserts program, see page(s) 534, 535, 536, 578, 600
- GAMO° = Rake angle, LAMS° = Inclination angle
- CTMS = GL size
- CTWS = Insert shape and size
- For holder code key, see page(s) 19
- For damping holders program, see page(s) 607, 608-620
- Right-hand version shown
- Please check availability at www.secotools.com / Seco Online Store

Designation	Item number	CTMS	DCSFMS	WF	LF	DCINN	CP*	KAPR°	GAMO°	LAMS°	Weight	CTWS
			mm Inch	mm Inch	mm Inch	mm Inch	bar psi				kg lbs	
GL25-SDXCR-17018-11	03211324	GL25	25,0 0.984	17,0 0.669	18 0.709	32,0 1.260	-	62,5	0,0	-6,0	0,2 0.440	DC..11T3.. DC..32.5.
GL25-SDXCL-17018-11	03211325	GL25	25,0 0.984	17,0 0.669	18 0.709	32,0 1.260	-	62,5	0,0	-6,0	0,3 0.660	DC..11T3.. DC..32.5.

Spare Parts

For size	Insert key	Insert screw	Key (T-handle)
-11	 H4B-T15P	 C04008-T15P	 DOUBLE-T

Accessories

For size	Insert clamping torque	Replacement blade	Torque key
-11	 3.5NM	 T00-15P	 T00-15P35

General ISO Turning

Steadyline®

MDT

Mini-Shaft™

Grooving

Parting-off

X4

Adapters
Clamping units

Accessories and
Spare parts

Workpiece
materials

General ISO Turning

GL..-SDXCR/L – Toolholders for inserts DCGT, DCGW, DCMT, DCMW and DCMX – Metric/ Inch

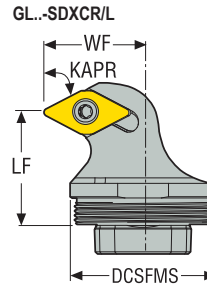
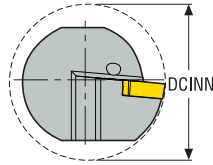

GL..-SDXCR/L
KAPR = 62,5 °

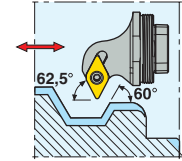

Steadyline®

CTWS



MDT

- For inserts program, see page(s) 534, 535, 536, 578, 600
- GAMO° = Rake angle, LAMS° = Inclination angle
- CTMS = GL size
- CTWS = Insert shape and size
- For holder code key, see page(s) 19
- For damping holders program, see page(s) 607, 608-620
- Right-hand version shown
- Please check availability at www.secotools.com / Seco Online Store

Mini-Shaft™



Designation	Item number	CTMS	DCSFMS	WF	LF	DCINN	CP*	KAPR°	GAMO°	LAMS°	Weight	CTWS
			mm <i>Inch</i>	mm <i>Inch</i>	mm <i>Inch</i>	mm <i>Inch</i>	bar <i>psi</i>				kg <i>lbs</i>	
GL32-SDXCR-22025-11	02975013	GL32	32,0 1.260	21,88 0.861	25 0.984	40,0 1.575	–	62,5	0,0	-5,0	0,2 0.440	DC..11T3.. DC..32.5.
GL32-SDXCL-22025-11	02975014	GL32	32,0 1.260	21,88 0.861	25 0.984	40,0 1.575	–	62,5	0,0	-5,0	0,2 0.440	DC..11T3.. DC..32.5.
GL40-SDXCR-27025-11	02975015	GL40	40,0 1.575	26,88 1.058	25 0.984	50,0 1.969	–	62,5	0,0	-5,0	0,2 0.440	DC..11T3.. DC..32.5.
GL40-SDXCL-27025-11	02975016	GL40	40,0 1.575	26,88 1.058	25 0.984	50,0 1.969	–	62,5	0,0	-5,0	0,2 0.440	DC..11T3.. DC..32.5.
GL50-SDXCR-32025-11	02975017	GL50	50,0 1.969	31,88 1.255	25 0.984	63,0 2.480	–	62,5	0,0	-5,0	0,3 0.660	DC..11T3.. DC..32.5.
GL50-SDXCL-32025-11	02975018	GL50	50,0 1.969	31,88 1.255	25 0.984	63,0 2.480	–	62,5	0,0	-5,0	0,3 0.660	DC..11T3.. DC..32.5.

Grooving

Parting-off

Spare Parts



X4

For size	Insert key	Insert screw	Key (T-handle)
..-11	 H4B-T15P	 C04008-T15P	 DOUBLE-T

Adapters
Clamping units

Accessories

Accessories and
Spare parts

For size	Insert clamping torque	Replacement blade	Torque key
..-11	 3.5NM	 T00-15P	 T00-15P35

Workpiece
materials

GL..-SDXNR/L – Toolholders for inserts DNMA, DNMU and DNMX – Metric/ Inch

KAPR = 62,5°

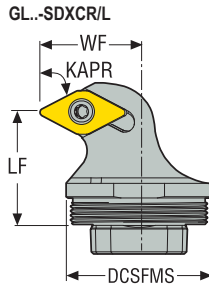
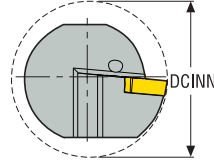
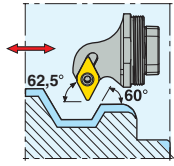

CTWS



- For inserts program, see page(s) 537, 538, 539, 540, 541, 580
- GAMO° = Rake angle, LAMS° = Inclination angle
- CTMS = GL size
- CTWS = Insert shape and size
- For holder code key, see page(s) 19
- For damping holders program, see page(s) 607, 608-620
- Right-hand version shown
- Please check availability at www.secotools.com / Seco Online Store

Designation	Item number	CTMS	DCSFMS	WF	LF	DCINN	CP*	KAPR°	GAMO°	LAMS°	Weight	CTWS
			mm Inch	mm Inch	mm Inch	mm Inch	bar psi				kg lbs	
GL32-SDXNR-22025-11	02975011	GL32	32,0 1.260	21,88 0.861	25 0.984	40,0 1.575	-	62,5	0,0	-10,0	0,2 0.440	DN..1104..
GL32-SDXNL-22025-11	02975012	GL32	32,0 1.260	21,88 0.861	25 0.984	40,0 1.575	-	62,5	0,0	-10,0	0,2 0.440	DN..1104..

Spare Parts

For size	Insert key	Insert screw	Key (T-handle)
	H4B-T09P	C03511-T09P	DOUBLE-T

Accessories

For size	Insert clamping torque	Replacement blade	Torque key
	2.0NM	T00-09P	T00-09P20

General / ISO Turning

Steadyline®

MDT

Mini-Shaft™

Grooving

Parting-off

X4

Adapters
Clamping units

Accessories and
Spare parts

Workpiece
materials

GL..-STFCR/L – Toolholders for inserts TCGT, TCGW, TCMT and TCMW – Metric/ Inch

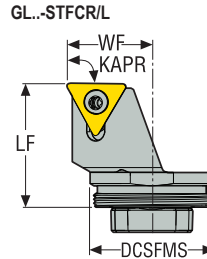
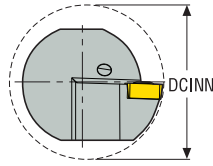

GL..-STFCR/L
KAPR = 90,0 °

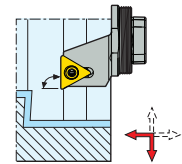

CTWS



- For inserts program, see page(s) 555, 556, 589, 601
- GAMO° = Rake angle, LAMS° = Inclination angle
- CTMS = GL size
- CTWS = Insert shape and size
- For holder code key, see page(s) 19
- For damping holders program, see page(s) 607, 608-620
- Right-hand version shown
- Please check availability at www.secotools.com / Seco Online Store

Designation	Item number	CTMS	DCSFMS	WF	LF	DCINN	CP*	KAPR°	GAMO°	LAMS°	Weight	CTWS
			mm <i>Inch</i>	mm <i>Inch</i>	mm <i>Inch</i>	mm <i>Inch</i>	bar <i>psi</i>				kg <i>lbs</i>	
GL25-STFCR-17020-11	03211328	GL25	25,0 0.984	17,0 0.669	20 0.787	32,0 1.260	–	90,0	0,0	-3,0	0,3 0.660	TC..1102.. TC..21.5
GL25-STFCL-17020-11	03211329	GL25	25,0 0.984	17,0 0.669	20 0.787	32,0 1.260	–	90,0	0,0	-3,0	0,3 0.660	TC..1102.. TC..21.5

Spare Parts

For size	Insert key	Insert screw	Key (T-handle)
-11	 H4B-T07P	 C02506-T07P	 DOUBLE-T

Accessories

For size	Insert clamping torque	Replacement blade	Torque key
-11	 0.9NM	 T00-07P	 T00-07P09

GL..-STFCR/L – Toolholders for inserts TCGT, TCGX, TCMT, TCMW and TCMX – Metric / Inch

GL..-STFCR/L
KAPR = 90,0°

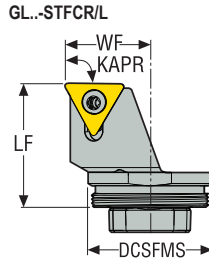
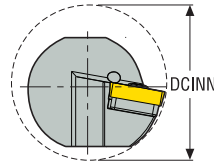
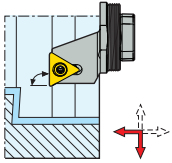

- For inserts program, see page(s) 555, 556, 592, 601
- GAMO° = Rake angle, LAMS° = Inclination angle
- CTMS = GL size
- CTWS = Insert shape and size
- For holder code key, see page(s) 19
- For damping holders program, see page(s) 607, 608-620
- Right-hand version shown
- Please check availability at www.secotools.com / Seco Online Store

Designation	Item number	CTMS	DCSFMS	WF	LF	DCINN	CP*	KAPR°	GAMO°	LAMS°	Weight	CTWS
			mm Inch	mm Inch	mm Inch	mm Inch	bar psi				kg lbs	
GL32-STFCR-22032-16	02809496	GL32	32,0 1.260	22,0 0.866	32 1.260	40,0 1.575	-	90,0	0,0	-10,0	0,2 0.440	TC..16T3.. TC..32.5
GL32-STFCL-22032-16	02809497	GL32	32,0 1.260	22,0 0.866	32 1.260	40,0 1.575	-	90,0	0,0	-10,0	0,2 0.440	TC..16T3.. TC..32.5
GL40-STFCR-27032-16	02809509	GL40	40,0 1.575	27,0 1.063	32 1.260	50,0 1.969	-	90,0	0,0	-8,0	0,2 0.440	TC..16T3.. TC..32.5
GL40-STFCL-27032-16	02809510	GL40	40,0 1.575	27,0 1.063	32 1.260	50,0 1.969	-	90,0	0,0	-8,0	0,2 0.440	TC..16T3.. TC..32.5
GL50-STFCR-32032-16	02809537	GL50	50,0 1.969	32,0 1.260	32 1.260	63,0 2.480	-	90,0	0,0	-8,0	0,3 0.660	TC..16T3.. TC..32.5
GL50-STFCL-32032-16	02809538	GL50	50,0 1.969	32,0 1.260	32 1.260	63,0 2.480	-	90,0	0,0	-8,0	0,3 0.660	TC..16T3.. TC..32.5

Spare Parts

For size	Insert key	Insert screw	Insert shim	Key (T-handle)	Shim screw
..-16	 H4B-T15P	 C03509-T15P	 STN160312	 DOUBLE-T	 CA3510

Accessories

For size	Insert clamping torque	Replacement blade	Shim key	Torque key
..-16	 3.0NM	 T00-15P	 9/64SMS875	 T00-15P30

General / ISO Turning

Steadyline®

MDT

Mini-Shaft™

Grooving

Parting-off

X4

Adapters
Clamping units

Accessories and
Spare parts

Workpiece
materials

GL..-SVUBR/L – Toolholders for inserts VBGT and VBMT – Metric/ Inch

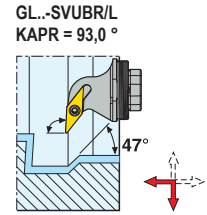
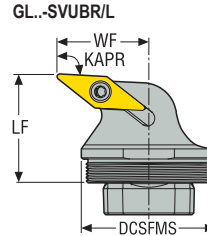
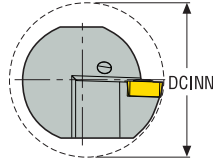

CTWS



- For inserts program, see page(s) 563, 564
- GAMO° = Rake angle, LAMS° = Inclination angle
- CTMS = GL size
- CTWS = Insert shape and size
- For holder code key, see page(s) 19
- For damping holders program, see page(s) 607, 608-620
- Right-hand version shown
- Please check availability at www.secotools.com / Seco Online Store

Designation	Item number	CTMS	DCSFMS	WF	LF	DCINN	CP*	KAPR°	GAMO°	LAMS°	Weight	CTWS
			mm <i>Inch</i>	mm <i>Inch</i>	mm <i>Inch</i>	mm <i>Inch</i>	bar <i>psi</i>				kg <i>lbs</i>	
GL25-SVUBR-17020-11	03211330	GL25	25,0 0.984	17,0 0.669	20 0.787	32,0 1.260	–	93,0	0,0	-4,0	0,3 0.660	VB..1102.. VB..21.5
GL25-SVUBL-17020-11	03211331	GL25	25,0 0.984	17,0 0.669	20 0.787	32,0 1.260	–	93,0	0,0	-4,0	0,3 0.660	VB..1102.. VB..21.5

Spare Parts

For size	Insert key	Insert screw	Key (T-handle)
-11	 H4B-T07P	 C02506-T07P	 DOUBLE-T

Accessories

For size	Insert clamping torque	Replacement blade	Torque key
-11	 0.9NM	 T00-07P	 T00-07P09

GL...SVUBR/L – Toolholders for inserts VBGT, VBGW, VBMT and VBW – Metric / Inch

GL...SVUBR/L
KAPR = 93,0°

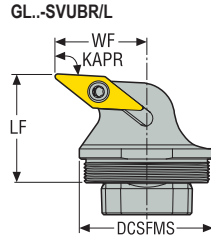
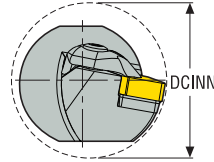
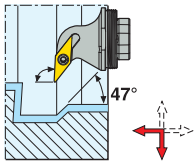

CTWS



- For inserts program, see page(s) 563, 564, 594, 602
- GAMO° = Rake angle, LAMS° = Inclination angle
- CTMS = GL size
- CTWS = Insert shape and size
- For holder code key, see page(s) 19
- For damping holders program, see page(s) 607, 608-620
- Right-hand version shown
- Please check availability at www.secotools.com / Seco Online Store

Designation	Item number	CTMS	DCSFMS	WF	LF	DCINN	CP*	KAPR°	GAMO°	LAMS°	Weight	CTWS
			mm Inch	mm Inch	mm Inch	mm Inch	bar psi				kg lbs	
GL32-SVUBR-22032-16	02974997	GL32	32,0 1.260	22,0 0.866	32 1.260	40,0 1.575	-	93,0	0,0	-3,0	0,2 0.440	VB.T1604.. VB.T33.
GL32-SVUBL-22032-16	02974998	GL32	32,0 1.260	22,0 0.866	32 1.260	40,0 1.575	-	93,0	0,0	-3,0	0,2 0.440	VB.T1604.. VB.T33.
GL40-SVUBR-27032-16	02974999	GL40	40,0 1.575	26,88 1.058	32 1.260	50,0 1.969	-	93,0	0,0	-3,0	0,2 0.440	VB.T1604.. VB.T33.
GL40-SVUBL-27032-16	02975000	GL40	40,0 1.575	26,88 1.058	32 1.260	50,0 1.969	-	93,0	0,0	-3,0	0,2 0.440	VB.T1604.. VB.T33.
GL50-SVUBR-32032-16	02975001	GL50	50,0 1.969	31,88 1.255	32 1.260	63,0 2.480	-	93,0	0,0	-3,0	0,3 0.660	VB.T1604.. VB.T33.
GL50-SVUBL-32032-16	02975002	GL50	50,0 1.969	31,88 1.255	32 1.260	63,0 2.480	-	93,0	0,0	-3,0	0,3 0.660	VB.T1604.. VB.T33.

Spare Parts

For size	Insert key	Insert screw	Insert shim	Key (T-handle)	Shim screw
..-16	 H4B-T15P	 C03510-T15P	 171.19-620	 DOUBLE-T	 CA3507

Accessories

For size	Insert clamping torque	Replacement blade	Shim key	Torque key
..-16	 3.0NM	 T00-15P	 9/64SMS875	 T00-15P30

General / ISO Turning

Steadyline®

MDT

Mini-Shaft™

Grooving

Parting-off

X4

Adapters
Clamping units

Accessories and
Spare parts

Workpiece
materials

General ISO Turning

GL...SVUNR/L – Toolholders for inserts VNMU – Metric/ Inch – Metric/ Inch

Steadyline®

MDT

Mini-Shaft™

Grooving

Parting-off

X4

Adapters
Clamping units

Accessories and
Spare parts

Workpiece
materials

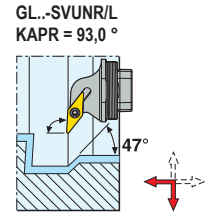
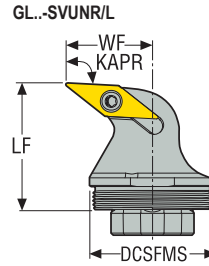
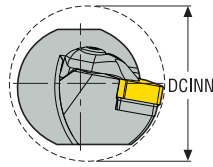

CTWS



- For inserts program, see page(s) 565, 566
- GAMO° = Rake angle, LAMS° = Inclination angle
- CTMS = GL size
- CTWS = Insert shape and size
- For holder code key, see page(s) 19
- For damping holders program, see page(s) 607, 608-620
- Right-hand version shown
- Please check availability at www.secotools.com / Seco Online Store

Designation	Item number	CTMS	DCSFMS	WF	LF	DCINN	CP*	KAPR°	GAMO°	LAMS°	Weight	CTWS
			mm <i>Inch</i>	mm <i>Inch</i>	mm <i>Inch</i>	mm <i>Inch</i>	bar <i>psi</i>				kg <i>lbs</i>	
GL32-SVUNR-22032-13	02974995	GL32	32,0 1.260	21,88 0.861	32 1.260	40,0 1.575	–	93,0	-5,0	-12,0	0,2 0.440	VN..1304.. VN..2.5.
GL32-SVUNL-22032-13	02974996	GL32	32,0 1.260	21,88 0.861	32 1.260	40,0 1.575	–	93,0	-5,0	-12,0	0,2 0.440	VN..1304.. VN..2.5.

Spare Parts

For size	Insert key	Insert screw	Insert shim	Key (T-handle)	Shim screw
...13	 H4B-T09P	 C03511-T09P	 PVN130308	 DOUBLE-T	 CA3507
...13	 H4B-T15P	 C03512-T15P	 PVN130308	 DOUBLE-T	 CA3507

Accessories

For size	Insert clamping torque	Replacement blade	Torque key
...13	 2.0NM	 T00-09P	 T00-09P20
...13	 3.0NM	 T00-15P	 T00-15P30

GL..-CCLNR/L – Toolholders for PCBN inserts CNMN – Metric/ Inch – Metric/ Inch

GL..-CCLNR/L
KAPR = 95,0°

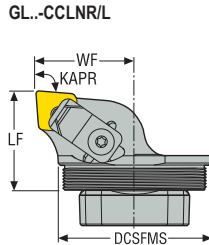
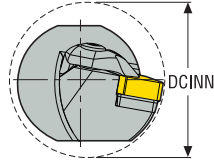
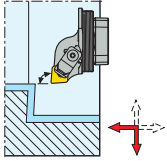

CTWS



- For inserts program, see page(s) 577
- GAMO° = Rake angle, LAMS° = Inclination angle
- CTMS = GL size
- CTWS = Insert shape and size
- For holder code key, see page(s) 19
- For damping holders program, see page(s) 607, 608-620
- Right-hand version shown
- Please check availability at www.secotools.com / Seco Online Store

Designation	Item number	CTMS	DCSFMS		WF		LF	DCINN	CP*	KAPR°	GAMO°	LAMS°	Weight	CTWS		
			mm	Inch	mm	Inch									mm	Inch
GL50-CCLNR-32032-12	02975024	GL50	50,0	1.969	31,88	1.255	32	1.260	63,0	2.480	-	95,0	-6,0	-6,0	0,4 0.880	CN.N1204.. CN.N43.
GL50-CCLNL-32032-12	02975025	GL50	50,0	1.969	31,88	1.255	32	1.260	63,0	2.480	-	95,0	-6,0	-6,0	0,4 0.880	CN.N1204.. CN.N43.

Spare Parts

For size	Clamp	Insert key	Insert shim	Key (T-handle)	Pressure plate	Shim screw
..-12	CC17P	H4B-T09P	CCN120312	DOUBLE-T	P1311	F94009-T09P

General / ISO Turning

Steadyline®

MDT

Mini-Shaft™

Grooving

Parting-off

X4

Adapters
Clamping units

Accessories and
Spare parts

Workpiece
materials

General ISO Turning

GL..-CRSNR/L – Toolholders for PCBN inserts RNGN-LF, RNGN and RNMN – Metric/ Inch – Metric/ Inch

Steadyline®

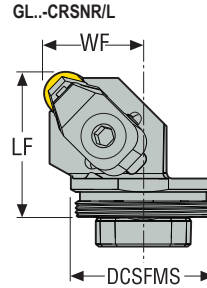
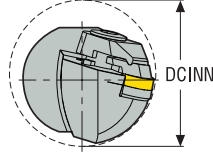

GL..-CRSNR/L
KAPR = 45,0 °

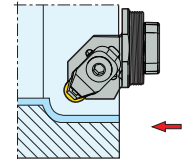

CTWS



- For inserts program, see page(s) 582, 583, 601, 604
- GAMO° = Rake angle, LAMS° = Inclination angle
- CTMS = GL size
- CTWS = Insert shape and size
- For holder code key, see page(s) 19
- For damping holders program, see page(s) 607, 608-620
- Right-hand version shown
- Please check availability at www.secotools.com / Seco Online Store

MDT

Mini-Shaft™

Designation	Item number	CTMS	DCSFMS	WF	LF	DCINN	CP*	KAPR°	GAMO°	LAMS°	Weight	CTWS
			mm <i>Inch</i>	mm <i>Inch</i>	mm <i>Inch</i>	mm <i>Inch</i>	bar <i>psi</i>				kg <i>lbs</i>	
GL32-CRSNR-22032-09	02809500	GL32	32,0 1.260	22,0 0.866	32 1.260	40,0 1.575	–	45,0	-6,0	-12,0	0,2 0.440	RN..0903.. RN.32.
GL32-CRSNL-22032-09	02809501	GL32	32,0 1.260	22,0 0.866	32 1.260	40,0 1.575	–	45,0	-6,0	-12,0	0,2 0.440	RN..0903.. RN.32.

Grooving

Spare Parts

Parting-off

For size	Cantilever clamp	Clamp key	Insert shim	Pressure plate	Shim screw
..-09	 CC17P-09	 4SMS795	 117.10-620	 P1311-09	 174.10-652-T07P

Accessories

X4

For size	Shim key
..-09	 T07P-2

Adapters
Clamping units

Accessories and
Spare parts

Workpiece
materials

GL..-CTUNR/L – Toolholders for PCBN inserts TNGN-LF, TNGN, TNGX, TNMN and TNMX – Metric/ Inch

GL..-CTUNR/L
KAPR = 93,0°

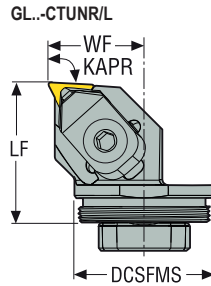
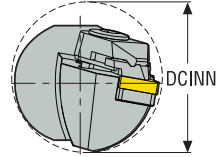
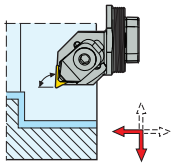

- For inserts program, see page(s) 558, 559, 560, 561, 591
- GAMO° = Rake angle, LAMS° = Inclination angle
- CTMS = GL size
- CTWS = Insert shape and size
- For holder code key, see page(s) 19
- For damping holders program, see page(s) 607, 608-620
- Right-hand version shown
- Please check availability at www.secotools.com / Seco Online Store

Designation	Item number	CTMS	DCSFMS	WF	LF	DCINN	CP*	KAPR°	GAMO°	LAMS°	Weight	CTWS
			mm Inch	mm Inch	mm Inch	mm Inch	bar psi				kg lbs	
GL32-CTUNR-22032-11	02809498	GL32	32,0 1.260	22,0 0.866	32 1.260	40,0 1.575	-	93,0	-6,0	-10,0	0,2 0.440	TN..1103.. TN..22.
GL32-CTUNL-22032-11	02809499	GL32	32,0 1.260	22,0 0.866	32 1.260	40,0 1.575	-	93,0	-6,0	-10,0	0,2 0.440	TN..1103.. TN..22.

Spare Parts

For size	Cantilever clamp	Clamp key	Insert shim	Pressure plate	Shim screw
..-11	 CC17P-06	 4SMS795	 CTN110308	 P1311-06	 CS2507-T07P

Accessories

For size	Shim key
..-11	 T07P-2

General ISO Turning

Steadyline®

MDT

Mini-Shaft™

Grooving

Parting-off

X4

Adapters
Clamping units

Accessories and
Spare parts

Workpiece
materials

GL.-CGIR/L-..JET – Toolholders for inserts LCGF, LCGN, LCMF and LCMR – Metric/ Inch

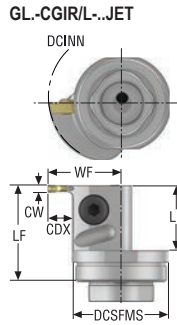

GL.-CGIR/L-..JET
KAPR = 0,0°

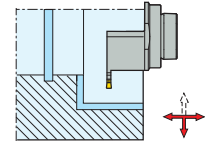



CTWS



- For inserts program, see page(s) 839-852, 854-855
- For more information on Jetstream Tooling® (High pressure coolant) and accessories, please see page(s) 38, 85-89, 1002
- For damping holders program, see page(s) 607, 608-620
- * DCINN – minimum bore diameter, see page(s) 705
- CTMS = GL size
- CTWS = Insert shape and size
- *** Type of Steadyline bar might limit the maximum coolant pressure, please see page(s) 85
- Right-hand version shown
- Please check availability at www.secotools.com / Seco Online Store

Designation	Item number	CTMS	DCSFMS	WF	LF	LH	CDX**	DCINN*	CP***	Weight	CW	TQ	CTWS
GL25-CGIR-19025-1902JET	03212509	GL25	25,0 0.984	19,0 0.748	25 0.984	23,0 0.906	6,0 0.236	32,0 1.260	200,0 2900.8	0,3 0.660	2,0 0.079	5,0 44.3	LC..1902..
GL25-CGIL-19025-1902JET	03212510	GL25	25,0 0.984	19,0 0.748	25 0.984	23,0 0.906	6,0 0.236	32,0 1.260	200,0 2900.8	0,4 0.880	2,0 0.079	5,0 44.3	LC..1902..

Spare Parts

For size	Clamp key	Clamp screw
1902	 T15P-7	 L85011-T15P

GL-CGJR/L-...JET – Toolholders for inserts LCGF, LCGN, LCMF and LCMR – Metric/ Inch

GL-CGJR/L-...JET
KAPR = 0,0 °

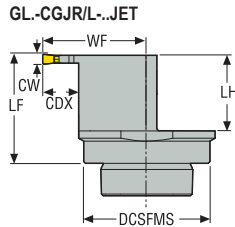
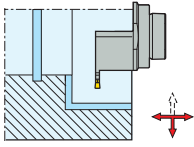

- For inserts program, see page(s) 839-852, 854-855
- For more information on Jetstream Tooling® (High pressure coolant) and accessories, please see page(s) 38, 85-89, 1002
- For damping holders program, see page(s) 607, 608-620
- * DCINN – minimum bore diameter, see page(s) 705
- CTMS = GL size
- CTWS = Insert shape and size
- *** Type of Steadyline bar might limit the maximum coolant pressure, please see page(s) 85
- Right-hand version shown
- Please check availability at www.secotools.com / Seco Online Store

Designation	Item number	CTMS	DCSFMS		WF	LF	LH	CDX**	DCINN*	CP***	Weight	TQ		CTWS									
			mm	Inch								mm	Nm		In/Lbs.								
GL32-CGJR-25032-1902JET	02947169	GL32	32,0	1.260	25,0	0.984	32	1.260	23,0	0.906	7,0	0.276	43,0	1.693	200,0	2900.8	0,2	0.440	2,0	0.079	5,0	44.3	LC..1902..
GL32-CGJL-25032-1902JET	02947170	GL32	32,0	1.260	25,0	0.984	32	1.260	23,0	0.906	7,0	0.276	43,0	1.693	200,0	2900.8	0,2	0.440	2,0	0.079	5,0	44.3	LC..1902..
GL40-CGJR-29032-1902JET	02947171	GL40	40,0	1.575	29,0	1.142	32	1.260	22,0	0.866	7,0	0.276	51,0	2.008	200,0	2900.8	0,2	0.440	2,0	0.079	5,0	44.3	LC..1902..
GL40-CGJL-29032-1902JET	02947172	GL40	40,0	1.575	29,0	1.142	32	1.260	22,0	0.866	7,0	0.276	51,0	2.008	200,0	2900.8	0,2	0.440	2,0	0.079	5,0	44.3	LC..1902..
GL50-CGJR-34032-1902JET	02947173	GL50	50,0	1.969	34,0	1.339	32	1.260	21,5	0.846	7,0	0.276	61,0	2.402	200,0	2900.8	0,3	0.660	2,0	0.079	5,0	44.3	LC..1902..
GL50-CGJL-34032-1902JET	02947174	GL50	50,0	1.969	34,0	1.339	32	1.260	21,5	0.846	7,0	0.276	61,0	2.402	200,0	2900.8	0,3	0.660	2,0	0.079	5,0	44.3	LC..1902..

Spare Parts

For size	Clamp key	Clamp screw	Key (T-handle)	Screw
1902	 H4B-T15P	 L85011-T15P	 DOUBLE-T	 P6SS3X5

General ISO Turning

Steadyline®

MDT

Mini-Shaft™

Grooving

Parting-off

X4

Adapters
Clamping units

Accessories and
Spare parts

Workpiece
materials

GL-CGGR/L-..JET – Toolholders for inserts LCGF, LCGN, LCMF and LCMR – Metric/ Inch

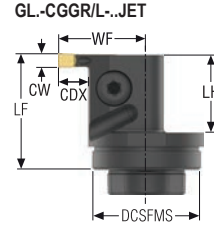
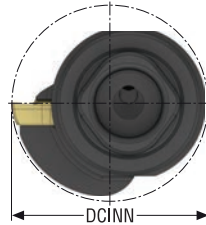
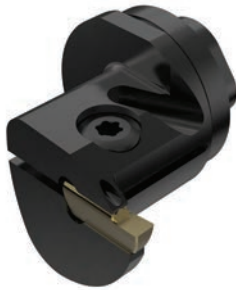

GL-CGGR/L-..JET
KAPR = 0,0°

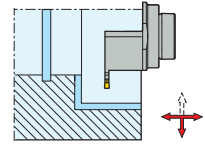

CTWS



- For inserts program, see page(s) 839-852, 854-855
- For more information on Jetstream Tooling® (High pressure coolant) and accessories, please see page(s) 38, 85-89, 1002
- For damping holders program, see page(s) 607, 608-620
- * DCINN – minimum bore diameter, see page(s) 705
- CTMS = GL size
- CTWS = Insert shape and size
- *** Type of Steadyline bar might limit the maximum coolant pressure, please see page(s) 85
- Right-hand version shown
- Please check availability at www.secotools.com / Seco Online Store

Designation	Item number	CTMS	DCSFMS	WF	LF	LH	CDX**	DCINN*	CP***	Weight	CW	TQ		CTWS
												mm	Inch	
GL25-CGGR-19025-1303JET	03212511	GL25	25,0 0.984	19,0 0.748	25 0.984	17,0 0.669	6,5 0.256	32,0 1.260	200,0 2900.8	0,1 0.220	3,0 0.118	5,0 44.3		LC..1303..
GL25-CGGL-19025-1303JET	03212512	GL25	25,0 0.984	19,0 0.748	25 0.984	17,0 0.669	6,5 0.256	32,0 1.260	200,0 2900.8	0,1 0.220	3,0 0.118	5,0 44.3		LC..1303..

Spare Parts

For size	Clamp key	Clamp screw	Key (T-handle)
1303	 H4B-T15P	 L85011-T15P	 DOUBLE-T

General ISO Turning

Steadyline®

MDT

Mini-Shaft™

Grooving

Parting-off

X4

Adapters
Clamping units

Accessories and
Spare parts

Workpiece
materials

GL.-CG.R/L-..JET – Toolholders for inserts LCGF, LCGN, LCMF and LCMR – Metric / Inch

GL.-CGIR/L-..JET
KAPR = 0,0 °

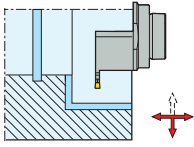

GL.-CGHR/L-..JET
KAPR = 0,0 °

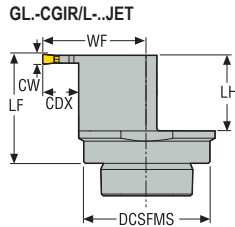
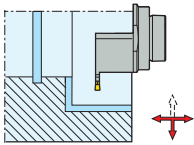

- For inserts program, see page(s) 839-852, 854-855
- For more information on Jetstream Tooling® (High pressure coolant) and accessories, please see page(s) 38, 85-89, 1002
- For damping holders program, see page(s) 607, 608-620
- * DCINN – minimum bore diameter, see page(s) 705
- CTMS = GL size
- CTWS = Insert shape and size
- *** Type of Steadyline bar might limit the maximum coolant pressure, please see page(s) 85
- Right-hand version shown
- Please check availability at www.secotools.com / Seco Online Store

Designation	Item number	CTMS	DCSFMS	WF	LF	LH	CDX**	DCINN*	CP***	Weight	CW	TQ	CTWS
GL32-CGIR-26032-1603JET	02947175	GL32	32,0 1.260	26,5 1.043	32 1.260	23,0 0.906	9,0 0.354	44,0 1.732	200,0 2900.8	0,2 0.440	3,0 0.118	5,0 44.3	LC..1603..
GL32-CGIL-26032-1603JET	02947176	GL32	32,0 1.260	26,5 1.043	32 1.260	23,0 0.906	9,0 0.354	44,0 1.732	200,0 2900.8	0,2 0.440	3,0 0.118	5,0 44.3	LC..1603..
GL40-CGIR-30032-1603JET	02947177	GL40	40,0 1.575	30,5 1.201	32 1.260	22,5 0.886	9,0 0.354	52,0 2.047	200,0 2900.8	0,2 0.440	3,0 0.118	5,0 44.3	LC..1603..
GL40-CGIL-30032-1603JET	02947178	GL40	40,0 1.575	30,5 1.201	32 1.260	22,5 0.886	9,0 0.354	52,0 2.047	200,0 2900.8	0,2 0.440	3,0 0.118	5,0 44.3	LC..1603..
GL50-CGIR-35032-1603JET	02947179	GL50	50,0 1.969	35,5 1.398	32 1.260	21,5 0.846	9,0 0.354	62,0 2.441	200,0 2900.8	0,3 0.660	3,0 0.118	5,0 44.3	LC..1603..
GL50-CGIL-35032-1603JET	02947180	GL50	50,0 1.969	35,5 1.398	32 1.260	21,5 0.846	9,0 0.354	62,0 2.441	200,0 2900.8	0,3 0.660	3,0 0.118	5,0 44.3	LC..1603..
GL32-CGHR-27032-1604JET	02947181	GL32	32,0 1.260	27,5 1.083	32 1.260	23,0 0.906	10,0 0.394	45,0 1.772	200,0 2900.8	0,2 0.440	4,0 0.157	5,0 44.3	LC..1604..
GL32-CGHL-27032-1604JET	02947182	GL32	32,0 1.260	27,5 1.083	32 1.260	23,0 0.906	10,0 0.394	45,0 1.772	200,0 2900.8	0,2 0.440	4,0 0.157	5,0 44.3	LC..1604..
GL40-CGHR-31032-1604JET	02947183	GL40	40,0 1.575	31,5 1.240	32 1.260	22,5 0.886	10,0 0.394	53,0 2.087	200,0 2900.8	0,2 0.440	4,0 0.157	5,0 44.3	LC..1604..
GL40-CGHL-31032-1604JET	02947184	GL40	40,0 1.575	31,5 1.240	32 1.260	22,5 0.886	10,0 0.394	53,0 2.087	200,0 2900.8	0,2 0.440	4,0 0.157	5,0 44.3	LC..1604..
GL50-CGHR-36032-1604JET	02947185	GL50	50,0 1.969	36,5 1.437	32 1.260	21,5 0.846	10,0 0.394	63,0 2.480	200,0 2900.8	0,3 0.660	4,0 0.157	5,0 44.3	LC..1604..
GL50-CGHL-36032-1604JET	02947186	GL50	50,0 1.969	36,5 1.437	32 1.260	21,5 0.846	10,0 0.394	63,0 2.480	200,0 2900.8	0,3 0.660	4,0 0.157	5,0 44.3	LC..1604..

Spare Parts

For size	Clamp key	Clamp screw	Key (T-handle)
1603	 H4B-T15P	 L85011-T15P	 DOUBLE-T
1604	H4B-T15P	L85011-T15P	DOUBLE-T

General ISO Turning
Steadyline®
MDT
Mini-Shaft™
Grooving
Parting-off
X4
Adapters
Clamping units
Accessories and Spare parts
Workpiece materials



MDT - Multi Directional Turning

The Seco MDT (Multi-Directional Turning) is universally suitable for a variety of applications including grooving, profiling, turning, parting-off, and threading. The unique Secoloc™ clamping delivers the best stability and safety in addition to high productivity and performance. Applications include turning parts with many different diameters, complicated profiles and grooves, replacing the need for several standard and special tools with a single Seco MDT.

- Unique insert clamping method for superb stability.
- MDT is available also in combination with Jetstream Tooling®, a high-pressure coolant system.

General information

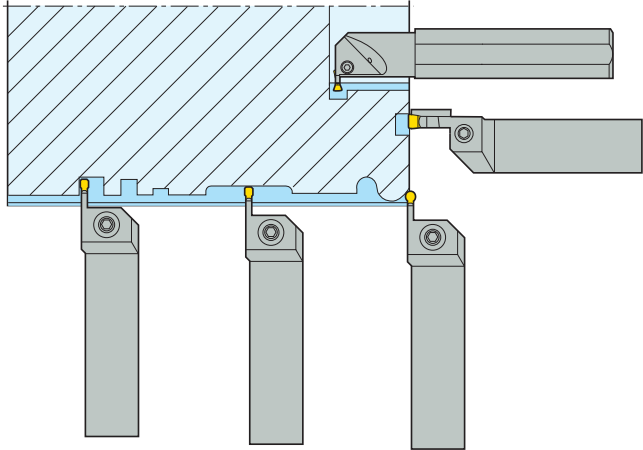
<p>The Seco MDT (Multi Directional Turning) system consists of holders and inserts for external radial, external axial and internal machining.</p> <p>The system can be used for:</p> <ul style="list-style-type: none"> • Turning • Profiling • Grooving • Parting-off • Threading <p>Suitable applications are turning of parts with many different diameters, complicated profiles and grooves. For complex parts of this type several standard and special tools can be replaced by one Seco MDT tool. Savings can be achieved through fewer tool changes and reduced tool stock.</p>	
<p>Seco MDT has a unique insert clamping method – Secoloc™.</p> <p>A combination of V-shaped top clamp and serrated contact surfaces between the underside of the insert and the toolholder offers superb stability.</p> <p>The relatively long insert also increases the stability.</p>	<p>The excellent stability gives a number of benefits</p> <ul style="list-style-type: none"> • Improved process safety • Increased metal removal capacity/productivity • Improved surface finish • Reduced vibration risk • Good repeatability (± 0.03 mm)



Seco Jetstream Tooling®

<p>Seco Jetstream Tooling® holders feature a rake face coolant jet, that may provide even better chip control and significantly longer tool life. For more information on Jetstream Tooling® and accessories, please see page(s) 85, 85-89, 89 and 1002.</p>	
--	--

- General ISO Turning
- Steadyline®
- MDT**
- Mini-Shaft™
- Grooving
- Parting-off
- X4
- Adapters Clamping units
- Accessories and Spare parts
- Workpiece materials

External holders, Seco-Capto™ – Metric/ Inch



CW						
8 0.315	JET	CFIR/L C6				
	non JET	CFIR/L C6				
6 0.236	JET	CFIR/L C5-C6		p. 719, 720	CFMR/L C5-C6	
	non JET	CFIR/L C5-C6		p. 776, 777		
	modular	V21-CIR/L C4-C5-C6		p. 826	V21-CMR/L C4-C5-C6	
5 0.197	JET	CFIR/L C4-C5-C6		p. 719, 720	CFMR/L C5-C6	
	non JET	CFIR/L C4-C5-C6		p. 776, 777		
	modular	V21-CIR/L C4-C5-C6		p. 826	V21-CMR/L C4-C5-C6	
4 0.157	JET	CFIR/L C4-C5-C6		p. 719, 720	CFMR/L C4-C5-C6	p. 721, 722
	non JET	CFIR/L C4-C5-C6		p. 776, 777		
	modular	V21-CIR/L C4-C5-C6		p. 826	V21-CMR/L C4-C5-C6	p. 826
3 0.118	JET	CFIR/L C4-C5-C6	p. 719, 720	CFMR/L C4-C5-C6	p. 721, 722	CFOR/L C4-C5-C6 p. 723, 724
	non JET	CFIR/L C4-C5-C6	p. 776, 777			
	modular	V21-CIR/L C4-C5-C6	p. 826	V21-CMR/L C4-C5-C6	p. 826	
2 0.079	JET	CFZR/L C4-C5-C6 *				
		CDX = 9	12	15	18	20
		0.354	0.472	0.591	0.709	0.787

* Due to the design, grooving depth is limited to given Ø

General ISO Turning

Steadyline®

MDT

Mini-Shaft™

Grooving

Parting-off

X4

Adapters
Clamping units

Accessories and
Spare parts

Workpiece
materials

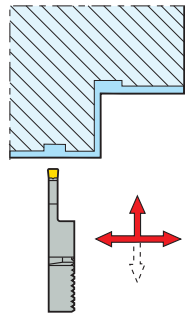

p. 719, 720 CFOR/L C6 p. 723, 724

p. 776, 777

p. 721, 722 CFOR/L C5-C6 p. 723, 724

p. 826

p. 721, 722 CFOR/L C4-C5-C6 p. 723, 724

p. 826

CFOR/L C4-C5-C6 p. 723, 724

p. 725

20 24 25 26 30 36 48 64
0.787 0.945 0.984 1.024 1.181 1.417 1.890 2.520

Ø52
2.047

- General ISO Turning
- Steadyline®
- MDT**
- Mini-Shaft™
- Grooving
- Parting-off
- X4
- Adapters Clamping units
- Accessories and Spare parts
- Workpiece materials

External holders – Metric



General ISO Turning

Steadyline®

MDT

Mini-Shaft™

Grooving

Parting-off

X4

Adapters
Clamping units

Accessories and
Spare parts

Workpiece
materials

CW					
8	JET	CFIR/L 25-32			
	non JET	CFIR/L 25-32			
6	JET	CFIR/L 20-25-32	p. 744, 745, 746		CFMR/L 25-32
	non JET	CFIR/L 20-25-32	p. 778, 779		CFMR/L 20-25-32
	modular	V21-CIR/L 20-25-32	p. 826		V21-CMR/L 20-25-32
5	JET	CFIR/L 20-25-32	p. 744, 745, 746		CFMR/L 25-32
	non JET	CFIR/L 20-25-32	p. 778, 779		CFMR/L 20-25-32
	modular	V21-CIR/L 20-25-32	p. 826		V21-CMR/L 20-25-32
4	JET	CFIR/L 20-25-32	p. 744, 745, 746		CFMR/L 20-25-32
	non JET	CFIR/L 12-16-20-25-32	p. 778, 779		CFMR/L 20-25-32
	modular	V21-CIR/L 20-25-32	p. 826		V21-CMR/L 20-25-32
3	JET	CFIR/L 20-25-32	p. 744, 745, 746		CFMR/L 20-25-32
	non JET	CFIR/L 12-16-20-25-32	p. 778, 779		CFMR/L 20-25-32
	modular	V21-CIR/L 20-25-32	p. 826		V21-CMR/L 20-25-32
2	JET	CFOR/L 12-16*	p. 753		CFSR/L 20*
	non JET	CFOR/L 12-16*	p. 789		CFSR/L 12-16*
			p. 755		CFZR/L 20-25*
			p. 789		CFZR/L 16*
		CDX = 9	12	15	18
			Ø25,4		Ø33
					Ø37
					20

* Due to the design, grooving depth is limited to given Ø
** CFTR/L 16-20-25 Ø50/1.969 p. 786

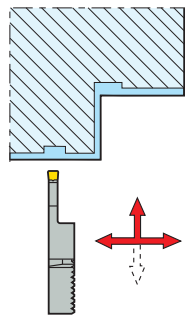

MDT

p. 744, 745, 746			
p. 778, 779	CFMR/L 25-32	p. 782, 783	CFSR/L 25-32 p. 791
		p. 749, 752	
		p. 782, 783	CFSR/L 25-32 p. 791
		p. 826	
	p. 749, 752		
	p. 782, 783	CFSR/L 25-32	p. 791
	p. 826		
CFPR/L 20-25*	p. 786	CFSR/L 25-32	p. 791
	p. 791	**	
		p. 757	
		p. 793	
20	24 25 26	30 32	40 48 64
	Ø50 Ø52		

- General ISO Turning
- Steadyline®
- MDT
- Mini-Shaft™
- Grooving
- Parting-off
- X4
- Adapters Clamping units
- Accessories and Spare parts
- Workpiece materials

Axial holders, Seco-Capto™ – Metric/ Inch



\varnothing of initial plunge INPLM-INPLX	CW	All Seco-Capto™ axial holders are JET			
200-500 7.874-19.686	8 0.315	CFIR/L C6			
	6 0.240	CFOR/L C5-C6			
	5 0.200	CFOR/L C4-C5-C6			
	4 0.160	CFOR/L C4-C5-C6			
	3 0.120	CFOR/L C4-C5-C6	p. 732, 733, 734, 735, 736, 737, 738, 739, 740, 741, 742, 743		
140-230 5.512-9.055	8 0.315	CFIR/L C6			
	6 0.240	CFIR/L C5-C6	p. 727, 728, 729, 730, 731		
	5 0.200	CFIR/L C4-C5-C6	p. 727, 728, 729, 730, 731	CFOR/L C4-C5-C6	
	4 0.160	CFIR/L C4-C5-C6	p. 727, 728, 729, 730, 731	CFOR/L C4-C5-C6	
	3 0.120	CFOR/L C4-C5-C6	p. 732, 733, 734, 735, 736, 737, 738, 739, 740, 741, 742, 743		
110-170 4.331-6.693	8 0.315	CFIR/L C6			
	6 0.240	CFIR/L C5-C6	p. 727, 728, 729, 730, 731		
	5 0.200	CFIR/L C4-C5-C6	p. 727, 728, 729, 730, 731	CFOR/L C4-C5-C6	
	4 0.160	CFIR/L C4-C5-C6	p. 727, 728, 729, 730, 731	CFOR/L C4-C5-C6	
	3 0.120	CFIR/L C4-C5-C6	p. 727, 728, 729, 730, 731	CFOR/L C4-C5-C6	p. 732, 733, 734, 735, 736, 737, 738, 739, 740, 741, 742, 743
90-130 3.543-5.118	8 0.315	CFIR/L C6			
	6 0.240	CFIR/L C5-C6	p. 727, 728, 729, 730, 731		
	5 0.200	CFIR/L C4-C5-C6	p. 727, 728, 729, 730, 731	CFOR/L C4-C5-C6	
	4 0.160	CFIR/L C4-C5-C6	p. 727, 728, 729, 730, 731	CFOR/L C4-C5-C6	
	3 0.120	CFIR/L C4-C5-C6	p. 727, 728, 729, 730, 731	CFOR/L C4-C5-C6	p. 732, 733, 734, 735, 736, 737, 738, 739, 740, 741, 742, 743
70-100 2.756-3.937	6 0.240	CFIR/L C5-C6			
	5 0.200	CFIR/L C4-C5-C6	p. 727, 728, 729, 730, 731	CFOR/L C4-C5-C6	
	4 0.160	CFIR/L C4-C5-C6	p. 727, 728, 729, 730, 731	CFOR/L C4-C5-C6	
	3 0.120	CFIR/L C4-C5-C6	p. 727, 728, 729, 730, 731	CFOR/L C4-C5-C6	p. 732, 733, 734, 735, 736, 737, 738, 739, 740, 741, 742, 743
55-80 2.165-3.150	6 0.240	CFIR/L C5-C6			
	5 0.200	CFIR/L C4-C5-C6	p. 727, 728, 729, 730, 731	CFOR/L C4-C5-C6	
	4 0.160	CFIR/L C4-C5-C6	p. 727, 728, 729, 730, 731	CFOR/L C4-C5-C6	
	3 0.120	CFIR/L C4-C5-C6	p. 727, 728, 729, 730, 731	CFOR/L C4-C5-C6	p. 732, 733, 734, 735, 736, 737, 738, 739, 740, 741, 742, 743
		CDX = 9 0.354	12 0.470	15 0.590	18 0.700

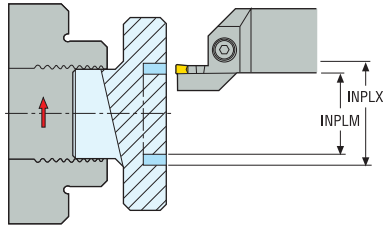

p. 727, 728, 729, 730, 731	CFOR/L C6	p. 732, 733, 734, 735, 736, 737, 738, 739, 740, 741, 742, 743
		p. 732, 733, 734, 735, 736, 737, 738, 739, 740, 741, 742, 743
		p. 732, 733, 734, 735, 736, 737, 738, 739, 740, 741, 742, 743
p. 732, 733, 734, 735, 736, 737, 738, 739, 740, 741, 742, 743		
p. 727, 728, 729, 730, 731	CFOR/L C6	p. 732, 733, 734, 735, 736, 737, 738, 739, 740, 741, 742, 743
CFOR/L C5-C6		p. 732, 733, 734, 735, 736, 737, 738, 739, 740, 741, 742, 743
		p. 732, 733, 734, 735, 736, 737, 738, 739, 740, 741, 742, 743
p. 732, 733, 734, 735, 736, 737, 738, 739, 740, 741, 742, 743		
p. 727, 728, 729, 730, 731	CFOR/L C6	p. 732, 733, 734, 735, 736, 737, 738, 739, 740, 741, 742, 743
CFOR/L C5-C6		p. 732, 733, 734, 735, 736, 737, 738, 739, 740, 741, 742, 743
		p. 732, 733, 734, 735, 736, 737, 738, 739, 740, 741, 742, 743
p. 732, 733, 734, 735, 736, 737, 738, 739, 740, 741, 742, 743		
p. 727, 728, 729, 730, 731	CFOR/L C6	p. 732, 733, 734, 735, 736, 737, 738, 739, 740, 741, 742, 743
CFOR/L C5-C6		p. 732, 733, 734, 735, 736, 737, 738, 739, 740, 741, 742, 743
		p. 732, 733, 734, 735, 736, 737, 738, 739, 740, 741, 742, 743
p. 732, 733, 734, 735, 736, 737, 738, 739, 740, 741, 742, 743		
p. 727, 728, 729, 730, 731	CFOR/L C6	p. 732, 733, 734, 735, 736, 737, 738, 739, 740, 741, 742, 743
CFOR/L C5-C6		p. 732, 733, 734, 735, 736, 737, 738, 739, 740, 741, 742, 743
		p. 732, 733, 734, 735, 736, 737, 738, 739, 740, 741, 742, 743
p. 732, 733, 734, 735, 736, 737, 738, 739, 740, 741, 742, 743		
p. 727, 728, 729, 730, 731	CFOR/L C6	p. 732, 733, 734, 735, 736, 737, 738, 739, 740, 741, 742, 743
CFOR/L C5-C6		p. 732, 733, 734, 735, 736, 737, 738, 739, 740, 741, 742, 743
		p. 732, 733, 734, 735, 736, 737, 738, 739, 740, 741, 742, 743
p. 732, 733, 734, 735, 736, 737, 738, 739, 740, 741, 742, 743		

18 0.700	24 0.945	30 1.180	36 1.415	48 1.890
-------------	-------------	-------------	-------------	-------------

- General ISO Turning
- Steadyline®
- MDT
- Mini-Shaft™
- Grooving
- Parting-off
- X4
- Adapters Clamping units
- Accessories and Spare parts
- Workpiece materials

Axial holders – Metric

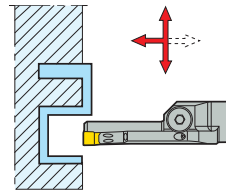
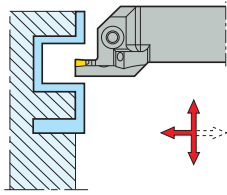

\varnothing of initial plunge INPLM-INPLX	CW		
200-500	8	CF(G)IR/L 32 / CFIR/L 32JET	
	6	CFOR/L 25JET	
	5	CFOR/L 25JET	
	4	CFOR/L 25JET	
	3	CFOR/L 25JET	p. 766, 767, 771, 772
140-230	8	CF(G)IR/L 32 / CFIR/L 32JET	
	6	CF(G)IR/L 25 / CFIR/L 25JET	p. 761, 762
	5	CF(G)IR/L 25 / CFIR/L 25JET	p. 761, 762
	4	CF(G)IR/L 25 / CFIR/L 25JET	p. 761, 762, 795, 796
	3	CFOR/L 25JET	p. 766, 767, 771, 772
110-170	8	CF(G)IR/L 32 / CFIR/L 32JET	
	6	CF(G)IR/L 25 / CFIR/L 25JET	p. 761, 762, 795, 796
	5	CF(G)IR/L 25 / CFIR/L 25JET	p. 761, 762
	4	CF(G)IR/L 25 / CFIR/L 25JET	p. 761, 762, 795, 796
	3	CFOR/L 25JET	p. 766, 767, 771, 772
90-130	8	CF(G)IR/L 32 / CFIR/L 32JET	
	6	CF(G)IR/L 25 / CFIR/L 25JET	p. 761, 762, 795, 796
	5	CF(G)IR/L 25 / CFIR/L 25JET	p. 761, 762
	4	CF(G)IR/L 25 / CFIR/L 25JET	p. 761, 762, 795, 796
	3	CF(G)IR/L 25 / CFIR/L 25JET	p. 761, 762, 795, 796
70-100	6	CF(G)IR/L 25 / CFIR/L 25JET	p. 761, 762, 795, 796
	5	CF(G)IR/L 25 / CFIR/L 25JET	p. 761, 762
	4	CF(G)IR/L 25 / CFIR/L 25JET	p. 761, 762, 795, 796
	3	CF(G)IR/L 25 / CFIR/L 25JET	p. 761, 762, 795, 796
	55-80	6	CFIR/L 25JET
	5	CFIR/L 25JET	p. 759, 761, 762
	4	CFIR/L 25JET	p. 759, 761, 762
	3	CFIR/L 25JET	p. 759, 761, 762

CDX = 9 12 15 18

- General ISO Turning
- Steadyline®
- MDT
- Mini-Shaft™
- Grooving
- Parting-off
- X4
- Adapters Clamping units
- Accessories and Spare parts
- Workpiece materials

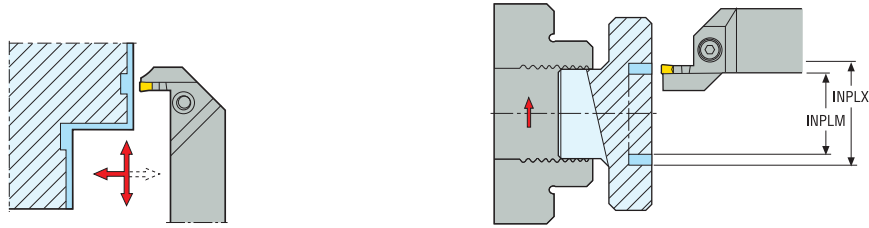

p. 763, 795, 796		CFOR/L 32JET	p. 768, 773
		p. 766, 767, 771, 772	
		p. 766, 767, 771, 772	
p. 763, 795, 796		CFOR/L 32JET	p. 768, 773
CFOR/L 25JET		p. 766, 767, 771, 772	
		p. 766, 767, 771, 772	
p. 763, 795, 796		CFOR/L 32JET	p. 768, 773
CFOR/L 25JET		p. 766, 767, 771, 772	
		p. 766, 767, 771, 772	
p. 763, 795, 796		CFOR/L 32JET	p. 768, 773
CFOR/L 25JET		p. 766, 767, 771, 772	
		p. 766, 767, 771, 772	
		CFOR/L 25JET	p. 766, 767, 771, 772
		p. 766, 767, 771, 772	
		CFOR/L 25JET	p. 766, 767, 771, 772
		p. 766, 767, 771, 772	
		CFOR/L 25JET	p. 766, 767, 771, 772
		p. 766, 767, 771, 772	

18 24 30 36 48

- General ISO Turning
- Steadyline®
- MDT
- Mini-Shaft™
- Grooving
- Parting-off
- X4
- Adapters
Clamping units
- Accessories and
Spare parts
- Workpiece
materials

Internal holders, Seco-Capto – Metric/ Inch, Bar – Metric

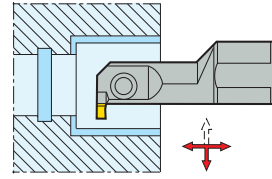
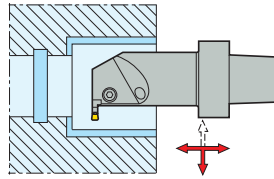

DCINN _{min}	CW	Shank type		
45 1.772	6 0.240	Seco-Capto	CGGR/L C5-C6	
		Bar	CGGR/L Ø40	
	5 0.200	Seco-Capto	CGGR/L C4-C5-C6	
		Bar	CGGR/L Ø40	
	4 0.160	Seco-Capto	CGGR/L C4-C5-C6	
		Bar	CGGR/L Ø40*	
3 0.120	Seco-Capto	CGGR/L C4-C5-C6	p. 807, 808	
	Bar	CGGR/L Ø40	p. 813	
32 1.260	6 0.240	Seco-Capto	CGFR/L C5-C6	
		Bar	CGFR/L Ø32	
	5 0.200	Seco-Capto	CGFR/L C4-C5-C6	
		Bar	CGFR/L Ø32	
	4 0.160	Seco-Capto	CGGR/L C4-C5-C6	
		Bar	CGGR/L Ø32	
3 0.120	Seco-Capto	CGIR/L C4-C5-C6		
	Bar	CGIR/L Ø32		
25 0.984	4 0.160	Seco-Capto	CGFR/L C5-C6	
		Bar	CGFR/L Ø25	
	3 0.120	Seco-Capto	CGHR/L C5-C6	
		Bar	CGHR/L Ø25	
	2 0.080	Seco-Capto	CGJR/L C4-C5-C6	
		Bar	CGJR/L Ø25	
20 0.787	4 0.160	Seco-Capto	CGFR/L C4-C5-C6	p. 802, 803
		Bar	CGFR/L Ø20	p. 809
	3 0.120	Seco-Capto	CGFR/L C4-C5-C6	p. 802, 803
		Bar	CGFR/L Ø20	p. 809
	2 0.080	Seco-Capto	CGHR/L C4-C5-C6	p. 806
		Bar	CGHR/L Ø20	p. 815
16 0.630	3 0.120	Seco-Capto	CGER/L C4-C5-C6	p. 802, 803
		Bar	CGER/L Ø16	p. 809

CDX = 3
0.120

5,5
0.217

6
0.240

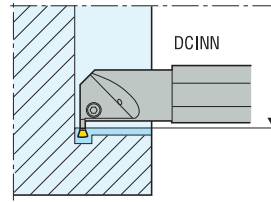
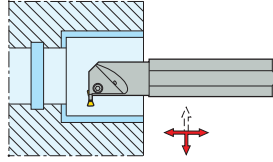

General ISO Turning

Steadyline®

MDT

Mini-Shaft™

Grooving

Parting-off

X4

Adapters
Clamping units

Accessories and
Spare parts

Workpiece
materials

p. 807, 808	
p. 813	
p. 807, 808	
p. 813	
p. 807, 808	
p. 813	
p. 804, 805	
p. 811	
p. 804, 805	
p. 811	
p. 804, 805	CGHR/L C5-C6 p. 802, 803
p. 811	CGHR/L Ø32 p. 809
p. 804, 805	CGJR/L C5-C6 p. 802, 803
p. 811	CGJR/L Ø32 p. 809
p. 802, 803	
p. 809	
p. 802, 803	
p. 809	
p. 806	
p. 815	

6 7,5 8 9 10 10,5 12
0.240 0.295 0.315 0.354 0.400 0.413 0.470

External holders – Inch



General ISO Turning

Steadyline®

MDT

Mini-Shaft™

Grooving

Parting-off

X4

Adapters
Clamping units

Accessories and
Spare parts

Workpiece
materials

CW					
0.315	JET	CFIR/L 1.000-1.250			
	non JET	CFIR/L 1.000-1.250			
0.236	JET	CFIR/L 1.000-1.250	p. 747, 748	CFMR/L 1.000-1.250	
	non JET	CFIR/L 1.000-1.250	p. 780, 781	CFMR/L 1.000-1.250-1.500	
0.197	JET	CFIR/L 0.750-1.000-1.250	p. 747, 748	CFMR/L 1.000-1.250	
	non JET	CFIR/L 0.750-1.000-1.250	p. 780, 781	CFMR/L 1.000-1.250-1.500	
0.157	JET	CFIR/L 0.750-1.000-1.250	p. 747, 748	CFMR/L 0.750-1.000-1.250	p. 750, 751
	non JET	CFIR/L 0.750-1.000-1.250	p. 780, 781	CFMR/L 0.750-1.000-1.250-1.500	p. 784, 785
0.118	JET	CFIR/L 0.750-1.000-1.250	p. 747, 748	CFMR/L 0.750-1.000-1.250	p. 750, 751
	non JET	CFIR/L 0.625-0.750-1.000-1.250	p. 780, 781	CFMR/L 0.750-1.000-1.250-1.500	p. 784, 785
0.079	JET	CFOR/L 0.500*	p. 754	CFSR/L 0.750*	p. 756
	non JET	CFOR/L 0.500-0.625*	p. 790	CFSR/L 0.500-0.625*	p. 790
		CDX = .354	.472	.591	.709
			Ø1.000	Ø1.299	Ø1.457
					.787

* Due to the design, grooving depth is limited to given Ø
** CFTR/L 0.750-1.000 p. 787

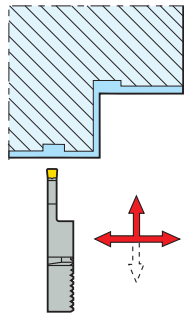

- General ISO Turning
- Steadyline®
- MDT**
- Mini-Shaft™
- Grooving
- Parting-off
- X4
- Adapters
Clamping units
- Accessories and
Spare parts
- Workpiece
materials

MDT

p. 747, 748			
p. 780, 781	CFMR/L 1.000-1.250-1.500	p. 784, 785	CFSR/L 1.250 p. 792
		p. 750, 751	
		p. 784, 785	CFSR/L 1.000-1.250 p. 792
	p. 750, 751		
	p. 784, 785	CFSR/L 1.000-1.250	p. 792
CFPR/L 0.625*	p. 787	CFSR/L 1.000-1.250	p. 792
	p. 792 **		
		p. 758	
		p. 794	
.787	.945 .984 1.024	1.181 1.260	1.575 1.890 2.520

Ø1.969 Ø2.047

Axial holders – Inch



	Ø of initial plunge INPLM-INPLX	CW				
MDT	7.874-19.685	.315	CF(G)IR/L 1.000 / CFIR/L 1.000-1.250JET			
		.236	CFOR/L 1.000JET			
		.197	CFOR/L 1.000JET			
		.157	CFOR/L 1.000JET			
		.118	CFOR/L 1.000JET p. 774, 775			
Mini-Shaft™	5.512-9.055	.315	CF(G)IR/L 1.000 / CFIR/L 1.000-1.250JET			
		.236	CF(G)IR/L 1.000 / CFIR/L 1.000JET p. 764, 765, 797, 798, 801			
		.197	CF(G)IR/L 1.000 / CFIR/L 1.000JET p. 764, 765, 797, 798			
		.157	CF(G)IR/L 1.000 / CFIR/L 1.000JET p. 764, 765, 797, 798			
		.118	CFOR/L 1.000JET p. 774, 775			
Grooving	4.331-6.693	.315	CF(G)IR/L 1.000 / CFIR/L 1.000-1.250JET			
		.236	CF(G)IR/L 1.000 / CFIR/L 1.000JET p. 764, 765, 797, 798, 801			
		.197	CF(G)IR/L 1.000 / CFIR/L 1.000JET p. 764, 765, 797, 798			
		.157	CF(G)IR/L 1.000 / CFIR/L 1.000JET p. 764, 765			
		.118	CFOR/L 1.000JET p. 774, 775			
Parting-off	3.543-5118	.315	CF(G)IR/L 1.000 / CFIR/L 1.000-1.250JET			
		.236	CF(G)IR/L 1.000 / CFIR/L 1.000JET p. 764, 765, 797, 798, 801			
		.197	CF(G)IR/L 1.000 / CFIR/L 1.000JET p. 764, 765, 797, 798			
		.157	CF(G)IR/L 1.000 / CFIR/L 1.000JET p. 764, 765, 797, 798, 801			
		.118	CF(G)IR/L 1.000 / CFIR/L 1.000JET p. 764, 765, 797, 798, 801			
X4	2.756-3.937	.236	CF(G)IR/L 1.000 / CFIR/L 1.0005JET p. 764, 765, 797, 798			
		.197	CF(G)IR/L 1.000 / CFIR/L 1.000JET p. 764, 765, 797, 798			
		.157	CF(G)IR/L 1.000 / CFIR/L 1.000JET p. 764, 765, 797, 798, 801			
		.118	CF(G)IR/L 1.000 / CFIR/L 1.000JET p. 764, 765, 797, 798, 801			
		.118	CFOR/L 1.000JET p. 774, 775			
Adapters Clamping units	2.165-3.150	.236	CFIR/L 1.000JET p. 760, 764, 765			
		.197	CFIR/L 1.000JET p. 760, 764, 765			
		.157	CFIR/L 1.000JET p. 760, 764, 765			
		.118	CFIR/L 1.000JET p. 760, 764, 765			
		.118	CFOR/L 1.000JET p. 774, 775			
Accessories and Spare parts			CDX = .354	.472	.591	.709

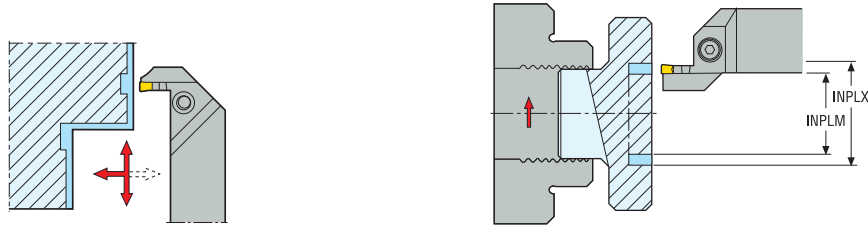

p. 764, 765, 797, 798, 801	CFOR/L 1.250JET	p. 769, 770, 774, 775
		p. 774, 775
		p. 774, 775
		p. 769, 770, 774, 775
p. 764, 765, 797, 798, 801	CFOR/L 1.250JET	p. 769, 770, 774, 775
CFOR/L 1.000JET		p. 774, 775
		p. 774, 775
		p. 769, 770, 774, 775
p. 764, 765, 797, 798, 801	CFOR/L 1.250JET	p. 769, 770, 774, 775
CFOR/L 1.000JET		p. 774, 775
		p. 774, 775
		p. 769, 770, 774, 775
p. 764, 765, 797, 798, 801	CFOR/L 1.250JET	p. 769, 770, 774, 775
CFOR/L 1.000JET		p. 774, 775
		p. 774, 775
		p. 769, 770, 774, 775
	CFOR/L 1.000JET	p. 774, 775
		p. 774, 775
		p. 769, 770, 774, 775
	CFOR/L 1.000JET	p. 774, 775
		p. 774, 775
		p. 769, 770, 774, 775
.709	.945	1.181
		1.417
		1.890

- General ISO Turning
- Steadyline®
- MDT
- Mini-Shaft™
- Grooving
- Parting-off
- X4
- Adapters
Clamping units
- Accessories and
Spare parts
- Workpiece
materials

Internal holders – Inch

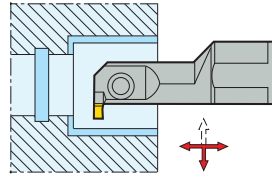

DCINN _{min}	CW	Shank type	
1.800	0.236	Bar	CGGR/L Ø1.500
	0.197	Bar	CGGR/L Ø1.500
	0.157	Bar	CGGR/L Ø1.500
	0.118	Bar	CGGR/L Ø1.500
1.260	0.236	Bar	CGFR/L Ø1.250 p. 812
	0.197	Bar	CGFR/L Ø1.250 p. 812
	0.157	Bar	CGGR/L Ø1.250
	0.118	Bar	CGIR/L Ø1.250
0.985	0.157	Bar	CGFR/L Ø1.000 p. 810
	0.118	Bar	CGHR/L Ø1.000 p. 810
	0.079	Bar	CGJR/L Ø1.000 p. 816
0.790	0.157	Bar	CGFR/L Ø0.750 p. 810
	0.118	Bar	CGFR/L Ø0.750 p. 810
	0.079	Bar	CGHR/L Ø0.750 p. 816
0.630	0.118	Bar	CGER/L Ø0.625 p. 810
			CDX = .118 .197 .216 .276 .295

- General ISO Turning
- Steadyline®
- MDT
- Mini-Shaft™
- Grooving
- Parting-off
- X4
- Adapters Clamping units
- Accessories and Spare parts
- Workpiece materials



					p. 814
					p. 814
					p. 814
		p. 812	CGHR/L Ø1.250		p. 810
	p. 812	CGJR/L Ø1.250			p. 810
.295	.354	.394	.413	.440	.515

- General ISO Turning
- Steadyline®
- MDT
- Mini-Shaft™
- Grooving
- Parting-off
- X4
- Adapters
Clamping units
- Accessories and
Spare parts
- Workpiece
materials

General ISO Turning

Axial modular blades – Metric



Steadyline®

MDT

INPLM- INPLX	CW	
17-200		V21-CMR/L p. 827, 828, 829, 830
26-100	4	V21-CIR/L p. 827, 828, 829, 830
17-34		V21-CHR/L p. 827, 828, 829, 830
17-200		V21-COR/L p. 827, 828, 829, 830
33-76	3	V21-CKR/L p. 827, 828, 829, 830
17-39		V21-CJR/L p. 827, 828, 829, 830

CDX = 10,5 12 18 20

Mini-Shaft™

Holders for modular blades – Metric/ Inch

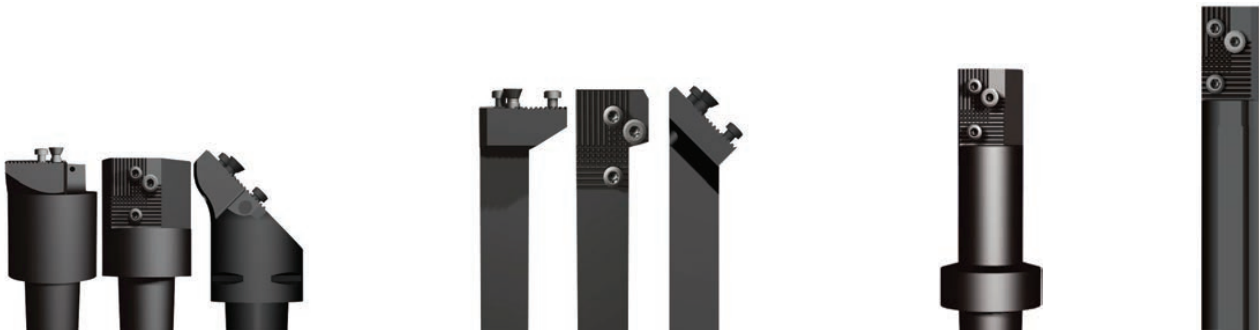

C4-C5-C6	p. 818, 819	20-25-32 / 0,750 - 1.000 - 1.250	p. 820, 821	C4, C5, C6, Ø25-32-40 / 1.000 - 1.250 - 1.500	p. 822, 823, 825
----------	-------------	----------------------------------	-------------	---	------------------

Grooving

Parting-off

X4

External MTM holders – Metric/ Inch

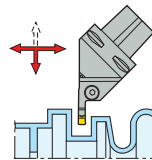

Adapters
Clamping units

Accessories and
Spare parts

CW		
8 0.315	JET	CDIR/L C6 p. 817
6 0.240	JET	CDIR/L C6 p. 817
5 0.200	JET	CDIR/L C6 p. 817
4 0.160	JET	CDIR/L C6 p. 817
3 0.120	JET	CDIR/L C6 p. 817

CDX = 9 12 15 18 24
0.354 0.470 0.590 0.700 0.945

Workpiece
materials

Seco-Capto™ – External toolholders

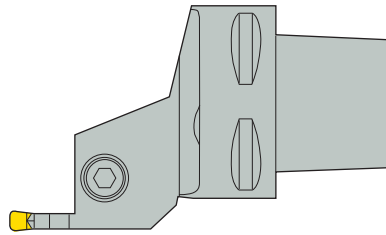

C4	C	F	I	R	- 27	050	- 03
1	2	3	4	5	6	7	8

1. Seco-Capto™ size	2. Insert clamping	3. Toolholder setting angle
<p>C3 = 32 mm C4 = 40 mm C5 = 50 mm C6 = 63 mm</p>	<p>C</p>	<p>α G = 0° R = 15° T = 30° S = 45° W = 60° K = 75° F = 90° B = 105° E = 120° D = 135°</p>
3. Maximum grooving/turning depth	4. Version	
<p>E = 1,0 x CW F = 1,5 x CW G = 2,0 x CW H = 2,5 x CW I = 3,0 x CW J = 3,5 x CW K = 4,0 x CW</p>	<p>L = 4,5 x CW M = 5,0 x CW N = 5,5 x CW O = 6,0 x CW S = 8,0 x CW T = 8,5 x CW Z = 12,5 x CW</p> <p>X = Special</p>	<p>R L</p>
6. WF-dimension	7. LF-dimension	8. Seat size
<p>27 = 27 mm 35 = 35 mm 45 = 45 mm etc.</p>	<p>12 = 12 mm 16 = 16 mm 20 = 20 mm etc.</p>	<p>03 = 2,3 mm 04 = 3,1 mm 05 = 4,1 mm 06 = 5,1 mm 08 = 6,8 mm 1902 = 1,6 mm 2802 = 1,6 mm etc.</p>

General ISO Turning

Steadyline®

MDT

Mini-Shaft™

Grooving

Parting-off

X4

Adapters
Clamping units

Accessories and
Spare parts

Workpiece
materials

Seco-Capto™ – Internal toolholders and modular GL-turning heads

General ISO Turning

Steadyline®

MDT

Mini-Shaft™

Grooving

Parting-off

X4

Adapters
Clamping units

Accessories and
Spare parts

Workpiece
materials

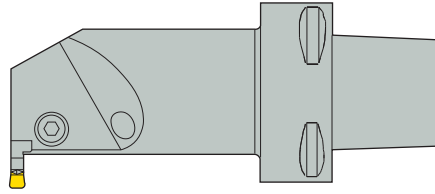

C4	C	G	G	R	- 25	090	- 03
1	2	3	4	5	6	7	8

1. Seco-Capto™ and GL size		2. Insert clamping		3. Toolholder setting angle	
	C3 = 32 mm C4 = 40 mm C5 = 50 mm C6 = 63 mm		GL25 = 25 mm GL32 = 32 mm GL40 = 40 mm GL50 = 50 mm		α G = 0° R = 15° T = 30° S = 45° W = 60° K = 75° F = 90° B = 105° E = 120° D = 135°
4. Maximum grooving/turning depth		5. Version		6. WF-dimension	
	E = 1,0 x CW F = 1,5 x CW G = 2,0 x CW H = 2,5 x CW I = 3,0 x CW J = 3,5 x CW K = 4,0 x CW	L = 4,5 x CW M = 5,0 x CW N = 5,5 x CW O = 6,0 x CW S = 8,0 x CW T = 8,5 x CW Z = 12,5 x CW X = Special			12 = 12 mm 16 = 16 mm 20 = 20 mm etc.
7. LF-dimension			8. Seat size		
	065 = 65 mm 075 = 75 mm 080 = 80 mm etc.		1303 = 2,4 mm 1304 = 3,4 mm 03, 1603 = 2,3 mm 04, 1604 = 3,1 mm 05, 1605 = 4,1 mm 06, 1606 = 5,1 mm 1902 = 1,6 mm etc.		

Seco-Capto™ – External toolholders



C	F	Z	R	20	20	M	2802	RB	JET
1	2	3	4	5	6	7	8	12	13

C	F	I	R	25	25	M	04	L	100	070
1	2	3	4	5	6	7	8	9	10	11

1. Insert clamping	2. Toolholder setting angle
<p>Clamp</p>	<p> α G = 0° R = 15° T = 30° S = 45° W = 60° K = 75° F = 90° B = 105° E = 120° D = 135° </p>

3. Maximum grooving/turning depth	4. Version
<p> E = 1,0 x CW F = 1,5 x CW G = 2,0 x CW H = 2,5 x CW I = 3,0 x CW J = 3,5 x CW K = 4,0 x CW L = 4,5 x CW </p>	<p> M = 5,0 x CW N = 5,5 x CW O = 6,0 x CW P = 6,25 x CW S = 8,0 x CW T = 8,5 x CW Z = 12,5 x CW X = Special </p> <p>R L</p>

5. Shank height	6. Shank width	7. Tool length
<p> 12 = 12 mm 16 = 16 mm 20 = 20 mm etc. </p>	<p> 12 = 12 mm 16 = 16 mm 20 = 20 mm etc. </p>	<p> H = 100 mm K = 125 mm M = 150 mm P = 170 mm R = 200 mm </p>

General ISO Turning
Steadyline®
MDT
Mini-Shaft™
Grooving
Parting-off
X4
Adapters
Clamping units
Accessories and Spare parts
Workpiece materials

- General ISO Turning
- Steadyline®
- MDT
- Mini-Shaft™
- Grooving
- Parting-off
- X4
- Adapters Clamping units
- Accessories and Spare parts
- Workpiece materials

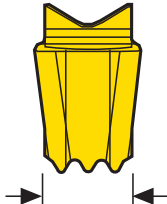
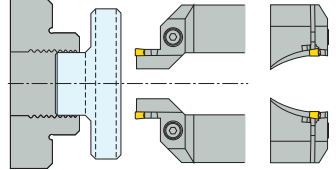
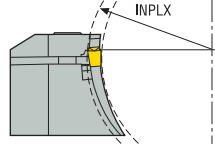
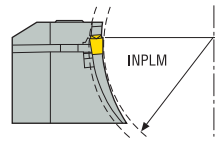
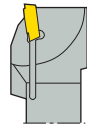
8. Seat size	9. Tang curvature direction
 <p>Seat size</p> <ul style="list-style-type: none"> 1303 = 2,4 mm 1304 = 3,4 mm 1603 = 2,3 mm 1604 = 3,1 mm 1605 = 4,1 mm 1606 = 5,1 mm 1902 = 1,6 mm 2802 = 1,6 mm 3008 = 6,8 mm etc. 	 <p style="text-align: right;">R L</p> <p>Additional information for axial machining</p>
10. Maximum diameter	11. Minimum diameter
<p>100 mm (D₁)</p>  <p>Additional information for axial machining</p>	<p>070 = 70 mm (D₂)</p>  <p>Additional information for axial machining</p>
12. Holder modification	13. Cooling system
 <p>RB = Reinforced blade for specified diameter</p>	<p>JET = Jetstream Tooling® JETI = Jetstream Tooling® integrated coolant inlet</p> <p>Additional information for axial machining</p>

Internal toolholders

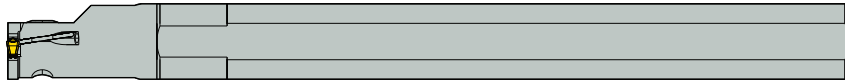

A	20	R	-	C	G	F	R	1303
1	2	3		4	5	6	7	8

1. Toolholder type		2. Shank diameter			
A = Steel with coolant passage S = Solid steel E = Solid carbide with brazed* cutting head and coolant passage * Brazed or equivalent		DMM 12 = 12 mm 20 = 20 mm 25 = 25 mm etc.			
3. Tool length					
LF		K = 125 mm L = 140 mm M = 150 mm N = 160 mm P = 170 mm	Q = 180 mm R = 200 mm S = 250 mm T = 300 mm U = 350 mm V = 400 mm		
4. Insert clamping		5. Toolholder setting angle			
C		α G = 0° R = 15° T = 30° S = 45° W = 60° K = 75° F = 90° B = 105° E = 120° D = 135°			
6. Maximum grooving/turning depth		7. Version		8. Seat size	
CW E = 1,0 x CW F = 1,5 x CW G = 2,0 x CW H = 2,5 x CW I = 3,0 x CW J = 3,5 x CW K = 4,0 x L = 4,5 x CW M = 5,0 x CW N = 5,5 x CW O = 6,0 x CW S = 8,0 x CW T = 8,5 x CW Z = 12,5 x CW X = Special		R L		1303 = 2,4 mm 1304 = 3,4 mm 1603 = 2,3 mm 1604 = 3,1 mm 1605 = 4,1 mm 1606 = 5,1 mm 1902 = 1,6 mm 2802 = 1,6 mm	

General ISO Turning

Steadyline®

MDT

Mini-Shaft™

Grooving

Parting-off

X4

Adapters
Clamping units

Accessories and
Spare parts

Workpiece
materials

Inserts

General ISO Turning

Steadyline®

MDT

Mini-Shaft™

Grooving

Parting-off

X4

Adapters
Clamping units

Accessories and
Spare parts



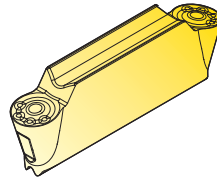
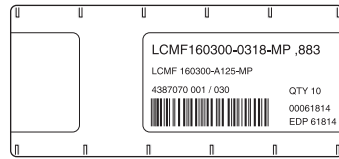

Workpiece
materials

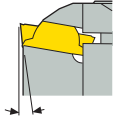





L	C	M	F	16	03	00	-	0318		-	MP
1	2	3	4	5	6	7		8	9		10



1. Shape	2. Front clearance angle
<p>L</p>  <p>Rectangular</p>	 <p>C = 7°</p>

3. Tolerances									
Tolerance class	Tolerances: mm/In			For insert width, CW mm					
	CW	RE	IGL	2	3	4	5	6	8
G	0,025	0,025	0.040		•	•	•	•	•
M	0,050	0,050	0.080	•	•	•	•	•	•

4. Insert type			
R		Single ended with chipbreaker	N  Single ended without chipbreaker
F		Double ended with chipbreaker	A  Double ended without chipbreaker

5. Insert gauge length	6. Insert gauge width
	
	Seat size

7. Corner radius	8. Insert width																				
																					
<table border="0"> <tr> <td>M0,00</td> <td>= round</td> </tr> <tr> <td>01</td> <td>= 0,1 mm</td> </tr> <tr> <td>02</td> <td>= 0,2 mm</td> </tr> <tr> <td>04</td> <td>= 0,4 mm</td> </tr> <tr> <td>08</td> <td>= 0,8 mm</td> </tr> </table>	M0,00	= round	01	= 0,1 mm	02	= 0,2 mm	04	= 0,4 mm	08	= 0,8 mm	<table border="0"> <tr> <td>0200</td> <td>= 2,0 mm</td> </tr> <tr> <td>0300</td> <td>= 3,0 mm</td> </tr> <tr> <td>0400</td> <td>= 4,0 mm</td> </tr> <tr> <td>0500</td> <td>= 5,0 mm</td> </tr> <tr> <td></td> <td>etc.</td> </tr> </table>	0200	= 2,0 mm	0300	= 3,0 mm	0400	= 4,0 mm	0500	= 5,0 mm		etc.
M0,00	= round																				
01	= 0,1 mm																				
02	= 0,2 mm																				
04	= 0,4 mm																				
08	= 0,8 mm																				
0200	= 2,0 mm																				
0300	= 3,0 mm																				
0400	= 4,0 mm																				
0500	= 5,0 mm																				
	etc.																				

9. Version	
R	L
	

10. Insert type code, for further information please see page(s) 690-691	
FT = Chipbreaker for fine turning	FG = For lock rings
FTR/L = Right or left hand version with a specified setting angle, for parting-off	DY = For dynamic O-rings
MT = Chipbreaker for medium turning	ST = For static O-rings
MG = Chipbreaker for medium grooving	D76 = For thread undercuts
MC = Chipbreaker for medium cut-off	R = For radius
MCR/L = Right or left hand version with a specified setting angle, for parting-off	A55/A60 = For threading
GG = Chipbreaker for medium grooving	G55/G60
GS = Chipbreaker for fine grooving	ISO
MP = Chipbreaker for medium profiling	
RP = Chipbreaker for fine and medium profiling	

General ISO Turning
 Steadyline®
 MDT
 Mini-Shaft™
 Grooving
 Parting-off
 X4
 Adapters Clamping units
 Accessories and Spare parts
 Workpiece materials

Toolholders

General ISO Turning

Steadyline®

MDT

CFIR/L – Basic choice

- For external turning, profiling and grooving
- Maximum working depth 3 x the insert width (can be limited by double ended inserts)
- Size 16 – For general machining
- Size 30 – For heavy machining

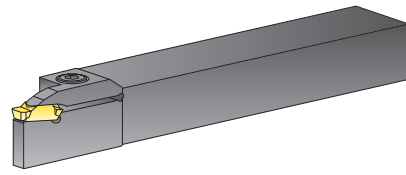
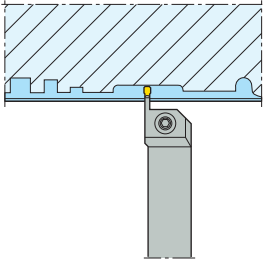

Mini-Shaft™

Grooving

Parting-off

CFMR/L – Long reach

- For external turning, profiling and grooving
- Maximum working depth 5 x the insert width
- Single ended inserts should be used (CFMR/L, CFSR/L)
- Size 16 – For general machining
- Size 28 – For general machining
- Size 30 – For heavy machining

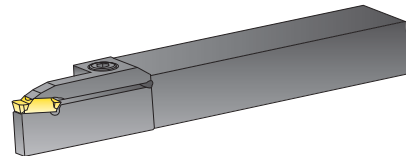
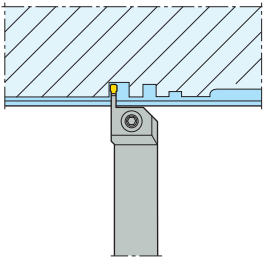

X4

Adapters
Clamping units

Accessories and
Spare parts

CFOR/L, CFPR/L, CFSR/L, CFTR/L, CFZR/L – Extra long reach, 6 x insert width up to 12,5 x insert width

- For grooving and parting-off
- Single ended inserts should be used (CFOR/L, CFPR/L, CFTR/L)
- Size 16 – For general machining
- Size 19 – For small part machining
- Size 28 – For general machining

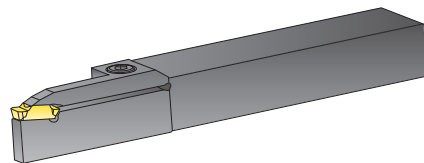
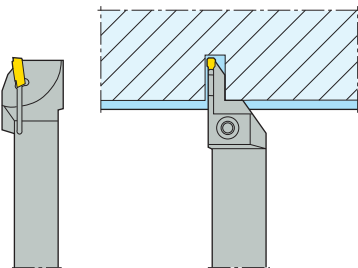

Workpiece
materials

CGIR/L, CFIR/L, CFOR/L – Axial machining

- For axial turning, profiling and grooving
- Maximum working depth 3-6 x the insert width (can be limited by double ended inserts).
- These toolholders demand that the first cut must be made between two specified diameters (see code key)
- Size 16 – For general machining
- Size 30 – For heavy machining

CGIR

CFIL

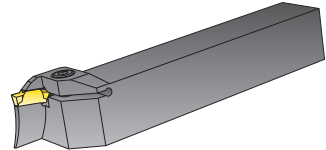
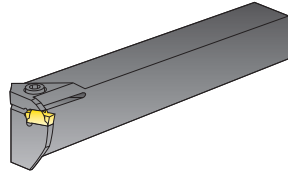
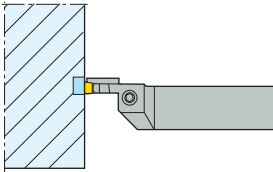

CG.IR/L – Internal machining

- For internal turning, profiling and grooving
- Maximum working depth 1-3,5 x the insert width for size 13
- Maximum working depth 3 x the insert width for size 16
- Maximum working depth 2,5-3,5 x the insert width for size 19
- For through coolant supply
- Size 13 – For machining in small bore sizes
- Size 16 – For general machining
- Size 19 – For machining in small bore size

MDT16

MDT13

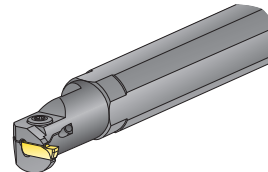
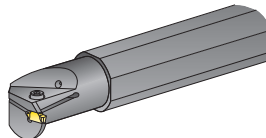
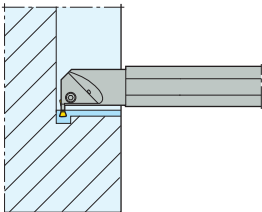

Single ended blades

- Holder with both right and left hand blade mounting available
- Size 16 – For general machining

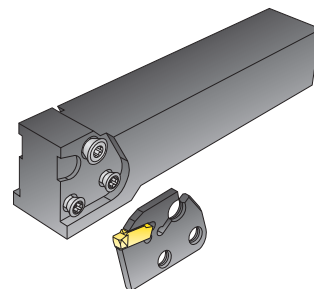
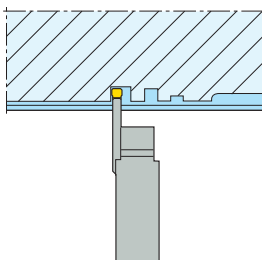

General ISO Turning

Steadyline®

MDT

Mini-Shaft™

Grooving

Parting-off

X4

Adapters
Clamping units

Accessories and
Spare parts

Workpiece
materials

General ISO Turning

Steadyline®

MDT

Mini-Shaft™

Grooving

Parting-off

X4

Adapters
Clamping units

Accessories and
Spare parts

Workpiece
materials

Double ended blades

- To be used in standard 150.10 toolblocks
- Size 16 – For parting-off

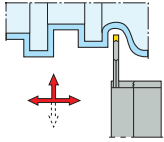

Modular holders, axial/radial

- For axial turning, profiling and grooving
- Maximum working depth 3-6 x the insert width (can be limited by double ended inserts).
- These toolholders demand that the first cut must be made between two specified diameters (see code key)
- Size 16 – For general machining
- Size 30 – For heavy machining

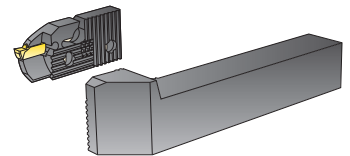
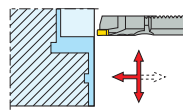
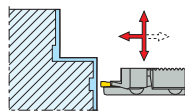
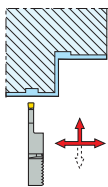

MDT – Inserts

LCMF – Basic choice

Double ended
Economy (cutting edges at both ends)
Size 13 – For machining in small bore sizes and axial machining at small diameters
Size 16 – For general machining
Size 19 – For small part machining
Size 28 – For general machining
Size 30 – For heavy machining

MDT13



MDT16
MDT30



MDT19
MDT28



LCMR

Single ended
Flexibility
Reach (full length clearance)
Size 13 – For machining in small bore sizes and axial machining at small diameters
Size 16 – For general machining
Size 30 – For heavy machining

MDT13



MDT16
MDT30



LCG.

Special applications
Standard and (customer specified) tailor made profiles
Double or single ended
With or without chipbreaker

Size 13 – For machining in small bore sizes and axial machining at small diameters
Size 16 – For general machining
Size 30 – For heavy machining



General ISO Turning

Steadyline®

MDT

Mini-Shaft™

Grooving







Parting-off



X4

Adapters
Clamping units

Accessories and
Spare parts

Workpiece
materials

General ISO Turning	FT (Fine Turning)	FT 19 and 28 (Fine Turning)
	<p>For fine turning For deep grooving</p> 	<p>For parting-off For deep grooving</p> 
Steadyline®		
MDT	MT (Medium Turning)	MG (Medium Grooving)
	<p>For medium turning For shallow grooving</p> 	<p>For medium turning For deep grooving For parting-off</p> 
Mini-Shaft™		
Grooving	MC (Medium Cut-off)	GG (Grooving Ground)
	<p>For parting-off tubes and small diameter workpieces For deep grooving</p> 	<p>Ground chipgroove For medium grooving, complement to FT for precision grooves</p> 
Parting-off		
X4	GS (Grooving Sharp)	A55/A60, G55/G60, ISO
	<p>Sharp edge For fine grooving in non-ferrous materials/superalloys Precision grooves</p> 	<p>For threading applications</p> 
Adapters Clamping units		
Accessories and Spare parts		
Workpiece materials		

MP (Medium Profiling)	RP (Round Profiling)
<p>For medium profiling For medium turning</p> 	<p>For fine and medium profiling, turning and grooving Sharp periphery ground edges For superalloys, titanium alloys and non-ferrous materials</p> 

- General ISO Turning
- Steadyline®
- MDT**
- Mini-Shaft™
- Grooving
- Parting-off
- X4
- Adapters
Clamping units
- Accessories and
Spare parts
- Workpiece
materials

- General ISO Turning
- Steadyline®
- MDT
- Mini-Shaft™
- Grooving
- Parting-off
- X4
- Adapters
Clamping units
- Accessories and
Spare parts
- Workpiece
materials

Grades		
CP200		PVD-coated, hard micrograin grade with great wear resistance, intended for grooving, parting-off and profiling of superalloys, titanium alloys and hardened steels. A more wear resistant alternative to grade 890. (Ti,Al)N + TiN
CP500		Tough versatile PVD-coated micrograin grade intended for grooving in a variety of workpiece materials. Universal choice. (Ti,Al)N + TiN
CP600		Very tough PVD-coated fine-grain grade intended for deep grooving and parting-off at low to moderate cutting speeds. Well-suited in deep grooving and in interrupted cuts. Tougher alternative to CP500. (Ti,Al)N + TiN
TGH1050		Very hard supermicrograin grade intended for partly hardened steel components as well as generally workpiece materials such as superalloys and cast-iron and due to remarkable edge toughness it also provides high performance in interrupted cuts and hard-surface removal. Ti-Al-Si-N nanolaminate coating
TGK1500		Wear-resistant, hard Duratomic® CVD-coated grade intended for grooving and profiling of grey cast iron and nodular cast iron. Ti(C,N) + Al ₂ O ₃
TGP25		A wear-resistant Duratomic® CVD-coated grade intended for grooving, turning and profiling of steels at high cutting speeds. Ti(C,N) + Al ₂ O ₃
883		Uncoated, hard grade intended for grooving, parting-off and profiling of superalloys, titanium alloys, hardened steels and non-ferrous materials.
890		Uncoated, very hard micrograin grade intended for grooving and profiling of superalloys, titanium alloys, hardened steels and non-ferrous materials. More wear resistant alternative to grade 883.

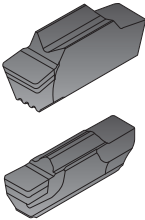
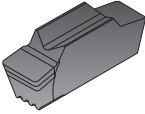
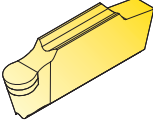
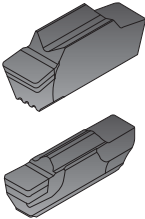
Grades, PCBN	
<p>CBN010</p> 	<p>Single-ended inserts with brazed tip, intended for hardened steels and Ni-based superalloys.</p> <p>Composition: 50% cBN content grade with an average grain size of 2 µm and a TiC ceramic binder.</p> <p>Coating: No coating.</p>
<p>CBN170</p> 	<p>Single-ended inserts with brazed tip, intended for Ni-based superalloys.</p> <p>Composition: 65% cBN content grade with an average grain size of 2 µm and a TiCN+SiCw ceramic binder.</p> <p>Coating: No coating.</p>
<p>CBN170C</p> 	<p>Single-ended inserts with brazed tip, intended for Ni-based superalloys.</p> <p>Composition: 65% cBN content grade with an average grain size of 2 µm and a TiCN+SiCw ceramic binder.</p> <p>Coating: (Ti,Si)N</p>
<p>CBN200</p> 	<p>Single-ended inserts with brazed tip, intended for perlitic cast iron and hardened steels.</p> <p>Composition: 90% cBN content grade with an average grain size of 3-6 µm and a Al ceramic binder.</p> <p>Coating: No coating.</p>

General ISO Turning

Steadyline®

MDT

Mini-Shaft™

Grooving

Parting-off

X4

Adapters
Clamping units

Accessories and
Spare parts

Workpiece
materials

Application recommendations

“Easy conditions: pre-machined surface, shallow grooves etc.

Difficult conditions: raw surface, deep grooves etc.”

	To centre		Tube	
	Easy conditions	Difficult conditions	Easy conditions	Difficult conditions
General ISO Turning	FT TGP25	MC CP600	MT TGP25	MT TGP25
Steadyline®	FT CP500	MC CP600	MT TGP25	MT TGP25
MDT	MT TGI1500	MT CP500	MT TGI1500	MT TGP25
Mini-Shaft™	MT 883	MT CP500	MT 883	MT CP500
	MT 883	MT CP500	MT 883	MT CP500
	S-LF CBN 10 CBN 010	S-LF CBN200	S-LF CBN 10 CBN 010	S-LF CBN200

MDT Grades – Secolor







The chart below shows application areas for grades available in the MDT system. The black areas in the chart indicate a grade's main ISO application groups and the white areas indicate other supplementary application groups.

Indicative ISO classification of the grades

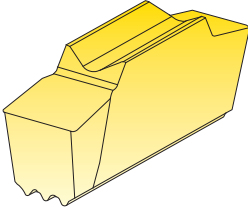
Steel P
Stainless steel M
Cast iron K
Non-ferrous metals N
Superalloys and titanium S
Hard materials H

	P					M					K					N				S				H					
	P01	P10	P20	P30	P40	P50	M01	M10	M20	M30	M40	K01	K10	K20	K30	K40	N01	N10	N20	N30	S01	S10	S20	S30	H01	H10	H20	H30	H40
TGP25																													
TGK1500																													
TGH1050																													
CP200																													
CP500																													
CP600																													
890																													
883																													
CBN010																													
CBN170																													
CBN170C																													
CBN200																													

Inserts for standard grooves

Standard programme				
Double-ended LCGA (MDT13) Single-ended LCGN (MDT16)				
FG – For locking rings	DY – For dynamic O-rings	R – For full radius grooving	D76 – For thread undercuts	ST – For static O-rings
				

Remember to check the toolholder clearance before using these inserts.

Special applications

Standard programme

- Tailor-made inserts
- LCG.

Special inserts can easily be produced in the styles below.

They are made from blanks, single or double ended, with or without chipbreaker.

(Available as Custom Design at your local Seco website or contact your Seco representative for a special order form to define the required insert.)

Style A

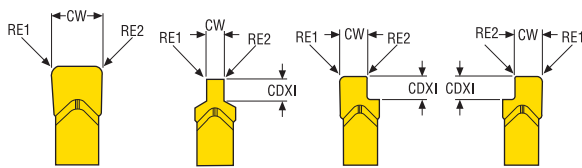

Standard or special widths with corner radii

Style B

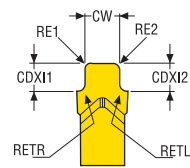

Standard or special widths with corner and crest radii

Style C

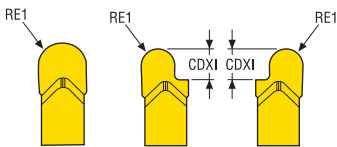

Standard or special widths with full radius

Style D

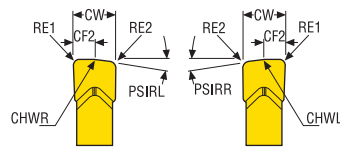

Standard or special widths with front angle and corner radii

Style E

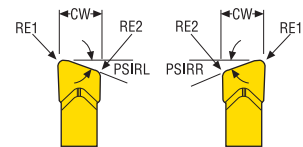

Special widths with front angle and corner radii

Style F

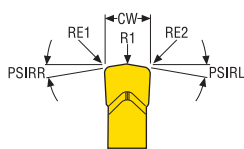

Special widths with double front angles and corner radii

Style G

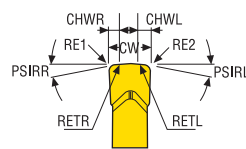

Special widths with double front angles and corner radii

Style J

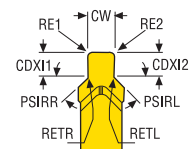

Special widths with radii and chamfers

Style K

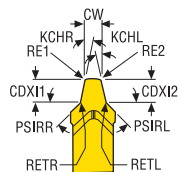

Special widths with radii, chamfers and angles

Remember to check the toolholder clearance before using these inserts.

Principles

Principles

During turning the axial forces deflect the tool generating a necessary trailing edge clearance angle.

This angle depends on

- Feed
- Depth of cut
- Tool overhang
- Insert width
- Cutting speed
- Workpiece material

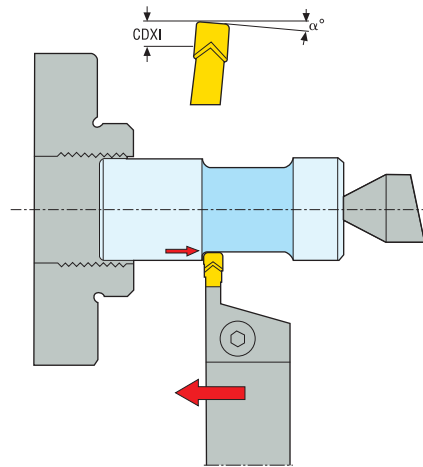

The deflection arising during turning causes a minor change of the actual tool length. This influences the received diameter on the workpiece.

The exact amount can be figured by running a test piece. First make a groove and then a turning operation to the same diameter with the selected cutting data. Compare the two different diameters and use the formula to calculate a compensation measure.

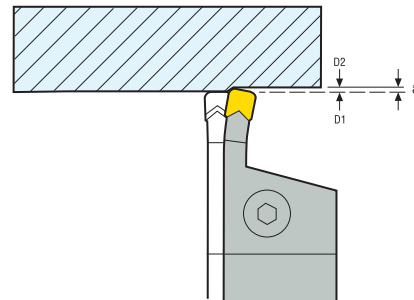

$$\delta = \frac{D1 - D2}{2}$$

- General ISO Turning
- Steadyline®
- MDT**
- Mini-Shaft™
- Grooving
- Parting-off
- X4
- Adapters Clamping units
- Accessories and Spare parts
- Workpiece materials

Technical tips

Use the following technical tips for a favourable cutting process considering chipbreaking, cutting forces and tool life.

Machining a deep groove

- Make a central groove to half of the total depth.
- Make infeeds at both sides to the same depth.
- Machine a central groove to full depth.
- Make infeeds at both sides to the full depth.
- Always outfeed, do not rapid traverse.

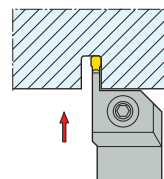
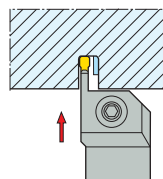
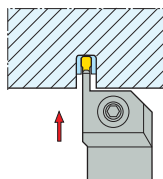
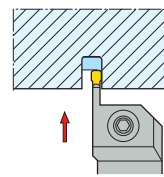
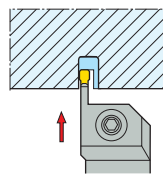
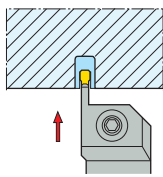

Roughing a recess

If the depth is larger than the width

- Use successive infeeds to required diameter.
- Increment a distance of the insert width – 2 x the insert corner radius to get a flat bottom surface.
- Always outfeed, do not use rapid traverse.

If the width is larger than the depth.

- Start with an infeed at one end.
- Use successive alternating turning with infeeds at the end.
- Release the tool deflection after turning before infeeding (reverse feed and reposition the insert before infeed – 0,1 mm).

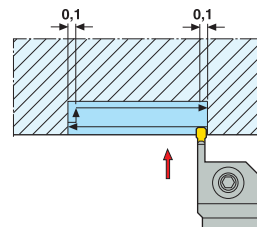
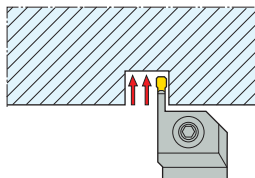

Finishing a recess with corner radius or chamfer

- Machine the face down to the end point of the radius or chamfer.
- Make a groove to the required depth at the end point of the radius or chamfer.
- Machine down to the end point of the radius or chamfer.
- Machine the radius or chamfer.
- Machine the diameter until the end point of the radius or chamfer is reached (remember to compensate for the deflection).
- Machine the radius or chamfer.

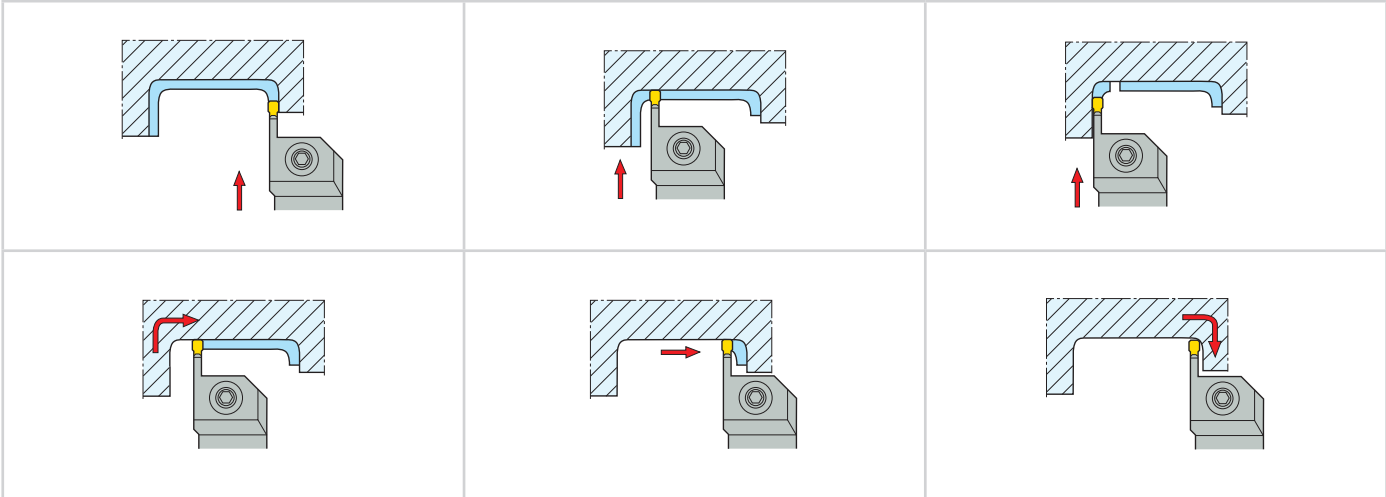

Machining a large corner radius or chamfer

- Make a groove to the required depth at the end point of the radius or chamfer.
- Machine the face down to the end point of the radius or chamfer.
- Machine the radius or chamfer.
- Continue with turning starting from the groove (remember to compensate for the deflection).

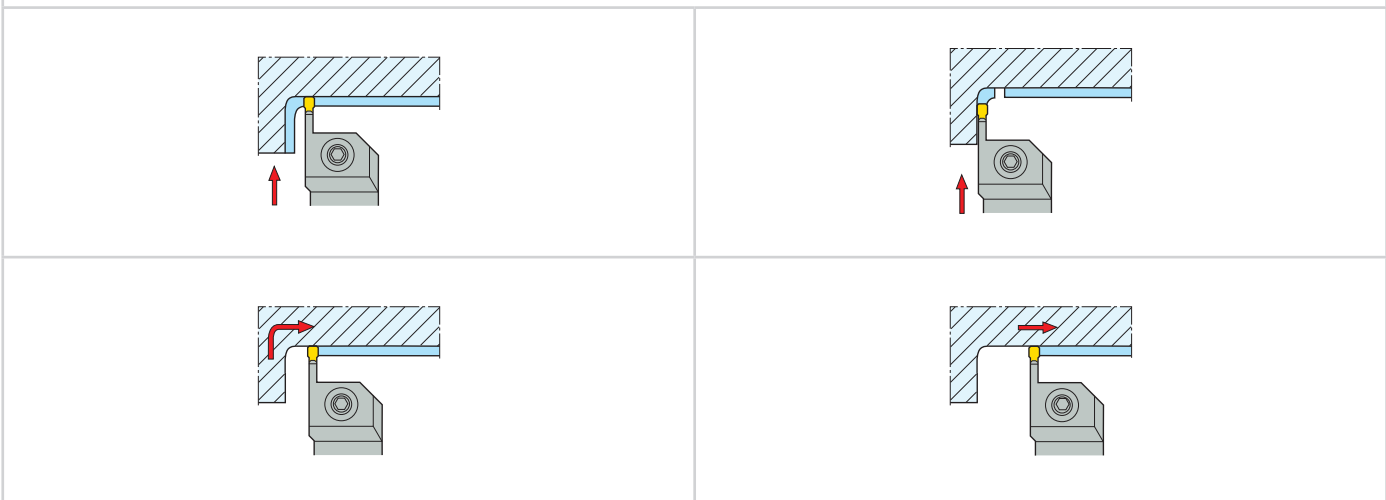

General ISO Turning

Steadyline®

MDT

Mini-Shaft™

Grooving

Parting-off

X4

Adapters
Clamping units

Accessories and
Spare parts

Workpiece
materials

General ISO Turning

Eliminating a hanging ring

- Turning towards the end of a component or towards a recess sometimes produces a hanging ring.
- To avoid this
- Stop the turning operation 1,0–1,5 mm before the end of the component or the recess.
 - Plunge down to the turned diameter.

Steadyline®

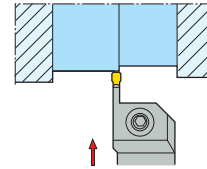
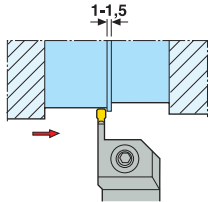

MDT

Profiling with round inserts

- The cutting depth should be maximum 0,4 x the insert diameter.
- There is no requirement to generate a trailing edge clearance angle as the geometry will provide that.

Mini-Shaft™

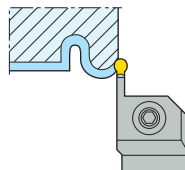

Grooving

Parting-off

Roughing a recess with round inserts

- Machine the face down to the end point of the radius or chamfer.
- Track around the radius.
- Turn to the end point of the radius or chamfer on the other side.
- Machine down the other side and track around the radius or chamfer.

X4

Adapters
Clamping units

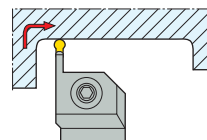
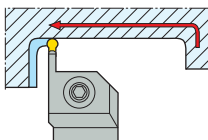

Accessories and
Spare parts

Workpiece
materials

Finishing a recess with round inserts

- Make the cut in one continuous movement.
- Notice the maximum cutting depth allowed during outfeeding (see table).

D mm	a _p mm
2	0,12
3	0,15
4	0,20
5	0,22
6	0,25
8, 10	0,40

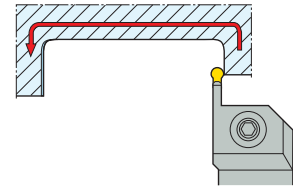
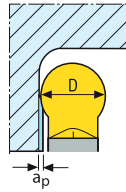

Axial machining

- In axial grooving operations the tool must be adapted to the radius of the groove.
- The toolholder code tells the maximum and minimum diameters that can be handled (see code key).
- The diameter measured on the outside of the blade (INPLX) determines the largest diameter of initial plunge.
- The diameter measured on the inside of the blade (INPLM) determines the smallest diameter of initial plunge.
- This applies to the initial groove only. Changing to turning means no general restrictions besides collision risk if machining towards centre.

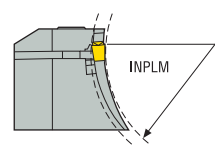
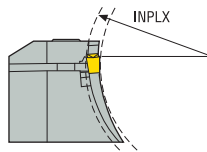
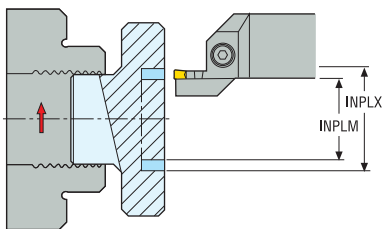

Internal machining

- Generally the same technique as for external machining should be used.
- In blind holes problems can occur with chip evacuation. To avoid that start with making a groove at the inner wall and turn towards the outside.

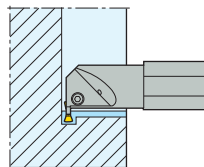

General ISO Turning

Steadyline®

MDT

Mini-Shaft™

Grooving

Parting-off

X4

Adapters
Clamping units

Accessories and
Spare parts

Workpiece
materials

Modular holders

Calculation of dimensions after mounting	
<p>Example, left hand version (L):</p> <ul style="list-style-type: none"> – Blade holder GL (alternative Seco-Capto™ GL). – Blade type V21-C.R130.L.. <p>LF = LF holder + WF blade WF = WF holder + LF blade</p>	
<p>Example, right hand version (R):</p> <ul style="list-style-type: none"> – Blade holder GR (alternative Seco-Capto™ GR). – Blade type V21-C.L130.R.. <p>LF = LF holder + WF blade WF = WF holder + LF blade</p>	
<p>Example, right hand version (R):</p> <ul style="list-style-type: none"> – Blade holder FR (alternative Seco-Capto™ FR). – Blade type V21-C.R130.L.. <p>LF = LF holder + LF blade WF = WF holder + WF blade</p>	
<p>Example, left hand version (L):</p> <ul style="list-style-type: none"> – Blade holder FL (alternative Seco-Capto™ FL). – Blade type V21-C.L130.R.. <p>LF = LF holder + LF blade WF = WF holder + WF blade</p>	

General ISO Turning
 Steadyliner®
 MDT
 Mini-Shaft™
 Grooving
 Parting-off
 X4
 Adapters
 Clamping units
 Accessories and
 Spare parts
 Workpiece
 materials

Calculation of dimensions after mounting	
<p>Example, left hand version (L):</p> <ul style="list-style-type: none"> – Blade holder FL (alternative Seco-Capto™ FL). – Blade type V21-C.L130.L.. <p>LF = LF holder + LF blade WF = WF holder + WF blade</p>	
<p>Example, right hand version (R):</p> <ul style="list-style-type: none"> – Blade holder FR (alternative Seco-Capto™ FR). – Blade type V21-C.R130.R.. <p>LF = LF holder + LF blade WF = WF holder + WF blade</p>	
<p>Example, left hand version (L):</p> <ul style="list-style-type: none"> – Blade holder A..FL (alternative Seco-Capto™ A..FL). – Blade type V21-C.L130.L.. <p>LF = LF holder + LF blade WF = WF holder + WF blade</p>	
<p>Example, right hand version (R):</p> <ul style="list-style-type: none"> – Blade holder A..FR (alternative Seco-Capto™ A..FR). – Blade type V21-C.R130.R.. <p>LF = LF holder + LF blade WF = WF holder + WF blade</p>	
<p>Bars A25R-F... can enter a minimum diameter DCINN ≥ 25 mm. Bars A32S-F... can enter a minimum diameter DCINN ≥ 32 mm.</p>	

General ISO Turning
Steadyline®
MDT
Mini-Shaft™
Grooving
Parting-off
X4
Adapters Clamping units
Accessories and Spare parts
Workpiece materials

General ISO Turning

Steadyline®

MDT

Mini-Shaft™

Grooving

Parting-off

X4

Adapters
Clamping units

Accessories and
Spare parts

Workpiece
materials

Calculation of dimensions after mounting

Example, left hand version (L):

- Blade holder SL (alternative Seco-Capto™ SL).
- Blade type V21-C.R... or V21-C.R...L..
- $LF = LF \text{ holder} + 0,71 \times (WF \text{ blade} + LF \text{ blade})$
- $WF = WF \text{ holder} + 0,71 \times (LF \text{ blade} - WF \text{ blade})$

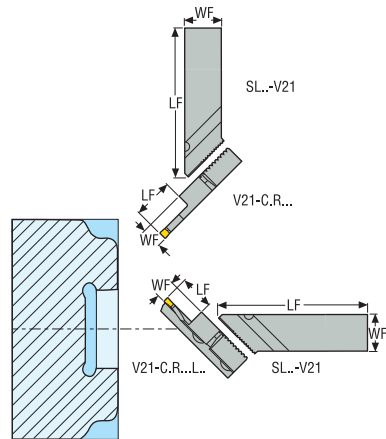

Example, right hand version (R):

- Blade holder SR (alternative Seco-Capto™ SR).
- Blade type V21-C.L... or V21-C.L...R..
- $LF = LF \text{ holder} + 0,71 \times (WF \text{ blade} + LF \text{ blade})$
- $WF = WF \text{ holder} + 0,71 \times (LF \text{ blade} - WF \text{ blade})$

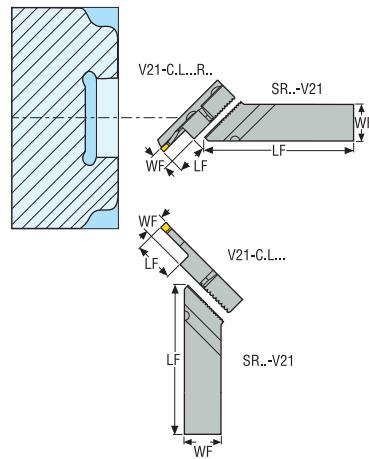

Dimensions relevant for toolholder use

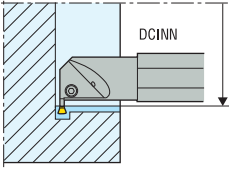
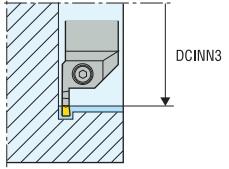
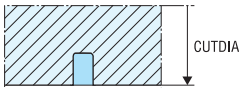
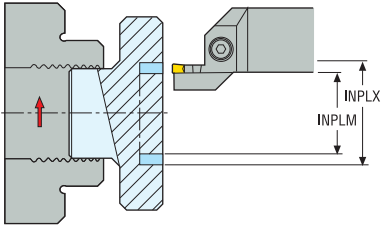
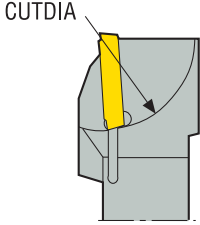
<p>DCINN (D_m min)</p> 	<p>DCINN3 (D_{m2})</p> 
<p>CUTDIA (D_{max})</p> 	<p>INPLM/INPLX</p> 
<p>CUTDIA ..RB</p> 	

General ISO Turning

Steadyline®

MDT

Mini-Shaft™

Grooving

Parting-off

X4

Adapters
Clamping units

Accessories and
Spare parts

Workpiece
materials

Machining problems

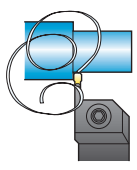
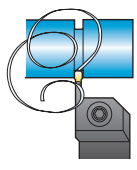
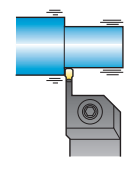
Machining problems	
<p>Chipbreaking problems/ turning</p> 	<p>Increase feed rate or cutting depth. Use narrower insert with smaller radius.</p>
<p>Chipbreaking problems/ grooving</p> 	<p>Reduce the cutting speed. Increase the feed rate. Use interrupted feed.</p>
<p>Vibrations</p> 	<p>Change the cutting speed. Increase the feed rate. Reduce the cutting depth. Improve the stability of the tool and workpiece. Select an insert with smaller radius.</p>

General ISO Turning

Steadyline®

MDT

Mini-Shaft™

Grooving

Parting-off

X4

Adapters
Clamping units

Accessories and
Spare parts

Workpiece
materials

Tool life problems

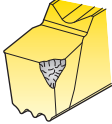
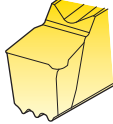
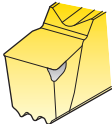
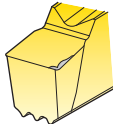
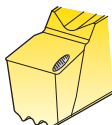
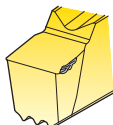
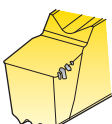
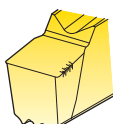
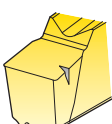
Tool life problems			
<p>Breakage</p> 	<p>Reduce the feed rate. Reduce the cutting depth. Select a tougher grade. Select an insert with larger radius.</p>	<p>Plastic deformation</p> 	<p>Reduce the cutting speed. Reduce the feed rate. Use coolant. Select a more wear resistant grade. Select an insert with larger radius.</p>
<p>Rapid flank wear</p> 	<p>Reduce the cutting speed.</p>	<p>Built-up edge</p> 	<p>Increase the cutting speed. Increase the feed rate. Do not use coolant.</p>
<p>Rapid crater wear</p> 	<p>Reduce the cutting speed. Reduce the feed rate. Use coolant. Select a more wear resistant grade.</p>	<p>Chip hammering</p> 	<p>Change the feed rate. Change the cutting depth.</p>
<p>Chipping</p> 	<p>Increase the cutting speed. Reduce the feed rate. Select a tougher grade.</p>	<p>Comb cracks</p> 	<p>Reduce the cutting speed. Reduce the feed rate. Use abundant coolant flow or no coolant at all.</p>
<p>Notch wear</p> 	<p>Reduce the cutting speed. Reduce the feed rate.</p>		

General ISO Turning

Steadyline®

MDT

Mini-Shaft™

Grooving

Parting-off





X4

Adapters and Clamping units

Accessories and Spare parts

Workpiece materials

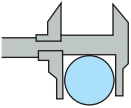
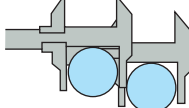
Workpiece out of tolerance

Workpiece out of tolerance				
General ISO Turning Steadyline® MDT Mini-Shaft™ Grooving Parting-off X4 Adapters Clamping units Accessories and Spare parts Workpiece materials	Poor surface finish 	Reduce the feed rate. Increase the cutting speed. Reduce the cutting depth. Use coolant. Improve the stability of the tool and workpiece.	Inaccurate square facing 	Final facing should be made as radial machining from outside to centre.
	Diameter out of tolerance 	Check the tool length compensation measure. Reduce the cutting speed. Select a more wear resistant grade.	Repeatability problems 	Keep machining conditions constant. Check the insert wear.
	Diameter variation 	After grooving the tool must be retracted in accordance with the compensation measurement before proceeding with turning. Keep machining conditions constant during turning operation.		

Working depths

These working depths can be limited when using double ended inserts because of their design.

- L...13 = CDXI max 11
- L...16 = CDXI max 14
- L...19 = CDXI max 16
- L...28 = CDXI max 26
- L...30 = CDXI max 28

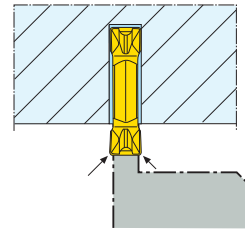

Torque values for clamping screws

Screw	Nm
L85011-T15P	5,0
L85012-T15P	5,0
L86015-T20P	6,0
MC6S4..	4,0
MC6S5..	6,0
TCEI04..	3,5
TCEI05..	6,0
TCEI06..	8,0
TCEI08..	10,0
TCEI10..	15,0

Torque keys, please see page(s) 1004-1005.

General recommendations

- Use medium to high feeds for general grooving.
- Use medium to low feeds for precision grooving.
- Always use reverse feed instead of rapid traverse out of grooves.
- Do not use too low cutting depths and feed rates for finishing and semi-finishing turning operations.
- The appropriate deflection must be achieved. Minimum cutting depths and feed rates are shown in the table below.
- When profiling with round inserts do not use cutting depths over 0,4 x the insert diameter.
- Lower the cutting data when using holders with reach $CDX \geq 5 \times CW$ because the extra length makes them deflect more.
- Maximum overhang with CGGR/L holders should be 3 x the tool diameter.

Minimum cutting depth (a_p) and feed rate (f)

Inserts	Min a_p (mm)	Min f (mm)	Inserts	Min a_p (mm)	Min f (mm)
2-FT	0,15	0,04	5-FT	0,5	0,09
3-FT	0,3	0,05	5-MT	0,5	0,18
3-MT	0,3	0,10	5-MG	0,5	0,10
3-MG	0,5	0,05	5-MC	0,5	0,05
3-MC	0,5	0,05	6-FT	0,6	0,10
4-FT	0,4	0,08	6-MT	0,6	0,20
4-MT	0,4	0,15	6-MG	0,6	0,10
4-MG	0,5	0,10	6-MC	0,5	0,10
4-MC	0,5	0,05	8-FT	0,7	0,25

Cutting depth and feed rate recommendations

MDT 13

Recommended cutting depths and feed rates for the different insert geometries are found in the charts below.

Geometry -FT

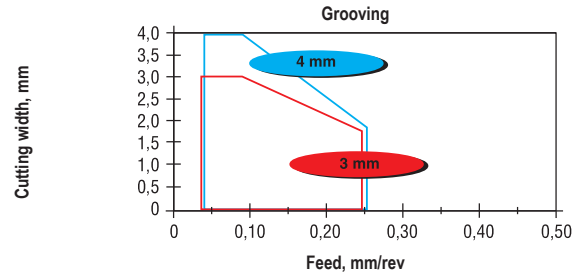
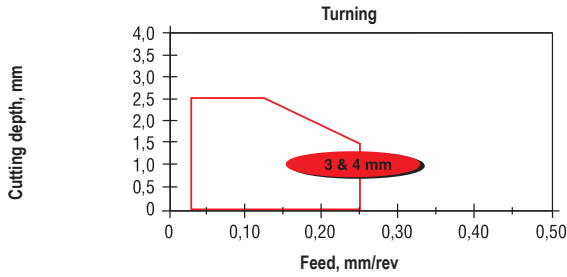

Geometry -MC

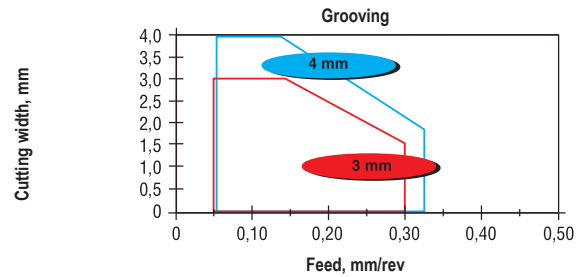
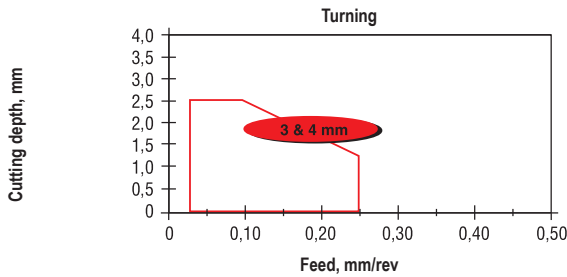

Geometry -MP

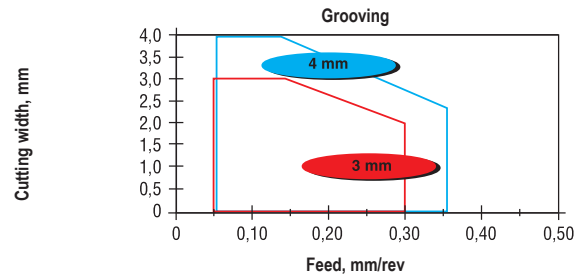
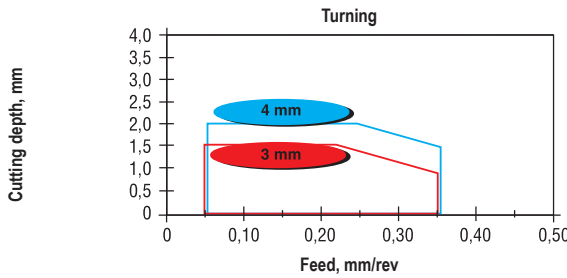

MDT 16 and 30

Recommended cutting depths and feed rates for the different insert geometries are found in the charts below.

Geometry -FT

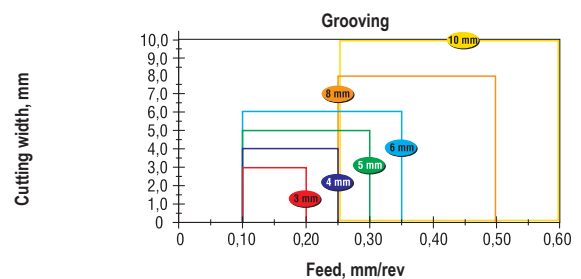
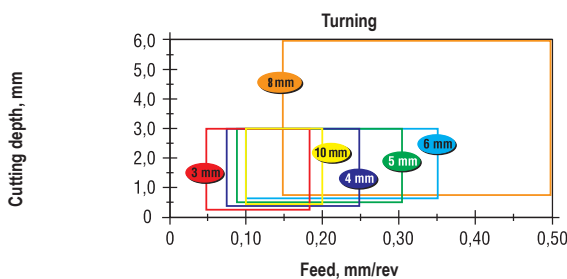

General ISO Turning
Steadyline®
MDT
Mini-Shaft™
Grooving
Parting-off
X4
Adapters and Clamping units
Accessories and Spare parts
Workpiece materials

LCGF..-RP

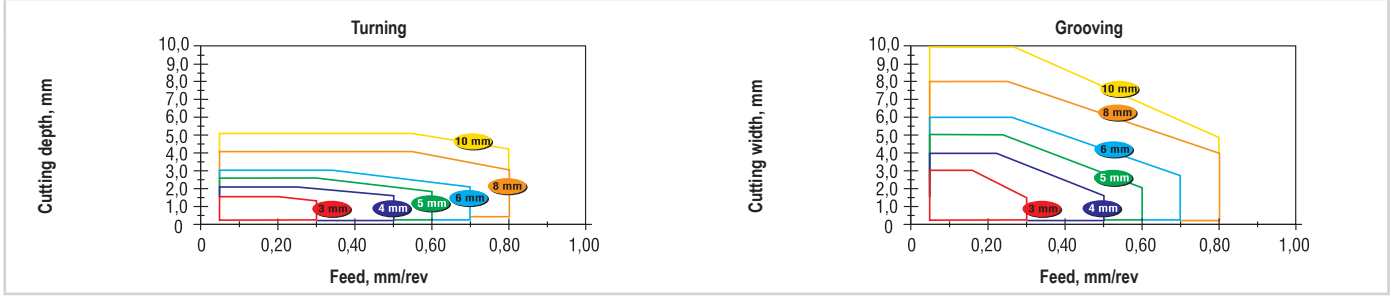

Geometry -MC

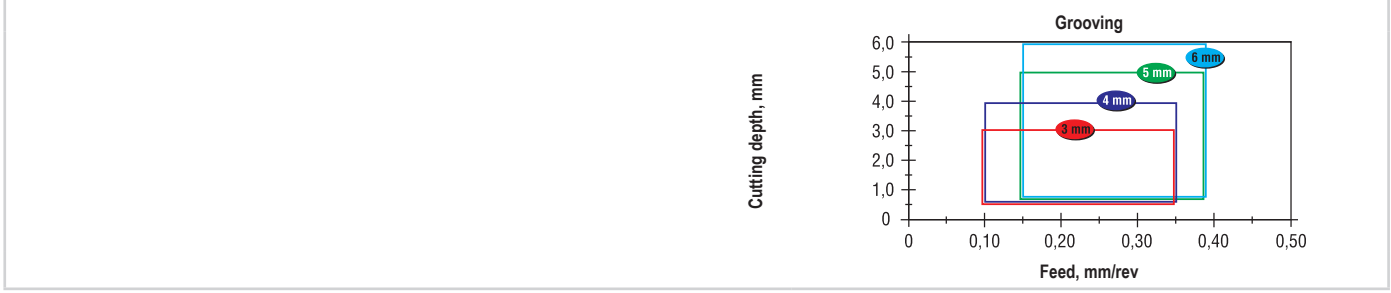

Geometry -MG

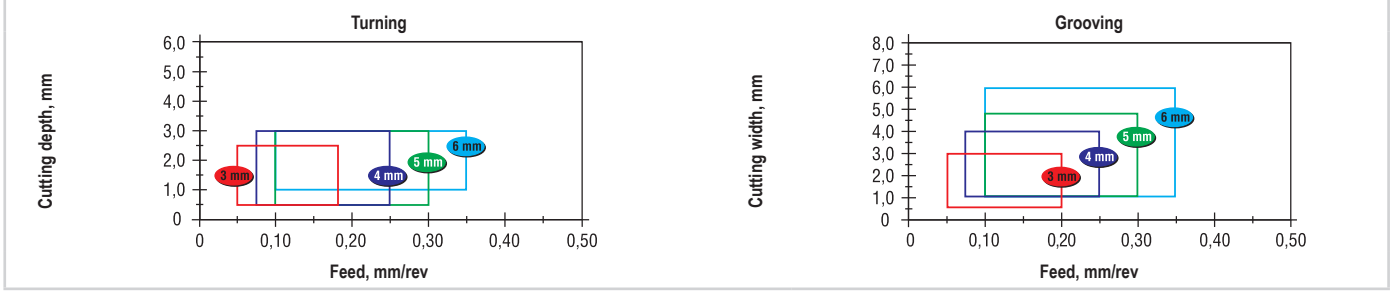

Geometry -MP

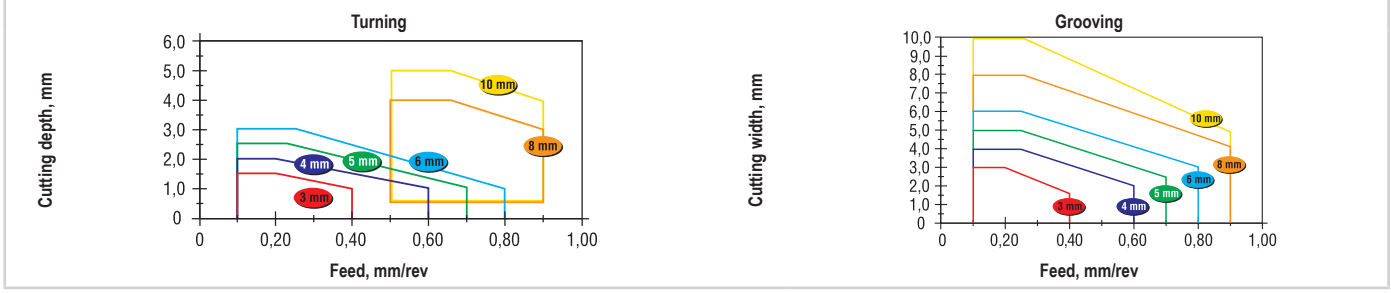

Geometry -MT

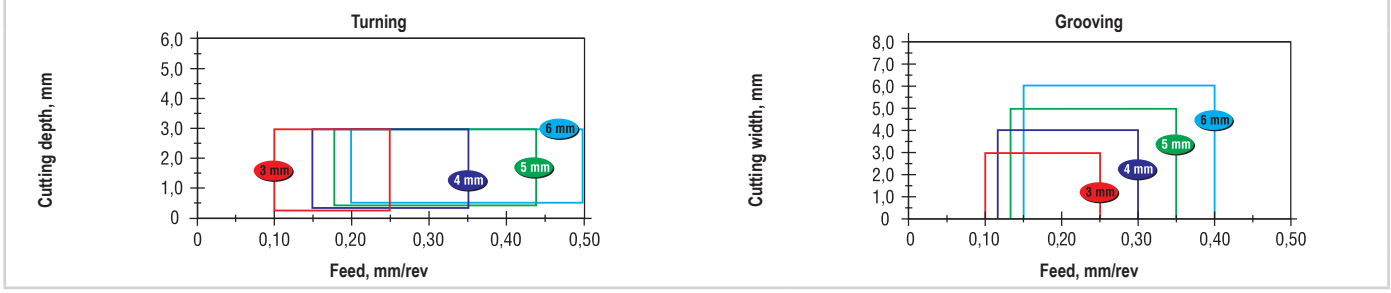

- General ISO Turning
- Steadyline®
- MDT
- Mini-Shaft™
- Grooving
- Parting-off
- X4
- Adapters
Clamping units
- Accessories and
Spare parts
- Workpiece
materials

MDT 19 and 28

Recommended cutting depths and feed rates for the different insert geometries are found in the charts below.

LCMF..-FT

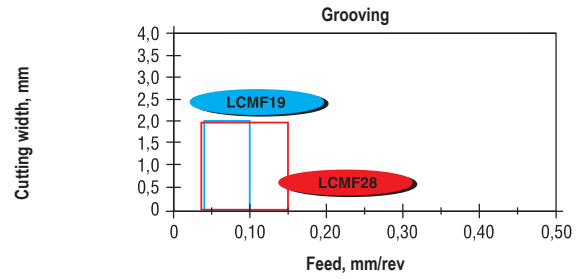
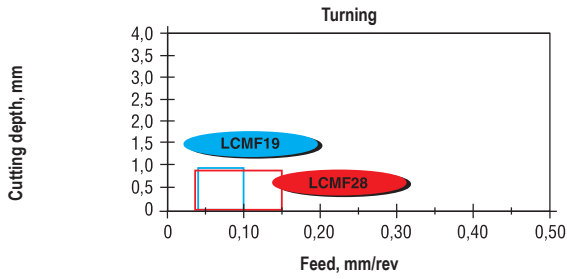

LCMF..-MP

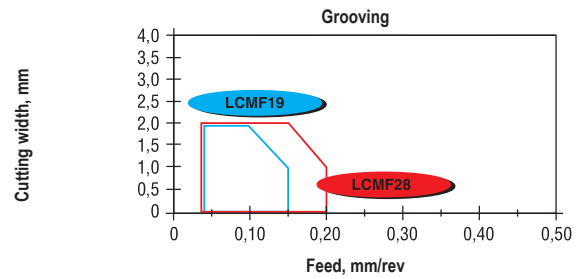
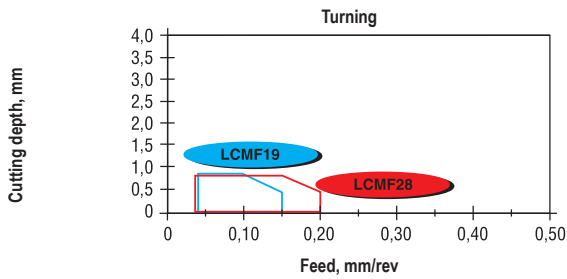

General ISO Turning

Steadyline®

MDT

Mini-Shaft™

Grooving

Parting-off

X4

Adapters and Clamping units

Accessories and Spare parts

Workpiece materials

Grade CP500

SMG		CW = 2 CW = 0.079		CW = 3 CW = 0.118		CW = 4 CW = 0.157		CW = 5-6 CW = 0.197-0.236		CW = 8-10 CW = 0.315-0.394	
		f	V _c	f	V _c	f	V _c	f	V _c	f	V _c
P1	-FT CP500	0,085	235	0,16	185	0,19	175	0,26	150	0,36	130
		0.0034	770	0.0065	610	0.0075	570	0.010	490	0.014	425
P2	-FT CP500	0,085	230	0,16	180	0,19	170	0,26	145	0,36	125
		0.0034	750	0.0065	590	0.0075	560	0.010	475	0.014	410
P3	-FT CP500	0,085	200	0,15	160	0,18	150	0,25	130	0,34	110
		0.0034	660	0.0060	520	0.0070	490	0.010	425	0.013	360
P4	-FT CP500	0,080	175	0,15	140	0,18	130	0,24	115	0,34	100
		0.0032	570	0.0060	460	0.0070	425	0.0095	375	0.013	330
P5	-FT CP500	0,080	170	0,14	140	0,18	125	0,24	110	0,34	95
		0.0032	560	0.0055	460	0.0070	410	0.0095	360	0.013	310
P6	-FT CP500	0,080	190	0,14	155	0,17	145	0,24	125	0,32	110
		0.0032	620	0.0055	510	0.0065	475	0.0095	410	0.013	360
P7	-FT CP500	0,080	180	0,14	145	0,17	135	0,24	115	0,32	100
		0.0032	590	0.0055	475	0.0065	445	0.0095	375	0.013	330
P8	-FT CP500	0,085	165	0,15	135	0,18	125	0,25	110	0,34	95
		0.0034	540	0.0060	445	0.0070	410	0.010	360	0.013	310
P11	-FT CP500	0,080	175	0,14	140	0,17	130	0,24	115	0,32	100
		0.0032	570	0.0055	460	0.0065	425	0.0095	375	0.013	330
P12	-FT CP500	0,055	115	0,10	95	0,12	85	0,16	80	0,22	70
		0.0022	375	0.0040	310	0.0048	280	0.0065	260	0.0085	230
M1	-FT CP500	0,085	265	0,16	200	0,19	170	0,26	125	0,36	80
		0.0034	870	0.0065	660	0.0075	560	0.010	410	0.014	260
M2	-FT CP500	0,080	215	0,14	175	0,18	145	0,24	110	0,34	70
		0.0032	710	0.0055	570	0.0070	475	0.0095	360	0.013	230
M3	-FT CP500	0,065	165	0,12	145	0,14	130	0,19	100	0,26	75
		0.0026	540	0.0048	475	0.0055	425	0.0075	330	0.010	245
M4	-FT CP500	0,055	120	0,10	115	0,12	105	0,17	85	0,24	60
		0.0022	395	0.0040	375	0.0048	345	0.0065	280	0.0095	195
M5	-FT CP500	0,055	100	0,10	95	0,12	90	0,17	70	0,24	50
		0.0022	330	0.0040	310	0.0048	295	0.0065	230	0.0095	165
K1	-FT CP500	0,085	215	0,16	165	0,19	150	0,26	135	0,36	115
		0.0034	710	0.0065	540	0.0075	490	0.010	445	0.014	375
K2	-FT CP500	0,080	190	0,14	145	0,18	125	0,24	105	0,34	85
		0.0032	620	0.0055	475	0.0070	410	0.0095	345	0.013	280
K3	-FT CP500	0,080	160	0,14	120	0,18	105	0,24	90	0,34	70
		0.0032	520	0.0055	395	0.0070	345	0.0095	295	0.013	230
K4	-FT CP500	0,080	150	0,14	115	0,18	100	0,24	85	0,34	70
		0.0032	490	0.0055	375	0.0070	330	0.0095	280	0.013	230
K5	-FT CP500	0,070	95	0,13	70	0,16	65	0,22	55	0,30	44
		0.0028	310	0.0050	230	0.0065	215	0.0085	180	0.012	145
K6	-FT CP500	0,080	135	0,14	105	0,18	95	0,24	85	0,34	75
		0.0032	445	0.0055	345	0.0070	310	0.0095	280	0.013	245
K7	-FT CP500	0,070	120	0,13	90	0,16	80	0,22	70	0,30	55
		0.0028	395	0.0050	295	0.0065	260	0.0085	230	0.012	180
N11	-FT CP500	0,11	140	0,20	110	0,25	100	0,34	85	0,46	75
		0.0044	460	0.0080	360	0.010	330	0.013	280	0.018	245
S1	-FT CP500	0,055	29	0,10	24	0,12	22	0,17	20	0,24	17
		0.0022	95	0.0040	80	0.0048	70	0.0065	65	0.0095	55
S2	-FT CP500	0,055	25	0,10	21	0,12	19	0,17	17	0,24	15
		0.0022	80	0.0040	70	0.0048	60	0.0065	55	0.0095	49
S3	-FT CP500	0,050	22	0,095	18	0,11	17	0,15	15	0,22	13
		0.0020	70	0.0038	60	0.0044	55	0.0060	49	0.0085	43

General ISO Turning

Steadyline®

MDT

Mini-Shaft™

Grooving

Parting-off

X4

Adapters
Clamping units

Accessories and
Spare parts

Workpiece
materials

Grade TGP25

SMG		CW = 3 CW = 0.118		CW = 4 CW = 0.157		CW = 5 CW = 0.197		CW = 6 CW = 0.236		CW = 8-10 CW = 0.315-0.394	
		f	v _c	f	v _c	f	v _c	f	v _c	f	v _c
P1	-FT TGP25	0,16	380	0,19	345	0,24	300	0,26	285	0,36	225
		0.0065	1250	0.0075	1125	0.0095	980	0.010	940	0.014	740
P2	-FT TGP25	0,16	370	0,19	335	0,24	290	0,26	275	0,36	220
		0.0065	1225	0.0075	1100	0.0095	950	0.010	900	0.014	720
P3	-FT TGP25	0,15	270	0,18	245	0,22	225	0,25	215	0,34	185
		0.0060	890	0.0070	800	0.0085	740	0.010	710	0.013	610
P4	-FT TGP25	0,15	290	0,18	260	0,22	230	0,24	220	0,34	175
		0.0060	950	0.0070	850	0.0085	750	0.0095	720	0.013	570
P5	-FT TGP25	0,14	230	0,18	210	0,22	190	0,24	180	0,34	155
		0.0055	750	0.0070	690	0.0085	620	0.0095	590	0.013	510
P6	-FT TGP25	0,14	320	0,17	290	0,22	250	0,24	235	0,32	190
		0.0055	1050	0.0065	950	0.0085	820	0.0095	770	0.013	620
P7	-FT TGP25	0,14	245	0,17	225	0,22	200	0,24	195	0,32	170
		0.0055	800	0.0065	740	0.0085	660	0.0095	640	0.013	560
P8	-FT TGP25	0,15	225	0,18	210	0,22	190	0,25	180	0,34	155
		0.0060	740	0.0070	690	0.0085	620	0.010	590	0.013	510
P11	-FT TGP25	0,14	235	0,17	220	0,22	195	0,24	190	0,32	165
		0.0055	770	0.0065	720	0.0085	640	0.0095	620	0.013	540
P12	-FT TGP25	0,10	155	0,12	145	0,15	135	0,16	130	0,22	115
		0.0040	510	0.0048	475	0.0060	445	0.0065	425	0.0085	375
M1	-MC TGP25	0,16	290	0,19	265	0,24	225	0,26	205	0,36	145
		0.0065	950	0.0075	870	0.0095	740	0.010	670	0.014	475
M2	-MC TGP25	0,14	240	0,18	220	0,22	190	0,24	180	0,34	125
		0.0055	790	0.0070	720	0.0085	620	0.0095	590	0.013	410
M3	-MC TGP25	0,12	185	0,14	180	0,17	170	0,19	160	0,26	125
		0.0048	610	0.0055	590	0.0065	560	0.0075	520	0.010	410
M4	-MC TGP25	0,10	140	0,12	140	0,15	135	0,17	125	0,24	100
		0.0040	460	0.0048	460	0.0060	445	0.0065	410	0.0095	330
K1	-MT TGP25	0,18	260	0,22	230	0,25	215	0,28	200	0,38	160
		0.0070	850	0.0085	750	0.010	710	0.011	660	0.015	520
K2	-MT TGP25	0,16	175	0,19	165	0,24	150	0,25	145	0,34	125
		0.0065	570	0.0075	540	0.0095	490	0.010	475	0.013	410
K3	-MT TGP25	0,16	150	0,19	140	0,24	125	0,25	125	0,34	105
		0.0065	490	0.0075	460	0.0095	410	0.010	410	0.013	345
K4	-MT TGP25	0,16	140	0,19	135	0,24	120	0,25	120	0,34	105
		0.0065	460	0.0075	445	0.0095	395	0.010	395	0.013	345
K5	-MT TGP25	0,15	85	0,18	80	0,20	75	0,22	75	0,30	65
		0.0060	280	0.0070	260	0.0080	245	0.0085	245	0.012	215
K6	-MT TGP25	0,16	165	0,19	155	0,24	135	0,25	130	0,34	105
		0.0065	540	0.0075	510	0.0095	445	0.010	425	0.013	345
K7	-MT TGP25	0,15	110	0,18	105	0,20	100	0,22	95	0,30	85
		0.0060	360	0.0070	345	0.0080	330	0.0085	310	0.012	280

General ISO Turning

Steadyline®

MDT

Mini-Shaft™

Grooving

Parting-off

X4

Adapters
Clamping units

Accessories and
Spare parts

Workpiece
materials

Grade CP600

SMG		CW = 3 CW = 0.118		CW = 4 CW = 0.157		CW = 5 CW = 0.197		CW = 6 CW = 0.236	
		f	v _c	f	v _c	f	v _c	f	v _c
P1	-MC CP600	0,090	215	0,18	165	0,20	155	0,22	150
		0.0036	710	0.0070	540	0.0080	510	0.0085	490
P2	-MC CP600	0,090	210	0,18	160	0,22	145	0,24	140
		0.0036	690	0.0070	520	0.0085	475	0.0095	460
P3	-MC CP600	0,085	185	0,17	140	0,20	130	0,22	125
		0.0034	610	0.0065	460	0.0080	425	0.0085	410
P4	-MC CP600	0,085	160	0,17	125	0,20	115	0,22	110
		0.0034	520	0.0065	410	0.0080	375	0.0085	360
P5	-MC CP600	0,085	155	0,16	120	0,19	110	0,22	105
		0.0034	510	0.0065	395	0.0075	360	0.0085	345
P6	-MC CP600	0,085	175	0,16	135	0,19	125	0,22	120
		0.0034	570	0.0065	445	0.0075	410	0.0085	395
P7	-MC CP600	0,085	165	0,16	130	0,19	120	0,22	110
		0.0034	540	0.0065	425	0.0075	395	0.0085	360
P8	-MC CP600	0,085	155	0,17	120	0,20	110	0,22	105
		0.0034	510	0.0065	395	0.0080	360	0.0085	345
P11	-MC CP600	0,085	160	0,16	125	0,19	115	0,22	110
		0.0034	520	0.0065	410	0.0075	375	0.0085	360
P12	-MC CP600	0,055	105	0,11	85	0,13	80	0,14	75
		0.0022	345	0.0044	280	0.0050	260	0.0055	245
M1	-MC CP600	0,090	245	0,18	165	0,22	135	0,24	125
		0.0036	800	0.0070	540	0.0085	445	0.0095	410
M2	-MC CP600	0,085	200	0,16	145	0,19	125	0,22	110
		0.0034	660	0.0065	475	0.0075	410	0.0085	360
M3	-MC CP600	0,065	155	0,13	125	0,15	115	0,17	105
		0.0026	510	0.0050	410	0.0060	375	0.0065	345
M4	-MC CP600	0,060	115	0,11	100	0,14	90	0,15	85
		0.0024	375	0.0044	330	0.0055	295	0.0060	280
M5	-MC CP600	0,060	95	0,11	85	0,14	75	0,15	70
		0.0024	310	0.0044	280	0.0055	245	0.0060	230
K1	-MC CP600	0,090	195	0,18	145	0,22	135	0,24	130
		0.0036	640	0.0070	475	0.0085	445	0.0095	425
K2	-MC CP600	0,085	170	0,16	125	0,19	115	0,22	105
		0.0034	560	0.0065	410	0.0075	375	0.0085	345
K3	-MC CP600	0,085	145	0,16	105	0,19	95	0,22	90
		0.0034	475	0.0065	345	0.0075	310	0.0085	295
K4	-MC CP600	0,085	140	0,16	100	0,19	90	0,22	85
		0.0034	460	0.0065	330	0.0075	295	0.0085	280
K5	-MC CP600	0,075	85	0,15	60	0,17	55	0,19	55
		0.0030	280	0.0060	195	0.0065	180	0.0075	180
K6	-MC CP600	0,085	120	0,16	95	0,19	85	0,22	80
		0.0034	395	0.0065	310	0.0075	280	0.0085	260
K7	-MC CP600	0,075	110	0,15	80	0,17	75	0,19	70
		0.0030	360	0.0060	260	0.0065	245	0.0075	230
N11	-MC CP600	0,12	130	0,22	100	0,28	90	0,30	85
		0.0048	425	0.0085	330	0.011	295	0.012	280
S1	-MC CP600	0,060	26	0,11	21	0,14	20	0,15	19
		0.0024	85	0.0044	70	0.0055	65	0.0060	60
S2	-MC CP600	0,060	23	0,11	19	0,14	17	0,15	16
		0.0024	75	0.0044	60	0.0055	55	0.0060	50
S3	-MC CP600	0,055	20	0,11	16	0,13	15	0,14	15
		0.0022	65	0.0044	50	0.0050	49	0.0055	49

General ISO Turning

Steadyline®

MDT

Mini-Shaft™

Grooving

Parting-off

X4

Adapters
Clamping units

Accessories and
Spare parts

Workpiece
materials

Grade CP600

SMG		CW = 2 CW = 0.079	
		f	v _c
P1	-FT CP600	0,085	210
		0.0034	690
P2	-FT CP600	0,090	200
		0.0036	660
P3	-FT CP600	0,085	175
		0.0034	570
P4	-FT CP600	0,080	160
		0.0032	520
P5	-FT CP600	0,080	150
		0.0032	490
P6	-FT CP600	0,080	170
		0.0032	560
P7	-FT CP600	0,080	160
		0.0032	520
P8	-FT CP600	0,085	150
		0.0034	490
P11	-FT CP600	0,080	155
		0.0032	510
P12	-FT CP600	0,055	100
		0.0022	330
M1	-FT CP600	0,090	240
		0.0036	790
M2	-FT CP600	0,080	195
		0.0032	640
M3	-FT CP600	0,065	155
		0.0026	510
M4	-FT CP600	0,055	115
		0.0022	375
M5	-FT CP600	0,055	95
		0.0022	310
K1	-FT CP600	0,090	185
		0.0036	610
K2	-FT CP600	0,080	165
		0.0032	540
K3	-FT CP600	0,080	140
		0.0032	460
K4	-FT CP600	0,080	135
		0.0032	445
K5	-FT CP600	0,070	85
		0.0028	280
K6	-FT CP600	0,080	120
		0.0032	395
K7	-FT CP600	0,070	105
		0.0028	345
N11	-FT CP600	0,11	125
		0.0044	410
S1	-FT CP600	0,055	26
		0.0022	85
S2	-FT CP600	0,055	22
		0.0022	70
S3	-FT CP600	0,055	19
		0.0022	60

Grade TGH1050

SMG		CW = 3 CW = 0.118		CW = 4 CW = 0.157		CW = 5 CW = 0.197		CW = 6 CW = 0.236	
		f	v _c	f	v _c	f	v _c	f	v _c
H3	-MP TGH1050	0,070	48	0,080	47	0,085	47	0,085	47
		0.0028	155	0.0032	155	0.0034	155	0.0034	155
H5	-MP TGH1050	0,11	85	0,12	85	0,13	80	0,13	80
		0.0044	280	0.0048	280	0.0050	260	0.0050	260
H7	-MP TGH1050	0,070	48	0,080	47	0,085	47	0,085	47
		0.0028	155	0.0032	155	0.0034	155	0.0034	155
H8	-MP TGH1050	0,080	90	0,090	85	0,095	85	0,10	85
		0.0032	295	0.0036	280	0.0038	280	0.0040	280
H11	-MP TGH1050	0,11	110	0,12	105	0,13	105	0,13	105
		0.0044	360	0.0048	345	0.0050	345	0.0050	345
H12	-MP TGH1050	0,080	100	0,090	100	0,095	100	0,10	100
		0.0032	330	0.0036	330	0.0038	330	0.0040	330
H21	-MP TGH1050	0,080	90	0,090	85	0,095	85	0,10	85
		0.0032	295	0.0036	280	0.0038	280	0.0040	280
H31	-MP TGH1050	0,070	65	0,080	65	0,085	65	0,085	65
		0.0028	215	0.0032	215	0.0034	215	0.0034	215

Grade TGK1500

SMG		CW = 2 CW = 0.079		CW = 3 CW = 0.118		CW = 4 CW = 0.157		CW = 5 CW = 0.197		CW = 6-8 CW = 0.236-0.315	
		f	V _c	f	V _c	f	V _c	f	V _c	f	V _c
K1	-MT, -FT	0,10	295	0,18	230	0,22	205	0,26	185	0,30	165
	TGK1500	0.0040	970	0.0070	750	0.0085	670	0.010	610	0.012	540
K2	-MT, -FT	0,095	180	0,16	155	0,20	145	0,24	135	0,28	125
	TGK1500	0.0038	590	0.0065	510	0.0080	475	0.0095	445	0.011	410
K3	-MT, -FT	0,095	150	0,16	130	0,20	120	0,24	110	0,28	105
	TGK1500	0.0038	490	0.0065	425	0.0080	395	0.0095	360	0.011	345
K4	-MT, -FT	0,095	145	0,16	125	0,20	115	0,24	105	0,28	100
	TGK1500	0.0038	475	0.0065	410	0.0080	375	0.0095	345	0.011	330
K5	-MT, -FT	0,085	90	0,15	75	0,19	70	0,22	65	0,25	60
	TGK1500	0.0034	295	0.0060	245	0.0075	230	0.0085	215	0.010	195
K6	-MT, -FT	0,095	180	0,16	150	0,20	130	0,24	120	0,28	105
	TGK1500	0.0038	590	0.0065	490	0.0080	425	0.0095	395	0.011	345
K7	-MT, -FT	0,085	110	0,15	95	0,19	90	0,22	85	0,25	80
	TGK1500	0.0034	360	0.0060	310	0.0075	295	0.0085	280	0.010	260

Grade 883

SMG		CW = 3 CW = 0.118		CW = 4 CW = 0.157		CW = 5 CW = 0.197		CW = 6 CW = 0.236		CW = 8-10 CW = 0.315-0.394	
		f	V _c	f	V _c	f	V _c	f	V _c	f	V _c
K1	-MT 883, 890	0,19	95	0,22	90	0,26	80	0,28	80	0,38	65
		0.0075	310	0.0085	295	0.010	260	0.011	260	0.015	215
K2	-MT 883, 890	0,17	85	0,20	80	0,24	75	0,25	70	0,34	60
		0.0065	280	0.0080	260	0.0095	245	0.010	230	0.013	195
K3	-MT 883, 890	0,17	70	0,20	65	0,24	60	0,25	60	0,34	50
		0.0065	230	0.0080	215	0.0095	195	0.010	195	0.013	165
K4	-MT 883, 890	0,17	70	0,20	65	0,24	60	0,25	55	0,34	49
		0.0065	230	0.0080	215	0.0095	195	0.010	180	0.013	160
K5	-MT 883, 890	0,15	43	0,18	40	0,20	37	0,22	36	0,30	31
		0.0060	140	0.0070	130	0.0080	120	0.0085	120	0.012	100
K6	-MT 883, 890	0,17	60	0,20	55	0,24	50	0,25	50	0,34	43
		0.0065	195	0.0080	180	0.0095	165	0.010	165	0.013	140
K7	-MT 883, 890	0,15	55	0,18	50	0,20	48	0,22	46	0,30	40
		0.0060	180	0.0070	165	0.0080	155	0.0085	150	0.012	130
N1	-MT 883, 890	0,24	275	0,28	255	0,32	235	0,36	220	0,48	190
		0.0095	900	0.011	840	0.013	770	0.014	720	0.019	620
N2	-MT 883, 890	0,24	220	0,28	205	0,32	190	0,36	180	0,48	155
		0.0095	720	0.011	670	0.013	620	0.014	590	0.019	510
N3	-MT 883, 890	0,24	145	0,28	135	0,32	125	0,36	120	0,48	100
		0.0095	475	0.011	445	0.013	410	0.014	395	0.019	330
N11	-MT 883, 890	0,24	170	0,28	155	0,32	145	0,36	135	0,48	115
		0.0095	560	0.011	510	0.013	475	0.014	445	0.019	375
S1	-MT 883, 890	0,12	19	0,14	18	0,16	17	0,18	16	0,24	14
		0.0048	60	0.0055	60	0.0065	55	0.0070	50	0.0095	46
S2	-MT 883, 890	0,12	15	0,14	14	0,16	14	0,18	13	0,24	11
		0.0048	49	0.0055	46	0.0065	46	0.0070	43	0.0095	36
S3	-MT 883, 890	0,11	14	0,13	13	0,15	12	0,17	11	0,22	10
		0.0044	46	0.0050	43	0.0060	39	0.0065	36	0.0085	33
S11	-MT 883, 890	0,13	27	0,16	25	0,19	23	0,20	22	0,28	19
		0.0050	90	0.0065	80	0.0075	75	0.0080	70	0.011	60
S12	-MT 883, 890	0,13	21	0,16	19	0,19	18	0,20	17	0,28	15
		0.0050	70	0.0065	60	0.0075	60	0.0080	55	0.011	49
S13	-MT 883, 890	0,12	16	0,14	15	0,16	15	0,18	14	0,24	12
		0.0048	50	0.0055	49	0.0065	49	0.0070	46	0.0095	39
H5	-MT 883, 890	0,11	33	0,13	31	0,16	28	0,17	28	0,24	24
		0.0044	110	0.0050	100	0.0065	90	0.0065	90	0.0095	80

General ISO Turning

Steadyline®

MDT

Mini-Shaft™

Grooving

Parting-off

X4

Adapters
Clamping units

Accessories and
Spare parts

Workpiece
materials

Grade CP200

SMG		CW = 3 CW = 0.118		CW = 4 CW = 0.157		CW = 5 CW = 0.197		CW = 6 CW = 0.236		CW = 8 CW = 0.315	
		f	v _c	f	v _c	f	v _c	f	v _c	f	v _c
M1	-FT CP200	0,16	210	0,19	180	0,24	145	0,26	130	0,36	85
		0.0065	690	0.0075	590	0.0095	475	0.010	425	0.014	280
M2	-FT CP200	0,14	185	0,18	155	0,22	125	0,24	115	0,32	80
		0.0055	610	0.0070	510	0.0085	410	0.0095	375	0.013	260
M3	-FT CP200	0,12	150	0,14	135	0,17	120	0,19	110	0,26	75
		0.0048	490	0.0055	445	0.0065	395	0.0075	360	0.010	245
M4	-FT CP200	0,10	120	0,12	110	0,15	95	0,17	90	0,22	70
		0.0040	395	0.0048	360	0.0060	310	0.0065	295	0.0085	230
M5	-FT CP200	0,10	100	0,12	95	0,15	80	0,17	75	0,22	55
		0.0040	330	0.0048	310	0.0060	260	0.0065	245	0.0085	180
S1	-FT CP200	0,10	28	0,12	26	0,15	24	0,17	23	0,22	20
		0.0040	90	0.0048	85	0.0060	80	0.0065	75	0.0085	65
S2	-FT CP200	0,10	22	0,12	21	0,15	19	0,17	18	0,22	16
		0.0040	70	0.0048	70	0.0060	60	0.0065	60	0.0085	50
S3	-FT CP200	0,095	19	0,11	18	0,14	17	0,15	16	0,20	15
		0.0038	60	0.0044	60	0.0055	55	0.0060	50	0.0080	49
S11	-FT CP200	0,12	38	0,14	35	0,17	33	0,19	31	0,26	27
		0.0048	125	0.0055	115	0.0065	110	0.0075	100	0.010	90
S12	-FT CP200	0,12	29	0,14	27	0,17	25	0,19	24	0,26	21
		0.0048	95	0.0055	90	0.0065	80	0.0075	80	0.010	70
S13	-FT CP200	0,10	24	0,12	22	0,15	20	0,17	19	0,22	17
		0.0040	80	0.0048	70	0.0060	65	0.0065	60	0.0085	55

General ISO Turning

Steadyline®

MDT

Mini-Shaft™

Grooving

Parting-off

X4

Adapters
Clamping units

Accessories and
Spare parts

Workpiece
materials

C.-CFIR/L...JET – Toolholders for inserts LCGF, LCGN, LCMF and LCMR – Metric / Inch

C.-CFIR/L
KAPR = 90,0°

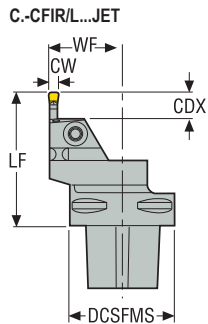
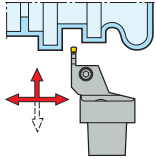

- For inserts program, see page(s) 839-852, 854-855
- * DCINN3 – minimum bore diameter for internal application, see page(s) 705
- For more information on Jetstream Tooling® (High pressure coolant) and accessories, please see page(s) 38, 85-89, 1002
- CTMS = Seco-Capto™ size
- CTWS = Insert shape and size
- ** Max depth of cut for double-sided LCGF/LCMF16.. = 14 mm / 0.551 inch, LCGF/LCMF30.. = 28 mm / 1.102 inch
- *** Max coolant pressure
- CDX = 3 x CW
- Right-hand version shown
- Please check availability at www.secotools.com / Seco Online Store

Designation	Item number	CTMS	DCSFMS	WF	LF	CDX**	DCINN3*	CP***	Weight	CW	TQ	CTWS
			mm Inch	mm Inch	mm Inch	mm Inch	mm Inch	bar psi	kg lbs	mm Inch	Nm In/Lbs.	
C4-CFIR-27060-03JET	02612574	C4	40,0 1.575	27,0 1.063	60 2.362	9,0 0.354	195,0 7.677	70,0 1015.3	0,5 1.100	3,0 0.118	6,0 53.1	LC..1603..
C4-CFIL-27060-03JET	02612558	C4	40,0 1.575	27,0 1.063	60 2.362	9,0 0.354	195,0 7.677	70,0 1015.3	0,5 1.100	3,0 0.118	6,0 53.1	LC..1603..
C4-CFIR-27060-04JET	02612578	C4	40,0 1.575	27,0 1.063	60 2.362	12,0 0.472	195,0 7.677	70,0 1015.3	0,5 1.100	4,0 0.157	8,0 70.8	LC..1604..
C4-CFIL-27060-04JET	02612571	C4	40,0 1.575	27,0 1.063	60 2.362	12,0 0.472	195,0 7.677	70,0 1015.3	0,5 1.100	4,0 0.157	8,0 70.8	LC..1604..
C4-CFIR-27065-05JET	02612579	C4	40,0 1.575	27,0 1.063	65 2.559	16,5 0.650	195,0 7.677	70,0 1015.3	0,5 1.100	5,0 0.197	8,0 70.8	LC..1605..
C4-CFIL-27065-05JET	02612573	C4	40,0 1.575	27,0 1.063	65 2.559	16,5 0.650	195,0 7.677	70,0 1015.3	0,5 1.100	5,0 0.197	8,0 70.8	LC..1605..
C5-CFIR-35060-03JET	02612585	C5	50,0 1.969	35,0 1.378	60 2.362	9,0 0.354	195,0 7.677	70,0 1015.3	0,7 1.540	3,0 0.118	6,0 53.1	LC..1603..
C5-CFIL-35060-03JET	02612580	C5	50,0 1.969	35,0 1.378	60 2.362	9,0 0.354	195,0 7.677	70,0 1015.3	0,7 1.540	3,0 0.118	6,0 53.1	LC..1603..
C5-CFIR-35065-04JET	02612588	C5	50,0 1.969	35,0 1.378	65 2.559	12,0 0.472	195,0 7.677	70,0 1015.3	0,7 1.540	4,0 0.157	8,0 70.8	LC..1604..
C5-CFIL-35065-04JET	02612581	C5	50,0 1.969	35,0 1.378	65 2.559	12,0 0.472	195,0 7.677	70,0 1015.3	0,7 1.540	4,0 0.157	8,0 70.8	LC..1604..
C5-CFIR-35065-05JET	02612589	C5	50,0 1.969	35,0 1.378	65 2.559	15,0 0.591	195,0 7.677	70,0 1015.3	0,7 1.540	5,0 0.197	8,0 70.8	LC..1605..
C5-CFIL-35065-05JET	02612582	C5	50,0 1.969	35,0 1.378	65 2.559	15,0 0.591	195,0 7.677	70,0 1015.3	0,7 1.540	5,0 0.197	8,0 70.8	LC..1605..
C5-CFIR-35075-06JET	02612590	C5	50,0 1.969	35,0 1.378	75 2.953	18,0 0.709	195,0 7.677	70,0 1015.3	0,8 1.760	6,0 0.236	10,0 88.5	LC..1606..
C5-CFIL-35075-06JET	02612584	C5	50,0 1.969	35,0 1.378	75 2.953	18,0 0.709	195,0 7.677	70,0 1015.3	0,8 1.760	6,0 0.236	10,0 88.5	LC..1606..
C6-CFIR-45065-03JET	02612602	C6	63,0 2.480	45,0 1.772	65 2.559	9,0 0.354	195,0 7.677	70,0 1015.3	1,1 2.430	3,0 0.118	6,0 53.1	LC..1603..
C6-CFIL-45065-03JET	02612596	C6	63,0 2.480	45,0 1.772	65 2.559	9,0 0.354	195,0 7.677	70,0 1015.3	1,1 2.430	3,0 0.118	6,0 53.1	LC..1603..
C6-CFIR-45065-04JET	02612603	C6	63,0 2.480	45,0 1.772	65 2.559	12,0 0.472	195,0 7.677	70,0 1015.3	1,1 2.430	4,0 0.157	8,0 70.8	LC..1604..

General / ISO Turning

Steadyline®

MDT

Mini-Shaft™

Grooving

Parting-off

X4

Adapters
Clamping units

Accessories and
Spare parts

Workpiece
materials

General ISO Turning	Designation	Item number	CTMS	DCSFMS	WF	LF	CDX**	DCINN3*	CP***	Weight	CW	TQ	CTWS
				mm Inch	mm Inch	mm Inch	mm Inch	mm Inch	bar psi	kg lbs	mm Inch	Nm In/Lbs.	
	C6-CFIL-45065-04JET	02612598	C6	63,0 2.480	45,0 1.772	65 2.559	12,0 0.472	195,0 7.677	70,0 1015.3	1,1 2.430	4,0 0.157	8,0 70.8	LC..1604..
	C6-CFIR-45070-05JET	02612604	C6	63,0 2.480	45,0 1.772	70 2.756	15,0 0.591	195,0 7.677	70,0 1015.3	1,1 2.430	5,0 0.197	8,0 70.8	LC..1605..
	C6-CFIL-45070-05JET	02612599	C6	63,0 2.480	45,0 1.772	70 2.756	15,0 0.591	195,0 7.677	70,0 1015.3	1,1 2.430	5,0 0.197	8,0 70.8	LC..1605..
Steadyline®	C6-CFIR-45075-06JET	02612606	C6	63,0 2.480	45,0 1.772	75 2.953	18,0 0.709	195,0 7.677	70,0 1015.3	1,2 2.650	6,0 0.236	10,0 88.5	LC..1606..
	C6-CFIL-45075-06JET	02612600	C6	63,0 2.480	45,0 1.772	75 2.953	18,0 0.709	195,0 7.677	70,0 1015.3	1,2 2.650	6,0 0.236	10,0 88.5	LC..1606..
	C6-CFIR-45085-08JET	02612607	C6	63,0 2.480	45,0 1.772	85 3.346	24,0 0.945	195,0 7.677	70,0 1015.3	1,3 2.870	8,0 0.315	15,0 132.8	LC..3008..
MDT	C6-CFIL-45085-08JET	02612601	C6	63,0 2.480	45,0 1.772	85 3.346	24,0 0.945	195,0 7.677	70,0 1015.3	1,3 2.870	8,0 0.315	15,0 132.8	LC..3008..

Spare Parts

For size	Clamp key	Clamp screw
CFIR/L...03	4SMS795	TCEI0513
CFIR/L...04	5SMS795	TCEI0613
CFIR/L...05	5SMS795	TCEI0613
CFIR/L...06	6SMS795	TCEI0815
CFIR/L...08	6SMS795	TCEI1020

- Mini-Shaft™
- Grooving
- Parting-off
- X4
- Adapters Clamping units
- Accessories and Spare parts
- Workpiece materials

C.-CFMR/L...JET – Toolholders for inserts LCGF, LCGN, LCMF and LCMR – Metric / Inch

C.-CFMR/L
KAPR = 90,0°

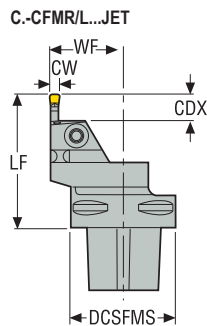
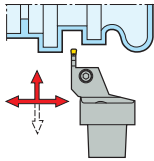

- For inserts program, see page(s) 839-852, 854-855
- * DCINN3 – minimum bore diameter for internal application, see page(s) 705
- For more information on Jetstream Tooling® (High pressure coolant) and accessories, please see page(s) 38, 85-89, 1002
- CTMS = Seco-Capto™ size
- CTWS = Insert shape and size
- ** Max depth of cut for double-sided LCGF/LCMF16.. = 14 mm / 0.551 inch, LCGF/LCMF30.. = 28 mm / 1.102 inch
- *** Max coolant pressure
- CDX = 5 x CW
- Right-hand version shown
- Please check availability at www.secotools.com / Seco Online Store

Designation	Item number	CTMS	DCSFMS	WF	LF	CDX**	DCINN3*	CP***	Weight	CW	TQ	CTWS
			mm Inch	mm Inch	mm Inch	mm Inch	mm Inch	bar psi	kg lbs	mm Inch	Nm In/Lbs.	
C4-CFMR-27070-03JET	02702850	C4	40,0 1.575	27,0 1.063	70 2.756	16,5 0.650	195,0 7.677	70,0 1015.3	0,5 1.100	3,0 0.118	6,0 53.1	LC..1603..
C4-CFML-27070-03JET	02702870	C4	40,0 1.575	27,0 1.063	70 2.756	16,5 0.650	195,0 7.677	70,0 1015.3	0,5 1.100	3,0 0.118	6,0 53.1	LC..1603..
C4-CFMR-27070-04JET	02702858	C4	40,0 1.575	27,0 1.063	70 2.756	20,0 0.787	195,0 7.677	70,0 1015.3	0,5 1.100	4,0 0.157	8,0 70.8	LC..1604..
C4-CFML-27070-04JET	02702873	C4	40,0 1.575	27,0 1.063	70 2.756	20,0 0.787	195,0 7.677	70,0 1015.3	0,5 1.100	4,0 0.157	8,0 70.8	LC..1604..
C5-CFMR-35070-03JET	02702859	C5	50,0 1.969	35,0 1.378	70 2.756	15,0 0.591	195,0 7.677	70,0 1015.3	0,7 1.540	3,0 0.118	6,0 53.1	LC..1603..
C5-CFML-35070-03JET	02702874	C5	50,0 1.969	35,0 1.378	70 2.756	15,0 0.591	195,0 7.677	70,0 1015.3	0,7 1.540	3,0 0.118	6,0 53.1	LC..1603..
C5-CFMR-35075-04JET	02702860	C5	50,0 1.969	35,0 1.378	75 2.953	20,0 0.787	195,0 7.677	70,0 1015.3	0,7 1.540	4,0 0.157	8,0 70.8	LC..1604..
C5-CFML-35075-04JET	02702876	C5	50,0 1.969	35,0 1.378	75 2.953	20,0 0.787	195,0 7.677	70,0 1015.3	0,7 1.540	4,0 0.157	8,0 70.8	LC..1604..
C5-CFMR-35075-05JET	02702861	C5	50,0 1.969	35,0 1.378	75 2.953	25,0 0.984	195,0 7.677	70,0 1015.3	0,7 1.540	5,0 0.197	8,0 70.8	LC..1605..
C5-CFML-35075-05JET	02702877	C5	50,0 1.969	35,0 1.378	75 2.953	25,0 0.984	195,0 7.677	70,0 1015.3	0,7 1.540	5,0 0.197	8,0 70.8	LC..1605..
C5-CFMR-35085-06JET	02702862	C5	50,0 1.969	35,0 1.378	85 3.346	30,0 1.181	195,0 7.677	70,0 1015.3	0,8 1.760	6,0 0.236	10,0 88.5	LC..1606..
C5-CFML-35085-06JET	02702891	C5	50,0 1.969	35,0 1.378	85 3.346	30,0 1.181	195,0 7.677	70,0 1015.3	0,8 1.760	6,0 0.236	10,0 88.5	LC..1606..
C6-CFMR-45080-03JET	02702863	C6	63,0 2.480	45,0 1.772	80 3.150	15,0 0.591	195,0 7.677	70,0 1015.3	1,2 2.650	3,0 0.118	6,0 53.1	LC..1603..
C6-CFML-45080-03JET	02702881	C6	63,0 2.480	45,0 1.772	80 3.150	15,0 0.591	195,0 7.677	70,0 1015.3	2,0 4.410	3,0 0.118	6,0 53.1	LC..1603..
C6-CFMR-45080-04JET	02702864	C6	63,0 2.480	45,0 1.772	80 3.150	20,0 0.787	195,0 7.677	70,0 1015.3	1,2 2.650	4,0 0.157	8,0 70.8	LC..1604..
C6-CFML-45080-04JET	02702882	C6	63,0 2.480	45,0 1.772	80 3.150	20,0 0.787	195,0 7.677	70,0 1015.3	1,2 2.650	4,0 0.157	8,0 70.8	LC..1604..
C6-CFMR-45080-05JET	02702865	C6	63,0 2.480	45,0 1.772	80 3.150	25,0 0.984	195,0 7.677	70,0 1015.3	1,1 2.430	5,0 0.197	8,0 70.8	LC..1605..

General ISO Turning

Steadyline®

MDT

Mini-Shaft™

Grooving

Parting-off



X4

Adapters
Clamping units

Accessories and
Spare parts

Workpiece
materials

General ISO Turning	Designation	Item number	CTMS	DCSFMS	WF	LF	CDX**	DCINN3*	CP***	Weight	CW	TQ	CTWS
				mm Inch	mm Inch	mm Inch	mm Inch	mm Inch	bar psi	kg lbs	mm Inch	Nm In/Lbs.	
	C6-CFML-45080-05JET	02702884	C6	63,0 2.480	45,0 1.772	80 3.150	25,0 0.984	195,0 7.677	70,0 1015.3	1,1 2.430	5,0 0.197	8,0 70.8	LC..1605..
C6-CFMR-45085-06JET	02702867	C6	63,0 2.480	45,0 1.772	85 3.346	30,0 1.181	195,0 7.677	70,0 1015.3	1,2 2.650	6,0 0.236	10,0 88.5	LC..1606..	
C6-CFML-45085-06JET	02702885	C6	63,0 2.480	45,0 1.772	85 3.346	30,0 1.181	195,0 7.677	70,0 1015.3	1,2 2.650	6,0 0.236	10,0 88.5	LC..1606..	

Steadyline®	Spare Parts		
	For size	Clamp key	Clamp screw
			
MDT	CFMR/L..-03	4SMS795	TCEI0513
	CFMR/L..-04	5SMS795	TCEI0613
	CFMR/L..-05	5SMS795	TCEI0613
	CFMR/L..-06	6SMS795	TCEI0815

Mini-Shaft™	
Grooving	
Parting-off	
X4	
Adapters Clamping units	
Accessories and Spare parts	
Workpiece materials	

C.-CFOR/L...JET – Toolholders for inserts LCGF, LCGN, LCMF and LCMR – Metric / Inch

C.-CFOR/L
KAPR = 90,0°

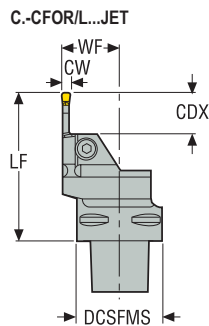
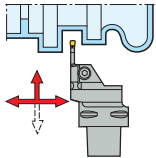

- For inserts program, see page(s) 839-852, 854-855
- * DCINN3 – minimum bore diameter for internal application, see page(s) 705
- For more information on Jetstream Tooling® (High pressure coolant) and accessories, please see page(s) 38, 85-89, 1002
- CTMS = Seco-Capto™ size
- CTWS = Insert shape and size
- ** Max depth of cut for double-sided LCGF/LCMF16.. = 14 mm / 0.551 inch, LCGF/LCMF30.. = 28 mm / 1.102 inch
- *** Max coolant pressure
- CDX = 6 x CW
- Right-hand version shown
- Please check availability at www.secotools.com / Seco Online Store

Designation	Item number	CTMS	DCSFMS	WF	LF	CDX**	DCINN3*	CP***	Weight	CW	TQ	CTWS
			mm Inch	mm Inch	mm Inch	mm Inch	mm Inch	bar psi	kg lbs	mm Inch	Nm In/Lbs.	
C4-CFOR-27070-03-JET	02718439	C4	40,0 1.575	27,0 1.063	70 2.756	19,5 0.768	195,0 7.677	70,0 1015.3	0,5 1.100	3,0 0.118	6,0 53.1	LC..1603..
C4-CFOL-27070-03-JET	02717403	C4	40,0 1.575	27,0 1.063	70 2.756	19,5 0.768	195,0 7.677	70,0 1015.3	0,5 1.100	3,0 0.118	6,0 53.1	LC..1603..
C4-CFOR-27080-04-JET	02718440	C4	40,0 1.575	27,0 1.063	80 3.150	24,0 0.945	195,0 7.677	70,0 1015.3	0,5 1.100	4,0 0.157	8,0 70.8	LC..1604..
C4-CFOL-27080-04-JET	02718437	C4	40,0 1.575	27,0 1.063	80 3.150	24,0 0.945	195,0 7.677	70,0 1015.3	0,5 1.100	4,0 0.157	8,0 70.8	LC..1604..
C4-CFOR-27085-05-JET	02718441	C4	40,0 1.575	27,0 1.063	85 3.346	30,0 1.181	195,0 7.677	70,0 1015.3	0,5 1.100	5,0 0.197	8,0 70.8	LC..1605..
C4-CFOL-27085-05-JET	02718438	C4	40,0 1.575	27,0 1.063	85 3.346	30,0 1.181	195,0 7.677	70,0 1015.3	0,5 1.100	5,0 0.197	8,0 70.8	LC..1605..
C5-CFOR-35070-03-JET	02718446	C5	50,0 1.969	35,0 1.378	70 2.756	18,0 0.709	195,0 7.677	70,0 1015.3	0,7 1.540	3,0 0.118	6,0 53.1	LC..1603..
C5-CFOL-35070-03-JET	02718442	C5	50,0 1.969	35,0 1.378	70 2.756	18,0 0.709	195,0 7.677	70,0 1015.3	0,7 1.540	3,0 0.118	6,0 53.1	LC..1603..
C5-CFOR-35080-04-JET	02718447	C5	50,0 1.969	35,0 1.378	80 3.150	24,0 0.945	195,0 7.677	70,0 1015.3	0,8 1.760	4,0 0.157	8,0 70.8	LC..1604..
C5-CFOL-35080-04-JET	02718443	C5	50,0 1.969	35,0 1.378	80 3.150	24,0 0.945	195,0 7.677	70,0 1015.3	0,8 1.760	4,0 0.157	8,0 70.8	LC..1604..
C5-CFOR-35085-05-JET	02718448	C5	50,0 1.969	35,0 1.378	85 3.346	30,0 1.181	195,0 7.677	70,0 1015.3	0,8 1.760	5,0 0.197	8,0 70.8	LC..1605..
C5-CFOL-35085-05-JET	02718444	C5	50,0 1.969	35,0 1.378	85 3.346	30,0 1.181	195,0 7.677	70,0 1015.3	0,8 1.760	5,0 0.197	8,0 70.8	LC..1605..
C5-CFOR-35100-06-JET	02718449	C5	50,0 1.969	35,0 1.378	100 3.937	36,0 1.417	195,0 7.677	70,0 1015.3	1,0 2.200	6,0 0.236	10,0 88.5	LC..1606..
C5-CFOL-35100-06-JET	02718445	C5	50,0 1.969	35,0 1.378	100 3.937	36,0 1.417	195,0 7.677	70,0 1015.3	1,0 2.200	6,0 0.236	10,0 88.5	LC..1606..
C6-CFOR-45075-03-JET	02718455	C6	63,0 2.480	45,0 1.772	75 2.953	18,0 0.709	195,0 7.677	70,0 1015.3	1,2 2.650	3,0 0.118	6,0 53.1	LC..1603..
C6-CFOL-45075-03-JET	02718450	C6	63,0 2.480	45,0 1.772	75 2.953	18,0 0.709	195,0 7.677	70,0 1015.3	1,2 2.650	3,0 0.118	6,0 53.1	LC..1603..
C6-CFOR-45080-04-JET	02718456	C6	63,0 2.480	45,0 1.772	80 3.150	24,0 0.945	195,0 7.677	70,0 1015.3	1,1 2.430	4,0 0.157	8,0 70.8	LC..1604..

General / ISO Turning

Steadyline®

MDT

Mini-Shaft™

Grooving

Parting-off

X4

Adapters
Clamping units

Accessories and
Spare parts

Workpiece
materials

General ISO Turning	Designation	Item number	CTMS	DCSFMS	WF	LF	CDX**	DCINN3*	CP***	Weight	CW	TQ	CTWS
				mm Inch	mm Inch	mm Inch	mm Inch	mm Inch	bar psi	kg lbs	mm Inch	Nm In/Lbs.	
	C6-CFOL-45080-04-JET	02718451	C6	63,0 2.480	45,0 1.772	80 3.150	24,0 0.945	195,0 7.677	70,0 1015.3	1,1 2.430	4,0 0.157	8,0 70.8	LC..1604..
	C6-CFOR-45090-05-JET	02718457	C6	63,0 2.480	45,0 1.772	90 3.543	30,0 1.181	195,0 7.677	70,0 1015.3	1,2 2.650	5,0 0.197	8,0 70.8	LC..1605..
	C6-CFOL-45090-05-JET	02718452	C6	63,0 2.480	45,0 1.772	90 3.543	30,0 1.181	195,0 7.677	70,0 1015.3	1,2 2.650	5,0 0.197	8,0 70.8	LC..1605..
Steadyline®	C6-CFOR-45100-06-JET	02718458	C6	63,0 2.480	45,0 1.772	100 3.937	36,0 1.417	195,0 7.677	70,0 1015.3	1,3 2.870	6,0 0.236	10,0 88.5	LC..1606..
	C6-CFOL-45100-06-JET	02718453	C6	63,0 2.480	45,0 1.772	100 3.937	36,0 1.417	195,0 7.677	70,0 1015.3	1,3 2.870	6,0 0.236	10,0 88.5	LC..1606..
	C6-CFOR-45115-08-JET	02718459	C6	63,0 2.480	45,0 1.772	115 4.528	48,0 1.890	195,0 7.677	70,0 1015.3	1,4 3.090	8,0 0.315	15,0 132.8	LC..3008..
MDT	C6-CFOL-45115-08-JET	02718454	C6	63,0 2.480	45,0 1.772	115 4.528	48,0 1.890	195,0 7.677	70,0 1015.3	1,4 3.090	8,0 0.315	15,0 132.8	LC..3008..

Spare Parts

For size	Clamp key	Clamp screw
		
CFOR/L..-03	4SMS795	TCEI0513
CFOR/L..-04	5SMS795	TCEI0613
CFOR/L..-05	5SMS795	TCEI0613
CFOR/L..-06	6SMS795	TCEI0815
CFOR/L..-08	6SMS795	TCEI1020

Mini-Shaft™

Grooving

Parting-off

X4

Adapters
Clamping units

Accessories and
Spare parts

Workpiece
materials

C.-CZFR/L...JET – Toolholders for inserts LCMF – Metric / Inch

C.-CFZR/L
KAPR = 90,0°

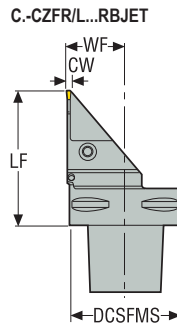
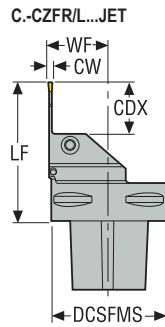
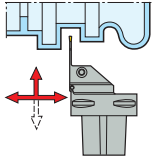

- For inserts program, see page(s) 838
- For more information on Jetstream Tooling® (High pressure coolant) and accessories, please see page(s) 38, 85-89, 1002
- * Due to the design, grooving depth is limited, see page(s) 705
- **** Max coolant pressure
- CTMS = Seco-Capto™ size
- CTWS = Insert shape and size
- RB = Reinforced blade
- CDX = 12,5 x CW
- Right-hand version shown
- Please check availability at www.secotools.com / Seco Online Store

Designation	Item number	CTMS	DCSFMS	WF	LF	CDX	CUTDIA*	CP***	Weight	CW	TQ	CTWS
			mm Inch	mm Inch	mm Inch	mm Inch	mm Inch	bar psi	kg lbs	mm Inch	Nm In/Lbs.	
C4-CFZR-22075-2802JET	02749022	C4	40,0 1.575	22,0 0.866	75,0 2.953	26,0 1.024	-	70,0 1015.3	0,5 1.100	2,0 0.079	6,0 53.1	LC..2802..
C4-CFZL-22075-2802JET	02749028	C4	40,0 1.575	22,0 0.866	75,0 2.953	26,0 1.024	-	70,0 1015.3	0,5 1.100	2,0 0.079	6,0 53.1	LC..2802..
C5-CFZR-27075-2802JET	02749023	C5	50,0 1.969	27,0 1.063	75,0 2.953	26,0 1.024	-	70,0 1015.3	0,7 1.540	2,0 0.079	6,0 53.1	LC..2802..
C5-CFZL-27075-2802JET	02749029	C5	50,0 1.969	27,0 1.063	75,0 2.953	26,0 1.024	-	70,0 1015.3	0,7 1.540	2,0 0.079	6,0 53.1	LC..2802..
C6-CFZR-33075-2802JET	02749024	C6	63,0 2.480	33,0 1.299	75,0 2.953	26,0 1.024	-	70,0 1015.3	1,0 2.200	2,0 0.079	6,0 53.1	LC..2802..
C6-CFZL-33075-2802JET	02749030	C6	63,0 2.480	33,0 1.299	75,0 2.953	26,0 1.024	-	70,0 1015.3	1,0 2.200	2,0 0.079	6,0 53.1	LC..2802..
C4-CFZR-22075-2802RBJET	02749025	C4	40,0 1.575	22,0 0.866	75,0 2.953	28,0 1.102	52,0 2.047	70,0 1015.3	0,6 1.320	2,0 0.079	6,0 53.1	LC..2802..
C4-CFZL-22075-2802RBJET	02749031	C4	40,0 1.575	22,0 0.866	75,0 2.953	28,0 1.102	52,0 2.047	70,0 1015.3	0,6 1.320	2,0 0.079	6,0 53.1	LC..2802..
C5-CFZR-27075-2802RBJET	02749026	C5	50,0 1.969	27,0 1.063	75,0 2.953	28,0 1.102	52,0 2.047	70,0 1015.3	0,7 1.540	2,0 0.079	6,0 53.1	LC..2802..
C5-CFZL-27075-2802RBJET	02749032	C5	50,0 1.969	27,0 1.063	75,0 2.953	28,0 1.102	52,0 2.047	70,0 1015.3	0,7 1.540	2,0 0.079	6,0 53.1	LC..2802..
C6-CFZR-33075-2802RBJET	02749027	C6	63,0 2.480	33,0 1.299	75,0 2.953	28,0 1.102	52,0 2.047	70,0 1015.3	1,1 2.430	2,0 0.079	6,0 53.1	LC..2802..
C6-CFZL-33075-2802RBJET	02749033	C6	63,0 2.480	33,0 1.299	75,0 2.953	28,0 1.102	52,0 2.047	70,0 1015.3	1,1 2.430	2,0 0.079	6,0 53.1	LC..2802..

Spare Parts

For size	Clamp key	Clamp screw
CFZR/L...02	4SMS795	TCEI0513



C-CF.N-RBJET – Toolholders for inserts LCGF, LCGN, LCMF and LCMR – Metric/ Inch

General ISO Turning

Steadyline®

MDT

Mini-Shaft™

Grooving

Parting-off

X4

Adapters
Clamping units

Accessories and
Spare parts

Workpiece
materials

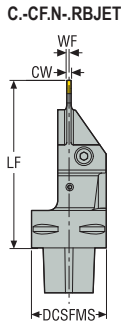

C-CF.N-RBJET
KAPR = 90,0 °

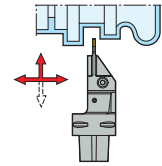

CTWS



- For inserts program, see page(s) 838-852, 854-855
- For more information on Jetstream Tooling® (High pressure coolant) and accessories, please see page(s) 38, 85-89, 1002
- * Due to the design, grooving depth is limited, see page(s) 705
- *** Max coolant pressure
- CTMS = Seco-Capto™ size
- CTWS = Insert shape and size
- RB = Reinforced blade
- Neutral version shown
- Please check availability at www.secotools.com / Seco Online Store

Designation	Item number	CTMS	DCSFMS	WF	LF	CUTDIA*	CP***	Weight	CW	TQ	CTWS
C4-CFZN-00075-2802RBJET	02975227	C4	40,0 1.575	1,0 0.039	75,0 2.953	52,0 2.047	70,0 1015.3	0,5 1.100	2,0 0.079	6,0 53.1	LC..2802..
C4-CFXN-00090-03RBJET	02975224	C4	40,0 1.575	1,5 0.059	90,0 3.543	64,0 2.520	70,0 1015.3	0,6 1.320	3,0 0.118	6,0 53.1	LC..1603..

Spare Parts

For size	Clamp key	Clamp screw
CFZN/CFXN	4SMS795	TCEI0513

C.-CFIR...L...JET, C.-CFIL...R...JET – Toolholders for inserts LCGF, LCGN, LCMF and LCMR – Metric / Inch

C.-CFIR/L
KAPR = 90,0 °

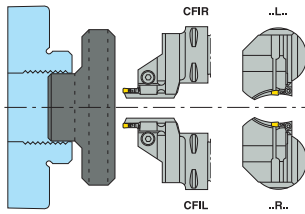
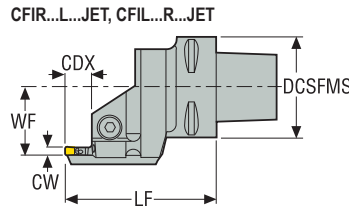
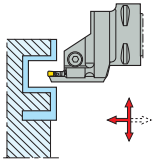

- For inserts program, see page(s) 839-844, 854-855
- For more information on Jetstream Tooling® (High pressure coolant) and accessories, please see page(s) 38, 85-89, 1002
- Initial plunge (INPLM/INPLX) relates to face groove diameter, see page(s) 705
- CTMS = Seco-Capto™ size
- CTWS = Insert shape and size
- ** Max depth of cut for double-sided LCGF/LCMF16.. = 14 mm / 0.551 inch, LCGF/LCMF30.. = 28 mm / 1.102 inch
- *** Max coolant pressure
- CDX = 3 x CW
- Right-hand version with left-hand blade shown
- Please check availability at www.secotools.com / Seco Online Store

Designation	Item number	CTMS	INPLM		INPLX		DCSFMS	WF	LF	CDX**	CP***	Weight	CW	TQ	CTWS								
			mm	Inch	mm	Inch										mm	Inch						
C4-CFIR-27060-03L080055-JET	02718475	C4	55,0	2.165	80,0	3.150	40,0	1.575	27,0	1.063	60	2.362	9,0	0.354	70,0	1015.3	0,5	1.100	3,0	0.118	5,0	44.3	LC..1603..
C4-CFIR-27060-03L100070-JET	02718476	C4	70,0	2.756	100,0	3.937	40,0	1.575	27,0	1.063	60	2.362	9,0	0.354	70,0	1015.3	0,5	1.100	3,0	0.118	5,0	44.3	LC..1603..
C4-CFIR-27060-03L130090-JET	02718477	C4	90,0	3.543	130,0	5.118	40,0	1.575	27,0	1.063	60	2.362	9,0	0.354	70,0	1015.3	0,5	1.100	3,0	0.118	5,0	44.3	LC..1603..
C4-CFIR-27060-03L170110-JET	02718478	C4	110,0	4.331	170,0	6.693	40,0	1.575	27,0	1.063	60	2.362	9,0	0.354	70,0	1015.3	0,4	0.880	3,0	0.118	5,0	44.3	LC..1603..
C4-CFIL-27060-03R080055-JET	02717469	C4	55,0	2.165	80,0	3.150	40,0	1.575	27,0	1.063	60	2.362	9,0	0.354	70,0	1015.3	0,5	1.100	3,0	0.118	5,0	44.3	LC..1603..
C4-CFIL-27060-03R100070-JET	02718462	C4	70,0	2.756	100,0	3.937	40,0	1.575	27,0	1.063	60	2.362	9,0	0.354	70,0	1015.3	0,5	1.100	3,0	0.118	5,0	44.3	LC..1603..
C4-CFIL-27060-03R130090-JET	02718463	C4	90,0	3.543	130,0	5.118	40,0	1.575	27,0	1.063	60	2.362	9,0	0.354	70,0	1015.3	0,5	1.100	3,0	0.118	5,0	44.3	LC..1603..
C4-CFIL-27060-03R170110-JET	02718464	C4	110,0	4.331	170,0	6.693	40,0	1.575	27,0	1.063	60	2.362	9,0	0.354	70,0	1015.3	0,4	0.880	3,0	0.118	5,0	44.3	LC..1603..
C4-CFIR-27065-04L080055-JET	02718479	C4	55,0	2.165	80,0	3.150	40,0	1.575	27,0	1.063	65	2.559	12,0	0.472	70,0	1015.3	0,5	1.100	4,0	0.157	5,0	44.3	LC..1604..
C4-CFIR-27065-04L100070-JET	02718480	C4	70,0	2.756	100,0	3.937	40,0	1.575	27,0	1.063	65	2.559	12,0	0.472	70,0	1015.3	0,4	0.880	4,0	0.157	5,0	44.3	LC..1604..
C4-CFIR-27065-04L130090-JET	02718481	C4	90,0	3.543	130,0	5.118	40,0	1.575	27,0	1.063	65	2.559	12,0	0.472	70,0	1015.3	0,4	0.880	4,0	0.157	5,0	44.3	LC..1604..
C4-CFIR-27065-04L170110-JET	02718482	C4	110,0	4.331	170,0	6.693	40,0	1.575	27,0	1.063	65	2.559	12,0	0.472	70,0	1015.3	0,4	0.880	4,0	0.157	5,0	44.3	LC..1604..
C4-CFIR-27065-04L230140-JET	02718483	C4	140,0	5.512	230,0	9.055	40,0	1.575	27,0	1.063	65	2.559	12,0	0.472	70,0	1015.3	0,5	1.100	4,0	0.157	5,0	44.3	LC..1604..
C4-CFIL-27065-04R080055-JET	02718465	C4	55,0	2.165	80,0	3.150	40,0	1.575	27,0	1.063	65	2.559	12,0	0.472	70,0	1015.3	0,5	1.100	4,0	0.157	5,0	44.3	LC..1604..
C4-CFIL-27065-04R100070-JET	02718466	C4	70,0	2.756	100,0	3.937	40,0	1.575	27,0	1.063	65	2.559	12,0	0.472	70,0	1015.3	0,4	0.880	4,0	0.157	5,0	44.3	LC..1604..
C4-CFIL-27065-04R130090-JET	02718467	C4	90,0	3.543	130,0	5.118	40,0	1.575	27,0	1.063	65	2.559	12,0	0.472	70,0	1015.3	0,4	0.880	4,0	0.157	5,0	44.3	LC..1604..
C4-CFIL-27065-04R170110-JET	02718468	C4	110,0	4.331	170,0	6.693	40,0	1.575	27,0	1.063	65	2.559	12,0	0.472	70,0	1015.3	0,4	0.880	4,0	0.157	5,0	44.3	LC..1604..

General ISO Turning

Steadyline®

MDT

Mini-Shaft™

Grooving

Parting-off

X4

Adapters
Clamping units

Accessories and
Spare parts

Workpiece
materials

MDT – Multi Directional Turning

Toolholders, external axial, Jetstream Tooling®, Seco-Capto™



	Designation	Item number	CTMS	INPLM	INPLX	DCSFMS	WF	LF	CDX**	CP***	Weight	CW	TQ	CTWS
				mm Inch	mm Inch	mm Inch	mm Inch	mm Inch	mm Inch	mm Inch				
General ISO Turning	C4-CFIL-27065-04R230140-JET	02718469	C4	140,0 5.512	230,0 9.055	40,0 1.575	27,0 1.063	65 2.559	12,0 0.472	70,0 1015.3	0,5 1.100	4,0 0.157	5,0 44.3	LC..1604..
	C4-CFIR-27065-05L080055-JET	02718484	C4	55,0 2.165	80,0 3.150	40,0 1.575	27,0 1.063	65 2.559	15,0 0.591	70,0 1015.3	0,5 1.100	5,0 0.197	5,0 44.3	LC..1605..
	C4-CFIR-27065-05L100070-JET	02718485	C4	70,0 2.756	100,0 3.937	40,0 1.575	27,0 1.063	65 2.559	15,0 0.591	70,0 1015.3	0,5 1.100	5,0 0.197	5,0 44.3	LC..1605..
Steadyline®	C4-CFIR-27065-05L130090-JET	02718486	C4	90,0 3.543	130,0 5.118	40,0 1.575	27,0 1.063	65 2.559	15,0 0.591	70,0 1015.3	0,5 1.100	5,0 0.197	5,0 44.3	LC..1605..
	C4-CFIR-27065-05L170110-JET	02718487	C4	110,0 4.331	170,0 6.693	40,0 1.575	27,0 1.063	65 2.559	15,0 0.591	70,0 1015.3	0,4 0.880	5,0 0.197	5,0 44.3	LC..1605..
	C4-CFIR-27065-05L230140-JET	02718488	C4	140,0 5.512	230,0 9.055	40,0 1.575	27,0 1.063	65 2.559	15,0 0.591	70,0 1015.3	0,4 0.880	5,0 0.197	5,0 44.3	LC..1605..
MDT	C4-CFIL-27065-05R080055-JET	02718470	C4	55,0 2.165	80,0 3.150	40,0 1.575	27,0 1.063	65 2.559	15,0 0.591	70,0 1015.3	0,5 1.100	5,0 0.197	5,0 44.3	LC..1605..
	C4-CFIL-27065-05R100070-JET	02718471	C4	70,0 2.756	100,0 3.937	40,0 1.575	27,0 1.063	65 2.559	15,0 0.591	70,0 1015.3	0,5 1.100	5,0 0.197	5,0 44.3	LC..1605..
	C4-CFIL-27065-05R130090-JET	02718472	C4	90,0 3.543	130,0 5.118	40,0 1.575	27,0 1.063	65 2.559	15,0 0.591	70,0 1015.3	0,5 1.100	5,0 0.197	5,0 44.3	LC..1605..
Mini-Shaft™	C4-CFIL-27065-05R170110-JET	02718473	C4	110,0 4.331	170,0 6.693	40,0 1.575	27,0 1.063	65 2.559	15,0 0.591	70,0 1015.3	0,4 0.880	5,0 0.197	5,0 44.3	LC..1605..
	C4-CFIL-27065-05R230140-JET	02718474	C4	140,0 5.512	230,0 9.055	40,0 1.575	27,0 1.063	65 2.559	15,0 0.591	70,0 1015.3	0,4 0.880	5,0 0.197	5,0 44.3	LC..1605..
	C5-CFIR-35060-03L080055-JET	02718508	C5	55,0 2.165	80,0 3.150	50,0 1.969	35,0 1.378	60 2.362	9,0 0.354	70,0 1015.3	0,7 1.540	3,0 0.118	5,0 44.3	LC..1603..
Grooving	C5-CFIR-35060-03L100070-JET	02718509	C5	70,0 2.756	100,0 3.937	50,0 1.969	35,0 1.378	60 2.362	9,0 0.354	70,0 1015.3	0,6 1.320	3,0 0.118	5,0 44.3	LC..1603..
	C5-CFIR-35060-03L130090-JET	02718510	C5	90,0 3.543	130,0 5.118	50,0 1.969	35,0 1.378	60 2.362	9,0 0.354	70,0 1015.3	0,7 1.540	3,0 0.118	5,0 44.3	LC..1603..
	C5-CFIR-35060-03L170110-JET	02718511	C5	110,0 4.331	170,0 6.693	50,0 1.969	35,0 1.378	60 2.362	9,0 0.354	70,0 1015.3	0,6 1.320	3,0 0.118	5,0 44.3	LC..1603..
Parting-off	C5-CFIL-35060-03R080055-JET	02718489	C5	55,0 2.165	80,0 3.150	50,0 1.969	35,0 1.378	60 2.362	9,0 0.354	70,0 1015.3	0,7 1.540	3,0 0.118	5,0 44.3	LC..1603..
	C5-CFIL-35060-03R100070-JET	02718490	C5	70,0 2.756	100,0 3.937	50,0 1.969	35,0 1.378	60 2.362	9,0 0.354	70,0 1015.3	0,6 1.320	3,0 0.118	5,0 44.3	LC..1603..
	C5-CFIL-35060-03R130090-JET	02718491	C5	90,0 3.543	130,0 5.118	50,0 1.969	35,0 1.378	60 2.362	9,0 0.354	70,0 1015.3	0,7 1.540	3,0 0.118	5,0 44.3	LC..1603..
X4	C5-CFIL-35060-03R170110-JET	02718492	C5	110,0 4.331	170,0 6.693	50,0 1.969	35,0 1.378	60 2.362	9,0 0.354	70,0 1015.3	0,6 1.320	3,0 0.118	5,0 44.3	LC..1603..
	C5-CFIR-35065-04L080055-JET	02718512	C5	55,0 2.165	80,0 3.150	50,0 1.969	35,0 1.378	65 2.559	12,0 0.472	70,0 1015.3	0,7 1.540	4,0 0.157	5,0 44.3	LC..1604..
	C5-CFIR-35065-04L100070-JET	02718513	C5	70,0 2.756	100,0 3.937	50,0 1.969	35,0 1.378	65 2.559	12,0 0.472	70,0 1015.3	0,6 1.320	4,0 0.157	5,0 44.3	LC..1604..
Adapters Clamping units	C5-CFIR-35065-04L130090-JET	02718514	C5	90,0 3.543	130,0 5.118	50,0 1.969	35,0 1.378	65 2.559	12,0 0.472	70,0 1015.3	0,7 1.540	4,0 0.157	5,0 44.3	LC..1604..
	C5-CFIR-35065-04L170110-JET	02718515	C5	110,0 4.331	170,0 6.693	50,0 1.969	35,0 1.378	65 2.559	12,0 0.472	70,0 1015.3	0,7 1.540	4,0 0.157	5,0 44.3	LC..1604..
	C5-CFIL-35065-04L230140-JET	02718516	C5	140,0 5.512	230,0 9.055	50,0 1.969	35,0 1.378	65 2.559	12,0 0.472	70,0 1015.3	0,7 1.540	4,0 0.157	5,0 44.3	LC..1604..
Accessories and Spare parts	C5-CFIL-35065-04R080055-JET	02718493	C5	55,0 2.165	80,0 3.150	50,0 1.969	35,0 1.378	65 2.559	12,0 0.472	70,0 1015.3	0,7 1.540	4,0 0.157	5,0 44.3	LC..1604..
	C5-CFIL-35065-04R100070-JET	02718494	C5	70,0 2.756	100,0 3.937	50,0 1.969	35,0 1.378	65 2.559	12,0 0.472	70,0 1015.3	0,6 1.320	4,0 0.157	5,0 44.3	LC..1604..
	C5-CFIL-35065-04R130090-JET	02718495	C5	90,0 3.543	130,0 5.118	50,0 1.969	35,0 1.378	65 2.559	12,0 0.472	70,0 1015.3	0,7 1.540	4,0 0.157	5,0 44.3	LC..1604..
Workpiece materials	C5-CFIL-35065-04R170110-JET	02718496	C5	110,0 4.331	170,0 6.693	50,0 1.969	35,0 1.378	65 2.559	12,0 0.472	70,0 1015.3	0,7 1.540	4,0 0.157	5,0 44.3	LC..1604..
	C5-CFIL-35065-04R230140-JET	02718497	C5	140,0 5.512	230,0 9.055	50,0 1.969	35,0 1.378	65 2.559	12,0 0.472	70,0 1015.3	0,7 1.540	4,0 0.157	5,0 44.3	LC..1604..
	C5-CFIR-35065-05L080055-JET	02718517	C5	55,0 2.165	80,0 3.150	50,0 1.969	35,0 1.378	65 2.559	15,0 0.591	70,0 1015.3	0,7 1.540	5,0 0.197	5,0 44.3	LC..1605..
	C5-CFIR-35065-05L100070-JET	02718518	C5	70,0 2.756	100,0 3.937	50,0 1.969	35,0 1.378	65 2.559	15,0 0.591	70,0 1015.3	0,7 1.540	5,0 0.197	5,0 44.3	LC..1605..

Designation	Item number	CTMS	INPLM	INPLX	DCSFM5	WF	LF	CDX**	CP***	Weight	CW	TQ	CTWS
			mm Inch	mm Inch	mm Inch	mm Inch	mm Inch	mm Inch	mm Inch				
C5-CFIR-35065-05L130090-JET	02718519	C5	90,0 3.543	130,0 5.118	50,0 1.969	35,0 1.378	65 2.559	15,0 0.591	70,0 1015.3	0,6 1.320	5,0 0.197	5,0 44.3	LC..1605..
C5-CFIR-35065-05L170110-JET	02718520	C5	110,0 4.331	170,0 6.693	50,0 1.969	35,0 1.378	65 2.559	15,0 0.591	70,0 1015.3	0,6 1.320	5,0 0.197	5,0 44.3	LC..1605..
C5-CFIR-35065-05L230140-JET	02718521	C5	140,0 5.512	230,0 9.055	50,0 1.969	35,0 1.378	65 2.559	15,0 0.591	70,0 1015.3	0,7 1.540	5,0 0.197	5,0 44.3	LC..1605..
C5-CFIL-35065-05R080055-JET	02718498	C5	55,0 2.165	80,0 3.150	50,0 1.969	35,0 1.378	65 2.559	15,0 0.591	70,0 1015.3	0,7 1.540	5,0 0.197	5,0 44.3	LC..1605..
C5-CFIL-35065-05R100070-JET	02718499	C5	70,0 2.756	100,0 3.937	50,0 1.969	35,0 1.378	65 2.559	15,0 0.591	70,0 1015.3	0,7 1.540	5,0 0.197	5,0 44.3	LC..1605..
C5-CFIL-35065-05R130090-JET	02718500	C5	90,0 3.543	130,0 5.118	50,0 1.969	35,0 1.378	65 2.559	15,0 0.591	70,0 1015.3	0,6 1.320	5,0 0.197	5,0 44.3	LC..1605..
C5-CFIL-35065-05R170110-JET	02718501	C5	110,0 4.331	170,0 6.693	50,0 1.969	35,0 1.378	65 2.559	15,0 0.591	70,0 1015.3	0,6 1.320	5,0 0.197	5,0 44.3	LC..1605..
C5-CFIL-35065-05R230140-JET	02718502	C5	140,0 5.512	230,0 9.055	50,0 1.969	35,0 1.378	65 2.559	15,0 0.591	70,0 1015.3	0,7 1.540	5,0 0.197	5,0 44.3	LC..1605..
C5-CFIR-35075-06L080055-JET	02718522	C5	55,0 2.165	80,0 3.150	50,0 1.969	35,0 1.378	75 2.953	18,0 0.709	70,0 1015.3	0,8 1.760	6,0 0.236	5,0 44.3	LC..1606..
C5-CFIR-35075-06L100070-JET	02718523	C5	70,0 2.756	100,0 3.937	50,0 1.969	35,0 1.378	75 2.953	18,0 0.709	70,0 1015.3	0,6 1.320	6,0 0.236	5,0 44.3	LC..1606..
C5-CFIR-35075-06L130090-JET	02718524	C5	90,0 3.543	130,0 5.118	50,0 1.969	35,0 1.378	75 2.953	18,0 0.709	70,0 1015.3	0,8 1.760	6,0 0.236	5,0 44.3	LC..1606..
C5-CFIR-35075-06L170110-JET	02718525	C5	110,0 4.331	170,0 6.693	50,0 1.969	35,0 1.378	75 2.953	18,0 0.709	70,0 1015.3	0,6 1.320	6,0 0.236	5,0 44.3	LC..1606..
C5-CFIR-35075-06L230140-JET	02718526	C5	140,0 5.512	230,0 9.055	50,0 1.969	35,0 1.378	75 2.953	18,0 0.709	70,0 1015.3	0,8 1.760	6,0 0.236	5,0 44.3	LC..1606..
C5-CFIL-35075-06R080055-JET	02718503	C5	55,0 2.165	80,0 3.150	50,0 1.969	35,0 1.378	75 2.953	18,0 0.709	70,0 1015.3	0,8 1.760	6,0 0.236	5,0 44.3	LC..1606..
C5-CFIL-35075-06R100070-JET	02718504	C5	70,0 2.756	100,0 3.937	50,0 1.969	35,0 1.378	75 2.953	18,0 0.709	70,0 1015.3	0,6 1.320	6,0 0.236	5,0 44.3	LC..1606..
C5-CFIL-35075-06R130090-JET	02718505	C5	90,0 3.543	130,0 5.118	50,0 1.969	35,0 1.378	75 2.953	18,0 0.709	70,0 1015.3	0,8 1.760	6,0 0.236	5,0 44.3	LC..1606..
C5-CFIL-35075-06R170110-JET	02718506	C5	110,0 4.331	170,0 6.693	50,0 1.969	35,0 1.378	75 2.953	18,0 0.709	70,0 1015.3	0,6 1.320	6,0 0.236	5,0 44.3	LC..1606..
C5-CFIL-35075-06R230140-JET	02718507	C5	140,0 5.512	230,0 9.055	50,0 1.969	35,0 1.378	75 2.953	18,0 0.709	70,0 1015.3	0,8 1.760	6,0 0.236	5,0 44.3	LC..1606..
C6-CFIR-45065-03L080055-JET	02718550	C6	55,0 2.165	80,0 3.150	63,0 2.480	45,0 1.772	65 2.559	9,0 0.354	70,0 1015.3	1,1 2.430	3,0 0.118	5,0 44.3	LC..1603..
C6-CFIR-45065-03L100070-JET	02718551	C6	70,0 2.756	100,0 3.937	63,0 2.480	45,0 1.772	65 2.559	9,0 0.354	70,0 1015.3	1,1 2.430	3,0 0.118	5,0 44.3	LC..1603..
C6-CFIR-45065-03L130090-JET	02718552	C6	90,0 3.543	130,0 5.118	63,0 2.480	45,0 1.772	65 2.559	9,0 0.354	70,0 1015.3	1,1 2.430	3,0 0.118	5,0 44.3	LC..1603..
C6-CFIR-45065-03L170110-JET	02718553	C6	110,0 4.331	170,0 6.693	63,0 2.480	45,0 1.772	65 2.559	9,0 0.354	70,0 1015.3	1,1 2.430	3,0 0.118	5,0 44.3	LC..1603..
C6-CFIL-45065-03R080055-JET	02718527	C6	55,0 2.165	80,0 3.150	63,0 2.480	45,0 1.772	65 2.559	9,0 0.354	70,0 1015.3	1,1 2.430	3,0 0.118	5,0 44.3	LC..1603..
C6-CFIL-45065-03R100070-JET	02718528	C6	70,0 2.756	100,0 3.937	63,0 2.480	45,0 1.772	65 2.559	9,0 0.354	70,0 1015.3	1,1 2.430	3,0 0.118	5,0 44.3	LC..1603..
C6-CFIL-45065-03R130090-JET	02718529	C6	90,0 3.543	130,0 5.118	63,0 2.480	45,0 1.772	65 2.559	9,0 0.354	70,0 1015.3	1,1 2.430	3,0 0.118	5,0 44.3	LC..1603..
C6-CFIL-45065-03R170110-JET	02718530	C6	110,0 4.331	170,0 6.693	63,0 2.480	45,0 1.772	65 2.559	9,0 0.354	70,0 1015.3	1,1 2.430	3,0 0.118	5,0 44.3	LC..1603..
C6-CFIR-45065-04L080055-JET	02718554	C6	55,0 2.165	80,0 3.150	63,0 2.480	45,0 1.772	65 2.559	12,0 0.472	70,0 1015.3	1,1 2.430	4,0 0.157	5,0 44.3	LC..1604..
C6-CFIR-45065-04L100070-JET	02718555	C6	70,0 2.756	100,0 3.937	63,0 2.480	45,0 1.772	65 2.559	12,0 0.472	70,0 1015.3	1,1 2.430	4,0 0.157	5,0 44.3	LC..1604..
C6-CFIR-45065-04L130090-JET	02718556	C6	90,0 3.543	130,0 5.118	63,0 2.480	45,0 1.772	65 2.559	12,0 0.472	70,0 1015.3	1,1 2.430	4,0 0.157	5,0 44.3	LC..1604..
C6-CFIR-45065-04L170110-JET	02718557	C6	110,0 4.331	170,0 6.693	63,0 2.480	45,0 1.772	65 2.559	12,0 0.472	70,0 1015.3	1,1 2.430	4,0 0.157	5,0 44.3	LC..1604..
C6-CFIR-45065-04L230140-JET	02718558	C6	140,0 5.512	230,0 9.055	63,0 2.480	45,0 1.772	65 2.559	12,0 0.472	70,0 1015.3	1,1 2.430	4,0 0.157	5,0 44.3	LC..1604..

General ISO Turning
Steadyline®
MDT
Mini-Shaft™
Grooving
Parting-off
X4
Adapters
Clamping units
Accessories and Spare parts
Workpiece materials

MDT – Multi Directional Turning

Toolholders, external axial, Jetstream Tooling®, Seco-Capto™



	Designation	Item number	CTMS	INPLM	INPLX	DCSFMS	WF	LF	CDX**	CP***	Weight	CW	TQ	CTWS
				mm Inch	mm Inch	mm Inch	mm Inch	mm Inch	mm Inch	mm Inch	bar psi	kg lbs	mm Inch	Nm In/Lbs.
General ISO Turning	C6-CFIL-45065-04R080055-JET	02718531	C6	55,0 2.165	80,0 3.150	63,0 2.480	45,0 1.772	65 2.559	12,0 0.472	70,0 1015.3	1,1 2.430	4,0 0.157	5,0 44.3	LC..1604..
	C6-CFIL-45065-04R100070-JET	02718532	C6	70,0 2.756	100,0 3.937	63,0 2.480	45,0 1.772	65 2.559	12,0 0.472	70,0 1015.3	1,1 2.430	4,0 0.157	5,0 44.3	LC..1604..
	C6-CFIL-45065-04R130090-JET	02718533	C6	90,0 3.543	130,0 5.118	63,0 2.480	45,0 1.772	65 2.559	12,0 0.472	70,0 1015.3	1,1 2.430	4,0 0.157	5,0 44.3	LC..1604..
Steadyline®	C6-CFIL-45065-04R170110-JET	02718534	C6	110,0 4.331	170,0 6.693	63,0 2.480	45,0 1.772	65 2.559	12,0 0.472	70,0 1015.3	1,1 2.430	4,0 0.157	5,0 44.3	LC..1604..
	C6-CFIL-45065-04R230140-JET	02718535	C6	140,0 5.512	230,0 9.055	63,0 2.480	45,0 1.772	65 2.559	12,0 0.472	70,0 1015.3	1,1 2.430	4,0 0.157	5,0 44.3	LC..1604..
	C6-CFIR-45070-05L080055-JET	02718559	C6	55,0 2.165	80,0 3.150	63,0 2.480	45,0 1.772	70 2.756	15,0 0.591	70,0 1015.3	1,1 2.430	5,0 0.197	5,0 44.3	LC..1605..
MDT	C6-CFIR-45070-05L100070-JET	02718560	C6	70,0 2.756	100,0 3.937	63,0 2.480	45,0 1.772	70 2.756	15,0 0.591	70,0 1015.3	1,1 2.430	5,0 0.197	5,0 44.3	LC..1605..
	C6-CFIR-45070-05L130090-JET	02718561	C6	90,0 3.543	130,0 5.118	63,0 2.480	45,0 1.772	70 2.756	15,0 0.591	70,0 1015.3	1,1 2.430	5,0 0.197	5,0 44.3	LC..1605..
	C6-CFIR-45070-05L170110-JET	02718562	C6	110,0 4.331	170,0 6.693	63,0 2.480	45,0 1.772	70 2.756	15,0 0.591	70,0 1015.3	1,1 2.430	5,0 0.197	5,0 44.3	LC..1605..
Mini-Shaft™	C6-CFIL-45070-05L230140-JET	02718563	C6	140,0 5.512	230,0 9.055	63,0 2.480	45,0 1.772	70 2.756	15,0 0.591	70,0 1015.3	1,1 2.430	5,0 0.197	5,0 44.3	LC..1605..
	C6-CFIL-45070-05R080055-JET	02718536	C6	55,0 2.165	80,0 3.150	63,0 2.480	45,0 1.772	70 2.756	15,0 0.591	70,0 1015.3	1,1 2.430	5,0 0.197	5,0 44.3	LC..1605..
	C6-CFIL-45070-05R100070-JET	02718537	C6	70,0 2.756	100,0 3.937	63,0 2.480	45,0 1.772	70 2.756	15,0 0.591	70,0 1015.3	1,1 2.430	5,0 0.197	5,0 44.3	LC..1605..
Grooving	C6-CFIL-45070-05R130090-JET	02718538	C6	90,0 3.543	130,0 5.118	63,0 2.480	45,0 1.772	70 2.756	15,0 0.591	70,0 1015.3	1,1 2.430	5,0 0.197	5,0 44.3	LC..1605..
	C6-CFIL-45070-05R170110-JET	02718539	C6	110,0 4.331	170,0 6.693	63,0 2.480	45,0 1.772	70 2.756	15,0 0.591	70,0 1015.3	1,1 2.430	5,0 0.197	5,0 44.3	LC..1605..
	C6-CFIL-45070-05R230140-JET	02718540	C6	140,0 5.512	230,0 9.055	63,0 2.480	45,0 1.772	70 2.756	15,0 0.591	70,0 1015.3	1,1 2.430	5,0 0.197	5,0 44.3	LC..1605..
Parting-off	C6-CFIR-45075-06L080055-JET	02718564	C6	55,0 2.165	80,0 3.150	63,0 2.480	45,0 1.772	75 2.953	18,0 0.709	70,0 1015.3	1,1 2.430	6,0 0.236	5,0 44.3	LC..1606..
	C6-CFIR-45075-06L100070-JET	02718565	C6	70,0 2.756	100,0 3.937	63,0 2.480	45,0 1.772	75 2.953	18,0 0.709	70,0 1015.3	1,1 2.430	6,0 0.236	5,0 44.3	LC..1606..
	C6-CFIR-45075-06L130090-JET	02718566	C6	90,0 3.543	130,0 5.118	63,0 2.480	45,0 1.772	75 2.953	18,0 0.709	70,0 1015.3	1,1 2.430	6,0 0.236	5,0 44.3	LC..1606..
X4	C6-CFIR-45075-06L170110-JET	02718567	C6	110,0 4.331	170,0 6.693	63,0 2.480	45,0 1.772	75 2.953	18,0 0.709	70,0 1015.3	1,1 2.430	6,0 0.236	5,0 44.3	LC..1606..
	C6-CFIL-45075-06L230140-JET	02718568	C6	140,0 5.512	230,0 9.055	63,0 2.480	45,0 1.772	75 2.953	18,0 0.709	70,0 1015.3	1,1 2.430	6,0 0.236	5,0 44.3	LC..1606..
	C6-CFIL-45075-06R080055-JET	02718541	C6	55,0 2.165	80,0 3.150	63,0 2.480	45,0 1.772	75 2.953	18,0 0.709	70,0 1015.3	1,1 2.430	6,0 0.236	5,0 44.3	LC..1606..
Adapters Clamping units	C6-CFIL-45075-06R100070-JET	02718542	C6	70,0 2.756	100,0 3.937	63,0 2.480	45,0 1.772	75 2.953	18,0 0.709	70,0 1015.3	1,1 2.430	6,0 0.236	5,0 44.3	LC..1606..
	C6-CFIL-45075-06R130090-JET	02718543	C6	90,0 3.543	130,0 5.118	63,0 2.480	45,0 1.772	75 2.953	18,0 0.709	70,0 1015.3	1,1 2.430	6,0 0.236	5,0 44.3	LC..1606..
	C6-CFIL-45075-06R170110-JET	02718544	C6	110,0 4.331	170,0 6.693	63,0 2.480	45,0 1.772	75 2.953	18,0 0.709	70,0 1015.3	1,1 2.430	6,0 0.236	5,0 44.3	LC..1606..
Accessories and Spare parts	C6-CFIL-45075-06R230140-JET	02718545	C6	140,0 5.512	230,0 9.055	63,0 2.480	45,0 1.772	75 2.953	18,0 0.709	70,0 1015.3	1,1 2.430	6,0 0.236	5,0 44.3	LC..1606..
	C6-CFIR-45085-08L130090-JET	02718569	C6	90,0 3.543	130,0 5.118	63,0 2.480	45,0 1.772	85 3.346	24,0 0.945	70,0 1015.3	1,2 2.650	8,0 0.315	5,0 44.3	LC..3008..
	C6-CFIR-45085-08L170110-JET	02718570	C6	110,0 4.331	170,0 6.693	63,0 2.480	45,0 1.772	85 3.346	24,0 0.945	70,0 1015.3	1,2 2.650	8,0 0.315	5,0 44.3	LC..3008..
Workpiece materials	C6-CFIR-45085-08L230140-JET	02718571	C6	140,0 5.512	230,0 9.055	63,0 2.480	45,0 1.772	85 3.346	24,0 0.945	70,0 1015.3	1,2 2.650	8,0 0.315	5,0 44.3	LC..3008..
	C6-CFIR-45085-08L500200-JET	02718572	C6	200,0 7.874	500,0 19.685	63,0 2.480	45,0 1.772	85 3.346	24,0 0.945	70,0 1015.3	1,2 2.650	8,0 0.315	5,0 44.3	LC..3008..
	C6-CFIL-45085-08R130090-JET	02718546	C6	90,0 3.543	130,0 5.118	63,0 2.480	45,0 1.772	85 3.346	24,0 0.945	70,0 1015.3	1,2 2.650	8,0 0.315	10,0 88.5	LC..3008..
	C6-CFIL-45085-08R170110-JET	02718547	C6	110,0 4.331	170,0 6.693	63,0 2.480	45,0 1.772	85 3.346	24,0 0.945	70,0 1015.3	1,2 2.650	8,0 0.315	10,0 88.5	LC..3008..

Designation	Item number	CTMS	INPLM	INPLX	DCSFMS	WF	LF	CDX**	CP***	Weight	CW	TQ	CTWS
			mm Inch	mm Inch	mm Inch	mm Inch	mm Inch	mm Inch	bar psi	kg lbs	mm Inch	Nm In/Lbs.	
C6-CFIL-45085-08R230140-JET	02718548	C6	140,0 5.512	230,0 9.055	63,0 2.480	45,0 1.772	85 3.346	24,0 0.945	70,0 1015.3	1,2 2.650	8,0 0.315	10,0 88.5	LC..3008..
C6-CFIL-45085-08R500200-JET	02718549	C6	200,0 7.874	500,0 19.685	63,0 2.480	45,0 1.772	85 3.346	24,0 0.945	70,0 1015.3	1,2 2.650	8,0 0.315	10,0 88.5	LC..3008..

Spare Parts

For size	Clamp key	Clamp screw
		
CFIR/L..-03	4SMS795	TCEI0513
CFIR/L..-04	5SMS795	TCEI0613
CFIR/L..-05	5SMS795	TCEI0613
CFIR/L..-06	6SMS795	TCEI0815
CFIR/L..-08	6SMS795	TCEI1020

General ISO Turning

Steadyline®

MDT

Mini-Shaft™

Grooving

Parting-off

X4

Adapters
Clamping units

Accessories and
Spare parts

Workpiece
materials

General ISO Turning

Steadyline®

MDT

Mini-Shaft™

Grooving

Parting-off

X4

Adapters
Clamping units

Accessories and
Spare parts

Workpiece
materials

C-CFOR...L...JET, C-CFOL...R...JET – Toolholders for inserts LCGF, LCGN, LCMF and LCMR – Metric/ Inch



CTWS

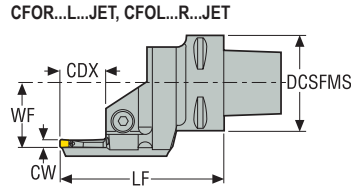

C-CFOR/L
KAPR = 90,0 °

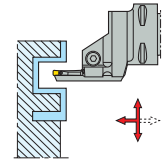

- For inserts program, see page(s) 839-844, 854-855
- For more information on Jetstream Tooling® (High pressure coolant) and accessories, please see page(s) 38, 85-89, 1002
- Initial plunge (INPLM/INPLX) relates to face groove diameter, see page(s) 705
- CTMS = Seco-Capto™ size
- CTWS = Insert shape and size
- ** Max depth of cut for double-sided LCGF/LCMF16.. = 14 mm / 0.551 inch, LCGF/LCMF30.. = 28 mm / 1.102 inch
- *** Max coolant pressure
- CDX = 6 x CW
- Right-hand version with left-hand blade shown
- Please check availability at www.secotools.com / Seco Online Store

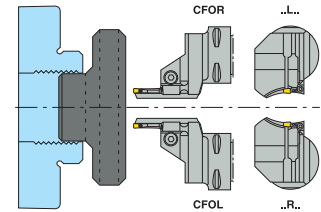

Designation	Item number	CTMS	INPLM		INPLX		DCSFMS	WF	LF	CDX**	CP***	Weight	CW	TQ	CTWS				
			mm	Inch	mm	Inch										mm	Inch	bar	kg
C4-CFOR-27070-03L080055-JET	02718585	C4	55,0	2.165	80,0	3.150	40,0	1.575	27,0	1.063	70	2.756	0,5	1.100	3,0	0,118	5,0	44,3	LC..1603..
C4-CFOR-27070-03L100070-JET	02718586	C4	70,0	2.756	100,0	3.937	40,0	1.575	27,0	1.063	70	2.756	0,5	1.100	3,0	0,118	5,0	44,3	LC..1603..
C4-CFOR-27070-03L130090-JET	02718587	C4	90,0	3.543	130,0	5.118	40,0	1.575	27,0	1.063	70	2.756	0,5	1.100	3,0	0,118	5,0	44,3	LC..1603..
C4-CFOR-27070-03L170110-JET	02718588	C4	110,0	4.331	170,0	6.693	40,0	1.575	27,0	1.063	70	2.756	0,5	1.100	3,0	0,118	5,0	44,3	LC..1603..
C4-CFOR-27070-03L230140-JET	02718589	C4	140,0	5.512	230,0	9.055	40,0	1.575	27,0	1.063	70	2.756	0,5	1.100	3,0	0,118	5,0	44,3	LC..1603..
C4-CFOR-27070-03L500200-JET	02718590	C4	200,0	7.874	500,0	19.685	40,0	1.575	27,0	1.063	70	2.756	0,5	1.100	3,0	0,118	5,0	44,3	LC..1603..
C4-CFOL-27070-03R080055-JET	02718573	C4	55,0	2.165	80,0	3.150	40,0	1.575	27,0	1.063	70	2.756	0,5	1.100	3,0	0,118	5,0	44,3	LC..1603..
C4-CFOL-27070-03R100070-JET	02718574	C4	70,0	2.756	100,0	3.937	40,0	1.575	27,0	1.063	70	2.756	0,5	1.100	3,0	0,118	5,0	44,3	LC..1603..
C4-CFOL-27070-03R130090-JET	02718575	C4	90,0	3.543	130,0	5.118	40,0	1.575	27,0	1.063	70	2.756	0,5	1.100	3,0	0,118	5,0	44,3	LC..1603..
C4-CFOL-27070-03R170110-JET	02718576	C4	110,0	4.331	170,0	6.693	40,0	1.575	27,0	1.063	70	2.756	0,5	1.100	3,0	0,118	5,0	44,3	LC..1603..
C4-CFOL-27070-03R230140-JET	02718577	C4	140,0	5.512	230,0	9.055	40,0	1.575	27,0	1.063	70	2.756	0,5	1.100	3,0	0,118	5,0	44,3	LC..1603..
C4-CFOL-27070-03R500200-JET	02718578	C4	200,0	7.874	500,0	19.685	40,0	1.575	27,0	1.063	70	2.756	0,5	1.100	3,0	0,118	5,0	44,3	LC..1603..
C4-CFOR-27080-04L080055-JET	02718591	C4	55,0	2.165	80,0	3.150	40,0	1.575	27,0	1.063	80	3.150	0,5	1.100	4,0	0,157	5,0	44,3	LC..1604..
C4-CFOR-27080-04L100070-JET	02718592	C4	70,0	2.756	100,0	3.937	40,0	1.575	27,0	1.063	80	3.150	0,5	1.100	4,0	0,157	5,0	44,3	LC..1604..
C4-CFOR-27080-04L130090-JET	02718593	C4	90,0	3.543	130,0	5.118	40,0	1.575	27,0	1.063	80	3.150	0,5	1.100	4,0	0,157	5,0	44,3	LC..1604..
C4-CFOR-27080-04L170110-JET	02718594	C4	110,0	4.331	170,0	6.693	40,0	1.575	27,0	1.063	80	3.150	0,5	1.100	4,0	0,157	5,0	44,3	LC..1604..
C4-CFOR-27080-04L230140-JET	02718595	C4	140,0	5.512	230,0	9.055	40,0	1.575	27,0	1.063	80	3.150	0,5	1.100	4,0	0,157	5,0	44,3	LC..1604..

Designation	Item number	CTMS	INPLM		INPLX		DCSFM5	WF	LF	CDX**	CP***	Weight	CW	TQ	CTWS
			mm Inch	mm Inch	mm Inch	mm Inch									
C4-CFOR-27080-04L500200-JET	02718596	C4	200,0 7.874	500,0 19.685	40,0 1.575	27,0 1.063	80 3.150	24,0 0.945	70,0 1015.3	0,5 1.100	4,0 0.157	5,0 44.3	LC..1604..		
C4-CFOL-27080-04R080055-JET	02714035	C4	55,0 2.165	80,0 3.150	40,0 1.575	27,0 1.063	80 3.150	24,0 0.945	70,0 1015.3	0,5 1.100	4,0 0.157	5,0 44.3	LC..1604..		
C4-CFOL-27080-04R100070-JET	02714037	C4	70,0 2.756	100,0 3.937	40,0 1.575	27,0 1.063	80 3.150	24,0 0.945	70,0 1015.3	0,5 1.100	4,0 0.157	5,0 44.3	LC..1604..		
C4-CFOL-27080-04R130090-JET	02714038	C4	90,0 3.543	130,0 5.118	40,0 1.575	27,0 1.063	80 3.150	24,0 0.945	70,0 1015.3	0,5 1.100	4,0 0.157	5,0 44.3	LC..1604..		
C4-CFOL-27080-04R170110-JET	02714039	C4	110,0 4.331	170,0 6.693	40,0 1.575	27,0 1.063	80 3.150	24,0 0.945	70,0 1015.3	0,5 1.100	4,0 0.157	5,0 44.3	LC..1604..		
C4-CFOL-27080-04R230140-JET	02714041	C4	140,0 5.512	230,0 9.055	40,0 1.575	27,0 1.063	80 3.150	24,0 0.945	70,0 1015.3	0,5 1.100	4,0 0.157	5,0 44.3	LC..1604..		
C4-CFOL-27080-04R500200-JET	02714042	C4	200,0 7.874	500,0 19.685	40,0 1.575	27,0 1.063	80 3.150	24,0 0.945	70,0 1015.3	0,5 1.100	4,0 0.157	5,0 44.3	LC..1604..		
C4-CFOR-27085-05L080055-JET	02718597	C4	55,0 2.165	80,0 3.150	40,0 1.575	27,0 1.063	85 3.346	30,0 1.181	70,0 1015.3	0,5 1.100	5,0 0.197	5,0 44.3	LC..1605..		
C4-CFOR-27085-05L100070-JET	02718598	C4	70,0 2.756	100,0 3.937	40,0 1.575	27,0 1.063	85 3.346	30,0 1.181	70,0 1015.3	0,5 1.100	5,0 0.197	5,0 44.3	LC..1605..		
C4-CFOR-27085-05L130090-JET	02718599	C4	90,0 3.543	130,0 5.118	40,0 1.575	27,0 1.063	85 3.346	30,0 1.181	70,0 1015.3	0,5 1.100	5,0 0.197	5,0 44.3	LC..1605..		
C4-CFOR-27085-05L170110-JET	02718600	C4	110,0 4.331	170,0 6.693	40,0 1.575	27,0 1.063	85 3.346	30,0 1.181	70,0 1015.3	0,5 1.100	5,0 0.197	5,0 44.3	LC..1605..		
C4-CFOR-27085-05L230140-JET	02718601	C4	140,0 5.512	230,0 9.055	40,0 1.575	27,0 1.063	85 3.346	30,0 1.181	70,0 1015.3	0,5 1.100	5,0 0.197	5,0 44.3	LC..1605..		
C4-CFOR-27085-05L500200-JET	02718602	C4	200,0 7.874	500,0 19.685	40,0 1.575	27,0 1.063	85 3.346	30,0 1.181	70,0 1015.3	0,5 1.100	5,0 0.197	5,0 44.3	LC..1605..		
C4-CFOL-27085-05R080055-JET	02718579	C4	55,0 2.165	80,0 3.150	40,0 1.575	27,0 1.063	85 3.346	30,0 1.181	70,0 1015.3	0,5 1.100	5,0 0.197	5,0 44.3	LC..1605..		
C4-CFOL-27085-05R100070-JET	02718580	C4	70,0 2.756	100,0 3.937	40,0 1.575	27,0 1.063	85 3.346	30,0 1.181	70,0 1015.3	0,5 1.100	5,0 0.197	5,0 44.3	LC..1605..		
C4-CFOL-27085-05R130090-JET	02718581	C4	90,0 3.543	130,0 5.118	40,0 1.575	27,0 1.063	85 3.346	30,0 1.181	70,0 1015.3	0,5 1.100	5,0 0.197	5,0 44.3	LC..1605..		
C4-CFOL-27085-05R170110-JET	02718582	C4	110,0 4.331	170,0 6.693	40,0 1.575	27,0 1.063	85 3.346	30,0 1.181	70,0 1015.3	0,5 1.100	5,0 0.197	5,0 44.3	LC..1605..		
C4-CFOL-27085-05R230140-JET	02718583	C4	140,0 5.512	230,0 9.055	40,0 1.575	27,0 1.063	85 3.346	30,0 1.181	70,0 1015.3	0,5 1.100	5,0 0.197	5,0 44.3	LC..1605..		
C4-CFOL-27085-05R500200-JET	02718584	C4	200,0 7.874	500,0 19.685	40,0 1.575	27,0 1.063	85 3.346	30,0 1.181	70,0 1015.3	0,5 1.100	5,0 0.197	5,0 44.3	LC..1605..		
C5-CFOR-35070-03L080055-JET	02718627	C5	55,0 2.165	80,0 3.150	50,0 1.969	35,0 1.378	70 2.756	18,0 0.709	70,0 1015.3	0,7 1.540	3,0 0.118	5,0 44.3	LC..1603..		
C5-CFOR-35070-03L100070-JET	02718628	C5	70,0 2.756	100,0 3.937	50,0 1.969	35,0 1.378	70 2.756	18,0 0.709	70,0 1015.3	0,7 1.540	3,0 0.118	5,0 44.3	LC..1603..		
C5-CFOR-35070-03L130090-JET	02718629	C5	90,0 3.543	130,0 5.118	50,0 1.969	35,0 1.378	70 2.756	18,0 0.709	70,0 1015.3	0,7 1.540	3,0 0.118	5,0 44.3	LC..1603..		
C5-CFOR-35070-03L170110-JET	02718630	C5	110,0 4.331	170,0 6.693	50,0 1.969	35,0 1.378	70 2.756	18,0 0.709	70,0 1015.3	0,7 1.540	3,0 0.118	5,0 44.3	LC..1603..		
C5-CFOR-35070-03L230140-JET	02718631	C5	140,0 5.512	230,0 9.055	50,0 1.969	35,0 1.378	70 2.756	18,0 0.709	70,0 1015.3	0,7 1.540	3,0 0.118	5,0 44.3	LC..1603..		
C5-CFOR-35070-03L500200-JET	02718632	C5	200,0 7.874	500,0 19.685	50,0 1.969	35,0 1.378	70 2.756	18,0 0.709	70,0 1015.3	0,7 1.540	3,0 0.118	5,0 44.3	LC..1603..		
C5-CFOL-35070-03R080055-JET	02718603	C5	55,0 2.165	80,0 3.150	50,0 1.969	35,0 1.378	70 2.756	18,0 0.709	70,0 1015.3	0,7 1.540	3,0 0.118	5,0 44.3	LC..1603..		
C5-CFOL-35070-03R100070-JET	02718604	C5	70,0 2.756	100,0 3.937	50,0 1.969	35,0 1.378	70 2.756	18,0 0.709	70,0 1015.3	0,7 1.540	3,0 0.118	5,0 44.3	LC..1603..		
C5-CFOL-35070-03R130090-JET	02718605	C5	90,0 3.543	130,0 5.118	50,0 1.969	35,0 1.378	70 2.756	18,0 0.709	70,0 1015.3	0,7 1.540	3,0 0.118	5,0 44.3	LC..1603..		
C5-CFOL-35070-03R170110-JET	02718606	C5	110,0 4.331	170,0 6.693	50,0 1.969	35,0 1.378	70 2.756	18,0 0.709	70,0 1015.3	0,7 1.540	3,0 0.118	5,0 44.3	LC..1603..		
C5-CFOL-35070-03R230140-JET	02718607	C5	140,0 5.512	230,0 9.055	50,0 1.969	35,0 1.378	70 2.756	18,0 0.709	70,0 1015.3	0,7 1.540	3,0 0.118	5,0 44.3	LC..1603..		
C5-CFOL-35070-03R500200-JET	02718608	C5	200,0 7.874	500,0 19.685	50,0 1.969	35,0 1.378	70 2.756	18,0 0.709	70,0 1015.3	0,7 1.540	3,0 0.118	5,0 44.3	LC..1603..		

General ISO Turning

Steadyline®

MDT

Mini-Shaft™

Grooving

Parting-off

X4

Adapters
Clamping units

Accessories and
Spare parts

Workpiece
materials

MDT – Multi Directional Turning

Toolholders, external axial, Jetstream Tooling®, Seco-Capto™



	Designation	Item number	CTMS	INPLM	INPLX	DCSFMS	WF	LF	CDX**	CP***	Weight	CW	TQ	CTWS
				mm Inch	mm Inch	mm Inch	mm Inch	mm Inch	mm Inch	mm Inch	bar psi	kg lbs	mm Inch	Nm In/Lbs.
General ISO Turning	C5-CFOR-35080-04L080055-JET	02718633	C5	55,0 2.165	80,0 3.150	50,0 1.969	35,0 1.378	80 3.150	24,0 0.945	70,0 1015.3	0,8 1.760	4,0 0.157	5,0 44.3	LC..1604..
	C5-CFOR-35080-04L100070-JET	02718634	C5	70,0 2.756	100,0 3.937	50,0 1.969	35,0 1.378	80 3.150	24,0 0.945	70,0 1015.3	0,7 1.540	4,0 0.157	5,0 44.3	LC..1604..
	C5-CFOR-35080-04L130090-JET	02718635	C5	90,0 3.543	130,0 5.118	50,0 1.969	35,0 1.378	80 3.150	24,0 0.945	70,0 1015.3	0,8 1.760	4,0 0.157	5,0 44.3	LC..1604..
Steadyline®	C5-CFOR-35080-04L170110-JET	02718636	C5	110,0 4.331	170,0 6.693	50,0 1.969	35,0 1.378	80 3.150	24,0 0.945	70,0 1015.3	0,8 1.760	4,0 0.157	5,0 44.3	LC..1604..
	C5-CFOR-35080-04L230140-JET	02718637	C5	140,0 5.512	230,0 9.055	50,0 1.969	35,0 1.378	80 3.150	24,0 0.945	70,0 1015.3	0,8 1.760	4,0 0.157	5,0 44.3	LC..1604..
	C5-CFOR-35080-04L500200-JET	02718638	C5	200,0 7.874	500,0 19.685	50,0 1.969	35,0 1.378	80 3.150	24,0 0.945	70,0 1015.3	0,8 1.760	4,0 0.157	5,0 44.3	LC..1604..
MDT	C5-CFOL-35080-04R080055-JET	02718609	C5	55,0 2.165	80,0 3.150	50,0 1.969	35,0 1.378	80 3.150	24,0 0.945	70,0 1015.3	0,8 1.760	4,0 0.157	5,0 44.3	LC..1604..
	C5-CFOL-35080-04R100070-JET	02718610	C5	70,0 2.756	100,0 3.937	50,0 1.969	35,0 1.378	80 3.150	24,0 0.945	70,0 1015.3	0,7 1.540	4,0 0.157	5,0 44.3	LC..1604..
	C5-CFOL-35080-04R130090-JET	02718611	C5	90,0 3.543	130,0 5.118	50,0 1.969	35,0 1.378	80 3.150	24,0 0.945	70,0 1015.3	0,8 1.760	4,0 0.157	5,0 44.3	LC..1604..
Mini-Shaft™	C5-CFOL-35080-04R170110-JET	02718612	C5	110,0 4.331	170,0 6.693	50,0 1.969	35,0 1.378	80 3.150	24,0 0.945	70,0 1015.3	0,8 1.760	4,0 0.157	5,0 44.3	LC..1604..
	C5-CFOL-35080-04R230140-JET	02718613	C5	140,0 5.512	230,0 9.055	50,0 1.969	35,0 1.378	80 3.150	24,0 0.945	70,0 1015.3	0,8 1.760	4,0 0.157	5,0 44.3	LC..1604..
	C5-CFOL-35080-04R500200-JET	02718614	C5	200,0 7.874	500,0 19.685	50,0 1.969	35,0 1.378	80 3.150	24,0 0.945	70,0 1015.3	0,8 1.760	4,0 0.157	5,0 44.3	LC..1604..
Grooving	C5-CFOR-35085-05L080055-JET	02718639	C5	55,0 2.165	80,0 3.150	50,0 1.969	35,0 1.378	85 3.346	30,0 1.181	70,0 1015.3	0,8 1.760	5,0 0.197	5,0 44.3	LC..1605..
	C5-CFOR-35085-05L100070-JET	02718640	C5	70,0 2.756	100,0 3.937	50,0 1.969	35,0 1.378	85 3.346	30,0 1.181	70,0 1015.3	0,8 1.760	5,0 0.197	5,0 44.3	LC..1605..
	C5-CFOR-35085-05L130090-JET	02718641	C5	90,0 3.543	130,0 5.118	50,0 1.969	35,0 1.378	85 3.346	30,0 1.181	70,0 1015.3	0,8 1.760	5,0 0.197	5,0 44.3	LC..1605..
Parting-off	C5-CFOR-35085-05L170110-JET	02718642	C5	110,0 4.331	170,0 6.693	50,0 1.969	35,0 1.378	85 3.346	30,0 1.181	70,0 1015.3	0,8 1.760	5,0 0.197	5,0 44.3	LC..1605..
	C5-CFOR-35085-05L230140-JET	02718643	C5	140,0 5.512	230,0 9.055	50,0 1.969	35,0 1.378	85 3.346	30,0 1.181	70,0 1015.3	0,8 1.760	5,0 0.197	5,0 44.3	LC..1605..
	C5-CFOR-35085-05L500200-JET	02718644	C5	200,0 7.874	500,0 19.685	50,0 1.969	35,0 1.378	85 3.346	30,0 1.181	70,0 1015.3	0,8 1.760	5,0 0.197	5,0 44.3	LC..1605..
X4	C5-CFOL-35085-05R080055-JET	02718615	C5	55,0 2.165	80,0 3.150	50,0 1.969	35,0 1.378	85 3.346	30,0 1.181	70,0 1015.3	0,8 1.760	5,0 0.197	5,0 44.3	LC..1605..
	C5-CFOL-35085-05R100070-JET	02718616	C5	70,0 2.756	100,0 3.937	50,0 1.969	35,0 1.378	85 3.346	30,0 1.181	70,0 1015.3	0,8 1.760	5,0 0.197	5,0 44.3	LC..1605..
	C5-CFOL-35085-05R130090-JET	02718617	C5	90,0 3.543	130,0 5.118	50,0 1.969	35,0 1.378	85 3.346	30,0 1.181	70,0 1015.3	0,7 1.540	5,0 0.197	5,0 44.3	LC..1605..
Adapters Clamping units	C5-CFOL-35085-05R170110-JET	02718618	C5	110,0 4.331	170,0 6.693	50,0 1.969	35,0 1.378	85 3.346	30,0 1.181	70,0 1015.3	0,8 1.760	5,0 0.197	5,0 44.3	LC..1605..
	C5-CFOL-35085-05R230140-JET	02718619	C5	140,0 5.512	230,0 9.055	50,0 1.969	35,0 1.378	85 3.346	30,0 1.181	70,0 1015.3	0,8 1.760	5,0 0.197	5,0 44.3	LC..1605..
	C5-CFOL-35085-05R500200-JET	02718620	C5	200,0 7.874	500,0 19.685	50,0 1.969	35,0 1.378	85 3.346	30,0 1.181	70,0 1015.3	0,8 1.760	5,0 0.197	5,0 44.3	LC..1605..
Accessories and Spare parts	C5-CFOR-35100-06L080055-JET	02718645	C5	55,0 2.165	80,0 3.150	50,0 1.969	35,0 1.378	100 3.937	36,0 1.417	70,0 1015.3	0,9 1.980	6,0 0.236	5,0 44.3	LC..1606..
	C5-CFOR-35100-06L100070-JET	02718646	C5	70,0 2.756	100,0 3.937	50,0 1.969	35,0 1.378	100 3.937	36,0 1.417	70,0 1015.3	1,0 2.200	6,0 0.236	5,0 44.3	LC..1606..
	C5-CFOR-35100-06L130090-JET	02718647	C5	90,0 3.543	130,0 5.118	50,0 1.969	35,0 1.378	100 3.937	36,0 1.417	70,0 1015.3	1,0 2.200	6,0 0.236	5,0 44.3	LC..1606..
Workpiece materials	C5-CFOR-35100-06L170110-JET	02718648	C5	110,0 4.331	170,0 6.693	50,0 1.969	35,0 1.378	100 3.937	36,0 1.417	70,0 1015.3	1,0 2.200	6,0 0.236	5,0 44.3	LC..1606..
	C5-CFOR-35100-06L230140-JET	02718649	C5	140,0 5.512	230,0 9.055	50,0 1.969	35,0 1.378	100 3.937	36,0 1.417	70,0 1015.3	1,0 2.200	6,0 0.236	5,0 44.3	LC..1606..
	C5-CFOR-35100-06L500200-JET	02718650	C5	200,0 7.874	500,0 19.685	50,0 1.969	35,0 1.378	100 3.937	36,0 1.417	70,0 1015.3	1,0 2.200	6,0 0.236	5,0 44.3	LC..1606..
	C5-CFOL-35100-06R080055-JET	02718621	C5	55,0 2.165	80,0 3.150	50,0 1.969	35,0 1.378	100 3.937	36,0 1.417	70,0 1015.3	0,9 1.980	6,0 0.236	5,0 44.3	LC..1606..

Designation	Item number	CTMS	INPLM	INPLX	DCSFM5	WF	LF	CDX**	CP***	Weight	CW	TQ	CTWS
			mm Inch	mm Inch	mm Inch	mm Inch	mm Inch	mm Inch	mm Inch				
C5-CFOL-35100-06R100070-JET	02718622	C5	70,0 2.756	100,0 3.937	50,0 1.969	35,0 1.378	100 3.937	36,0 1.417	70,0 1015.3	1,0 2.200	6,0 0.236	5,0 44.3	LC..1606..
C5-CFOL-35100-06R130090-JET	02718623	C5	90,0 3.543	130,0 5.118	50,0 1.969	35,0 1.378	100 3.937	36,0 1.417	70,0 1015.3	1,0 2.200	6,0 0.236	5,0 44.3	LC..1606..
C5-CFOL-35100-06R170110-JET	02718624	C5	110,0 4.331	170,0 6.693	50,0 1.969	35,0 1.378	100 3.937	36,0 1.417	70,0 1015.3	1,0 2.200	6,0 0.236	5,0 44.3	LC..1606..
C5-CFOL-35100-06R230140-JET	02718625	C5	140,0 5.512	230,0 9.055	50,0 1.969	35,0 1.378	100 3.937	36,0 1.417	70,0 1015.3	1,0 2.200	6,0 0.236	5,0 44.3	LC..1606..
C5-CFOL-35100-06R500200-JET	02718626	C5	200,0 7.874	500,0 19.685	50,0 1.969	35,0 1.378	100 3.937	36,0 1.417	70,0 1015.3	1,0 2.200	6,0 0.236	5,0 44.3	LC..1606..
C6-CFOR-45075-03L080055-JET	02718679	C6	55,0 2.165	80,0 3.150	63,0 2.480	45,0 1.772	75 2.953	18,0 0.709	70,0 1015.3	1,2 2.650	3,0 0.118	5,0 44.3	LC..1603..
C6-CFOR-45075-03L100070-JET	02718680	C6	70,0 2.756	100,0 3.937	63,0 2.480	45,0 1.772	75 2.953	18,0 0.709	70,0 1015.3	1,1 2.430	3,0 0.118	5,0 44.3	LC..1603..
C6-CFOR-45075-03L130090-JET	02718681	C6	90,0 3.543	130,0 5.118	63,0 2.480	45,0 1.772	75 2.953	18,0 0.709	70,0 1015.3	1,2 2.650	3,0 0.118	5,0 44.3	LC..1603..
C6-CFOR-45075-03L170110-JET	02718682	C6	110,0 4.331	170,0 6.693	63,0 2.480	45,0 1.772	75 2.953	18,0 0.709	70,0 1015.3	1,1 2.430	3,0 0.118	5,0 44.3	LC..1603..
C6-CFOR-45075-03L230140-JET	02718683	C6	140,0 5.512	230,0 9.055	63,0 2.480	45,0 1.772	75 2.953	18,0 0.709	70,0 1015.3	1,2 2.650	3,0 0.118	5,0 44.3	LC..1603..
C6-CFOR-45075-03L500200-JET	02718684	C6	200,0 7.874	500,0 19.685	63,0 2.480	45,0 1.772	75 2.953	18,0 0.709	70,0 1015.3	1,2 2.650	3,0 0.118	5,0 44.3	LC..1603..
C6-CFOL-45075-03R080055-JET	02718651	C6	55,0 2.165	80,0 3.150	63,0 2.480	45,0 1.772	75 2.953	18,0 0.709	70,0 1015.3	1,2 2.650	3,0 0.118	5,0 44.3	LC..1603..
C6-CFOL-45075-03R100070-JET	02718652	C6	70,0 2.756	100,0 3.937	63,0 2.480	45,0 1.772	75 2.953	18,0 0.709	70,0 1015.3	1,1 2.430	3,0 0.118	5,0 44.3	LC..1603..
C6-CFOL-45075-03R130090-JET	02718653	C6	90,0 3.543	130,0 5.118	63,0 2.480	45,0 1.772	75 2.953	18,0 0.709	70,0 1015.3	1,2 2.650	3,0 0.118	5,0 44.3	LC..1603..
C6-CFOL-45075-03R170110-JET	02718654	C6	110,0 4.331	170,0 6.693	63,0 2.480	45,0 1.772	75 2.953	18,0 0.709	70,0 1015.3	1,1 2.430	3,0 0.118	5,0 44.3	LC..1603..
C6-CFOL-45075-03R230140-JET	02718655	C6	140,0 5.512	230,0 9.055	63,0 2.480	45,0 1.772	75 2.953	18,0 0.709	70,0 1015.3	1,2 2.650	3,0 0.118	5,0 44.3	LC..1603..
C6-CFOL-45075-03R500200-JET	02718656	C6	200,0 7.874	500,0 19.685	63,0 2.480	45,0 1.772	75 2.953	18,0 0.709	70,0 1015.3	1,2 2.650	3,0 0.118	5,0 44.3	LC..1603..
C6-CFOR-45080-04L080055-JET	02718685	C6	55,0 2.165	80,0 3.150	63,0 2.480	45,0 1.772	80 3.150	24,0 0.945	70,0 1015.3	1,2 2.650	4,0 0.157	5,0 44.3	LC..1604..
C6-CFOR-45080-04L100070-JET	02718686	C6	70,0 2.756	100,0 3.937	63,0 2.480	45,0 1.772	80 3.150	24,0 0.945	70,0 1015.3	1,2 2.650	4,0 0.157	5,0 44.3	LC..1604..
C6-CFOR-45080-04L130090-JET	02718687	C6	90,0 3.543	130,0 5.118	63,0 2.480	45,0 1.772	80 3.150	24,0 0.945	70,0 1015.3	1,2 2.650	4,0 0.157	5,0 44.3	LC..1604..
C6-CFOR-45080-04L170110-JET	02718688	C6	110,0 4.331	170,0 6.693	63,0 2.480	45,0 1.772	80 3.150	24,0 0.945	70,0 1015.3	1,2 2.650	4,0 0.157	5,0 44.3	LC..1604..
C6-CFOR-45080-04L230140-JET	02718689	C6	140,0 5.512	230,0 9.055	63,0 2.480	45,0 1.772	80 3.150	24,0 0.945	70,0 1015.3	1,2 2.650	4,0 0.157	5,0 44.3	LC..1604..
C6-CFOR-45080-04L500200-JET	02718690	C6	200,0 7.874	500,0 19.685	63,0 2.480	45,0 1.772	80 3.150	24,0 0.945	70,0 1015.3	1,2 2.650	4,0 0.157	5,0 44.3	LC..1604..
C6-CFOL-45080-04R080055-JET	02718657	C6	55,0 2.165	80,0 3.150	63,0 2.480	45,0 1.772	80 3.150	24,0 0.945	70,0 1015.3	1,2 2.650	4,0 0.157	5,0 44.3	LC..1604..
C6-CFOL-45080-04R100070-JET	02718658	C6	70,0 2.756	100,0 3.937	63,0 2.480	45,0 1.772	80 3.150	24,0 0.945	70,0 1015.3	1,2 2.650	4,0 0.157	5,0 44.3	LC..1604..
C6-CFOL-45080-04R130090-JET	02718659	C6	90,0 3.543	130,0 5.118	63,0 2.480	45,0 1.772	80 3.150	24,0 0.945	70,0 1015.3	1,2 2.650	4,0 0.157	5,0 44.3	LC..1604..
C6-CFOL-45080-04R170110-JET	02718660	C6	110,0 4.331	170,0 6.693	63,0 2.480	45,0 1.772	80 3.150	24,0 0.945	70,0 1015.3	1,2 2.650	4,0 0.157	5,0 44.3	LC..1604..
C6-CFOL-45080-04R230140-JET	02718661	C6	140,0 5.512	230,0 9.055	63,0 2.480	45,0 1.772	80 3.150	24,0 0.945	70,0 1015.3	1,2 2.650	4,0 0.157	5,0 44.3	LC..1604..
C6-CFOL-45080-04R500200-JET	02718662	C6	200,0 7.874	500,0 19.685	63,0 2.480	45,0 1.772	80 3.150	24,0 0.945	70,0 1015.3	1,2 2.650	4,0 0.157	5,0 44.3	LC..1604..
C6-CFOR-45090-05L080055-JET	02718691	C6	55,0 2.165	80,0 3.150	63,0 2.480	45,0 1.772	90 3.543	30,0 1.181	70,0 1015.3	1,2 2.650	5,0 0.197	5,0 44.3	LC..1605..
C6-CFOR-45090-05L100070-JET	02718692	C6	70,0 2.756	100,0 3.937	63,0 2.480	45,0 1.772	90 3.543	30,0 1.181	70,0 1015.3	1,2 2.650	5,0 0.197	5,0 44.3	LC..1605..

General ISO Turning
Steadyline®
MDT
Mini-Shaft™
Grooving
Parting-off
X4
Adapters
Clamping units
Accessories and Spare parts
Workpiece materials



MDT – Multi Directional Turning

Toolholders, external axial, Jetstream Tooling®, Seco-Capto™



	Designation	Item number	CTMS	INPLM	INPLX	DCSFMS	WF	LF	CDX**	CP***	Weight	CW	TQ	CTWS
				mm Inch	mm Inch	mm Inch	mm Inch	mm Inch	mm Inch	mm Inch	mm Inch	bar psi	kg lbs	mm Inch
General ISO Turning	C6-CFOR-45090-05L130090-JET	02718693	C6	90,0 3.543	130,0 5.118	63,0 2.480	45,0 1.772	90 3.543	30,0 1.181	70,0 1015.3	1,2 2.650	5,0 0.197	5,0 44.3	LC..1605..
	C6-CFOR-45090-05L170110-JET	02718694	C6	110,0 4.331	170,0 6.693	63,0 2.480	45,0 1.772	90 3.543	30,0 1.181	70,0 1015.3	1,2 2.650	5,0 0.197	5,0 44.3	LC..1605..
	C6-CFOR-45090-05L230140-JET	02718695	C6	140,0 5.512	230,0 9.055	63,0 2.480	45,0 1.772	90 3.543	30,0 1.181	70,0 1015.3	1,2 2.650	5,0 0.197	5,0 44.3	LC..1605..
Steadyline®	C6-CFOR-45090-05L500200-JET	02718696	C6	200,0 7.874	500,0 19.685	63,0 2.480	45,0 1.772	90 3.543	30,0 1.181	70,0 1015.3	1,2 2.650	5,0 0.197	5,0 44.3	LC..1605..
	C6-CFOL-45090-05R080055-JET	02718663	C6	55,0 2.165	80,0 3.150	63,0 2.480	45,0 1.772	90 3.543	30,0 1.181	70,0 1015.3	1,2 2.650	5,0 0.197	5,0 44.3	LC..1605..
	C6-CFOL-45090-05R100070-JET	02718664	C6	70,0 2.756	100,0 3.937	63,0 2.480	45,0 1.772	90 3.543	30,0 1.181	70,0 1015.3	1,2 2.650	5,0 0.197	5,0 44.3	LC..1605..
MDT	C6-CFOL-45090-05R130090-JET	02718665	C6	90,0 3.543	130,0 5.118	63,0 2.480	45,0 1.772	90 3.543	30,0 1.181	70,0 1015.3	1,2 2.650	5,0 0.197	5,0 44.3	LC..1605..
	C6-CFOL-45090-05R170110-JET	02718666	C6	110,0 4.331	170,0 6.693	63,0 2.480	45,0 1.772	90 3.543	30,0 1.181	70,0 1015.3	1,2 2.650	5,0 0.197	5,0 44.3	LC..1605..
	C6-CFOL-45090-05R230140-JET	02718667	C6	140,0 5.512	230,0 9.055	63,0 2.480	45,0 1.772	90 3.543	30,0 1.181	70,0 1015.3	1,2 2.650	5,0 0.197	5,0 44.3	LC..1605..
Mini-Shaft™	C6-CFOL-45090-05R500200-JET	02718668	C6	200,0 7.874	500,0 19.685	63,0 2.480	45,0 1.772	90 3.543	30,0 1.181	70,0 1015.3	1,2 2.650	5,0 0.197	5,0 44.3	LC..1605..
	C6-CFOR-45100-06L080055-JET	02718697	C6	55,0 2.165	80,0 3.150	63,0 2.480	45,0 1.772	100 3.937	36,0 1.417	70,0 1015.3	1,4 3.090	6,0 0.236	5,0 44.3	LC..1606..
	C6-CFOR-45100-06L100070-JET	02718698	C6	70,0 2.756	100,0 3.937	63,0 2.480	45,0 1.772	100 3.937	36,0 1.417	70,0 1015.3	1,4 3.090	6,0 0.236	5,0 44.3	LC..1606..
Grooving	C6-CFOR-45100-06L130090-JET	02718699	C6	90,0 3.543	130,0 5.118	63,0 2.480	45,0 1.772	100 3.937	36,0 1.417	70,0 1015.3	1,3 2.870	6,0 0.236	5,0 44.3	LC..1606..
	C6-CFOR-45100-06L170110-JET	02718700	C6	110,0 4.331	170,0 6.693	63,0 2.480	45,0 1.772	100 3.937	36,0 1.417	70,0 1015.3	1,3 2.870	6,0 0.236	5,0 44.3	LC..1606..
	C6-CFOR-45100-06L230140-JET	02718701	C6	140,0 5.512	230,0 9.055	63,0 2.480	45,0 1.772	100 3.937	36,0 1.417	70,0 1015.3	1,3 2.870	6,0 0.236	5,0 44.3	LC..1606..
Parting-off	C6-CFOR-45100-06L500200-JET	02718702	C6	200,0 7.874	500,0 19.685	63,0 2.480	45,0 1.772	100 3.937	36,0 1.417	70,0 1015.3	1,3 2.870	6,0 0.236	5,0 44.3	LC..1606..
	C6-CFOL-45100-06R080055-JET	02718669	C6	55,0 2.165	80,0 3.150	63,0 2.480	45,0 1.772	100 3.937	36,0 1.417	70,0 1015.3	1,4 3.090	6,0 0.236	5,0 44.3	LC..1606..
	C6-CFOL-45100-06R100070-JET	02718670	C6	70,0 2.756	100,0 3.937	63,0 2.480	45,0 1.772	100 3.937	36,0 1.417	70,0 1015.3	1,4 3.090	6,0 0.236	5,0 44.3	LC..1606..
X4	C6-CFOL-45100-06R130090-JET	02718671	C6	90,0 3.543	130,0 5.118	63,0 2.480	45,0 1.772	100 3.937	36,0 1.417	70,0 1015.3	1,3 2.870	6,0 0.236	5,0 44.3	LC..1606..
	C6-CFOL-45100-06R170110-JET	02718672	C6	110,0 4.331	170,0 6.693	63,0 2.480	45,0 1.772	100 3.937	36,0 1.417	70,0 1015.3	1,3 2.870	6,0 0.236	5,0 44.3	LC..1606..
	C6-CFOL-45100-06R230140-JET	02718673	C6	140,0 5.512	230,0 9.055	63,0 2.480	45,0 1.772	100 3.937	36,0 1.417	70,0 1015.3	1,3 2.870	6,0 0.236	5,0 44.3	LC..1606..
Adapters Clamping units	C6-CFOR-45100-06R500200-JET	02718674	C6	200,0 7.874	500,0 19.685	63,0 2.480	45,0 1.772	100 3.937	36,0 1.417	70,0 1015.3	1,3 2.870	6,0 0.236	5,0 44.3	LC..1606..
	C6-CFOR-45115-08L130090-JET	02718703	C6	90,0 3.543	130,0 5.118	63,0 2.480	45,0 1.772	115 4.528	48,0 1.890	70,0 1015.3	1,5 3.310	8,0 0.315	10,0 88.5	LC..3008..
	C6-CFOR-45115-08L170110-JET	02718704	C6	110,0 4.331	170,0 6.693	63,0 2.480	45,0 1.772	115 4.528	48,0 1.890	70,0 1015.3	1,5 3.310	8,0 0.315	10,0 88.5	LC..3008..
Accessories and Spare parts	C6-CFOR-45115-08L230140-JET	02718705	C6	140,0 5.512	230,0 9.055	63,0 2.480	45,0 1.772	115 4.528	48,0 1.890	70,0 1015.3	1,4 3.090	8,0 0.315	10,0 88.5	LC..3008..
	C6-CFOR-45115-08L500200-JET	02718706	C6	200,0 7.874	500,0 19.685	63,0 2.480	45,0 1.772	115 4.528	48,0 1.890	70,0 1015.3	1,4 3.090	8,0 0.315	10,0 88.5	LC..3008..
	C6-CFOL-45115-08R130090-JET	02718675	C6	90,0 3.543	130,0 5.118	63,0 2.480	45,0 1.772	115 4.528	48,0 1.890	70,0 1015.3	1,5 3.310	8,0 0.315	10,0 88.5	LC..3008..
Workpiece materials	C6-CFOL-45115-08R170110-JET	02718676	C6	110,0 4.331	170,0 6.693	63,0 2.480	45,0 1.772	115 4.528	48,0 1.890	70,0 1015.3	1,5 3.310	8,0 0.315	10,0 88.5	LC..3008..
	C6-CFOR-45115-08R230140-JET	02718677	C6	140,0 5.512	230,0 9.055	63,0 2.480	45,0 1.772	115 4.528	48,0 1.890	70,0 1015.3	1,4 3.090	8,0 0.315	10,0 88.5	LC..3008..
	C6-CFOR-45115-08R500200-JET	02718678	C6	200,0 7.874	500,0 19.685	63,0 2.480	45,0 1.772	115 4.528	48,0 1.890	70,0 1015.3	1,4 3.090	8,0 0.315	10,0 88.5	LC..3008..

Spare Parts

For size	Clamp key	Clamp screw
		
CFOR/L...03	4SMS795	TCEI0513
CFOR/L...04	5SMS795	TCEI0613
CFOR/L...05	5SMS795	TCEI0613
CFOR/L...06	6SMS795	TCEI0815
CFOR/L...08	6SMS795	TCEI1020

- General / ISO Turning
- Steadyline®
- MDT**
- Mini-Shaft™
- Grooving
- Parting-off
- X4
- Adapters
Clamping units
- Accessories and
Spare parts
- Workpiece
materials

General ISO Turning

Steadyline®

MDT

Mini-Shaft™

Grooving

Parting-off

X4

Adapters
Clamping units

Accessories and
Spare parts

Workpiece
materials

C-CFOR...R...JET, C-CFOL...L...JET – Toolholders for inserts LCGF, LCGN, LCMF and LCMR – Metric/ Inch

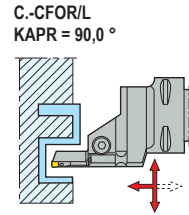
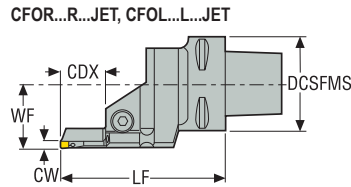

CTWS



- For inserts program, see page(s) 839-844, 854-855
- For more information on Jetstream Tooling® (High pressure coolant) and accessories, please see page(s) 38, 85-89, 1002
- Initial plunge (INPLM/INPLX) relates to face groove diameter, see page(s) 705
- CTMS = Seco-Capto™ size
- CTWS = Insert shape and size
- ** Max depth of cut for double-sided LCGF/LCMF16.. = 14 mm / 0.551 inch, LCGF/LCMF30.. = 28 mm / 1.102 inch
- *** Max coolant pressure
- CDX = 6 x CW
- Right-hand version with right-hand blade shown
- Please check availability at www.secotools.com / Seco Online Store

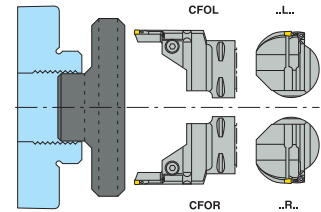

Designation	Item number	CTMS	INPLM		INPLX		DCSFMS	WF	LF	CDX**	CP***	Weight	CW	TQ	CTWS								
			mm	Inch	mm	Inch										mm	Inch	bar	kg	mm	Nm		
C4-CFOR-27070-03R080055-JET	02718725	C4	55,0	2.165	80,0	3.150	40,0	1.575	27,0	1.063	70	2.756	0,709	18,0	70,0	1015.3	0,5	1.100	3,0	0.118	5,0	44.3	LC..1603..
C4-CFOR-27070-03R100070-JET	02718726	C4	70,0	2.756	100,0	3.937	40,0	1.575	27,0	1.063	70	2.756	0,709	18,0	70,0	1015.3	0,5	1.100	3,0	0.118	5,0	44.3	LC..1603..
C4-CFOR-27070-03R130090-JET	02718727	C4	90,0	3.543	130,0	5.118	40,0	1.575	27,0	1.063	70	2.756	0,709	18,0	70,0	1015.3	0,5	1.100	3,0	0.118	5,0	44.3	LC..1603..
C4-CFOR-27070-03R170110-JET	02718728	C4	110,0	4.331	170,0	6.693	40,0	1.575	27,0	1.063	70	2.756	0,709	18,0	70,0	1015.3	0,5	1.100	3,0	0.118	5,0	44.3	LC..1603..
C4-CFOR-27070-03R230140-JET	02718729	C4	140,0	5.512	230,0	9.055	40,0	1.575	27,0	1.063	70	2.756	0,709	18,0	70,0	1015.3	0,5	1.100	3,0	0.118	5,0	44.3	LC..1603..
C4-CFOR-27070-03R500200-JET	02718730	C4	200,0	7.874	500,0	19.685	40,0	1.575	27,0	1.063	70	2.756	0,709	18,0	70,0	1015.3	0,5	1.100	3,0	0.118	5,0	44.3	LC..1603..
C4-CFOL-27070-03L080055-JET	02718707	C4	55,0	2.165	80,0	3.150	40,0	1.575	27,0	1.063	70	2.756	0,709	18,0	70,0	1015.3	0,5	1.100	3,0	0.118	5,0	44.3	LC..1603..
C4-CFOL-27070-03L100070-JET	02718708	C4	70,0	2.756	100,0	3.937	40,0	1.575	27,0	1.063	70	2.756	0,709	18,0	70,0	1015.3	0,5	1.100	3,0	0.118	5,0	44.3	LC..1603..
C4-CFOL-27070-03L130090-JET	02718709	C4	90,0	3.543	130,0	5.118	40,0	1.575	27,0	1.063	70	2.756	0,709	18,0	70,0	1015.3	0,5	1.100	3,0	0.118	5,0	44.3	LC..1603..
C4-CFOL-27070-03L170110-JET	02718710	C4	110,0	4.331	170,0	6.693	40,0	1.575	27,0	1.063	70	2.756	0,709	18,0	70,0	1015.3	0,5	1.100	3,0	0.118	5,0	44.3	LC..1603..
C4-CFOL-27070-03L230140-JET	02718711	C4	140,0	5.512	230,0	9.055	40,0	1.575	27,0	1.063	70	2.756	0,709	18,0	70,0	1015.3	0,5	1.100	3,0	0.118	5,0	44.3	LC..1603..
C4-CFOL-27070-03L500200-JET	02718712	C4	200,0	7.874	500,0	19.685	40,0	1.575	27,0	1.063	70	2.756	0,709	18,0	70,0	1015.3	0,5	1.100	3,0	0.118	5,0	44.3	LC..1603..
C4-CFOR-27080-04R080055-JET	02718731	C4	55,0	2.165	80,0	3.150	40,0	1.575	27,0	1.063	80	3.150	0,945	24,0	70,0	1015.3	0,5	1.100	4,0	0.157	5,0	44.3	LC..1604..
C4-CFOR-27080-04R100070-JET	02718732	C4	70,0	2.756	100,0	3.937	40,0	1.575	27,0	1.063	80	3.150	0,945	24,0	70,0	1015.3	0,5	1.100	4,0	0.157	5,0	44.3	LC..1604..
C4-CFOR-27080-04R130090-JET	02718733	C4	90,0	3.543	130,0	5.118	40,0	1.575	27,0	1.063	80	3.150	0,945	24,0	70,0	1015.3	0,5	1.100	4,0	0.157	5,0	44.3	LC..1604..
C4-CFOR-27080-04R170110-JET	02718734	C4	110,0	4.331	170,0	6.693	40,0	1.575	27,0	1.063	80	3.150	0,945	24,0	70,0	1015.3	0,5	1.100	4,0	0.157	5,0	44.3	LC..1604..
C4-CFOR-27080-04R230140-JET	02718735	C4	140,0	5.512	230,0	9.055	40,0	1.575	27,0	1.063	80	3.150	0,945	24,0	70,0	1015.3	0,5	1.100	4,0	0.157	5,0	44.3	LC..1604..

Designation	Item number	CTMS	INPLM	INPLX	DCSFM5	WF	LF	CDX**	CP***	Weight	CW	TQ	CTWS
			mm Inch	mm Inch	mm Inch	mm Inch	mm Inch	mm Inch	mm Inch				
C4-CFOR-27080-04R500200-JET	02718736	C4	200,0 7.874	500,0 19.685	40,0 1.575	27,0 1.063	80 3.150	24,0 0.945	70,0 1015.3	0,5 1.100	4,0 0.157	5,0 44.3	LC..1604..
C4-CFOL-27080-04L080055-JET	02718713	C4	55,0 2.165	80,0 3.150	40,0 1.575	27,0 1.063	80 3.150	24,0 0.945	70,0 1015.3	0,5 1.100	4,0 0.157	5,0 44.3	LC..1604..
C4-CFOL-27080-04L100070-JET	02718714	C4	70,0 2.756	100,0 3.937	40,0 1.575	27,0 1.063	80 3.150	24,0 0.945	70,0 1015.3	0,5 1.100	4,0 0.157	5,0 44.3	LC..1604..
C4-CFOL-27080-04L130090-JET	02718715	C4	90,0 3.543	130,0 5.118	40,0 1.575	27,0 1.063	80 3.150	24,0 0.945	70,0 1015.3	0,5 1.100	4,0 0.157	5,0 44.3	LC..1604..
C4-CFOL-27080-04L170110-JET	02718716	C4	110,0 4.331	170,0 6.693	40,0 1.575	27,0 1.063	80 3.150	24,0 0.945	70,0 1015.3	0,5 1.100	4,0 0.157	5,0 44.3	LC..1604..
C4-CFOL-27080-04L230140-JET	02718717	C4	140,0 5.512	230,0 9.055	40,0 1.575	27,0 1.063	80 3.150	24,0 0.945	70,0 1015.3	0,5 1.100	4,0 0.157	5,0 44.3	LC..1604..
C4-CFOL-27080-04L500200-JET	02718718	C4	200,0 7.874	500,0 19.685	40,0 1.575	27,0 1.063	80 3.150	24,0 0.945	70,0 1015.3	0,5 1.100	4,0 0.157	5,0 44.3	LC..1604..
C4-CFOR-27085-05R080055-JET	02718737	C4	55,0 2.165	80,0 3.150	40,0 1.575	27,0 1.063	85 3.346	30,0 1.181	70,0 1015.3	0,5 1.100	5,0 0.197	5,0 44.3	LC..1605..
C4-CFOR-27085-05R100070-JET	02718738	C4	70,0 2.756	100,0 3.937	40,0 1.575	27,0 1.063	85 3.346	30,0 1.181	70,0 1015.3	0,5 1.100	5,0 0.197	5,0 44.3	LC..1605..
C4-CFOR-27085-05R130090-JET	02718739	C4	90,0 3.543	130,0 5.118	40,0 1.575	27,0 1.063	85 3.346	30,0 1.181	70,0 1015.3	0,5 1.100	5,0 0.197	5,0 44.3	LC..1605..
C4-CFOR-27085-05R170110-JET	02718740	C4	110,0 4.331	170,0 6.693	40,0 1.575	27,0 1.063	85 3.346	30,0 1.181	70,0 1015.3	0,5 1.100	5,0 0.197	5,0 44.3	LC..1605..
C4-CFOR-27085-05R230140-JET	02718741	C4	140,0 5.512	230,0 9.055	40,0 1.575	27,0 1.063	85 3.346	30,0 1.181	70,0 1015.3	0,5 1.100	5,0 0.197	5,0 44.3	LC..1605..
C4-CFOR-27085-05R500200-JET	02718742	C4	200,0 7.874	500,0 19.685	40,0 1.575	27,0 1.063	85 3.346	30,0 1.181	70,0 1015.3	0,5 1.100	5,0 0.197	5,0 44.3	LC..1605..
C4-CFOL-27085-05L080055-JET	02718719	C4	55,0 2.165	80,0 3.150	40,0 1.575	27,0 1.063	85 3.346	30,0 1.181	70,0 1015.3	0,5 1.100	5,0 0.197	5,0 44.3	LC..1605..
C4-CFOL-27085-05L100070-JET	02718720	C4	70,0 2.756	100,0 3.937	40,0 1.575	27,0 1.063	85 3.346	30,0 1.181	70,0 1015.3	0,5 1.100	5,0 0.197	5,0 44.3	LC..1605..
C4-CFOL-27085-05L130090-JET	02718721	C4	90,0 3.543	130,0 5.118	40,0 1.575	27,0 1.063	85 3.346	30,0 1.181	70,0 1015.3	0,5 1.100	5,0 0.197	5,0 44.3	LC..1605..
C4-CFOL-27085-05L170110-JET	02718722	C4	110,0 4.331	170,0 6.693	40,0 1.575	27,0 1.063	85 3.346	30,0 1.181	70,0 1015.3	0,5 1.100	5,0 0.197	5,0 44.3	LC..1605..
C4-CFOL-27085-05L230140-JET	02718723	C4	140,0 5.512	230,0 9.055	40,0 1.575	27,0 1.063	85 3.346	30,0 1.181	70,0 1015.3	0,5 1.100	5,0 0.197	5,0 44.3	LC..1605..
C4-CFOL-27085-05L500200-JET	02718724	C4	200,0 7.874	500,0 19.685	40,0 1.575	27,0 1.063	85 3.346	30,0 1.181	70,0 1015.3	0,5 1.100	5,0 0.197	5,0 44.3	LC..1605..
C5-CFOR-35070-03R080055-JET	02718767	C5	55,0 2.165	80,0 3.150	50,0 1.969	35,0 1.378	70 2.756	18,0 0.709	70,0 1015.3	0,7 1.540	3,0 0.118	5,0 44.3	LC..1603..
C5-CFOR-35070-03R100070-JET	02718768	C5	70,0 2.756	100,0 3.937	50,0 1.969	35,0 1.378	70 2.756	18,0 0.709	70,0 1015.3	0,7 1.540	3,0 0.118	5,0 44.3	LC..1603..
C5-CFOR-35070-03R130090-JET	02718769	C5	90,0 3.543	130,0 5.118	50,0 1.969	35,0 1.378	70 2.756	18,0 0.709	70,0 1015.3	0,7 1.540	3,0 0.118	5,0 44.3	LC..1603..
C5-CFOR-35070-03R170110-JET	02718770	C5	110,0 4.331	170,0 6.693	50,0 1.969	35,0 1.378	70 2.756	18,0 0.709	70,0 1015.3	0,7 1.540	3,0 0.118	5,0 44.3	LC..1603..
C5-CFOR-35070-03R230140-JET	02718771	C5	140,0 5.512	230,0 9.055	50,0 1.969	35,0 1.378	70 2.756	18,0 0.709	70,0 1015.3	0,7 1.540	3,0 0.118	5,0 44.3	LC..1603..
C5-CFOR-35070-03R500200-JET	02718772	C5	200,0 7.874	500,0 19.685	50,0 1.969	35,0 1.378	70 2.756	18,0 0.709	70,0 1015.3	0,7 1.540	3,0 0.118	5,0 44.3	LC..1603..
C5-CFOL-35070-03L080055-JET	02718743	C5	55,0 2.165	80,0 3.150	50,0 1.969	35,0 1.378	70 2.756	18,0 0.709	70,0 1015.3	0,7 1.540	3,0 0.118	5,0 44.3	LC..1603..
C5-CFOL-35070-03L100070-JET	02718744	C5	70,0 2.756	100,0 3.937	50,0 1.969	35,0 1.378	70 2.756	18,0 0.709	70,0 1015.3	0,7 1.540	3,0 0.118	5,0 44.3	LC..1603..
C5-CFOL-35070-03L130090-JET	02718745	C5	90,0 3.543	130,0 5.118	50,0 1.969	35,0 1.378	70 2.756	18,0 0.709	70,0 1015.3	0,7 1.540	3,0 0.118	5,0 44.3	LC..1603..
C5-CFOL-35070-03L170110-JET	02718746	C5	110,0 4.331	170,0 6.693	50,0 1.969	35,0 1.378	70 2.756	18,0 0.709	70,0 1015.3	0,7 1.540	3,0 0.118	5,0 44.3	LC..1603..
C5-CFOL-35070-03L230140-JET	02718747	C5	140,0 5.512	230,0 9.055	50,0 1.969	35,0 1.378	70 2.756	18,0 0.709	70,0 1015.3	0,7 1.540	3,0 0.118	5,0 44.3	LC..1603..
C5-CFOL-35070-03L500200-JET	02718748	C5	200,0 7.874	500,0 19.685	50,0 1.969	35,0 1.378	70 2.756	18,0 0.709	70,0 1015.3	0,7 1.540	3,0 0.118	5,0 44.3	LC..1603..

General ISO Turning
Steadyline®
MDT
Mini-Shaft™
Grooving
Parting-off
X4
Adapters
Clamping units
Accessories and Spare parts
Workpiece materials

MDT – Multi Directional Turning

Toolholders, external axial, Jetstream Tooling®, Seco-Capto™



	Designation	Item number	CTMS	INPLM	INPLX	DCSFMS	WF	LF	CDX**	CP***	Weight	CW	TQ	CTWS
				mm Inch	mm Inch	mm Inch	mm Inch	mm Inch	mm Inch	mm Inch	bar psi	kg lbs	mm Inch	Nm In/Lbs.
General ISO Turning	C5-CFOR-35080-04R080055-JET	02718773	C5	55,0 2.165	80,0 3.150	50,0 1.969	35,0 1.378	80 3.150	24,0 0.945	70,0 1015.3	0,7 1.540	4,0 0.157	5,0 44.3	LC..1604..
	C5-CFOR-35080-04R100070-JET	02718774	C5	70,0 2.756	100,0 3.937	50,0 1.969	35,0 1.378	80 3.150	24,0 0.945	70,0 1015.3	0,7 1.540	4,0 0.157	5,0 44.3	LC..1604..
	C5-CFOR-35080-04R130090-JET	02718775	C5	90,0 3.543	130,0 5.118	50,0 1.969	35,0 1.378	80 3.150	24,0 0.945	70,0 1015.3	0,7 1.540	4,0 0.157	5,0 44.3	LC..1604..
Steadyline®	C5-CFOR-35080-04R170110-JET	02718776	C5	110,0 4.331	170,0 6.693	50,0 1.969	35,0 1.378	80 3.150	24,0 0.945	70,0 1015.3	0,7 1.540	4,0 0.157	5,0 44.3	LC..1604..
	C5-CFOR-35080-04R230140-JET	02718777	C5	140,0 5.512	230,0 9.055	50,0 1.969	35,0 1.378	80 3.150	24,0 0.945	70,0 1015.3	0,7 1.540	4,0 0.157	5,0 44.3	LC..1604..
	C5-CFOR-35080-04R500200-JET	02718778	C5	200,0 7.874	500,0 19.685	50,0 1.969	35,0 1.378	80 3.150	24,0 0.945	70,0 1015.3	0,7 1.540	4,0 0.157	5,0 44.3	LC..1604..
MDT	C5-CFOL-35080-04L080055-JET	02718749	C5	55,0 2.165	80,0 3.150	50,0 1.969	35,0 1.378	80 3.150	24,0 0.945	70,0 1015.3	0,7 1.540	4,0 0.157	5,0 44.3	LC..1604..
	C5-CFOL-35080-04L100070-JET	02718750	C5	70,0 2.756	100,0 3.937	50,0 1.969	35,0 1.378	80 3.150	24,0 0.945	70,0 1015.3	0,7 1.540	4,0 0.157	5,0 44.3	LC..1604..
	C5-CFOL-35080-04L130090-JET	02718751	C5	90,0 3.543	130,0 5.118	50,0 1.969	35,0 1.378	80 3.150	24,0 0.945	70,0 1015.3	0,7 1.540	4,0 0.157	5,0 44.3	LC..1604..
Mini-Shaft™	C5-CFOL-35080-04L170110-JET	02718752	C5	110,0 4.331	170,0 6.693	50,0 1.969	35,0 1.378	80 3.150	24,0 0.945	70,0 1015.3	0,7 1.540	4,0 0.157	5,0 44.3	LC..1604..
	C5-CFOL-35080-04L230140-JET	02718753	C5	140,0 5.512	230,0 9.055	50,0 1.969	35,0 1.378	80 3.150	24,0 0.945	70,0 1015.3	0,7 1.540	4,0 0.157	5,0 44.3	LC..1604..
	C5-CFOL-35080-04L500200-JET	02718754	C5	200,0 7.874	500,0 19.685	50,0 1.969	35,0 1.378	80 3.150	24,0 0.945	70,0 1015.3	0,7 1.540	4,0 0.157	5,0 44.3	LC..1604..
Grooving	C5-CFOR-35085-05R080055-JET	02718779	C5	55,0 2.165	80,0 3.150	50,0 1.969	35,0 1.378	85 3.346	30,0 1.181	70,0 1015.3	0,7 1.540	5,0 0.197	5,0 44.3	LC..1605..
	C5-CFOR-35085-05R100070-JET	02718780	C5	70,0 2.756	100,0 3.937	50,0 1.969	35,0 1.378	85 3.346	30,0 1.181	70,0 1015.3	0,7 1.540	5,0 0.197	5,0 44.3	LC..1605..
	C5-CFOR-35085-05R130090-JET	02718781	C5	90,0 3.543	130,0 5.118	50,0 1.969	35,0 1.378	85 3.346	30,0 1.181	70,0 1015.3	0,7 1.540	5,0 0.197	5,0 44.3	LC..1605..
Parting-off	C5-CFOR-35085-05R170110-JET	02718782	C5	110,0 4.331	170,0 6.693	50,0 1.969	35,0 1.378	85 3.346	30,0 1.181	70,0 1015.3	0,7 1.540	5,0 0.197	5,0 44.3	LC..1605..
	C5-CFOR-35085-05R230140-JET	02718783	C5	140,0 5.512	230,0 9.055	50,0 1.969	35,0 1.378	85 3.346	30,0 1.181	70,0 1015.3	0,7 1.540	5,0 0.197	5,0 44.3	LC..1605..
	C5-CFOR-35085-05R500200-JET	02718784	C5	200,0 7.874	500,0 19.685	50,0 1.969	35,0 1.378	85 3.346	30,0 1.181	70,0 1015.3	0,7 1.540	5,0 0.197	5,0 44.3	LC..1605..
X4	C5-CFOL-35085-05L080055-JET	02718755	C5	55,0 2.165	80,0 3.150	50,0 1.969	35,0 1.378	85 3.346	30,0 1.181	70,0 1015.3	0,7 1.540	5,0 0.197	5,0 44.3	LC..1605..
	C5-CFOL-35085-05L100070-JET	02718756	C5	70,0 2.756	100,0 3.937	50,0 1.969	35,0 1.378	85 3.346	30,0 1.181	70,0 1015.3	0,7 1.540	5,0 0.197	5,0 44.3	LC..1605..
	C5-CFOL-35085-05L130090-JET	02718757	C5	90,0 3.543	130,0 5.118	50,0 1.969	35,0 1.378	85 3.346	30,0 1.181	70,0 1015.3	0,7 1.540	5,0 0.197	5,0 44.3	LC..1605..
Adapters Clamping units	C5-CFOL-35085-05L170110-JET	02718758	C5	110,0 4.331	170,0 6.693	50,0 1.969	35,0 1.378	85 3.346	30,0 1.181	70,0 1015.3	0,7 1.540	5,0 0.197	5,0 44.3	LC..1605..
	C5-CFOL-35085-05L230140-JET	02718759	C5	140,0 5.512	230,0 9.055	50,0 1.969	35,0 1.378	85 3.346	30,0 1.181	70,0 1015.3	0,7 1.540	5,0 0.197	5,0 44.3	LC..1605..
	C5-CFOL-35085-05L500200-JET	02718760	C5	200,0 7.874	500,0 19.685	50,0 1.969	35,0 1.378	85 3.346	30,0 1.181	70,0 1015.3	0,7 1.540	5,0 0.197	5,0 44.3	LC..1605..
Accessories and Spare parts	C5-CFOR-35100-06R080055-JET	02718785	C5	55,0 2.165	80,0 3.150	50,0 1.969	35,0 1.378	100 3.937	36,0 1.417	70,0 1015.3	0,9 1.980	6,0 0.236	5,0 44.3	LC..1606..
	C5-CFOR-35100-06R100070-JET	02718786	C5	70,0 2.756	100,0 3.937	50,0 1.969	35,0 1.378	100 3.937	36,0 1.417	70,0 1015.3	0,9 1.980	6,0 0.236	5,0 44.3	LC..1606..
	C5-CFOR-35100-06R130090-JET	02718787	C5	90,0 3.543	130,0 5.118	50,0 1.969	35,0 1.378	100 3.937	36,0 1.417	70,0 1015.3	0,9 1.980	6,0 0.236	5,0 44.3	LC..1606..
Workpiece materials	C5-CFOR-35100-06R170110-JET	02718788	C5	110,0 4.331	170,0 6.693	50,0 1.969	35,0 1.378	100 3.937	36,0 1.417	70,0 1015.3	0,9 1.980	6,0 0.236	5,0 44.3	LC..1606..
	C5-CFOR-35100-06R230140-JET	02718789	C5	140,0 5.512	230,0 9.055	50,0 1.969	35,0 1.378	100 3.937	36,0 1.417	70,0 1015.3	0,9 1.980	6,0 0.236	5,0 44.3	LC..1606..
	C5-CFOR-35100-06R500200-JET	02718790	C5	200,0 7.874	500,0 19.685	50,0 1.969	35,0 1.378	100 3.937	36,0 1.417	70,0 1015.3	0,9 1.980	6,0 0.236	5,0 44.3	LC..1606..
	C5-CFOL-35100-06L080055-JET	02718761	C5	50,0 1.969	80,0 3.150	50,0 1.969	35,0 1.378	100 3.937	36,0 1.417	70,0 1015.3	0,9 1.980	6,0 0.236	5,0 44.3	LC..1606..

Designation	Item number	CTMS	INPLM	INPLX	DCSFM5	WF	LF	CDX**	CP***	Weight	CW	TQ	CTWS
			mm Inch	mm Inch	mm Inch	mm Inch	mm Inch	mm Inch	mm Inch				
C5-CFOL-35100-06L100070-JET	02718762	C5	70,0 2.756	100,0 3.937	50,0 1.969	35,0 1.378	100 3.937	36,0 1.417	70,0 1015.3	0,9 1.980	6,0 0.236	5,0 44.3	LC..1606..
C5-CFOL-35100-06L130090-JET	02718763	C5	90,0 3.543	130,0 5.118	50,0 1.969	35,0 1.378	100 3.937	36,0 1.417	70,0 1015.3	0,9 1.980	6,0 0.236	5,0 44.3	LC..1606..
C5-CFOL-35100-06L170110-JET	02718764	C5	110,0 4.331	170,0 6.693	50,0 1.969	35,0 1.378	100 3.937	36,0 1.417	70,0 1015.3	0,9 1.980	6,0 0.236	5,0 44.3	LC..1606..
C5-CFOL-35100-06L230140-JET	02718765	C5	140,0 5.512	230,0 9.055	50,0 1.969	35,0 1.378	100 3.937	36,0 1.417	70,0 1015.3	0,9 1.980	6,0 0.236	5,0 44.3	LC..1606..
C5-CFOL-35100-06L500200-JET	02718766	C5	200,0 7.874	500,0 19.685	50,0 1.969	35,0 1.378	100 3.937	36,0 1.417	70,0 1015.3	0,9 1.980	6,0 0.236	5,0 44.3	LC..1606..
C6-CFOR-45075-03R080055-JET	02718819	C6	55,0 2.165	80,0 3.150	63,0 2.480	45,0 1.772	75 2.953	18,0 0.709	70,0 1015.3	1,1 2.430	3,0 0.118	5,0 44.3	LC..1603..
C6-CFOR-45075-03R100070-JET	02718820	C6	70,0 2.756	100,0 3.937	63,0 2.480	45,0 1.772	75 2.953	18,0 0.709	70,0 1015.3	1,1 2.430	3,0 0.118	5,0 44.3	LC..1603..
C6-CFOR-45075-03R130090-JET	02718821	C6	90,0 3.543	130,0 5.118	63,0 2.480	45,0 1.772	75 2.953	18,0 0.709	70,0 1015.3	1,1 2.430	3,0 0.118	5,0 44.3	LC..1603..
C6-CFOR-45075-03R170110-JET	02718822	C6	110,0 4.331	170,0 6.693	63,0 2.480	45,0 1.772	75 2.953	18,0 0.709	70,0 1015.3	1,1 2.430	3,0 0.118	5,0 44.3	LC..1603..
C6-CFOR-45075-03R230140-JET	02718823	C6	140,0 5.512	230,0 9.055	63,0 2.480	45,0 1.772	75 2.953	18,0 0.709	70,0 1015.3	1,1 2.430	3,0 0.118	5,0 44.3	LC..1603..
C6-CFOR-45075-03R500200-JET	02718824	C6	200,0 7.874	500,0 19.685	63,0 2.480	45,0 1.772	75 2.953	18,0 0.709	70,0 1015.3	1,1 2.430	3,0 0.118	5,0 44.3	LC..1603..
C6-CFOL-45075-03L080055-JET	02718791	C6	55,0 2.165	80,0 3.150	63,0 2.480	45,0 1.772	75 2.953	18,0 0.709	70,0 1015.3	1,1 2.430	3,0 0.118	5,0 44.3	LC..1603..
C6-CFOL-45075-03L100070-JET	02718792	C6	70,0 2.756	100,0 3.937	63,0 2.480	45,0 1.772	75 2.953	18,0 0.709	70,0 1015.3	1,1 2.430	3,0 0.118	5,0 44.3	LC..1603..
C6-CFOL-45075-03L130090-JET	02718793	C6	90,0 3.543	130,0 5.118	63,0 2.480	45,0 1.772	75 2.953	18,0 0.709	70,0 1015.3	1,1 2.430	3,0 0.118	5,0 44.3	LC..1603..
C6-CFOL-45075-03L170110-JET	02718794	C6	110,0 4.331	170,0 6.693	63,0 2.480	45,0 1.772	75 2.953	18,0 0.709	70,0 1015.3	1,1 2.430	3,0 0.118	5,0 44.3	LC..1603..
C6-CFOL-45075-03L230140-JET	02718795	C6	140,0 5.512	230,0 9.055	63,0 2.480	45,0 1.772	75 2.953	18,0 0.709	70,0 1015.3	1,1 2.430	3,0 0.118	5,0 44.3	LC..1603..
C6-CFOL-45075-03L500200-JET	02718796	C6	200,0 7.874	500,0 19.685	63,0 2.480	45,0 1.772	75 2.953	18,0 0.709	70,0 1015.3	1,1 2.430	3,0 0.118	5,0 44.3	LC..1603..
C6-CFOR-45080-04R080055-JET	02718825	C6	55,0 2.165	80,0 3.150	63,0 2.480	45,0 1.772	80 3.150	24,0 0.945	70,0 1015.3	1,1 2.430	4,0 0.157	5,0 44.3	LC..1604..
C6-CFOR-45080-04R100070-JET	02718826	C6	70,0 2.756	100,0 3.937	63,0 2.480	45,0 1.772	80 3.150	24,0 0.945	70,0 1015.3	1,1 2.430	4,0 0.157	5,0 44.3	LC..1604..
C6-CFOR-45080-04R130090-JET	02718827	C6	90,0 3.543	130,0 5.118	63,0 2.480	45,0 1.772	80 3.150	24,0 0.945	70,0 1015.3	1,1 2.430	4,0 0.157	5,0 44.3	LC..1604..
C6-CFOR-45080-04R170110-JET	02718828	C6	110,0 4.331	170,0 6.693	63,0 2.480	45,0 1.772	80 3.150	24,0 0.945	70,0 1015.3	1,1 2.430	4,0 0.157	5,0 44.3	LC..1604..
C6-CFOR-45080-04R230140-JET	02718829	C6	140,0 5.512	230,0 9.055	63,0 2.480	45,0 1.772	80 3.150	24,0 0.945	70,0 1015.3	1,1 2.430	4,0 0.157	5,0 44.3	LC..1604..
C6-CFOR-45080-04R500200-JET	02718830	C6	200,0 7.874	500,0 19.685	63,0 2.480	45,0 1.772	80 3.150	24,0 0.945	70,0 1015.3	1,1 2.430	4,0 0.157	5,0 44.3	LC..1604..
C6-CFOL-45080-04L080055-JET	02718797	C6	55,0 2.165	80,0 3.150	63,0 2.480	45,0 1.772	80 3.150	24,0 0.945	70,0 1015.3	1,1 2.430	4,0 0.157	5,0 44.3	LC..1604..
C6-CFOL-45080-04L100070-JET	02718798	C6	70,0 2.756	100,0 3.937	63,0 2.480	45,0 1.772	80 3.150	24,0 0.945	70,0 1015.3	1,1 2.430	4,0 0.157	5,0 44.3	LC..1604..
C6-CFOL-45080-04L130090-JET	02718799	C6	90,0 3.543	130,0 5.118	63,0 2.480	45,0 1.772	80 3.150	24,0 0.945	70,0 1015.3	1,1 2.430	4,0 0.157	5,0 44.3	LC..1604..
C6-CFOL-45080-04L170110-JET	02718800	C6	110,0 4.331	170,0 6.693	63,0 2.480	45,0 1.772	80 3.150	24,0 0.945	70,0 1015.3	1,1 2.430	4,0 0.157	5,0 44.3	LC..1604..
C6-CFOL-45080-04L230140-JET	02718801	C6	140,0 5.512	230,0 9.055	63,0 2.480	45,0 1.772	80 3.150	24,0 0.945	70,0 1015.3	1,1 2.430	4,0 0.157	5,0 44.3	LC..1604..
C6-CFOL-45080-04L500200-JET	02718802	C6	200,0 7.874	500,0 19.685	63,0 2.480	45,0 1.772	80 3.150	24,0 0.945	70,0 1015.3	1,1 2.430	4,0 0.157	5,0 44.3	LC..1604..
C6-CFOR-45090-05R080055-JET	02718831	C6	55,0 2.165	80,0 3.150	63,0 2.480	45,0 1.772	90 3.543	30,0 1.181	70,0 1015.3	1,2 2.650	5,0 0.197	5,0 44.3	LC..1605..
C6-CFOR-45090-05R100070-JET	02718832	C6	70,0 2.756	100,0 3.937	63,0 2.480	45,0 1.772	90 3.543	30,0 1.181	70,0 1015.3	1,2 2.650	5,0 0.197	5,0 44.3	LC..1605..

General ISO Turning
Steadyline®
MDT
Mini-Shaft™
Grooving
Parting-off
X4
Adapters Clamping units
Accessories and Spare parts
Workpiece materials



MDT – Multi Directional Turning

Toolholders, external axial, Jetstream Tooling®, Seco-Capto™



	Designation	Item number	CTMS	INPLM	INPLX	DCSFMS	WF	LF	CDX**	CP***	Weight	CW	TQ	CTWS
				mm Inch	mm Inch	mm Inch	mm Inch	mm Inch	mm Inch	mm Inch	mm Inch	bar psi	kg lbs	mm Inch
General ISO Turning	C6-CFOR-45090-05R130090-JET	02718833	C6	90,0 3.543	130,0 5.118	63,0 2.480	45,0 1.772	90 3.543	30,0 1.181	70,0 1015.3	1,2 2.650	5,0 0.197	5,0 44.3	LC..1605..
	C6-CFOR-45090-05R170110-JET	02718834	C6	110,0 4.331	170,0 6.693	63,0 2.480	45,0 1.772	90 3.543	30,0 1.181	70,0 1015.3	1,2 2.650	5,0 0.197	5,0 44.3	LC..1605..
	C6-CFOR-45090-05R230140-JET	02718835	C6	140,0 5.512	230,0 9.055	63,0 2.480	45,0 1.772	90 3.543	30,0 1.181	70,0 1015.3	1,2 2.650	5,0 0.197	5,0 44.3	LC..1605..
Steadyline®	C6-CFOR-45090-05R500200-JET	02718836	C6	200,0 7.874	500,0 19.685	63,0 2.480	45,0 1.772	90 3.543	30,0 1.181	70,0 1015.3	1,2 2.650	5,0 0.197	5,0 44.3	LC..1605..
	C6-CFOL-45090-05L080055-JET	02718803	C6	55,0 2.165	80,0 3.150	63,0 2.480	45,0 1.772	90 3.543	30,0 1.181	70,0 1015.3	1,2 2.650	5,0 0.197	5,0 44.3	LC..1605..
	C6-CFOL-45090-05L100070-JET	02718804	C6	70,0 2.756	100,0 3.937	63,0 2.480	45,0 1.772	90 3.543	30,0 1.181	70,0 1015.3	1,2 2.650	5,0 0.197	5,0 44.3	LC..1605..
MDT	C6-CFOL-45090-05L130090-JET	02718805	C6	90,0 3.543	130,0 5.118	63,0 2.480	45,0 1.772	90 3.543	30,0 1.181	70,0 1015.3	1,2 2.650	5,0 0.197	5,0 44.3	LC..1605..
	C6-CFOL-45090-05L170110-JET	02718806	C6	110,0 4.331	170,0 6.693	63,0 2.480	45,0 1.772	90 3.543	30,0 1.181	70,0 1015.3	1,2 2.650	5,0 0.197	5,0 44.3	LC..1605..
	C6-CFOL-45090-05L230140-JET	02718807	C6	140,0 5.512	230,0 9.055	63,0 2.480	45,0 1.772	90 3.543	30,0 1.181	70,0 1015.3	1,2 2.650	5,0 0.197	5,0 44.3	LC..1605..
Mini-Shaft™	C6-CFOL-45090-05L500200-JET	02718808	C6	200,0 7.874	500,0 19.685	63,0 2.480	45,0 1.772	90 3.543	30,0 1.181	70,0 1015.3	1,2 2.650	5,0 0.197	5,0 44.3	LC..1605..
	C6-CFOR-45100-06R080055-JET	02718837	C6	55,0 2.165	80,0 3.150	63,0 2.480	45,0 1.772	100 3.937	36,0 1.417	70,0 1015.3	1,2 2.650	6,0 0.236	5,0 44.3	LC..1606..
	C6-CFOR-45100-06R100070-JET	02718838	C6	70,0 2.756	100,0 3.937	63,0 2.480	45,0 1.772	100 3.937	36,0 1.417	70,0 1015.3	1,4 3.090	6,0 0.236	5,0 44.3	LC..1606..
Grooving	C6-CFOR-45100-06R130090-JET	02718839	C6	90,0 3.543	130,0 5.118	63,0 2.480	45,0 1.772	100 3.937	36,0 1.417	70,0 1015.3	1,4 3.090	6,0 0.236	5,0 44.3	LC..1606..
	C6-CFOR-45100-06R170110-JET	02718840	C6	110,0 4.331	170,0 6.693	63,0 2.480	45,0 1.772	100 3.937	36,0 1.417	70,0 1015.3	1,3 2.870	6,0 0.236	5,0 44.3	LC..1606..
	C6-CFOR-45100-06R230140-JET	02718841	C6	140,0 5.512	230,0 9.055	63,0 2.480	45,0 1.772	100 3.937	36,0 1.417	70,0 1015.3	1,3 2.870	6,0 0.236	5,0 44.3	LC..1606..
Parting-off	C6-CFOR-45100-06R500200-JET	02718842	C6	200,0 7.874	500,0 19.685	63,0 2.480	45,0 1.772	100 3.937	36,0 1.417	70,0 1015.3	1,3 2.870	6,0 0.236	5,0 44.3	LC..1606..
	C6-CFOL-45100-06L080055-JET	02718809	C6	55,0 2.165	80,0 3.150	63,0 2.480	45,0 1.772	100 3.937	36,0 1.417	70,0 1015.3	1,2 2.650	6,0 0.236	5,0 44.3	LC..1606..
	C6-CFOL-45100-06L100070-JET	02718810	C6	70,0 2.756	100,0 3.937	63,0 2.480	45,0 1.772	100 3.937	36,0 1.417	70,0 1015.3	1,4 3.090	6,0 0.236	5,0 44.3	LC..1606..
X4	C6-CFOL-45100-06L130090-JET	02718811	C6	90,0 3.543	130,0 5.118	63,0 2.480	45,0 1.772	100 3.937	36,0 1.417	70,0 1015.3	1,4 3.090	6,0 0.236	5,0 44.3	LC..1606..
	C6-CFOL-45100-06L170110-JET	02718812	C6	110,0 4.331	170,0 6.693	63,0 2.480	45,0 1.772	100 3.937	36,0 1.417	70,0 1015.3	1,3 2.870	6,0 0.236	5,0 44.3	LC..1606..
	C6-CFOL-45100-06L230140-JET	02718813	C6	140,0 5.512	230,0 9.055	63,0 2.480	45,0 1.772	100 3.937	36,0 1.417	70,0 1015.3	1,3 2.870	6,0 0.236	5,0 44.3	LC..1606..
Adapters Clamping units	C6-CFOR-45100-06L500200-JET	02718814	C6	200,0 7.874	500,0 19.685	63,0 2.480	45,0 1.772	100 3.937	36,0 1.417	70,0 1015.3	1,3 2.870	6,0 0.236	5,0 44.3	LC..1606..
	C6-CFOR-45115-08R130090-JET	02718843	C6	90,0 3.543	130,0 5.118	63,0 2.480	45,0 1.772	115 4.528	48,0 1.890	70,0 1015.3	1,3 2.870	8,0 0.315	10,0 88.5	LC..3008..
	C6-CFOR-45115-08R170110-JET	02718844	C6	110,0 4.331	170,0 6.693	63,0 2.480	45,0 1.772	115 4.528	48,0 1.890	70,0 1015.3	1,5 3.310	8,0 0.315	10,0 88.5	LC..3008..
Accessories and Spare parts	C6-CFOR-45115-08R230140-JET	02718845	C6	140,0 5.512	230,0 9.055	63,0 2.480	45,0 1.772	115 4.528	48,0 1.890	70,0 1015.3	1,3 2.870	8,0 0.315	10,0 88.5	LC..3008..
	C6-CFOR-45115-08R500200-JET	02718846	C6	200,0 7.874	500,0 19.685	63,0 2.480	45,0 1.772	115 4.528	48,0 1.890	70,0 1015.3	1,4 3.090	8,0 0.315	10,0 88.5	LC..3008..
	C6-CFOL-45115-08L130090-JET	02718815	C6	90,0 3.543	130,0 5.118	63,0 2.480	45,0 1.772	115 4.528	48,0 1.890	70,0 1015.3	1,3 2.870	8,0 0.315	10,0 88.5	LC..3008..
Workpiece materials	C6-CFOL-45115-08L170110-JET	02718816	C6	110,0 4.331	170,0 6.693	63,0 2.480	45,0 1.772	115 4.528	48,0 1.890	70,0 1015.3	1,5 3.310	8,0 0.315	10,0 88.5	LC..3008..
	C6-CFOR-45115-08L230140-JET	02718817	C6	140,0 5.512	230,0 9.055	63,0 2.480	45,0 1.772	115 4.528	48,0 1.890	70,0 1015.3	1,3 2.870	8,0 0.315	10,0 88.5	LC..3008..
	C6-CFOR-45115-08L500200-JET	02718818	C6	200,0 7.874	500,0 19.685	63,0 2.480	45,0 1.772	115 4.528	48,0 1.890	70,0 1015.3	1,4 3.090	8,0 0.315	10,0 88.5	LC..3008..

Spare Parts

For size	Clamp key	Clamp screw
		
CFOR/L...-03	4SMS795	TCEI0513
CFOR/L...-04	5SMS795	TCEI0613
CFOR/L...-05	5SMS795	TCEI0613
CFOR/L...-06	6SMS795	TCEI0815
CFOR/L...-08	6SMS795	TCEI1020

- General / ISO Turning
- Steadyline®
- MDT
- Mini-Shaft™
- Grooving
- Parting-off
- X4
- Adapters
Clamping units
- Accessories and
Spare parts
- Workpiece
materials

General ISO Turning

Steadyline®

MDT

Mini-Shaft™

Grooving

Parting-off

X4

Adapters
Clamping units

Accessories and
Spare parts

Workpiece
materials

CFIR/L...JETI – Toolholders compatible with JETI adapters for inserts LCGF, LCGN, LCMF and LCMR – Metric



CFIR/L2020...JETI

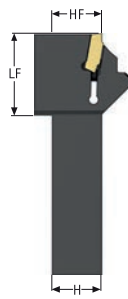
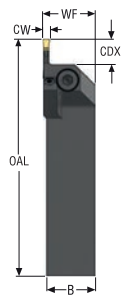

CFIR/L2525...JETI

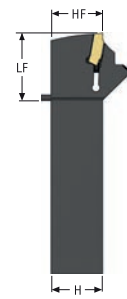
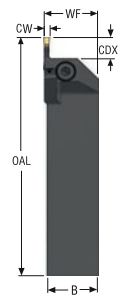



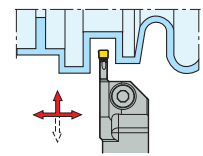

CFIR/L
KAPR = 90,0 °



- For inserts program, see page(s) 839-852, 854-855
- For suitable adapter, see page(s) 962-973
- For more information on Jetstream Tooling® (High pressure coolant) and accessories, please see page(s) 38, 85-89, 1002
- CTWS = Insert shape and size
- ** Max depth of cut for double-sided LCGF/LCMF16.. = 14 mm, LCGF/LCMF30.. = 28 mm
- *** Max coolant pressure. When using toolholder together with an adapter the maximum coolant pressure might be limited, please see page(s) 85
- CDX = 3 x CW
- Right-hand version shown
- Please check availability at www.secotools.com / Seco Online Store

Designation	Item number	H	B	OAL	LF	WF	HF	CDX**	CP***	Weight	CW	TQ	CTWS
		mm	mm	mm	mm	mm	mm	mm	bar	kg	mm	Nm	
CFIR2020X03JETI	03244706	20	20	97	33	21,5	19,95	9,0	200,0	0,3	3,0	6,0	LC..1603..
CFIR2525X03JETI	03244716	25	25	117	33	26,5	24,95	9,0	200,0	0,5	3,0	6,0	LC..1603..
CFIL2020X03JETI	03244721	20	20	97	33	21,5	19,95	9,0	200,0	0,3	3,0	6,0	LC..1603..
CFIL2525X03JETI	03244915	25	25	117	33	26,5	24,95	9,0	200,0	0,1	3,0	6,0	LC..1603..
CFIR2020X04JETI	03244709	20	20	103	39	21,5	19,95	12,0	200,0	0,3	4,0	8,0	LC..1604..
CFIR2525X04JETI	03244722	25	25	123	39	26,5	24,95	12,0	200,0	0,5	4,0	8,0	LC..1604..
CFIL2020X04JETI	03244723	20	20	103	39	21,5	19,95	12,0	200,0	0,3	4,0	8,0	LC..1604..
CFIL2525X04JETI	03244727	25	25	123	39	26,5	24,95	12,0	200,0	0,5	4,0	8,0	LC..1604..
CFIR2020X05JETI	03244732	20	20	104	40	21,5	19,95	15,0	200,0	0,3	5,0	8,0	LC..1605..
CFIR2525X05JETI	03244725	25	25	124	40	26,5	24,95	15,0	200,0	0,6	5,0	8,0	LC..1605..
CFIL2020X05JETI	03244739	20	20	104	40	21,5	19,95	15,0	200,0	0,3	5,0	8,0	LC..1605..
CFIL2525X05JETI	03244726	25	25	124	40	26,5	24,95	15,0	200,0	0,6	5,0	8,0	LC..1605..
CFIR2020X06JETI	03244742	20	20	111	47	21,5	19,95	18,0	200,0	0,5	6,0	8,0	LC..1606..
CFIR2525X06JETI	03244731	25	25	131	47	26,5	24,95	18,0	200,0	0,6	6,0	10,0	LC..1606..
CFIL2020X06JETI	03244745	20	20	111	47	21,5	19,95	18,0	200,0	0,4	6,0	8,0	LC..1606..
CFIL2525X06JETI	03244737	25	25	131	47	26,5	24,95	18,0	200,0	0,6	6,0	10,0	LC..1606..
CFIR2525X08JETI	03244740	25	25	142	58	28,0	24,95	24,0	200,0	0,6	8,0	15,0	LC..3008..
CFIL2525X08JETI	03244744	25	25	142	58	28,0	24,95	24,0	200,0	0,6	8,0	15,0	LC..3008..

Spare Parts

For size	Clamp key	Clamp screw	Plug	Plug screw
				
CFIR/L...-03	4SMS795	TCEI0513	JET-P1/8-5MM	P6SS6X6
CFIR/L...-04	5SMS795	TCEI0613	JET-P1/8-5MM	P6SS6X6
CFIR/L...-05	5SMS795	TCEI0613	JET-P1/8-5MM	P6SS6X6
CFIR/L20...-06	5SMS795	TCEI0613	JET-P1/8-5MM	P6SS6X6
CFIR/L25...-06	6SMS795	TCEI0815	JET-P1/8-5MM	P6SS6X6
CFIR/L...-08	6SMS795	TCEI1020	JET-P1/8-5MM	P6SS6X6

- General ISO Turning
- Steadyline®
- MDT
- Mini-Shaft™
- Grooving
- Parting-off
- X4
- Adapters Clamping units
- Accessories and Spare parts
- Workpiece materials

General ISO Turning

Steadyline®

MDT

Mini-Shaft™

Grooving

Parting-off

X4

Adapters
Clamping units

Accessories and
Spare parts

Workpiece
materials

CFIR/L...JET – Toolholders for inserts LCGF, LCGN, LCMF and LCMR – Metric



CTWS

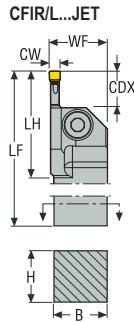

CFIR/L
KAPR = 90,0 °

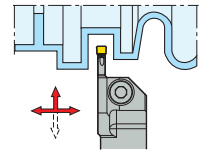

- For inserts program, see page(s) 839-852, 854-855
- For more information on Jetstream Tooling® (High pressure coolant) and accessories, please see page(s) 38, 85-89, 1002
- CTWS = Insert shape and size
- ** Max depth of cut for double-sided LCGF/LCMF16.. = 14 mm, LCGF/LCMF30.. = 28 mm
- *** Max coolant pressure using hose connection
- CDX = 3 x CW
- Right-hand version shown
- Please check availability at www.secotools.com / Seco Online Store

Designation	Item number	H	B	LF	WF	LH	CDX**	CP***	Weight	CW	TQ	CTWS
		mm	mm	mm	mm	mm	mm	bar	kg	mm	Nm	
CFIR3225P03JET	02599873	32	25	170	26,5	33,0	9,0	275,0	1,0	3,0	6,0	LC..1603..
CFIL3225P03JET	02599874	32	25	170	26,5	33,0	9,0	275,0	1,0	3,0	6,0	LC..1603..
CFIR3225P04JET	02599879	32	25	170	26,5	39,0	12,0	275,0	1,0	4,0	8,0	LC..1604..
CFIL3225P04JET	02599880	32	25	170	26,5	39,0	12,0	275,0	1,0	4,0	8,0	LC..1604..
CFIR3225P05JET	02599886	32	25	170	26,5	40,0	15,0	275,0	1,0	5,0	8,0	LC..1605..
CFIL3225P05JET	02599887	32	25	170	26,5	40,0	15,0	275,0	1,0	5,0	8,0	LC..1605..
CFIR3225P06JET	02599892	32	25	170	26,5	47,0	18,0	275,0	1,0	6,0	8,0	LC..1606..
CFIL3225P06JET	02599893	32	25	170	26,5	47,0	18,0	275,0	1,0	6,0	8,0	LC..1606..
CFIR3225P08JET	02641519	32	25	170	28,0	57,0	24,0	275,0	1,0	8,0	8,0	LC..3008..
CFIL3225P08JET	02641520	32	25	170	28,0	57,0	24,0	275,0	1,0	8,0	8,0	LC..3008..

Spare Parts

For size	Clamp key	Clamp screw	Plug
CFIR/L...-03	4SMS795	TCEI0513	JET-P1/8-5MM
CFIR/L...-04	5SMS795	TCEI0613	JET-P1/8-5MM
CFIR/L...-05	5SMS795	TCEI0613	JET-P1/8-5MM
CFIR/L...-06	6SMS795	TCEI0815	JET-P1/8-5MM
CFIR/L...-08	6SMS795	TCEI1020	JET-P1/8-5MM

CFIR/L...JET – Toolholders for inserts LCGF, LCGN, LCMF and LCMR – Inch

CFIR/L
KAPR = 90,0°

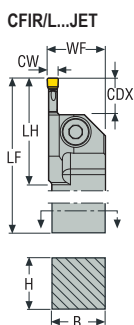
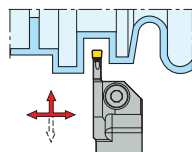



- For inserts program, see page(s) 839-852, 854-855
- For more information on Jetstream Tooling® (High pressure coolant) and accessories, please see page(s) 38, 85-89, 1002
- CTWS = Insert shape and size
- ** Max depth of cut for double-sided LCGF/LCMF16.. = 0.551 inch, LCGF/LCMF30.. = 1.102 inch
- *** Max coolant pressure using hose connection
- CDX = 3 x CW
- Right-hand version shown
- Please check availability at www.secotools.com / Seco Online Store

Designation	Item number	H	B	LF	WF	LH	CDX**	CP***	Weight	CW	TQ	CTWS
		Inch	Inch	Inch	Inch	Inch	Inch	psi	lbs	Inch	In/Lbs.	
CFIR07503BJET	02610615	0.750	0.750	4.500	0.807	1.299	0.354	3988.5	0.880	0.118	53.1	LC..1603..
CFIR10003DJET	02610623	1.000	1.000	6.000	1.055	1.299	0.354	3988.5	1.760	0.118	53.1	LC..1603..
CFIR12503DJET	02610636	1.250	1.250	6.000	1.307	1.299	0.354	3988.5	2.650	0.118	53.1	LC..1603..
CFIL07503BJET	02610616	0.750	0.750	4.500	0.807	1.299	0.354	3988.5	0.880	0.118	53.1	LC..1603..
CFIL10003DJET	02610624	1.000	1.000	6.000	1.055	1.299	0.354	3988.5	1.760	0.118	53.1	LC..1603..
CFIL12503DJET	02610638	1.250	1.250	6.000	1.307	1.299	0.354	3988.5	2.650	0.118	53.1	LC..1603..
CFIR07504BJET	02610617	0.750	0.750	4.500	0.807	1.535	0.472	3988.5	1.100	0.157	70.8	LC..1604..
CFIR10004DJET	02610629	1.000	1.000	6.000	1.055	1.535	0.472	3988.5	1.320	0.157	70.8	LC..1604..
CFIR12504DJET	02610639	1.250	1.250	6.000	1.307	1.535	0.472	3988.5	2.650	0.157	70.8	LC..1604..
CFIL07504BJET	02610618	0.750	0.750	4.500	0.807	1.535	0.472	3988.5	1.100	0.157	70.8	LC..1604..
CFIL10004DJET	02610630	1.000	1.000	6.000	1.055	1.535	0.472	3988.5	1.320	0.157	70.8	LC..1604..
CFIL12504DJET	02610640	1.250	1.250	6.000	1.307	1.535	0.472	3988.5	2.650	0.157	70.8	LC..1604..
CFIR07505BJET	02610619	0.750	0.750	4.500	0.807	1.575	0.591	3988.5	1.100	0.197	70.8	LC..1605..
CFIR10005DJET	02610631	1.000	1.000	6.000	1.055	1.575	0.591	3988.5	1.760	0.197	70.8	LC..1605..
CFIR12505DJET	02610641	1.250	1.250	6.000	1.307	1.575	0.591	3988.5	2.650	0.197	70.8	LC..1605..
CFIL07505BJET	02610620	0.750	0.750	4.500	0.807	1.575	0.591	3988.5	1.100	0.197	70.8	LC..1605..
CFIL10005DJET	02610632	1.000	1.000	6.000	1.055	1.575	0.591	3988.5	1.760	0.197	70.8	LC..1605..
CFIL12505DJET	02610643	1.250	1.250	6.000	1.307	1.575	0.591	3988.5	2.650	0.197	70.8	LC..1605..
CFIR10006DJET	02610634	1.000	1.000	6.000	1.055	1.850	0.709	3988.5	1.760	0.236	88.5	LC..1606..
CFIR12506DJET	02610644	1.250	1.250	6.000	1.307	1.850	0.709	3988.5	2.650	0.236	88.5	LC..1606..
CFIL10006DJET	02610635	1.000	1.000	6.000	1.055	1.850	0.709	3988.5	1.760	0.236	88.5	LC..1606..
CFIL12506DJET	02610645	1.250	1.250	6.000	1.307	1.850	0.709	3988.5	2.650	0.236	88.5	LC..1606..
CFIR10008DJET	02641523	1.000	1.000	6.000	1.114	2.244	0.945	3988.5	1.760	0.315	132.8	LC..3008..
CFIR12508EJET	02641526	1.250	1.250	7.000	1.366	2.244	0.945	3988.5	2.650	0.315	132.8	LC..3008..
CFIL10008DJET	02641524	1.000	1.000	6.000	1.114	2.244	0.945	3988.5	1.760	0.315	132.8	LC..3008..
CFIL12508EJET	02641527	1.250	1.250	7.000	1.366	2.244	0.945	3988.5	2.650	0.315	132.8	LC..3008..

General ISO Turning
Steadyline®
MDT
Mini-Shaft™
Grooving
Parting-off
X4
Adapters
Clamping units
Accessories and Spare parts
Workpiece materials

Spare Parts

For size	Clamp key	Clamp screw	Plug
CFIR/L...03	 4SMS795	 TCEI0513	 JET-P1/8-5MM
CFIR/L...04	5SMS795	TCEI0613	JET-P1/8-5MM
CFIR/L...05	5SMS795	TCEI0613	JET-P1/8-5MM
CFIR/L...06	6SMS795	TCEI0815	JET-P1/8-5MM
CFIR/L...08	6SMS795	TCEI1020	JET-P1/8-5MM

General ISO Turning

Steadyline®

MDT

Mini-Shaft™

Grooving

Parting-off

X4

Adapters
Clamping units

Accessories and
Spare parts

Workpiece
materials

CFMR/L...JET – Toolholders for inserts LCGF, LCGN, LCMF and LCMR – Metric

CFMR/L
KAPR = 90,0°

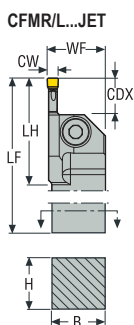
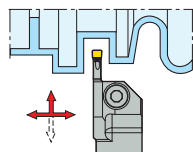

- For inserts program, see page(s) 839-852, 854-855
- For more information on Jetstream Tooling® (High pressure coolant) and accessories, please see page(s) 38, 85-89, 1002
- CTWS = Insert shape and size
- ** Max depth of cut for LCGF/LCMF16.. = 14 mm
- *** Max coolant pressure using hose connection
- CDX = 5 x CW
- Right-hand version shown
- Please check availability at www.secotools.com / Seco Online Store

Designation	Item number	H	B	LF	WF	LH	CDX**	CP***	Weight	CW	TQ	CTWS
		mm	mm	mm	mm	mm	mm	bar	kg	mm	Nm	
CFMR3225P03JET	02702825	32	25	170	26,5	41,0	15,0	275,0	1,0	3,0	6,0	LC..1603..
CFML3225P03JET	02702829	32	25	170	26,5	41,0	15,0	275,0	1,0	3,0	6,0	LC..1603..
CFMR3225P04JET	02702833	32	25	170	26,5	45,0	20,0	275,0	1,0	4,0	8,0	LC..1604..
CFML3225P04JET	02702837	32	25	170	26,5	45,0	20,0	275,0	1,0	4,0	8,0	LC..1604..
CFMR3225P05JET	02702840	32	25	170	26,5	56,0	25,0	275,0	0,9	5,0	8,0	LC..1605..
CFML3225P05JET	02702843	32	25	170	26,5	56,0	25,0	275,0	0,9	5,0	8,0	LC..1605..
CFMR3225P06JET	02702845	32	25	170	26,5	67,0	30,0	275,0	0,9	6,0	10,0	LC..1606..
CFML3225P06JET	02702848	32	25	170	26,5	67,0	30,0	275,0	0,9	6,0	10,0	LC..1606..

Spare Parts

For size	Clamp key	Clamp screw	Plug
CFMR/L...03	4SMS795	TCEI0513	JET-P1/8-5MM
CFMR/L...04	5SMS795	TCEI0613	JET-P1/8-5MM
CFMR/L...05	5SMS795	TCEI0613	JET-P1/8-5MM
CFMR/L...06	6SMS795	TCEI0815	JET-P1/8-5MM

General ISO Turning

Steadyline®

MDT

Mini-Shaft™

Grooving

Parting-off

X4

Adapters
Clamping units

Accessories and
Spare parts

Workpiece
materials

General ISO Turning

Steadyline®

MDT

Mini-Shaft™

Grooving

Parting-off

X4

Adapters
Clamping units

Accessories and
Spare parts

Workpiece
materials

CFMR/L...JET – Toolholders for inserts LCGF, LCGN, LCMF and LCMR – Inch



CTWS

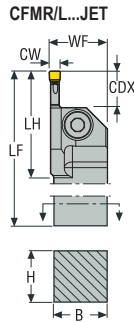

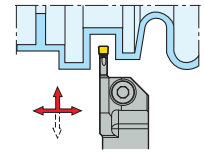

CFMR/L
KAPR = 90,0 °



- For inserts program, see page(s) 839-852, 854-855
- For more information on Jetstream Tooling® (High pressure coolant) and accessories, please see page(s) 38, 85-89, 1002
- CTWS = Insert shape and size
- ** Max depth of cut for LCGF/LCMF16.. = 0,551 inch
- *** Max coolant pressure using hose connection
- CDX = 5 x CW
- Right-hand version shown
- Please check availability at www.secotools.com / Seco Online Store

Designation	Item number	H	B	LF	WF	LH	CDX**	CP***	Weight	CW	TQ	CTWS
		Inch	Inch	Inch	Inch	Inch	Inch	psi	lbs	Inch	In/Lbs.	
CFMR07503BJET	02722319	0.750	0.750	4.500	0.800	1.575	0.591	3988.5	0.880	0.118	53.1	LC..1603..
CFMR10003DJET	02722324	1.000	1.000	6.000	1.040	1.575	0.591	3988.5	1.540	0.118	53.1	LC..1603..
CFMR12503DJET	02722325	1.250	1.250	6.000	1.300	1.732	0.591	3988.5	2.200	0.118	53.1	LC..1603..
CFML07503BJET	02722326	0.750	0.750	4.500	0.800	1.575	0.591	3988.5	0.880	0.118	53.1	LC..1603..
CFML10003DJET	02722327	1.000	1.000	6.000	1.040	1.575	0.591	3988.5	1.540	0.118	53.1	LC..1603..
CFML12503DJET	02722328	1.250	1.250	6.000	1.300	1.732	0.591	3988.5	2.200	0.118	53.1	LC..1603..
CFMR07504BJET	02722329	0.750	0.750	4.500	0.800	1.732	0.787	3988.5	0.880	0.157	70.8	LC..1604..
CFMR10004DJET	02722330	1.000	1.000	6.000	1.040	1.732	0.787	3988.5	1.760	0.157	70.8	LC..1604..
CFMR12504DJET	02722331	1.250	1.250	6.000	1.300	1.732	0.787	3988.5	1.980	0.157	70.8	LC..1604..
CFML07504BJET	02722353	0.750	0.750	4.500	0.800	1.732	0.787	3988.5	0.880	0.157	70.8	LC..1604..
CFML10004DJET	02722354	1.000	1.000	6.000	1.040	1.732	0.787	3988.5	1.760	0.157	70.8	LC..1604..
CFML12504DJET	02722355	1.250	1.250	6.000	1.300	1.732	0.787	3988.5	1.980	0.157	70.8	LC..1604..
CFMR10005DJET	02722356	1.000	1.000	6.000	1.252	1.969	0.984	3988.5	1.320	0.197	70.8	LC..1605..
CFMR12505DJET	02722358	1.250	1.250	6.000	1.300	2.165	0.984	3988.5	1.980	0.197	70.8	LC..1605..
CFML10005DJET	02722359	1.000	1.000	6.000	1.252	1.969	0.984	3988.5	1.320	0.197	70.8	LC..1605..
CFML12505DJET	02722360	1.250	1.250	6.000	1.300	2.165	0.984	3988.5	1.980	0.197	70.8	LC..1605..
CFMR10006DJET	02722361	1.000	1.000	6.000	1.040	2.598	1.181	3988.5	1.320	0.236	88.5	LC..1606..
CFMR12506DJET	02722362	1.250	1.250	6.000	1.300	2.598	1.181	3988.5	1.980	0.236	88.5	LC..1606..
CFML10006DJET	02722363	1.000	1.000	6.000	1.040	2.598	1.181	3988.5	1.320	0.236	88.5	LC..1606..
CFML12506DJET	02722364	1.250	1.250	6.000	1.300	2.598	1.181	3988.5	1.980	0.236	88.5	LC..1606..

Spare Parts

For size	Clamp key	Clamp screw	Plug
			
CFMR/L...03	4SMS795	TCEI0513	JET-P1/8-5MM
CFMR/L...04	5SMS795	TCEI0613	JET-P1/8-5MM
CFMR/L...05	5SMS795	TCEI0613	JET-P1/8-5MM
CFMR/L...06	6SMS795	TCEI0815	JET-P1/8-5MM
CFMR/L...06	5SMS795	TCEI0613	JET-P1/8-5MM

- General ISO Turning
- Steadyline®
- MDT**
- Mini-Shaft™
- Grooving
- Parting-off
- X4
- Adapters
Clamping units
- Accessories and
Spare parts
- Workpiece
materials

CFMR/L...JETI – Toolholders compatible with JETI adapters for inserts LCGF, LCGN, LCMF and LCMR – Metric



CFMR/L2020...JETI

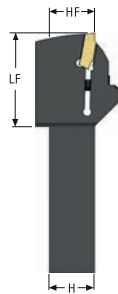

CFMR/L2525...JETI

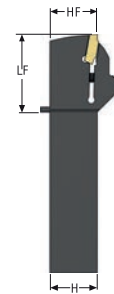

CFMR/L
KAPR = 90,0 °

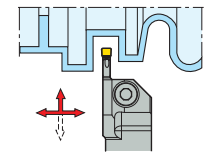

CTWS



- For inserts program, see page(s) 839-852, 854-855
- For suitable adapter, see page(s) 962-973
- For more information on Jetstream Tooling® (High pressure coolant) and accessories, please see page(s) 38, 85-89, 1002
- CTWS = Insert shape and size
- ** Max depth of cut for LCGF/LCMF16.. = 14 mm
- *** Max coolant pressure. When using toolholder together with an adapter the maximum coolant pressure might be limited, please see page(s) 85
- CDX = 5 x CW
- Right-hand version shown
- Please check availability at www.secotools.com / Seco Online Store

Designation	Item number	H	B	OAL	LF	WF	HF	CDX**	CP***	Weight	CW	TQ	CTWS
		mm	mm	mm	mm	mm	mm	mm	bar	kg	mm	Nm	
CFMR2020X03JETI	03244714	20	20	105	41	21,5	19,95	15,0	200,0	0,4	3,0	6,0	LC..1603..
CFMR2525X03JETI	03244710	25	25	125	41	26,5	24,95	15,0	200,0	0,6	3,0	6,0	LC..1603..
CFML2020X03JETI	03244708	20	20	105	41	21,5	19,95	15,0	200,0	0,5	3,0	6,0	LC..1603..
CFML2525X03JETI	03244728	25	25	125	41	26,5	24,95	15,0	200,0	0,5	3,0	6,0	LC..1603..
CFMR2020X04JETI	03244738	20	20	110	46	21,5	19,95	20,0	200,0	0,5	4,0	8,0	LC..1604..
CFMR2525X04JETI	03244718	25	25	130	46	26,5	24,95	20,0	200,0	0,5	4,0	8,0	LC..1604..
CFML2020X04JETI	03244741	20	20	110	46	21,5	19,95	20,0	200,0	0,5	4,0	8,0	LC..1604..
CFML2525X04JETI	03244735	25	25	130	46	26,5	24,95	20,0	200,0	0,5	4,0	8,0	LC..1604..
CFMR2525X05JETI	03244734	25	25	140	56	26,5	24,95	25,0	200,0	0,5	5,0	8,0	LC..1605..
CFML2525X05JETI	03244736	25	25	140	56	26,5	24,95	25,0	200,0	0,5	5,0	8,0	LC..1605..
CFMR2525X06JETI	03244743	25	25	151	67	26,5	24,95	30,0	200,0	0,6	6,0	10,0	LC..1606..
CFML2525X06JETI	03244733	25	25	151	67	26,5	24,95	30,0	200,0	0,6	6,0	10,0	LC..1606..

Spare Parts

For size	Clamp key	Clamp screw	Plug	Plug screw
CFMR/L..-03	4SMS795	TCEI0513	JET-P1/8-5MM	P6SS6X6
CFMR/L..-04	5SMS795	TCEI0613	JET-P1/8-5MM	P6SS6X6
CFMR/L..-05	5SMS795	TCEI0613	JET-P1/8-5MM	P6SS6X6
CFMR/L..-06	6SMS795	TCEI0815	JET-P1/8-5MM	P6SS6X6

CFOR/L..RBJET – Toolholders for inserts LCMF – Metric

CFOR/L
KAPR = 90,0°

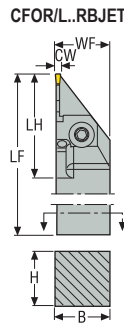
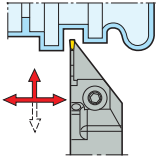

- For inserts program, see page(s) 838
- For more information on Jetstream Tooling® (High pressure coolant) and accessories, please see page(s) 38, 85-89, 1002
- * Due to the design, grooving depth is limited, see page(s) 705
- **** Max coolant pressure using hose connection
- CTWS = Insert shape and size
- RB = Reinforced blade
- CDX = 6 x CW
- Right-hand version shown
- Please check availability at www.secotools.com / Seco Online Store

Designation	Item number	H	B	LF	WF	LH	CUTDIA*	CP***	Weight	CW	TQ	CTWS
		mm	mm	mm	mm	mm	mm	bar	kg	mm	Nm	
CFOR1212K1902RBJET	02828753	12	12	125	12,0	27,0	25,4	275,0	0,2	2,0	5,0	LC..1902..
CFOR1616K1902RBJET	02828755	16	16	125	16,0	27,0	25,4	275,0	0,3	2,0	5,0	LC..1902..
CFOL1212K1902RBJET	02828754	12	12	125	12,0	27,0	25,4	275,0	0,2	2,0	5,0	LC..1902..
CFOL1616K1902RBJET	02828766	16	16	125	16,0	27,0	25,4	275,0	0,3	2,0	5,0	LC..1902..

Spare Parts

For size	Clamp key	Clamp screw
CFOR/L..19	T15P-7S	L85012-T15P

Accessories

For size	Coolant adapter	Washer
CFOR/L..19	JET-ADM6	JET-CS0610

General ISO Turning

Steadyline®

MDT

Mini-Shaft™

Grooving

Parting-off

X4

Adapters
Clamping units

Accessories and
Spare parts

Workpiece
materials

General ISO Turning

CFOR/L...RBJET – Toolholders for inserts LCMF – Inch

Steadyline®



CTWS

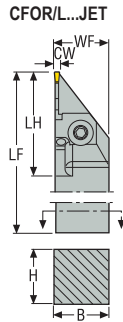

CFOR/L
KAPR = 90,0 °

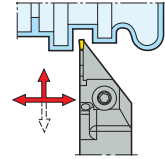

MDT

- For inserts program, see page(s) 838
- For more information on Jetstream Tooling® (High pressure coolant) and accessories, please see page(s) 38, 85-89, 1002
- * Due to the design, grooving depth is limited, see page(s) 705
- *** Max coolant pressure using hose connection
- CTWS = Insert shape and size
- RB = Reinforced blade
- CDX = 6 x CW
- Right-hand version shown
- Please check availability at www.secotools.com / Seco Online Store

Mini-Shaft™

Grooving

Designation	Item number	H	B	LF	WF	LH	CUTDIA*	CP***	Weight	CW	TQ	CTWS
		Inch	Inch	Inch	Inch	Inch	Inch	psi	lbs	Inch	In/Lbs.	
CFOR0501902CRBJET	02828756	0.500	0.500	4.921	0.500	1.063	1.000	3988.5	0.440	0.079	44.3	LC..1902..
CFOR0631902CRBJET	02828758	0.500	0.500	4.921	0.500	1.063	1.000	3988.5	0.660	0.079	44.3	LC..1902..
CFOL0501902CRBJET	02828757	0.500	0.500	4.921	0.500	1.063	1.000	3988.5	0.440	0.079	44.3	LC..1902..
CFOL0631902CRBJET	02828767	0.500	0.500	4.921	0.500	1.063	1.000	3988.5	0.660	0.079	44.3	LC..1902..

Parting-off

Spare Parts

For size	Clamp key	Clamp screw
CFOR/L..-02	T15P-7S	L85012-T15P

X4

Accessories

For size	Coolant adapter	Washer
CFOR/L..-02	JET-ADM6	JET-CS0610

Adapters
Clamping units

Accessories and
Spare parts

Workpiece
materials

CFSR/L..RBJET – Toolholders for inserts LCMF – Metric

CFSR/L
KAPR = 90,0°

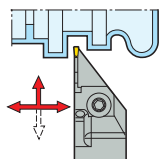

CFSR/L..RBJETI

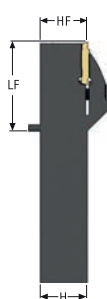
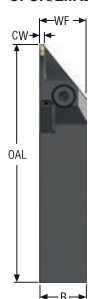

CTWS



- For inserts program, see page(s) 838
- For suitable adapter, see page(s) 962-973
- For more information on Jetstream Tooling® (High pressure coolant) and accessories, please see page(s) 38, 85-89, 1002
- * Due to the design, grooving depth is limited, see page(s) 705
- *** Max coolant pressure. When using toolholder together with an adapter the maximum coolant pressure might be limited, please see page(s) 85
- CTWS = Insert shape and size
- RB = Reinforced blade
- CDX = 8 x CW
- Right-hand version shown
- Please check availability at www.secotools.com / Seco Online Store

Designation	Item number	H	B	OAL	LF	WF	HF	CUTDIA*	CP***	Weight	CW	TQ	CTWS
		mm	mm	mm	mm	mm	mm	mm	bar	kg	mm	Nm	
CFSR2020X1902RBJETI	03244707	20	20	102	38	20,0	19,95	33,0	200,0	0,3	2,0	6,0	LC..1902..
CFSL2020X1902RBJETI	03244713	20	20	102	38	20,0	19,95	33,0	200,0	0,3	2,0	6,0	LC..1902..

Spare Parts

For size	Clamp key	Clamp screw	Plug	Plug screw
CFSR/L..19	4SMS795	TCEI0513	JET-P1/8-5MM	P6SS6X6

General ISO Turning

Steadyline®

MDT

Mini-Shaft™

Grooving

Parting-off

X4

Adapters
Clamping units

Accessories and
Spare parts

Workpiece
materials

General ISO Turning

CFSR/L...RBJET – Toolholders for inserts LCMF – Inch

Steadyline®

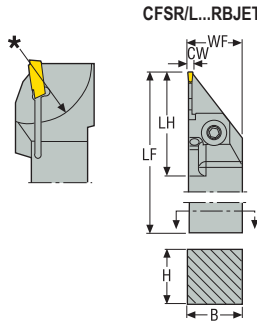

CFSR/L
KAPR = 90,0 °

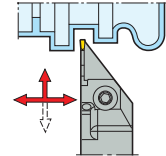

CTWS



MDT

- For inserts program, see page(s) 838
- For more information on Jetstream Tooling® (High pressure coolant) and accessories, please see page(s) 38, 85-89, 1002
- * Due to the design, grooving depth is limited, see page(s) 705
- *** Max coolant pressure. When using toolholder together with an adapter the maximum coolant pressure might be limited, please see page(s) 85
- CTWS = Insert shape and size
- RB = Reinforced blade
- CDX = 8 x CW
- Right-hand version shown
- Please check availability at www.secotools.com / Seco Online Store

Mini-Shaft™

Grooving

Designation	Item number	H	B	LF	WF	LH	CUTDIA*	CP***	Weight	CW	TQ	CTWS
		Inch	Inch	Inch	Inch	Inch	Inch	psi	lbs	Inch	In/Lbs.	
CFSR0751902DRBJET	02748837	0.750	0.750	6.000	0.750	1.500	1.299	3988.5	0.880	0.079	53.1	LC..1902..
CFSL0751902DRBJET	02748840	0.750	0.750	6.000	0.750	1.500	1.299	3988.5	0.880	0.079	53.1	LC..1902..

Spare Parts

Parting-off

For size	Clamp key	Clamp screw	Plug
CFSR/L...-02	4SMS795	TCEI0513	JET-P1/8-5MM

X4

Adapters
Clamping units

Accessories and
Spare parts

Workpiece
materials

CFZR/L...JETI – Toolholders compatible with JETI adapters for inserts LCMF – Metric

CFZR/L
KAPR = 90,0°

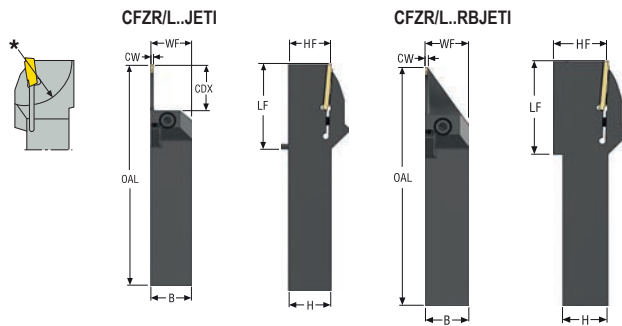
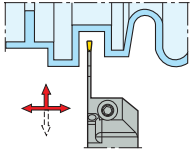

- For inserts program, see page(s) 838
- For suitable adapter, see page(s) 962-973
- For more information on Jetstream Tooling® (High pressure coolant) and accessories, please see page(s) 38, 85-89, 1002
- * Due to the design, grooving depth is limited, see page(s) 705
- *** Max coolant pressure. When using toolholder together with an adapter the maximum coolant pressure might be limited, please see page(s) 85
- CTWS = Insert shape and size
- RB = Reinforced blade
- CDX = 12,5 x CW
- Right-hand version shown
- Please check availability at www.secotools.com / Seco Online Store

Designation	Item number	H	B	OAL	LF	WF	HF	CDX**	CUTDIA	CP***	Weight	CW	TQ	CTWS
		mm	mm	mm	mm	mm	mm	mm	mm	bar	kg	mm	Nm	
CFZR2020X2802JETI	03244729	20	20	115	51	20,0	19,95	26,0	-	200,0	0,3	2,0	6,0	LC..2802..
CFZR2525X2802JETI	03244712	25	25	135	51	25,0	24,95	26,0	56,2	200,0	0,5	2,0	6,0	LC..2802..
CFZL2020X2802JETI	03244730	20	20	115	51	20,0	19,95	26,0	-	200,0	0,3	2,0	6,0	LC..2802..
CFZL2525X2802JETI	03244719	25	25	135	51	25,0	24,95	26,0	56,2	200,0	0,5	2,0	6,0	LC..2802..
CFZR2020X2802RBJETI	03244715	20	20	116	52	20,0	19,95	-	52,0	200,0	0,4	2,0	6,0	LC..2802..
CFZR2525X2802RBJETI	03244711	25	25	136	52	25,0	24,95	-	52,0	200,0	0,6	2,0	6,0	LC..2802..
CFZL2020X2802RBJETI	03244717	20	20	116	52	20,0	19,95	-	52,0	200,0	0,4	2,0	6,0	LC..2802..
CFZL2525X2802RBJETI	03244720	25	25	136	52	25,0	24,95	-	52,0	200,0	0,6	2,0	6,0	LC..2802..

Spare Parts

For size	Clamp key	Clamp screw	Plug	Plug screw
CFZR/L...28	4SMS795	TCEI0513	JET-P1/8-5MM	P6SS6X6

General ISO Turning

Steadyline®

MDT

Mini-Shaft™

Grooving

Parting-off

X4

Adapters
Clamping units

Accessories and
Spare parts

Workpiece
materials

General ISO Turning

CFZR/L...JETI – Toolholders for inserts LCMF – Inch

Steadyline®

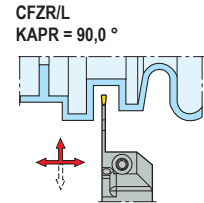
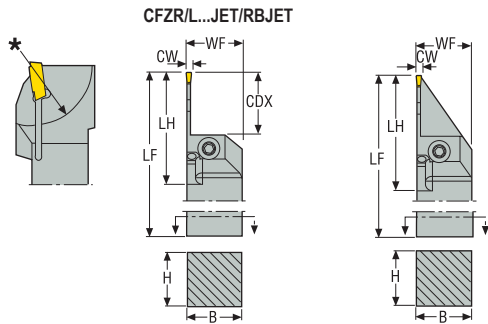

CTWS



MDT

- For inserts program, see page(s) 838
- For more information on Jetstream Tooling® (High pressure coolant) and accessories, please see page(s) 38, 85-89, 1002
- * Due to the design, grooving depth is limited, see page(s) 705
- *** Max coolant pressure. When using toolholder together with an adapter the maximum coolant pressure might be limited, please see page(s) 85
- CTWS = Insert shape and size
- RB = Reinforced blade
- CDX = 12,5 x CW
- Right-hand version shown
- Please check availability at www.secotools.com / Seco Online Store

Mini-Shaft™

Grooving

Designation	Item number	H	B	LF	WF	LH	CUTDIA*	CP***	Weight	CW	TQ	CTWS
		Inch	Inch	Inch	Inch	Inch	Inch	psi	lbs	Inch	In/Lbs.	
CFZR0752802DJET	02749013	0.750	0.750	6.000	0.750	1.969	–	3988.5	0.880	0.079	53.1	LC..2802..
CFZR1002802DJET	02749006	1.000	1.000	6.000	1.000	1.969	–	3988.5	1.540	0.079	53.1	LC..2802..
CFZL0752802DJET	02749008	0.750	0.750	6.000	0.750	1.969	–	3988.5	0.880	0.079	53.1	LC..2802..
CFZL1002802DJET	02749010	1.000	1.000	6.000	1.000	1.969	–	3988.5	1.540	0.079	53.1	LC..2802..
CFZR0752802DRBJET	02748941	0.750	0.750	6.000	0.750	2.028	2.047	3988.5	0.880	0.079	53.1	LC..2802..
CFZR1002802DRBJET	02749014	1.000	1.000	6.000	1.000	2.028	2.047	3988.5	0.440	0.079	53.1	LC..2802..
CFZL0752802DRBJET	02749016	0.750	0.750	6.000	0.750	2.028	2.047	3988.5	0.880	0.079	53.1	LC..2802..
CFZL1002802DRBJET	02749017	1.000	1.000	6.000	1.000	2.028	2.047	3988.5	0.440	0.079	53.1	LC..2802..

Parting-off

Spare Parts

X4

For size	Clamp key	Clamp screw	Plug
CFZR/L..02	4SMS795	TCEI0513	JET-P1/8-5MM

Adapters Clamping units

Accessories and Spare parts

Workpiece materials

CFIR...L...JET, CFIL...R...JETI – Toolholders compatible with JETI adapters for inserts LCGF, LCGN, LCMF and LCMR – Metric

CFIR/L
KAPR = 90,0°

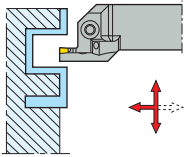

CFIR...L...JETI, CFIL...R...JETI

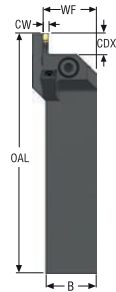

CTWS

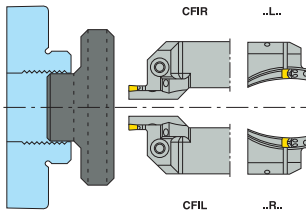

- For inserts program, see page(s) 839-844, 854-855
- For suitable adapter, see page(s) 962-973
- For more information on Jetstream Tooling® (High pressure coolant) and accessories, please see page(s) 38, 85-89, 1002
- CTWS = Insert shape and size
- Initial plunge (INPLM/INPLX) relates to face groove diameter, see page(s) 705
- *** Max coolant pressure. When using toolholder together with an adapter the maximum coolant pressure might be limited, please see page(s) 85
- CDX = 3 x CW
- Right-hand version with left-hand blade shown
- Please check availability at www.secotools.com / Seco Online Store

Designation	Item number	INPLM	INPLX	H	B	OAL	LF	WF	HF	CDX**	CP***	Weight	CW	TQ	CTWS
		mm	mm	mm	mm	mm	mm	mm	mm	mm	bar	kg	mm	Nm	
CFIR2525X03L080055-JETI	03244842	55,0	80,0	25	25	118	34	26,5	24,95	9,0	200,0	0,3	3,0	5,0	LC..1603..
CFIL2525X03R080055-JETI	03244787	55,0	80,0	25	25	118	34	26,5	24,95	9,0	200,0	0,5	3,0	5,0	LC..1603..
CFIL2525X04R080055-JETI	03244776	55,0	80,0	25	25	121	37	26,5	24,95	12,0	200,0	0,5	4,0	5,0	LC..1604..
CFIR2525X04L080055-JETI	03244808	55,0	80,0	25	25	121	37	26,5	24,95	12,0	200,0	0,6	4,0	5,0	LC..1604..
CFIL2525X05R080055-JETI	03244758	55,0	80,0	25	25	125	41	26,5	24,95	15,0	200,0	0,6	5,0	5,0	LC..1605..
CFIR2525X05L080055-JETI	03244904	55,0	80,0	25	25	125	41	26,5	24,95	15,0	200,0	0,5	5,0	5,0	LC..1605..
CFIL2525X06R080055-JETI	03244850	55,0	80,0	25	25	131	47	26,5	24,95	18,0	200,0	0,5	6,0	5,0	LC..1606..
CFIR2525X06L080055-JETI	03244798	55,0	80,0	25	25	131	47	26,5	24,95	18,0	200,0	0,6	6,0	5,0	LC..1606..

Spare Parts

For size	Clamp key	Clamp screw	Plug	Plug screw
CFIR/L...-03	4SMS795	TCEI0513	JET-P1/8-5MM	P6SS6X6
CFIR/L...-04	5SMS795	TCEI0613	JET-P1/8-5MM	P6SS6X6
CFIR/L...-05	5SMS795	TCEI0613	JET-P1/8-5MM	P6SS6X6
CFIR/L...-06	6SMS795	TCEI0815	JET-P1/8-5MM	P6SS6X6

General ISO Turning

Steadyline®

MDT

Mini-Shaft™

Grooving

Parting-off

X4

Adapters Clamping units

Accessories and Spare parts

Workpiece materials

CFIR...L...JET, CFIL...R...JETI – Toolholders for inserts LCGF, LCGN, LCMF and LCMR – Inch

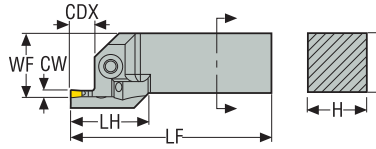

KAPR = 90,0 °

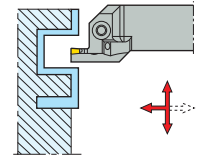

CTWS



- For inserts program, see page(s) 839-844, 854-855
- For more information on Jetstream Tooling® (High pressure coolant) and accessories, please see page(s) 38, 85-89, 1002
- CTWS = Insert shape and size
- Initial plunge (INPLM/INPLX) relates to face groove diameter, see page(s) 705
- *** Max coolant pressure. When using toolholder together with an adapter the maximum coolant pressure might be limited, please see page(s) 85
- CDX = 3 x CW
- Right-hand version with left-hand blade shown
- Please check availability at www.secotools.com / Seco Online Store

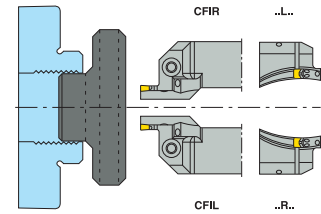

Designation	Item number	INPLM	INPLX	H	B	LF	WF	WF2	LH	CDX**	CP***	Weight	CW	TQ	CTWS
		Inch	Inch	Inch	Inch	Inch	Inch	Inch	Inch	Inch	psi	lbs	Inch	In/Lbs.	
CFIR10003D-L3.102.17-JET	02718983	2.165	3.150	1.000	1.000	6.000	1.043	-	1.299	0.354	3988.5	1.980	0.118	53.1	LC..1603..
CFIR10004D-L3.102.17-JET	02718984	2.165	3.150	1.000	1.000	6.000	1.043	-	1.417	0.472	3988.5	1.760	0.157	70.8	LC..1604..
CFIR10005D-L3.102.17-JET	02718985	2.165	3.150	1.000	1.000	6.000	1.043	-	1.575	0.591	3988.5	1.980	0.197	70.8	LC..1605..
CFIR10006D-L3.102.17-JET	02718986	2.165	3.150	1.000	1.000	6.000	1.043	-	1.811	0.709	3988.5	1.980	0.236	88.5	LC..1606..
CFIL10003D-R3.102.17-JET	02717498	2.165	3.150	1.000	1.000	6.000	1.043	-	1.299	0.354	3988.5	1.760	0.118	53.1	LC..1603..
CFIL10004D-R3.102.17-JET	02718958	2.165	3.150	1.000	1.000	6.000	1.043	-	1.417	0.472	3988.5	1.980	0.157	70.8	LC..1604..
CFIL10005D-R3.102.17-JET	02718981	2.165	3.150	1.000	1.000	6.000	1.043	-	1.575	0.591	3988.5	1.980	0.197	70.8	LC..1605..
CFIL10006D-R3.102.17-JET	02718982	2.165	3.150	1.000	1.000	6.000	1.043	-	1.811	0.709	3988.5	1.760	0.236	88.5	LC..1606..

Spare Parts

For size	Clamp key	Clamp screw	Plug
..3D	4SMS795	TCEI0513	JET-P1/8-5MM
..4D	5SMS795	TCEI0613	JET-P1/8-5MM
..5D	5SMS795	TCEI0613	JET-P1/8-5MM
..6D-L	5SMS795	TCEI0613	JET-P1/8-5MM
..6D-R	6SMS795	TCEI0815	JET-P1/8-5MM

CFIR...R...JETI, CFIL...L...JETI – Toolholders compatible with JETI adapters for inserts LCGF, LCGN, LCMF and LCMR – Metric

CFIR/L
KAPR = 90,0°

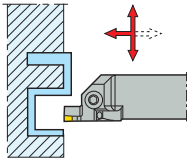

CFIR...R...JETI, CFIL...L...JETI

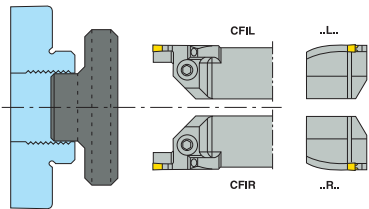
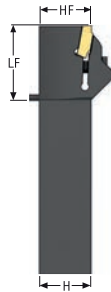
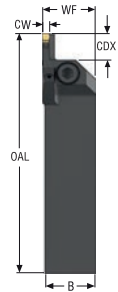

- For inserts program, see page(s) 839-844, 854-855
- For suitable adapter, see page(s) 962-973
- For more information on Jetstream Tooling® (High pressure coolant) and accessories, please see page(s) 38, 85-89, 1002
- CTWS = Insert shape and size
- Initial plunge (INPLM/INPLX) relates to face groove diameter, see page(s) 705
- *** Max coolant pressure. When using toolholder together with an adapter the maximum coolant pressure might be limited, please see page(s) 85
- CDX = 3 x CW
- Right-hand version with right-hand blade shown
- Please check availability at www.secotools.com / Seco Online Store

Designation	Item number	INPLM	INPLX	H	B	OAL	LF	WF	HF	CDX**	CP***	Weight	CW	TQ	CTWS
		mm	mm	mm	mm	mm	mm	mm	mm	mm	bar	kg	mm	Nm	
CFIR2525X03R080055-JETI	03244862	55,0	80,0	25	25	118	34	26,5	24,95	9,0	200,0	0,5	3,0	5,0	LC..1603..
CFIR2525X03R100070-JETI	03244807	70,0	100,0	25	25	118	34	26,5	24,95	9,0	200,0	0,5	3,0	5,0	LC..1603..
CFIR2525X03R130090-JETI	03244843	90,0	130,0	25	25	118	34	26,5	24,95	9,0	200,0	0,3	3,0	5,0	LC..1603..
CFIR2525X03R170110-JETI	03244903	110,0	170,0	25	25	118	34	26,5	24,95	9,0	200,0	0,5	3,0	5,0	LC..1603..
CFIL2525X03L080055-JETI	03244846	55,0	80,0	25	25	118	34	26,5	24,95	9,0	200,0	0,1	3,0	5,0	LC..1603..
CFIL2525X03L100070-JETI	03244879	70,0	100,0	25	25	118	34	26,5	24,95	9,0	200,0	0,5	3,0	5,0	LC..1603..
CFIL2525X03L130090-JETI	03244910	90,0	130,0	25	25	118	34	26,5	24,95	9,0	200,0	0,4	3,0	5,0	LC..1603..
CFIL2525X03L170110-JETI	03244911	110,0	170,0	25	25	118	34	26,5	24,95	9,0	200,0	0,1	3,0	5,0	LC..1603..
CFIR2525X04R080055-JETI	03244809	55,0	80,0	25	25	121	37	26,5	24,95	12,0	200,0	0,1	4,0	5,0	LC..1604..
CFIR2525X04R100070-JETI	03244822	70,0	100,0	25	25	121	37	26,5	24,95	12,0	200,0	0,3	4,0	5,0	LC..1604..
CFIR2525X04R130090-JETI	03244810	90,0	130,0	25	25	121	37	26,5	24,95	12,0	200,0	0,5	4,0	5,0	LC..1604..
CFIR2525X04R170110-JETI	03244844	110,0	170,0	25	25	121	37	26,5	24,95	12,0	200,0	0,1	4,0	5,0	LC..1604..
CFIR2525X04R230140-JETI	03244781	140,0	230,0	25	25	121	37	26,5	24,95	12,0	200,0	0,6	4,0	5,0	LC..1604..
CFIL2525X04L080055-JETI	03244847	55,0	80,0	25	25	121	37	26,5	24,95	12,0	200,0	0,6	4,0	5,0	LC..1604..
CFIL2525X04L100070-JETI	03244912	70,0	100,0	25	25	121	37	26,5	24,95	12,0	200,0	0,5	4,0	5,0	LC..1604..
CFIL2525X04L130090-JETI	03244823	90,0	130,0	25	25	121	37	26,5	24,95	12,0	200,0	0,6	4,0	5,0	LC..1604..
CFIL2525X04L170110-JETI	03244848	110,0	170,0	25	25	121	37	26,5	24,95	12,0	200,0	0,1	4,0	5,0	LC..1604..
CFIL2525X04L230140-JETI	03244799	140,0	230,0	25	25	121	37	26,5	24,95	12,0	200,0	0,5	4,0	5,0	LC..1604..
CFIR2525X05R080055-JETI	03244876	55,0	80,0	25	25	125	41	26,5	24,95	15,0	200,0	0,5	5,0	5,0	LC..1605..
CFIR2525X05R100070-JETI	03244863	70,0	100,0	25	25	125	41	26,5	24,95	15,0	200,0	0,1	5,0	5,0	LC..1605..
CFIR2525X05R130090-JETI	03244877	90,0	130,0	25	25	125	41	26,5	24,95	15,0	200,0	0,3	5,0	5,0	LC..1605..
CFIR2525X05R170110-JETI	03244786	110,0	170,0	25	25	125	41	26,5	24,95	15,0	200,0	0,5	5,0	5,0	LC..1605..
CFIR2525X05R230140-JETI	03244864	140,0	230,0	25	25	125	41	26,5	24,95	15,0	200,0	0,5	5,0	5,0	LC..1605..
CFIL2525X05L080055-JETI	03244913	55,0	80,0	25	25	125	41	26,5	24,95	15,0	200,0	0,5	5,0	5,0	LC..1605..
CFIL2525X05L100070-JETI	03244849	70,0	100,0	25	25	125	41	26,5	24,95	15,0	200,0	0,5	5,0	5,0	LC..1605..
CFIL2525X05L130090-JETI	03244812	90,0	130,0	25	25	125	41	26,5	24,95	15,0	200,0	0,4	5,0	5,0	LC..1605..
CFIL2525X05L170110-JETI	03244880	110,0	170,0	25	25	125	41	26,5	24,95	15,0	200,0	0,5	5,0	5,0	LC..1605..
CFIL2525X05L230140-JETI	03244788	140,0	230,0	25	25	125	41	26,5	24,95	15,0	200,0	0,5	5,0	5,0	LC..1605..
CFIR2525X06R080055-JETI	03244905	55,0	80,0	25	25	131	47	26,5	24,95	18,0	200,0	0,1	6,0	5,0	LC..1606..

General ISO Turning	Designation	Item number	INPLM	INPLX	H	B	OAL	LF	WF	HF	CDX**	CP***	Weight	CW	TQ	CTWS
			mm	mm	mm	mm	mm	mm	mm	mm	mm	bar	kg	mm	Nm	
	CFIR2525X06R100070-JETI	03244811	70,0	100,0	25	25	131	47	26,5	24,95	18,0	200,0	0,6	6,0	5,0	LC..1606..
	CFIR2525X06R130090-JETI	03244906	90,0	130,0	25	25	131	47	26,5	24,95	18,0	200,0	0,1	6,0	5,0	LC..1606..
	CFIR2525X06R170110-JETI	03244878	110,0	170,0	25	25	131	47	26,5	24,95	18,0	200,0	0,6	6,0	5,0	LC..1606..
	CFIR2525X06R230140-JETI	03244782	140,0	230,0	25	25	131	47	26,5	24,95	18,0	200,0	0,6	6,0	5,0	LC..1606..
	CFIL2525X06L080055-JETI	03244813	55,0	80,0	25	25	131	47	26,5	24,95	18,0	200,0	0,5	6,0	5,0	LC..1606..
Steadyline®	CFIL2525X06L100070-JETI	03244881	70,0	100,0	25	25	131	47	26,5	24,95	18,0	200,0	0,1	6,0	5,0	LC..1606..
	CFIL2525X06L130090-JETI	03244914	90,0	130,0	25	25	131	47	26,5	24,95	18,0	200,0	0,7	6,0	5,0	LC..1606..
	CFIL2525X06L170110-JETI	03244814	110,0	170,0	25	25	131	47	26,5	24,95	18,0	200,0	0,4	6,0	5,0	LC..1606..
	CFIL2525X06L230140-JETI	03244894	140,0	230,0	25	25	131	47	26,5	24,95	18,0	200,0	0,6	6,0	5,0	LC..1606..

Spare Parts

MDT	For size	Clamp key	Clamp screw	Plug	Plug screw
					
Mini-Shaft™	CFIR/L...-03	4SMS795	TCEI0513	JET-P1/8-5MM	P6SS6X6
	CFIR/L...-04	5SMS795	TCEI0613	JET-P1/8-5MM	P6SS6X6
	CFIR/L...-05	5SMS795	TCEI0613	JET-P1/8-5MM	P6SS6X6
	CFIR/L...-06	6SMS795	TCEI0815	JET-P1/8-5MM	P6SS6X6

Grooving

Parting-off

X4

Adapters
Clamping units

Accessories and
Spare parts

Workpiece
materials

CFIR...R...JET, CFIL...L...JET – Toolholders for inserts LCGF, LCGN, LCMF and LCMR – Metric

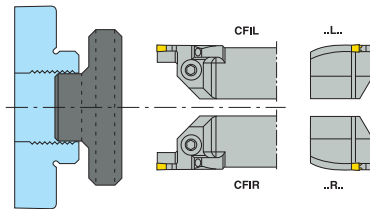
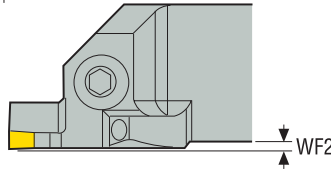
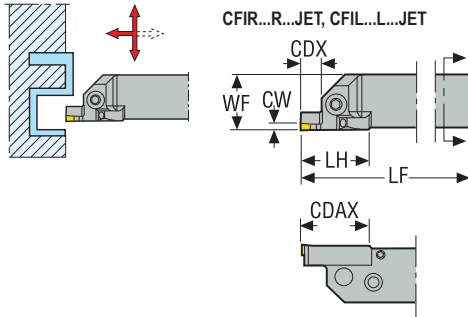

CFIR/L
KAPR = 90,0°



- For inserts program, see page(s) 839, 842-844
- Initial plunge (INPLM/INPLX) relates to face groove diameter, see page(s) 705
- For more information on Jetstream Tooling® (High pressure coolant) and accessories, please see page(s) 38, 85-89, 1002
- CTWS = Insert shape and size
- *** Max coolant pressure using hose connection
- CDX = 3 x CW
- Right-hand version with right-hand blade shown
- Please check availability at www.secotools.com / Seco Online Store

Designation	Item number	INPLM	INPLX	H	B	LF	WF	WF2	LH	CDX**	CP***	Weight	CW	TQ	CTWS
		mm	mm	mm	mm	mm	mm	mm	mm	mm	bar	kg	mm	Nm	
CFIR3225P08R130090-JET	02703655	90,0	130,0	32	25	170	26,5	1,5	56,0	24,0	275,0	1,0	8,0	10,0	LC..3008..
CFIR3225P08R170110-JET	02703656	110,0	170,0	32	25	170	26,5	1,5	56,0	24,0	275,0	1,0	8,0	10,0	LC..3008..
CFIR3225P08R230140-JET	02703657	140,0	230,0	32	25	170	26,5	1,5	56,0	24,0	275,0	1,0	8,0	10,0	LC..3008..
CFIR3225P08R500200-JET	02703658	200,0	500,0	32	25	170	26,5	1,5	56,0	24,0	275,0	1,0	8,0	10,0	LC..3008..
CFIL3225P08L130090-JET	02703636	90,0	130,0	32	25	170	26,5	1,5	56,0	24,0	275,0	1,0	8,0	10,0	LC..3008..
CFIL3225P08L170110-JET	02703637	110,0	170,0	32	25	170	26,5	1,5	56,0	24,0	275,0	1,0	8,0	10,0	LC..3008..
CFIL3225P08L230140-JET	02703638	140,0	230,0	32	25	170	26,5	1,5	56,0	24,0	275,0	1,0	8,0	10,0	LC..3008..
CFIL3225P08L500200-JET	02703639	200,0	500,0	32	25	170	26,5	1,5	56,0	24,0	275,0	1,0	8,0	10,0	LC..3008..

Spare Parts

For size	Clamp key	Clamp screw	Plug
CFIR/L...-08	 6SMS795	 TCEI1020	 JET-P1/8-5MM

General ISO Turning

Steadyline®

MDT

Mini-Shaft™

Grooving

Parting-off

X4

Adapters
Clamping units

Accessories and
Spare parts

Workpiece
materials

CFIR...R...JET, CFIL...L...JET – Toolholders for inserts LCGF, LCGN, LCMF and LCMR – Inch



CFIR...R...JET, CFIL...L...JET

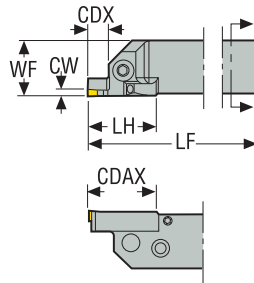

KAPR = 90,0 °

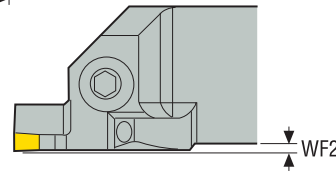
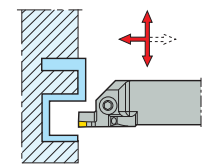

CTWS



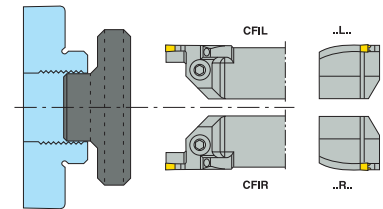

- For inserts program, see page(s) 839, 842-844
- Initial plunge (INPLM/INPLX) relates to face groove diameter, see page(s) 705
- For more information on Jetstream Tooling® (High pressure coolant) and accessories, please see page(s) 38, 85-89, 1002
- CTWS = Insert shape and size
- *** Max coolant pressure using hose connection
- CDX = 3 x CW
- Right-hand version with right-hand blade shown
- Please check availability at www.secotools.com / Seco Online Store



Designation	Item number	INPLM	INPLX	H	B	LF	WF	WF2	LH	CDX**	CP***	Weight	CW	TQ	CTWS
CFIR10003D-R3.102.17-JET	02718999	2.165	3.150	1.000	1.000	6.000	1.043	0.059	1.299	0.354	3988.5	1.540	0.118	53.1	LC..1603..
CFIR10003D-R4.002.75-JET	02703515	2.756	3.937	1.000	1.000	6.000	1.043	0.059	1.299	0.354	3988.5	1.540	0.118	53.1	LC..1603..
CFIR10003D-R5.003.50-JET	02703516	3.543	5.118	1.000	1.000	6.000	1.043	0.059	1.299	0.354	3988.5	1.540	0.118	53.1	LC..1603..
CFIR10003D-R6.704.30-JET	02703517	4.331	6.693	1.000	1.000	6.000	1.043	0.059	1.299	0.354	3988.5	1.540	0.118	53.1	LC..1603..
CFIL10003D-L3.102.17-JET	02718995	2.165	3.150	1.000	1.000	6.000	1.043	0.059	1.299	0.354	3988.5	1.540	0.118	53.1	LC..1603..
CFIL10003D-L4.002.75-JET	02703496	2.756	3.937	1.000	1.000	6.000	1.043	0.059	1.299	0.354	3988.5	1.540	0.118	53.1	LC..1603..
CFIL10003D-L5.003.50-JET	02703497	3.543	5.118	1.000	1.000	6.000	1.043	0.059	1.299	0.354	3988.5	1.540	0.118	53.1	LC..1603..
CFIL10003D-L6.704.30-JET	02703498	4.331	6.693	1.000	1.000	6.000	1.043	0.059	1.299	0.354	3988.5	1.540	0.118	53.1	LC..1603..
CFIR10004D-R3.102.17-JET	02719000	2.165	3.150	1.000	1.000	6.000	1.043	0.059	1.417	0.472	3988.5	1.540	0.157	70.8	LC..1604..
CFIR10004D-R4.002.75-JET	02703518	2.756	3.937	1.000	1.000	6.000	1.043	0.059	1.417	0.472	3988.5	1.540	0.157	70.8	LC..1604..
CFIR10004D-R5.003.50-JET	02703519	3.543	5.118	1.000	1.000	6.000	1.043	0.059	1.417	0.472	3988.5	1.540	0.157	70.8	LC..1604..
CFIR10004D-R6.704.30-JET	02703520	4.331	6.693	1.000	1.000	6.000	1.043	0.059	1.417	0.472	3988.5	1.540	0.157	70.8	LC..1604..
CFIR10004D-R9.005.50-JET	02703521	5.512	9.055	1.000	1.000	6.000	1.043	0.059	1.417	0.472	3988.5	1.540	0.157	70.8	LC..1604..
CFIL10004D-L3.102.17-JET	02718996	2.165	3.150	1.000	1.000	6.000	1.043	0.059	1.417	0.472	3988.5	1.540	0.157	70.8	LC..1604..
CFIL10004D-L4.002.75-JET	02703499	2.756	3.937	1.000	1.000	6.000	1.043	0.059	1.417	0.472	3988.5	1.540	0.157	70.8	LC..1604..
CFIL10004D-L5.003.50-JET	02703500	3.543	5.118	1.000	1.000	6.000	1.043	0.059	1.417	0.472	3988.5	1.540	0.157	70.8	LC..1604..
CFIL10004D-L6.704.30-JET	02703501	4.331	6.693	1.000	1.000	6.000	1.043	0.059	1.417	0.472	3988.5	1.540	0.157	70.8	LC..1604..
CFIL10004D-L9.005.50-JET	02703502	5.512	9.055	1.000	1.000	6.000	1.043	0.059	1.417	0.472	3988.5	1.540	0.157	70.8	LC..1604..
CFIR10005D-R3.102.17-JET	02719001	2.165	3.150	1.000	1.000	6.000	1.043	0.059	1.575	0.591	3988.5	1.760	0.197	70.8	LC..1605..
CFIR10005D-R4.002.75-JET	02703522	2.756	3.937	1.000	1.000	6.000	1.043	0.059	1.575	0.591	3988.5	1.540	0.197	70.8	LC..1605..
CFIR10005D-R5.003.50-JET	02703523	3.543	5.118	1.000	1.000	6.000	1.043	0.059	1.575	0.591	3988.5	1.540	0.197	70.8	LC..1605..
CFIR10005D-R6.704.30-JET	02703524	4.331	6.693	1.000	1.000	6.000	1.043	0.059	1.575	0.591	3988.5	1.540	0.197	70.8	LC..1605..
CFIR10005D-R9.005.50-JET	02703525	5.512	9.055	1.000	1.000	6.000	1.043	0.059	1.575	0.591	3988.5	1.540	0.197	70.8	LC..1605..
CFIL10005D-L3.102.17-JET	02718997	2.165	3.150	1.000	1.000	6.000	1.043	0.059	1.575	0.591	3988.5	1.760	0.197	70.8	LC..1605..
CFIL10005D-L4.002.75-JET	02703503	2.756	3.937	1.000	1.000	6.000	1.043	0.059	1.575	0.591	3988.5	1.540	0.197	70.8	LC..1605..
CFIL10005D-L5.003.50-JET	02703504	3.543	5.118	1.000	1.000	6.000	1.043	0.059	1.575	0.591	3988.5	1.540	0.197	70.8	LC..1605..
CFIL10005D-L6.704.30-JET	02703505	4.331	6.693	1.000	1.000	6.000	1.043	0.059	1.575	0.591	3988.5	1.540	0.197	70.8	LC..1605..
CFIL10005D-L9.005.50-JET	02703506	5.512	9.055	1.000	1.000	6.000	1.043	0.059	1.575	0.591	3988.5	1.540	0.197	70.8	LC..1605..
CFIR10006D-R3.102.17-JET	02719002	2.165	3.150	1.000	1.000	6.000	1.043	0.059	1.811	0.709	3988.5	1.760	0.236	88.5	LC..1606..
CFIR10006D-R4.002.75-JET	02703526	2.756	3.937	1.000	1.000	6.000	1.043	0.059	1.811	0.709	3988.5	1.540	0.236	88.5	LC..1606..

Designation	Item number	INPLM	INPLX	H	B	LF	WF	WF2	LH	CDX**	CP***	Weight	CW	TQ	CTWS
		Inch	Inch	Inch	Inch	Inch	Inch	Inch	Inch	Inch	psi	lbs	Inch	In/Lbs.	
CFIR10006D-R5.003.50-JET	02703527	3.543	5.118	1.000	1.000	6.000	1.043	0.059	1.811	0.709	3988.5	1.540	0.236	88.5	LC..1606..
CFIR10006D-R6.704.30-JET	02703528	4.331	6.693	1.000	1.000	6.000	1.043	0.059	1.811	0.709	3988.5	1.540	0.236	88.5	LC..1606..
CFIR10006D-R9.005.50-JET	02703529	5.512	9.055	1.000	1.000	6.000	1.043	0.059	1.811	0.709	3988.5	1.540	0.236	88.5	LC..1606..
CFIL10006D-L3.102.17-JET	02718998	2.165	3.150	1.000	1.000	6.000	1.043	0.059	1.811	0.709	3988.5	1.760	0.236	88.5	LC..1606..
CFIL10006D-L4.002.75-JET	02703507	2.756	3.937	1.000	1.000	6.000	1.043	0.059	1.811	0.709	3988.5	1.540	0.236	88.5	LC..1606..
CFIL10006D-L5.003.50-JET	02703508	3.543	5.118	1.000	1.000	6.000	1.043	0.059	1.811	0.709	3988.5	1.540	0.236	88.5	LC..1606..
CFIL10006D-L6.704.30-JET	02703509	4.331	6.693	1.000	1.000	6.000	1.043	0.059	1.811	0.709	3988.5	1.540	0.236	88.5	LC..1606..
CFIL10006D-L9.005.50-JET	02703510	5.512	9.055	1.000	1.000	6.000	1.043	0.059	1.811	0.709	3988.5	1.540	0.236	88.5	LC..1606..
CFIR12508E-R5.003.50-JET	02703530	3.543	5.118	1.250	1.250	7.000	1.043	0.059	2.205	0.945	3988.5	2.650	0.315	132.8	LC..3008..
CFIR12508E-R6.704.30-JET	02703531	4.331	6.693	1.250	1.250	7.000	1.043	0.059	2.205	0.945	3988.5	2.650	0.315	132.8	LC..3008..
CFIR12508E-R9.005.50-JET	02703532	5.512	9.055	1.250	1.250	7.000	1.043	0.059	2.205	0.945	3988.5	2.870	0.315	132.8	LC..3008..
CFIR12508E-R19.78.00-JET	02703533	7.874	19.685	1.250	1.250	7.000	1.043	0.059	2.205	0.945	3988.5	2.650	0.315	132.8	LC..3008..
CFIL12508E-L5.003.50-JET	02703511	3.543	5.118	1.250	1.250	7.000	1.043	0.059	2.205	0.945	3988.5	2.650	0.315	132.8	LC..3008..
CFIL12508E-L6.704.30-JET	02703512	4.331	6.693	1.250	1.250	7.000	1.043	0.059	2.205	0.945	3988.5	2.650	0.315	132.8	LC..3008..
CFIL12508E-L9.005.50-JET	02703513	5.512	9.055	1.250	1.250	7.000	1.043	0.059	2.205	0.945	3988.5	2.870	0.315	132.8	LC..3008..
CFIL12508E-L19.78.00-JET	02765806	7.874	19.685	1.250	1.250	7.000	1.043	0.059	2.205	0.945	3988.5	2.650	0.315	132.8	LC..3008..
CFIL12508E-R19.78.00-JET	02703514	7.874	19.685	1.000	1.000	7.000	1.315	-	2.205	0.945	3988.5	2.870	0.315	132.8	LC..3008..

Spare Parts

For size	Clamp key	Clamp screw	Plug
			
CFIR/L..-03	4SMS795	TCEI0513	JET-P1/8-5MM
CFIR/L..-04	5SMS795	TCEI0613	JET-P1/8-5MM
CFIR/L..-05	5SMS795	TCEI0613	JET-P1/8-5MM
CFIR/L..-06	6SMS795	TCEI0815	JET-P1/8-5MM
CFIR/L..-08	6SMS795	TCEI1020	JET-P1/8-5MM

General ISO Turning

Steadyline®

MDT

Mini-Shaft™

Grooving

Parting-off

X4

Adapters
Clamping units

Accessories and
Spare parts

Workpiece
materials

General ISO Turning

Steadyline®

MDT

Mini-Shaft™

Grooving

Parting-off

X4

Adapters
Clamping units

Accessories and
Spare parts

Workpiece
materials

CFOR...L...JETI, CFOL...R...JETI – Toolholders compatible with JETI adapters for inserts LCGF, LCGN, LCMF and LCMR – Metric



CFOR...L...JETI, CFOL...R...JETI

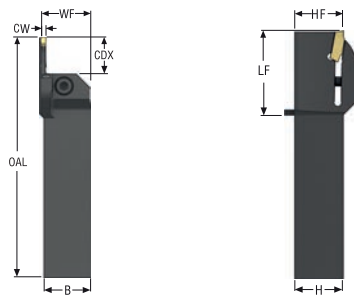

CFOR/L
KAPR = 90,0 °

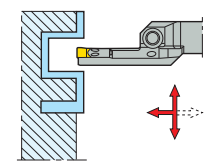

CTWS



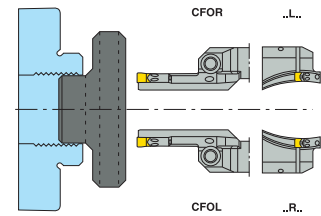

- For inserts program, see page(s) 839-844, 854-855
- For suitable adapter, see page(s) 962-973
- For more information on Jetstream Tooling® (High pressure coolant) and accessories, please see page(s) 38, 85-89, 1002
- Initial plunge (INPLM/INPLX) relates to face groove diameter, see page(s) 705
- CTWS = Insert shape and size
- ** Max depth of cut for LCGF/LCMF16.. = 14 mm
- *** Max coolant pressure. When using toolholder together with an adapter the maximum coolant pressure might be limited, please see page(s) 85
- CDX = 6 x CW
- Right-hand version with left-hand blade shown
- Please check availability at www.secotools.com / Seco Online Store



Designation	Item number	INPLM	INPLX	H	B	OAL	LF	WF	HF	CDX**	CP***	Weight	CW	TQ	CTWS
		mm	mm	mm	mm	mm	mm	mm	mm	mm	bar	kg	mm	Nm	
CFOR2525X03L080055-JETI	03244830	55,0	80,0	25	25	127	43	26,5	24,95	18,0	200,0	0,5	3,0	5,0	LC..1603..
CFOR2525X03L100070-JETI	03244817	70,0	100,0	25	25	127	43	26,5	24,95	18,0	200,0	0,5	3,0	5,0	LC..1603..
CFOR2525X03L130090-JETI	03244778	90,0	130,0	25	25	127	43	26,5	24,95	18,0	200,0	0,5	3,0	5,0	LC..1603..
CFOR2525X03L170110-JETI	03244818	110,0	170,0	25	25	127	43	26,5	24,95	18,0	200,0	0,6	3,0	5,0	LC..1603..
CFOR2525X03L230140-JETI	03244856	140,0	230,0	25	25	127	43	26,5	24,95	18,0	200,0	0,5	3,0	5,0	LC..1603..
CFOR2525X03L500200-JETI	03244779	200,0	500,0	25	25	127	43	26,5	24,95	18,0	200,0	0,5	3,0	5,0	LC..1603..
CFOL2525X03R080055-JETI	03244869	55,0	80,0	25	25	127	43	26,5	24,95	18,0	200,0	0,1	3,0	5,0	LC..1603..
CFOL2525X03R100070-JETI	03244824	70,0	100,0	25	25	127	43	26,5	24,95	18,0	200,0	0,1	3,0	5,0	LC..1603..
CFOL2525X03R130090-JETI	03244815	90,0	130,0	25	25	127	43	26,5	24,95	18,0	200,0	0,6	3,0	5,0	LC..1603..
CFOL2525X03R170110-JETI	03244896	110,0	170,0	25	25	127	43	26,5	24,95	18,0	200,0	0,1	3,0	5,0	LC..1603..
CFOL2525X03R230140-JETI	03244765	140,0	230,0	25	25	127	43	26,5	24,95	18,0	200,0	0,6	3,0	5,0	LC..1603..
CFOL2525X03R500200-JETI	03244753	200,0	500,0	25	25	127	43	26,5	24,95	18,0	200,0	0,5	3,0	5,0	LC..1603..
CFOR2525X04L080055-JETI	03244755	55,0	80,0	25	25	135	51	26,5	24,95	24,0	200,0	0,6	4,0	5,0	LC..1604..
CFOR2525X04L100070-JETI	03244756	70,0	100,0	25	25	135	51	26,5	24,95	24,0	200,0	0,6	4,0	5,0	LC..1604..
CFOR2525X04L130090-JETI	03244795	90,0	130,0	25	25	135	51	26,5	24,95	24,0	200,0	0,6	4,0	5,0	LC..1604..
CFOR2525X04L170110-JETI	03244875	110,0	170,0	25	25	135	51	26,5	24,95	24,0	200,0	0,5	4,0	5,0	LC..1604..
CFOR2525X04L230140-JETI	03244770	140,0	230,0	25	25	135	51	26,5	24,95	24,0	200,0	0,3	4,0	5,0	LC..1604..
CFOR2525X04L500200-JETI	03244754	200,0	500,0	25	25	135	51	26,5	24,95	24,0	200,0	0,6	4,0	5,0	LC..1604..
CFOL2525X04R080055-JETI	03244816	55,0	80,0	25	25	135	51	26,5	24,95	24,0	200,0	0,1	4,0	5,0	LC..1604..
CFOL2525X04R100070-JETI	03244772	70,0	100,0	25	25	135	51	26,5	24,95	24,0	200,0	0,6	4,0	5,0	LC..1604..
CFOL2525X04R130090-JETI	03244777	90,0	130,0	25	25	135	51	26,5	24,95	24,0	200,0	0,6	4,0	5,0	LC..1604..
CFOL2525X04R170110-JETI	03244802	110,0	170,0	25	25	135	51	26,5	24,95	24,0	200,0	0,1	4,0	5,0	LC..1604..
CFOL2525X04R230140-JETI	03244826	140,0	230,0	25	25	135	51	26,5	24,95	24,0	200,0	0,5	4,0	5,0	LC..1604..
CFOL2525X04R500200-JETI	03244747	200,0	500,0	25	25	135	51	26,5	24,95	24,0	200,0	0,6	4,0	5,0	LC..1604..
CFOR2525X05L080055-JETI	03244764	55,0	80,0	25	25	143	59	26,5	24,95	30,0	200,0	0,6	5,0	5,0	LC..1605..
CFOR2525X05L100070-JETI	03244923	70,0	100,0	25	25	143	59	26,5	24,95	30,0	200,0	0,1	5,0	5,0	LC..1605..
CFOR2525X05L130090-JETI	03244834	90,0	130,0	25	25	143	59	26,5	24,95	30,0	200,0	0,6	5,0	5,0	LC..1605..
CFOR2525X05L170110-JETI	03244859	110,0	170,0	25	25	143	59	26,5	24,95	30,0	200,0	0,5	5,0	5,0	LC..1605..

Designation	Item number	INPLM	INPLX	H	B	OAL	LF	WF	HF	CDX**	CP***	Weight	CW	TQ	CTWS
		mm	mm	mm	mm	mm	mm	mm	mm	mm	bar	kg	mm	Nm	
CFOR2525X05L230140-JETI	03244797	140,0	230,0	25	25	143	59	26,5	24,95	30,0	200,0	0,6	5,0	5,0	LC..1605..
CFOR2525X05L500200-JETI	03244751	200,0	500,0	25	25	143	59	26,5	24,95	30,0	200,0	0,4	5,0	5,0	LC..1605..
CFOL2525X05R080055-JETI	03244828	55,0	80,0	25	25	143	59	26,5	24,95	30,0	200,0	0,1	5,0	5,0	LC..1605..
CFOL2525X05R100070-JETI	03244899	70,0	100,0	25	25	143	59	26,5	24,95	30,0	200,0	0,1	5,0	5,0	LC..1605..
CFOL2525X05R130090-JETI	03244870	90,0	130,0	25	25	143	59	26,5	24,95	30,0	200,0	0,1	5,0	5,0	LC..1605..
CFOL2525X05R170110-JETI	03244871	110,0	170,0	25	25	143	59	26,5	24,95	30,0	200,0	0,1	5,0	5,0	LC..1605..
CFOL2525X05R230140-JETI	03244853	140,0	230,0	25	25	143	59	26,5	24,95	30,0	200,0	0,1	5,0	5,0	LC..1605..
CFOL2525X05R500200-JETI	03244748	200,0	500,0	25	25	143	59	26,5	24,95	30,0	200,0	0,6	5,0	5,0	LC..1605..
CFOR2525X06L080055-JETI	03244752	55,0	80,0	25	25	154	70	26,5	24,95	36,0	200,0	0,5	6,0	5,0	LC..1606..
CFOR2525X06L100070-JETI	03244780	70,0	100,0	25	25	154	70	26,5	24,95	36,0	200,0	0,7	6,0	5,0	LC..1606..
CFOR2525X06L130090-JETI	03244760	90,0	130,0	25	25	154	70	26,5	24,95	36,0	200,0	0,6	6,0	5,0	LC..1606..
CFOR2525X06L170110-JETI	03244757	110,0	170,0	25	25	154	70	26,5	24,95	36,0	200,0	0,6	6,0	5,0	LC..1606..
CFOR2525X06L230140-JETI	03244761	140,0	230,0	25	25	154	70	26,5	24,95	36,0	200,0	0,7	6,0	5,0	LC..1606..
CFOR2525X06L500200-JETI	03244762	200,0	500,0	25	25	154	70	26,5	24,95	36,0	200,0	0,6	6,0	5,0	LC..1606..
CFOL2525X06R080055-JETI	03244900	55,0	80,0	25	25	154	70	26,5	24,95	36,0	200,0	0,1	6,0	5,0	LC..1606..
CFOL2525X06R100070-JETI	03244804	70,0	100,0	25	25	154	70	26,5	24,95	36,0	200,0	0,6	6,0	5,0	LC..1606..
CFOL2525X06R130090-JETI	03244829	90,0	130,0	25	25	154	70	26,5	24,95	36,0	200,0	0,6	6,0	5,0	LC..1606..
CFOL2525X06R170110-JETI	03244805	110,0	170,0	25	25	154	70	26,5	24,95	36,0	200,0	0,5	6,0	5,0	LC..1606..
CFOL2525X06R230140-JETI	03244774	140,0	230,0	25	25	154	70	26,5	24,95	36,0	200,0	0,6	6,0	5,0	LC..1606..
CFOL2525X06R500200-JETI	03244749	200,0	500,0	25	25	154	70	26,5	24,95	36,0	200,0	0,6	6,0	5,0	LC..1606..

Spare Parts

For size	Clamp key	Clamp screw	Plug	Plug screw
				
CFOR/L...-03	4SMS795	TCEI0513	JET-P1/8-5MM	P6SS6X6
CFOR/L...-04	5SMS795	TCEI0613	JET-P1/8-5MM	P6SS6X6
CFOR/L...-05	5SMS795	TCEI0613	JET-P1/8-5MM	P6SS6X6
CFOR/L...-06	6SMS795	TCEI0815	JET-P1/8-5MM	P6SS6X6

General ISO Turning

Steadyline®

MDT

Mini-Shaft™

Grooving

Parting-off

X4

Adapters
Clamping units

Accessories and
Spare parts

Workpiece
materials

CFOR...L...JET, CFOL...R...JET – Toolholders for inserts LCGF, LCGN, LCMF and LCMR – Metric

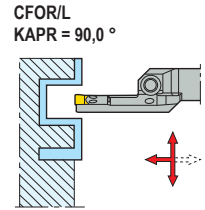
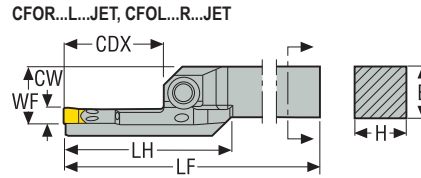

CTWS



- For inserts program, see page(s) 839, 842-844
- Initial plunge (INPLM/INPLX) relates to face groove diameter, see page(s) 705
- For more information on Jetstream Tooling® (High pressure coolant) and accessories, please see page(s) 38, 85-89, 1002
- CTWS = Insert shape and size
- ** Max depth of cut for LCGF/LCMF30.. = 28 mm
- *** Max coolant pressure using hose connection
- CDX = 6 x CW
- Right-hand version with left-hand blade shown
- Please check availability at www.secotools.com / Seco Online Store

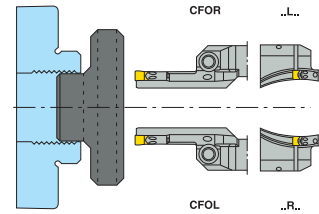

Designation	Item number	INPLM	INPLX	H	B	LF	WF	LH	CDX**	CP***	Weight	CW	TQ	CTWS
		mm	mm	mm	mm	mm	mm	mm	mm	bar	kg	mm	Nm	
CFOR3225P08L130090-JET	02703569	90,0	130,0	32	25	170	28,0	83,0	48,0	275,0	0,9	8,0	10,0	LC..3008..
CFOR3225P08L170110-JET	02703570	110,0	170,0	32	25	170	28,0	83,0	48,0	275,0	0,9	8,0	10,0	LC..3008..
CFOR3225P08L230140-JET	02703571	140,0	230,0	32	25	170	28,0	83,0	48,0	275,0	0,9	8,0	10,0	LC..3008..
CFOR3225P08L500200-JET	02703572	200,0	500,0	32	25	170	28,0	83,0	48,0	275,0	0,9	8,0	10,0	LC..3008..
CFOL3225P08R130090-JET	02703548	90,0	130,0	32	25	170	28,0	83,0	48,0	275,0	0,9	8,0	10,0	LC..3008..
CFOL3225P08R170110-JET	02703549	110,0	170,0	32	25	170	28,0	83,0	48,0	275,0	0,9	8,0	10,0	LC..3008..
CFOL3225P08R230140-JET	02703550	140,0	230,0	32	25	170	28,0	83,0	48,0	275,0	0,9	8,0	10,0	LC..3008..
CFOL3225P08R500200-JET	02703551	200,0	500,0	32	25	170	28,0	83,0	48,0	275,0	0,9	8,0	10,0	LC..3008..

Spare Parts

For size	Clamp key	Clamp screw	Plug
CFOR/L...-08	6SMS795	TCEI1020	JET-P1/8-5MM

General ISO Turning
Steadyline®
MDT
Mini-Shaft™
Grooving
Parting-off
X4
Adapters Clamping units
Accessories and Spare parts
Workpiece materials

CFOR...L...JET, CFOL...R...JET – Toolholders for inserts LCGF, LCGN, LCMF and LCMR – Inch

KAPR = 90,0°

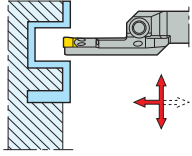

CFOR...L...JET, CFOL...R...JET

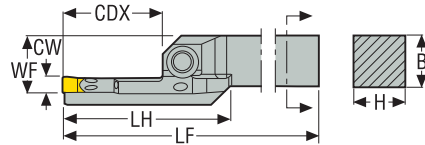

CTWS

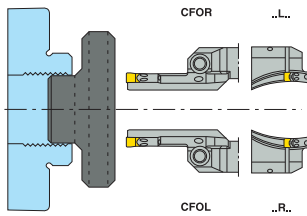

- For inserts program, see page(s) 839, 842-844
- Initial plunge (INPLM/INPLX) relates to face groove diameter, see page(s) 705
- For more information on Jetstream Tooling® (High pressure coolant) and accessories, please see page(s) 38, 85-89, 1002
- CTWS = Insert shape and size
- ** Max depth of cut for double-sided LCGF/LCMF16.. = 0.551 inch, LCGF/LCMF30.. = 1.102 inch
- *** Max coolant pressure using hose connection
- CDX = 6 x CW
- Right-hand version with left-hand blade shown
- Please check availability at www.secotools.com / Seco Online Store

Designation	Item number	INPLM	INPLX	H	B	LF	WF	LH	CDX**	CP***	Weight	CW	TQ	CTWS
		Inch	Inch	Inch	Inch	Inch	Inch	Inch	Inch	psi	lbs	Inch	In/Lbs.	
CFOR10003D-L3.102.17-JET	02718991	2.165	3.150	1.000	1.000	6.000	1.043	1.693	0.748	3988.5	1.760	0.118	53.1	LC..1603..
CFOR10003D-L4.002.75-JET	02703429	2.756	3.937	1.000	1.000	6.000	1.043	1.693	0.748	3988.5	1.540	0.118	53.1	LC..1603..
CFOR10003D-L5.003.50-JET	02703430	3.543	5.118	1.000	1.000	6.000	1.043	1.693	0.748	3988.5	1.540	0.118	53.1	LC..1603..
CFOR10003D-L6.704.30-JET	02703431	4.331	6.693	1.000	1.000	6.000	1.043	1.693	0.748	3988.5	1.540	0.118	53.1	LC..1603..
CFOR10003D-L9.005.50-JET	02703384	5.512	9.055	1.000	1.000	6.000	1.043	1.693	0.748	3988.5	1.760	0.118	53.1	LC..1603..
CFOR10003D-L19.78.00-JET	02703385	7.874	19.685	1.000	1.000	6.000	1.043	1.693	0.748	3988.5	1.760	0.118	53.1	LC..1603..
CFOL10003D-R3.102.17-JET	02718987	2.165	3.150	1.000	1.000	6.000	1.043	1.693	0.748	3988.5	1.760	0.118	53.1	LC..1603..
CFOL10003D-R4.002.75-JET	02701848	2.756	3.937	1.000	1.000	6.000	1.043	1.693	0.748	3988.5	1.540	0.118	53.1	LC..1603..
CFOL10003D-R5.003.50-JET	02703411	3.543	5.118	1.000	1.000	6.000	1.043	1.693	0.748	3988.5	1.540	0.118	53.1	LC..1603..
CFOL10003D-R6.704.30-JET	02703412	4.331	6.693	1.000	1.000	6.000	1.043	1.693	0.748	3988.5	1.540	0.118	53.1	LC..1603..
CFOL10003D-R9.005.50-JET	02703280	5.512	9.055	1.000	1.000	6.000	1.043	1.693	0.748	3988.5	1.760	0.118	53.1	LC..1603..
CFOL10003D-R19.78.00-JET	02703379	7.874	19.685	1.000	1.000	6.000	1.043	1.693	0.748	3988.5	1.760	0.118	53.1	LC..1603..
CFOR10004D-L3.102.17-JET	02718992	2.165	3.150	1.000	1.000	6.000	1.043	2.008	0.945	3988.5	1.760	0.157	70.8	LC..1604..
CFOR10004D-L4.002.75-JET	02703432	2.756	3.937	1.000	1.000	6.000	1.043	2.008	0.945	3988.5	1.540	0.157	70.8	LC..1604..
CFOR10004D-L5.003.50-JET	02703433	3.543	5.118	1.000	1.000	6.000	1.043	2.008	0.945	3988.5	1.540	0.157	70.8	LC..1604..
CFOR10004D-L6.704.30-JET	02703434	4.331	6.693	1.000	1.000	6.000	1.043	2.008	0.945	3988.5	1.540	0.157	70.8	LC..1604..
CFOR10004D-L9.005.50-JET	02703435	5.512	9.055	1.000	1.000	6.000	1.043	2.008	0.945	3988.5	1.540	0.157	70.8	LC..1604..
CFOR10004D-L19.78.00-JET	02703386	7.874	19.685	1.000	1.000	6.000	1.043	2.008	0.945	3988.5	1.760	0.157	70.8	LC..1604..
CFOL10004D-R3.102.17-JET	02718988	2.165	3.150	1.000	1.000	6.000	1.043	2.008	0.945	3988.5	1.760	0.157	70.8	LC..1604..
CFOL10004D-R4.002.75-JET	02703413	2.756	3.937	1.000	1.000	6.000	1.043	2.008	0.945	3988.5	1.540	0.157	70.8	LC..1604..
CFOL10004D-R5.003.50-JET	02703414	3.543	5.118	1.000	1.000	6.000	1.043	2.008	0.945	3988.5	1.540	0.157	70.8	LC..1604..
CFOL10004D-R6.704.30-JET	02703415	4.331	6.693	1.000	1.000	6.000	1.043	2.008	0.945	3988.5	1.540	0.157	70.8	LC..1604..
CFOL10004D-R9.005.50-JET	02703416	5.512	9.055	1.000	1.000	6.000	1.043	2.008	0.945	3988.5	1.540	0.157	70.8	LC..1604..
CFOL10004D-R19.78.00-JET	02703381	7.874	19.685	1.000	1.000	6.000	1.043	2.008	0.945	3988.5	1.760	0.157	70.8	LC..1604..
CFOR10005D-L3.102.17-JET	02718993	2.165	3.150	1.000	1.000	6.000	1.043	2.299	1.122	3988.5	1.760	0.197	70.8	LC..1605..
CFOR10005D-L4.002.75-JET	02703436	2.756	3.937	1.000	1.000	6.000	1.043	2.299	1.122	3988.5	1.540	0.197	70.8	LC..1605..
CFOR10005D-L5.003.50-JET	02703437	3.543	5.118	1.000	1.000	6.000	1.043	2.299	1.122	3988.5	1.540	0.197	70.8	LC..1605..
CFOR10005D-L6.704.30-JET	02703438	4.331	6.693	1.000	1.000	6.000	1.043	2.299	1.122	3988.5	1.540	0.197	70.8	LC..1605..
CFOR10005D-L9.005.50-JET	02703439	5.512	9.055	1.000	1.000	6.000	1.043	2.299	1.122	3988.5	1.540	0.197	70.8	LC..1605..
CFOR10005D-L19.78.00-JET	02703387	7.874	19.685	1.000	1.000	6.000	1.043	2.299	1.122	3988.5	1.540	0.197	70.8	LC..1605..

General ISO Turning

Steadyline®

MDT

Mini-Shaft™

Grooving

Parting-off

X4

Adapters
Clamping units

Accessories and
Spare parts

Workpiece
materials

	Designation	Item number	INPLM	INPLX	H	B	LF	WF	LH	CDX**	CP***	Weight	CW	TQ	CTWS
			Inch	Inch	Inch	Inch	Inch	Inch	Inch	Inch	Inch	psi	lbs	Inch	In/Lbs.
General ISO Turning	CFOL10005D-R3.102.17-JET	02718989	2.165	3.150	1.000	1.000	6.000	1.043	2.299	1.122	3988.5	1.760	0.197	70.8	LC..1605..
	CFOL10005D-R4.002.75-JET	02703417	2.756	3.937	1.000	1.000	6.000	1.043	2.299	1.122	3988.5	1.540	0.197	70.8	LC..1605..
	CFOL10005D-R5.003.50-JET	02703418	3.543	5.118	1.000	1.000	6.000	1.043	2.299	1.122	3988.5	1.540	0.197	70.8	LC..1605..
	CFOL10005D-R6.704.30-JET	02703419	4.331	6.693	1.000	1.000	6.000	1.043	2.299	1.122	3988.5	1.540	0.197	70.8	LC..1605..
	CFOL10005D-R9.005.50-JET	02703420	5.512	9.055	1.000	1.000	6.000	1.043	2.299	1.122	3988.5	1.540	0.197	70.8	LC..1605..
Steadyline®	CFOL10005D-R19.78.00-JET	02703382	7.874	19.685	1.000	1.000	6.000	1.043	2.299	1.122	3988.5	1.540	0.197	70.8	LC..1605..
	CFOR10006D-L3.102.17-JET	02718994	2.165	3.150	1.000	1.000	6.000	1.043	2.811	1.496	3988.5	1.540	0.236	88.5	LC..1606..
	CFOR10006D-L4.002.75-JET	02703440	2.756	3.937	1.000	1.000	6.000	1.043	2.811	1.496	3988.5	1.540	0.236	88.5	LC..1606..
	CFOR10006D-L5.003.50-JET	02703441	3.543	5.118	1.000	1.000	6.000	1.043	2.811	1.496	3988.5	1.540	0.236	88.5	LC..1606..
	CFOR10006D-L6.704.30-JET	02703442	4.331	6.693	1.000	1.000	6.000	1.043	2.811	1.496	3988.5	1.540	0.236	88.5	LC..1606..
MDT	CFOR10006D-L19.78.00-JET	02703388	7.874	19.685	1.000	1.000	6.000	1.043	2.811	1.496	3988.5	1.760	0.236	88.5	LC..1606..
	CFOL10006D-R19.78.00-JET	02703383	7.874	19.685	1.000	1.000	6.000	1.043	2.811	1.496	3988.5	1.760	0.236	88.5	LC..1606..
	CFOL10006D-R3.102.17-JET	02718990	2.165	3.150	1.000	1.000	6.000	1.043	2.811	1.496	3988.5	1.540	0.236	88.5	LC..1606..
	CFOL10006D-R4.002.75-JET	02703421	2.756	3.937	1.000	1.000	6.000	1.043	2.811	1.496	3988.5	1.540	0.236	88.5	LC..1606..
	CFOL10006D-R5.003.50-JET	02703422	3.543	5.118	1.000	1.000	6.000	1.043	2.811	1.496	3988.5	1.540	0.236	88.5	LC..1606..
Mini-Shaft™	CFOL10006D-R6.704.30-JET	02703423	4.331	6.693	1.000	1.000	6.000	1.043	2.811	1.496	3988.5	1.540	0.236	88.5	LC..1606..
	CFOL10006D-R9.005.50-JET	02703424	5.512	9.055	1.000	1.000	6.000	1.043	2.811	1.496	3988.5	1.540	0.236	88.5	LC..1606..
	CFOR10006D-L9.005.50-JET	02703443	5.512	9.055	1.000	1.000	6.000	1.043	2.811	1.496	3988.5	1.540	0.236	88.5	LC..1606..
	CFOR12508E-L5.003.50-JET	02703444	3.543	5.118	1.250	1.250	7.000	1.315	3.268	1.890	3988.5	2.650	0.315	132.8	LC..3008..
	CFOR12508E-L6.704.30-JET	02703445	4.331	6.693	1.250	1.250	7.000	1.315	3.268	1.890	3988.5	2.650	0.315	132.8	LC..3008..
Grooving	CFOR12508E-L9.005.50-JET	02703446	5.512	9.055	1.250	1.250	7.000	1.315	3.268	1.890	3988.5	2.430	0.315	132.8	LC..3008..
	CFOR12508E-L19.78.00-JET	02703447	7.874	19.685	1.250	1.250	7.000	1.315	3.268	1.890	3988.5	2.430	0.315	132.8	LC..3008..
	CFOL12508E-R5.003.50-JET	02703425	3.543	5.118	1.250	1.250	7.000	1.315	3.268	1.890	3988.5	2.650	0.315	132.8	LC..3008..
	CFOL12508E-R6.704.30-JET	02703426	4.331	6.693	1.250	1.250	7.000	1.315	3.268	1.890	3988.5	2.650	0.315	132.8	LC..3008..
	CFOL12508E-R9.005.50-JET	02703427	5.512	9.055	1.250	1.250	7.000	1.315	3.268	1.890	3988.5	2.430	0.315	132.8	LC..3008..
CFOL12508E-R19.78.00-JET	02703428	7.874	19.685	1.250	1.250	7.000	1.315	3.268	1.890	3988.5	2.430	0.315	132.8	LC..3008..	

Spare Parts

For size	Clamp key	Clamp screw	Plug
			
CFOR/L..-03	4SMS795	TCEI0513	JET-P1/8-5MM
CFOR/L..-04	5SMS795	TCEI0613	JET-P1/8-5MM
CFOR/L..-05	5SMS795	TCEI0613	JET-P1/8-5MM
CFOR/L..-06	6SMS795	TCEI0815	JET-P1/8-5MM
CFOR/L..-08	6SMS795	TCEI1020	JET-P1/8-5MM

Parting-off
X4
Adapters
Clamping units
Accessories and
Spare parts
Workpiece
materials

CFOR...R...JETI, CFOL...L...JETI – Toolholders compatible with JETI adapters for inserts LCGF, LCGN, LCMF and LCMR – Metric

CFOR/L
KAPR = 90,0°

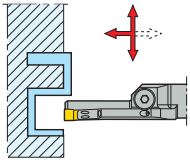

CFOR...R...JETI, CFOL...L...JETI

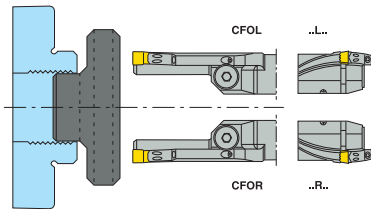
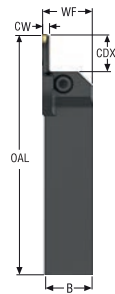

- For inserts program, see page(s) 839-844, 854-855
- For suitable adapter, see page(s) 962-973
- For more information on Jetstream Tooling® (High pressure coolant) and accessories, please see page(s) 38, 85-89, 1002
- Initial plunge (INPLM/INPLX) relates to face groove diameter, see page(s) 705
- CTWS = Insert shape and size
- ** Max depth of cut for LCGF/LCMF16.. = 14 mm
- *** Max coolant pressure. When using toolholder together with an adapter the maximum coolant pressure might be limited, please see page(s) 85
- CDX = 6 x CW
- Right-hand version with right-hand blade shown
- Please check availability at www.secotools.com / Seco Online Store

Designation	Item number	INPLM	INPLX	H	B	OAL	LF	WF	HF	CDX**	CP***	Weight	CW	TQ	CTWS
		mm	mm												
CFOR2525X03R080055-JETI	03244831	55,0	80,0	25	25	127	43	26,5	24,95	18,0	200,0	0,1	3,0	5,0	LC..1603..
CFOR2525X03R100070-JETI	03244873	70,0	100,0	25	25	127	43	26,5	24,95	18,0	200,0	0,1	3,0	5,0	LC..1603..
CFOR2525X03R130090-JETI	03244832	90,0	130,0	25	25	127	43	26,5	24,95	18,0	200,0	0,1	3,0	5,0	LC..1603..
CFOR2525X03R170110-JETI	03244833	110,0	170,0	25	25	127	43	26,5	24,95	18,0	200,0	0,6	3,0	5,0	LC..1603..
CFOR2525X03R230140-JETI	03244874	140,0	230,0	25	25	127	43	26,5	24,95	18,0	200,0	0,1	3,0	5,0	LC..1603..
CFOR2525X03R500200-JETI	03244794	200,0	500,0	25	25	127	43	26,5	24,95	18,0	200,0	0,5	3,0	5,0	LC..1603..
CFOL2525X03L080055-JETI	03244865	55,0	80,0	25	25	127	43	26,5	24,95	18,0	200,0	0,1	3,0	5,0	LC..1603..
CFOL2525X03L100070-JETI	03244907	70,0	100,0	25	25	127	43	26,5	24,95	18,0	200,0	0,1	3,0	5,0	LC..1603..
CFOL2525X03L130090-JETI	03244866	90,0	130,0	25	25	127	43	26,5	24,95	18,0	200,0	0,5	3,0	5,0	LC..1603..
CFOL2525X03L170110-JETI	03244908	110,0	170,0	25	25	127	43	26,5	24,95	18,0	200,0	0,1	3,0	5,0	LC..1603..
CFOL2525X03L230140-JETI	03244867	140,0	230,0	25	25	127	43	26,5	24,95	18,0	200,0	0,5	3,0	5,0	LC..1603..
CFOL2525X03L500200-JETI	03244895	200,0	500,0	25	25	127	43	26,5	24,95	18,0	200,0	0,5	3,0	5,0	LC..1603..
CFOR2525X04R080055-JETI	03244796	55,0	80,0	25	25	135	51	26,5	24,95	24,0	200,0	0,6	4,0	5,0	LC..1604..
CFOR2525X04R100070-JETI	03244857	70,0	100,0	25	25	135	51	26,5	24,95	24,0	200,0	0,5	4,0	5,0	LC..1604..
CFOR2525X04R130090-JETI	03244768	90,0	130,0	25	25	135	51	26,5	24,95	24,0	200,0	0,5	4,0	5,0	LC..1604..
CFOR2525X04R170110-JETI	03244819	110,0	170,0	25	25	135	51	26,5	24,95	24,0	200,0	0,5	4,0	5,0	LC..1604..
CFOR2525X04R230140-JETI	03244858	140,0	230,0	25	25	135	51	26,5	24,95	24,0	200,0	0,1	4,0	5,0	LC..1604..
CFOR2525X04R500200-JETI	03244763	200,0	500,0	25	25	135	51	26,5	24,95	24,0	200,0	0,6	4,0	5,0	LC..1604..
CFOL2525X04L080055-JETI	03244897	55,0	80,0	25	25	135	51	26,5	24,95	24,0	200,0	0,1	4,0	5,0	LC..1604..
CFOL2525X04L100070-JETI	03244851	70,0	100,0	25	25	135	51	26,5	24,95	24,0	200,0	0,1	4,0	5,0	LC..1604..
CFOL2525X04L130090-JETI	03244800	90,0	130,0	25	25	135	51	26,5	24,95	24,0	200,0	0,1	4,0	5,0	LC..1604..
CFOL2525X04L170110-JETI	03244825	110,0	170,0	25	25	135	51	26,5	24,95	24,0	200,0	0,1	4,0	5,0	LC..1604..
CFOL2525X04L230140-JETI	03244852	140,0	230,0	25	25	135	51	26,5	24,95	24,0	200,0	0,6	4,0	5,0	LC..1604..
CFOL2525X04L500200-JETI	03244801	200,0	500,0	25	25	135	51	26,5	24,95	24,0	200,0	0,6	4,0	5,0	LC..1604..
CFOR2525X05R080055-JETI	03244775	80,0	55,0	25	25	143	59	26,5	24,95	30,0	200,0	0,7	5,0	5,0	LC..1605..
CFOR2525X05R100070-JETI	03244860	70,0	100,0	25	25	143	59	26,5	24,95	30,0	200,0	0,1	5,0	5,0	LC..1605..
CFOR2525X05R130090-JETI	03244901	90,0	130,0	25	25	143	59	26,5	24,95	30,0	200,0	0,5	5,0	5,0	LC..1605..
CFOR2525X05R170110-JETI	03244820	110,0	170,0	25	25	143	59	26,5	24,95	30,0	200,0	0,1	5,0	5,0	LC..1605..

General ISO Turning

Steadyline®

MDT

Mini-Shaft™

Grooving

Parting-off

X4





Adapters
Clamping units

Accessories and
Spare parts

Workpiece
materials

	Designation	Item number	INPLM	INPLX	H	B	OAL	LF	WF	HF	CDX**	CP***	Weight	CW	TQ	CTWS
			mm	mm	mm	mm	mm	mm	mm	mm	mm	mm	bar	kg	mm	Nm
General ISO Turning	CFOR2525X05R230140-JETI	03244861	140,0	230,0	25	25	143	59	26,5	24,95	30,0	200,0	0,6	5,0	5,0	LC..1605..
	CFOR2525X05R500200-JETI	03244771	200,0	500,0	25	25	143	59	26,5	24,95	30,0	200,0	0,6	5,0	5,0	LC..1605..
	CFOL2525X05L080055-JETI	03244773	80,0	55,0	25	25	143	59	26,5	24,95	30,0	200,0	0,6	5,0	5,0	LC..1605..
	CFOL2525X05L100070-JETI	03244909	70,0	100,0	25	25	143	59	26,5	24,95	30,0	200,0	0,1	5,0	5,0	LC..1605..
	CFOL2525X05L130090-JETI	03244767	90,0	130,0	25	25	143	59	26,5	24,95	30,0	200,0	0,5	5,0	5,0	LC..1605..
Steadyline®	CFOL2525X05L170110-JETI	03244898	110,0	170,0	25	25	143	59	26,5	24,95	30,0	200,0	0,5	5,0	5,0	LC..1605..
	CFOL2525X05L230140-JETI	03244827	140,0	230,0	25	25	143	59	26,5	24,95	30,0	200,0	0,1	5,0	5,0	LC..1605..
	CFOL2525X05L500200-JETI	03244783	200,0	500,0	25	25	143	59	26,5	24,95	30,0	200,0	4,0	5,0	5,0	LC..1605..
	CFOR2525X06R080055-JETI	03244785	55,0	80,0	25	25	154	70	26,5	24,95	36,0	200,0	0,6	6,0	5,0	LC..1606..
	CFOR2525X06R100070-JETI	03244840	70,0	100,0	25	25	154	70	26,5	24,95	36,0	200,0	0,1	6,0	5,0	LC..1606..
MDT	CFOR2525X06R130090-JETI	03244841	90,0	130,0	25	25	154	70	26,5	24,95	36,0	200,0	0,5	6,0	5,0	LC..1606..
	CFOR2525X06R170110-JETI	03244821	110,0	170,0	25	25	154	70	26,5	24,95	36,0	200,0	0,5	6,0	5,0	LC..1606..
	CFOR2525X06R230140-JETI	03244902	140,0	230,0	25	25	154	70	26,5	24,95	36,0	200,0	0,6	6,0	5,0	LC..1606..
	CFOR2525X06R500200-JETI	03244750	200,0	500,0	25	25	154	70	26,5	24,95	36,0	200,0	0,6	6,0	5,0	LC..1606..
	CFOL2525X06L080055-JETI	03244872	55,0	80,0	25	25	154	70	26,5	24,95	36,0	200,0	0,5	6,0	5,0	LC..1606..
Mini-Shaft™	CFOL2525X06L100070-JETI	03244854	70,0	100,0	25	25	154	70	26,5	24,95	36,0	200,0	0,5	6,0	5,0	LC..1606..
	CFOL2525X06L130090-JETI	03244855	90,0	130,0	25	25	154	70	26,5	24,95	36,0	200,0	0,1	6,0	5,0	LC..1606..
	CFOL2525X06L170110-JETI	03244803	110,0	170,0	25	25	154	70	26,5	24,95	36,0	200,0	0,5	6,0	5,0	LC..1606..
	CFOL2525X06L230140-JETI	03244769	140,0	230,0	25	25	154	70	26,5	24,95	36,0	200,0	0,7	6,0	5,0	LC..1606..
	CFOL2525X06L500200-JETI	03244759	200,0	500,0	25	25	154	70	26,5	24,95	36,0	200,0	0,6	6,0	5,0	LC..1606..

Spare Parts

For size	Clamp key	Clamp screw	Plug	Plug screw
				
CFOR/L..-03	4SMS795	TCEI0513	JET-P1/8-5MM	P6SS6X6
CFOR/L..-04	5SMS795	TCEI0613	JET-P1/8-5MM	P6SS6X6
CFOR/L..-05	5SMS795	TCEI0613	JET-P1/8-5MM	P6SS6X6
CFOR/L..-06	6SMS795	TCEI0815	JET-P1/8-5MM	P6SS6X6

- X4
- Adapters
Clamping units
- Accessories and
Spare parts
- Workpiece
materials

CFOR...R...JET, CFOL...L...JET – Toolholders for inserts LCGF, LCGN, LCMF and LCMR – Metric

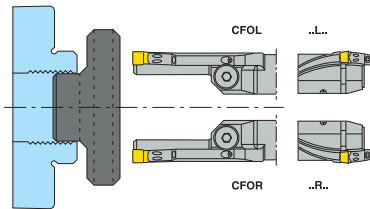
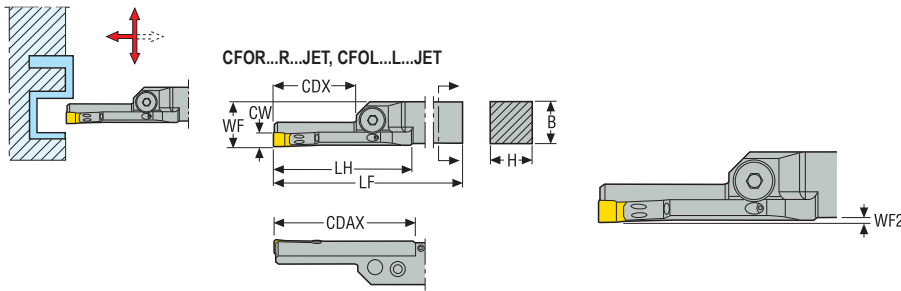

CFOR/L
KAPR = 90,0°



- For inserts program, see page(s) 839, 842-844
- Initial plunge (INPLM/INPLX) relates to face groove diameter, see page(s) 705
- For more information on Jetstream Tooling® (High pressure coolant) and accessories, please see page(s) 38, 85-89, 1002
- CTWS = Insert shape and size
- ** Max depth of cut for LCGF/LCMF30.. = 28 mm
- *** Max coolant pressure using hose connection
- CDX = 6 x CW
- Right-hand version with right-hand blade shown
- Please check availability at www.secotools.com / Seco Online Store

Designation	Item number	INPLM	INPLX	H	B	LF	WF	WF2	LH	CDX**	CP***	Weight	CW	TQ	CTWS
		mm	mm	mm	mm	mm	mm	mm	mm	mm	bar	kg	mm	Nm	
CFOR3225P08R130090-JET	02703617	90,0	130,0	32	25	170	26,5	1,5	83,0	48,0	275,0	0,9	8,0	10,0	LC..3008..
CFOR3225P08R170110-JET	02703618	110,0	170,0	32	25	170	26,5	1,5	83,0	48,0	275,0	0,9	8,0	10,0	LC..3008..
CFOR3225P08R230140-JET	02703619	140,0	230,0	32	25	170	26,5	1,5	83,0	48,0	275,0	0,9	8,0	10,0	LC..3008..
CFOR3225P08R500200-JET	02703620	200,0	500,0	32	25	170	26,5	1,5	83,0	48,0	275,0	0,9	8,0	10,0	LC..3008..
CFOL3225P08L130090-JET	02703593	90,0	130,0	32	25	170	26,5	1,5	83,0	48,0	275,0	0,9	8,0	10,0	LC..3008..
CFOL3225P08L170110-JET	02703594	110,0	170,0	32	25	170	26,5	1,5	83,0	48,0	275,0	0,9	8,0	10,0	LC..3008..
CFOL3225P08L230140-JET	02703595	140,0	230,0	32	25	170	26,5	1,5	83,0	48,0	275,0	0,9	8,0	10,0	LC..3008..
CFOL3225P08L500200-JET	02703596	200,0	500,0	32	25	170	26,5	1,5	83,0	48,0	275,0	0,9	8,0	10,0	LC..3008..

Spare Parts

For size	Clamp key	Clamp screw	Plug
CFOR/L...08	 6SMS795	 TCEI1020	 JET-P1/8-5MM

General ISO Turning
Steadyline®
MDT
Mini-Shaft™
Grooving
Parting-off
X4
Adapters Clamping units
Accessories and Spare parts
Workpiece materials

CFOR...R...JET, CFOL...L...JET – Toolholders for inserts LCGF, LCGN, LCMF and LCMR – Inch

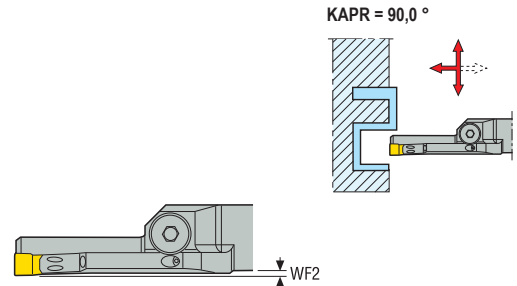
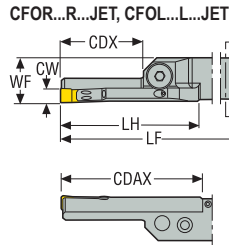

CTWS



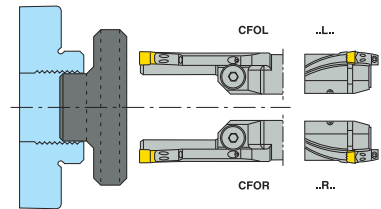

- For inserts program, see page(s) 839, 842-844
- Initial plunge (INPLM/INPLX) relates to face groove diameter, see page(s) 705
- For more information on Jetstream Tooling® (High pressure coolant) and accessories, please see page(s) 38, 85-89, 1002
- CTWS = Insert shape and size
- ** Max depth of cut for double-sided LCGF/LCMF16.. = 0.551 inch, LCGF/LCMF30.. = 1.102 inch
- *** Max coolant pressure using hose connection
- CDX = 6 x CW
- Right-hand version with right-hand blade shown
- Please check availability at www.secotools.com / Seco Online Store



Designation	Item number	INPLM	INPLX	H	B	LF	WF	WF2	LH	CDX**	CP***	Weight	CW	TQ	CTWS
		Inch	Inch	Inch	Inch	Inch	Inch	Inch	Inch	Inch	psi	lbs	Inch	In/Lbs.	
CFOR10003D-R3.102.17-JET	02719007	2.165	3.150	1.000	1.000	6.000	1.043	0.059	1.693	0.709	3988.5	1.760	0.118	53.1	LC..1603..
CFOR10003D-R4.002.75-JET	02703472	2.756	3.937	1.000	1.000	6.000	1.043	0.059	1.693	0.709	3988.5	1.540	0.118	53.1	LC..1603..
CFOR10003D-R5.003.50-JET	02703473	3.543	5.118	1.000	1.000	6.000	1.043	0.059	1.693	0.709	3988.5	1.540	0.118	53.1	LC..1603..
CFOR10003D-R6.704.30-JET	02703474	4.331	6.693	1.000	1.000	6.000	1.043	0.059	1.693	0.709	3988.5	1.540	0.118	53.1	LC..1603..
CFOR10003D-R9.005.50-JET	02703475	5.512	9.055	1.000	1.000	6.000	1.043	0.059	1.693	0.709	3988.5	1.540	0.118	53.1	LC..1603..
CFOR10003D-R19.78.00-JET	02703476	7.874	19.685	1.000	1.000	6.000	1.043	0.059	1.693	0.709	3988.5	1.540	0.118	53.1	LC..1603..
CFOL10003D-L3.102.17-JET	02719003	2.165	3.150	1.000	1.000	6.000	1.043	0.059	1.693	0.709	3988.5	1.760	0.118	53.1	LC..1603..
CFOL10003D-L4.002.75-JET	02703448	2.756	3.937	1.000	1.000	6.000	1.043	0.059	1.693	0.709	3988.5	1.540	0.118	53.1	LC..1603..
CFOL10003D-L5.003.50-JET	02703449	3.543	5.118	1.000	1.000	6.000	1.043	0.059	1.693	0.709	3988.5	1.540	0.118	53.1	LC..1603..
CFOL10003D-L6.704.30-JET	02703450	4.331	6.693	1.000	1.000	6.000	1.043	0.059	1.693	0.709	3988.5	1.540	0.118	53.1	LC..1603..
CFOL10003D-L9.005.50-JET	02703451	5.512	9.055	1.000	1.000	6.000	1.043	0.059	1.693	0.709	3988.5	1.540	0.118	53.1	LC..1603..
CFOL10003D-L19.78.00-JET	02703452	7.874	19.685	1.000	1.000	6.000	1.043	0.059	1.693	0.709	3988.5	1.540	0.118	53.1	LC..1603..
CFOR10004D-R3.102.17-JET	02719008	2.165	3.150	1.000	1.004	6.000	1.043	0.059	2.008	0.945	3988.5	1.540	0.157	70.8	LC..1604..
CFOR10004D-R4.002.75-JET	02703477	2.756	3.937	1.000	1.000	6.000	1.043	0.059	2.008	0.945	3988.5	1.540	0.157	70.8	LC..1604..
CFOR10004D-R5.003.50-JET	02703478	3.543	5.118	1.000	1.000	6.000	1.043	0.059	2.008	0.945	3988.5	1.540	0.157	70.8	LC..1604..
CFOR10004D-R6.704.30-JET	02703479	4.331	6.693	1.000	1.000	6.000	1.043	0.059	2.008	0.945	3988.5	1.540	0.157	70.8	LC..1604..
CFOR10004D-R9.005.50-JET	02703480	5.512	9.055	1.000	1.000	6.000	1.043	0.059	2.008	0.945	3988.5	1.540	0.157	70.8	LC..1604..
CFOR10004D-R19.78.00-JET	02703481	7.874	19.685	1.000	1.000	6.000	1.043	0.059	2.008	0.945	3988.5	1.540	0.157	70.8	LC..1604..
CFOL10004D-L3.102.17-JET	02719004	2.165	3.150	1.000	1.000	6.000	1.043	0.059	2.008	0.945	3988.5	1.540	0.157	70.8	LC..1604..
CFOL10004D-L4.002.75-JET	02703453	2.756	3.937	1.000	1.000	6.000	1.043	0.059	2.008	0.945	3988.5	1.540	0.157	70.8	LC..1604..
CFOL10004D-L5.003.50-JET	02703454	3.543	5.118	1.000	1.000	6.000	1.043	0.059	2.008	0.945	3988.5	1.540	0.157	70.8	LC..1604..
CFOL10004D-L6.704.30-JET	02703455	4.331	6.693	1.000	1.000	6.000	1.043	0.059	2.008	0.945	3988.5	1.540	0.157	70.8	LC..1604..
CFOL10004D-L9.005.50-JET	02703456	5.512	9.055	1.000	1.000	6.000	1.043	0.059	2.008	0.945	3988.5	1.540	0.157	70.8	LC..1604..
CFOL10004D-L19.78.00-JET	02703457	7.874	19.685	1.000	1.000	6.000	1.043	0.059	2.008	0.945	3988.5	1.540	0.157	70.8	LC..1604..
CFOR10005D-R3.102.17-JET	02719009	2.165	3.150	1.000	1.000	6.000	1.043	0.059	2.283	1.181	3988.5	1.540	0.197	70.8	LC..1605..
CFOR10005D-R4.002.75-JET	02703482	2.756	3.937	1.000	1.000	6.000	1.043	0.059	2.283	1.181	3988.5	1.540	0.197	70.8	LC..1605..
CFOR10005D-R5.003.50-JET	02703483	3.543	5.118	1.000	1.000	6.000	1.043	0.059	2.283	1.181	3988.5	1.540	0.197	70.8	LC..1605..
CFOR10005D-R6.704.30-JET	02703484	4.331	6.693	1.000	1.000	6.000	1.043	0.059	2.283	1.181	3988.5	1.540	0.197	70.8	LC..1605..
CFOR10005D-R9.005.50-JET	02703485	5.512	9.055	1.000	1.000	6.000	1.043	0.059	2.283	1.181	3988.5	1.540	0.197	70.8	LC..1605..
CFOR10005D-R19.78.00-JET	02703486	7.874	19.685	1.000	1.000	6.000	1.043	0.059	2.283	1.181	3988.5	1.540	0.197	70.8	LC..1605..

Designation	Item number	INPLM	INPLX	H	B	LF	WF	WF2	LH	CDX**	CP***	Weight	CW	TQ	CTWS
		Inch	Inch	Inch	Inch	Inch	Inch	Inch	Inch	Inch	Inch	psi	lbs	Inch	In/Lbs.
CFOL10005D-L3.102.17-JET	02719005	2.165	3.150	1.000	1.000	6.000	1.043	0.059	2.283	1.181	3988.5	1.540	0.197	70.8	LC..1605..
CFOL10005D-L4.002.75-JET	02703458	2.756	3.937	1.000	1.000	6.000	1.043	0.059	2.283	1.181	3988.5	1.540	0.197	70.8	LC..1605..
CFOL10005D-L5.003.50-JET	02703459	3.543	5.118	1.000	1.000	6.000	1.043	0.059	2.283	1.181	3988.5	1.540	0.197	70.8	LC..1605..
CFOL10005D-L6.704.30-JET	02703460	4.331	6.693	1.000	1.000	6.000	1.043	0.059	2.283	1.181	3988.5	1.540	0.197	70.8	LC..1605..
CFOL10005D-L9.005.50-JET	02703461	5.512	9.055	1.000	1.000	6.000	1.043	0.059	2.283	1.181	3988.5	1.540	0.197	70.8	LC..1605..
CFOL10005D-L19.78.00-JET	02703462	7.874	19.685	1.000	1.000	6.000	1.043	0.059	2.283	1.181	3988.5	1.540	0.197	70.8	LC..1605..
CFOR10006D-R3.102.17-JET	02719010	2.165	3.150	1.000	1.000	6.000	1.043	0.059	2.756	1.417	3988.5	1.760	0.236	88.5	LC..1606..
CFOR10006D-R4.002.75-JET	02703487	2.756	3.937	1.000	1.000	6.000	1.043	0.059	2.756	1.417	3988.5	1.540	0.236	88.5	LC..1606..
CFOR10006D-R5.003.50-JET	02703488	3.543	5.118	1.000	1.000	6.000	1.043	0.059	2.756	1.417	3988.5	1.540	0.236	88.5	LC..1606..
CFOR10006D-R6.704.30-JET	02703489	4.331	6.693	1.000	1.000	6.000	1.043	0.059	2.756	1.417	3988.5	1.540	0.236	88.5	LC..1606..
CFOR10006D-R9.005.50-JET	02703490	5.512	9.055	1.000	1.000	6.000	1.043	0.059	2.756	1.417	3988.5	1.540	0.236	88.5	LC..1606..
CFOR10006D-R19.78.00-JET	02703491	7.874	19.685	1.000	1.000	6.000	1.043	0.059	2.756	1.417	3988.5	1.540	0.236	88.5	LC..1606..
CFOL10006D-L3.102.17-JET	02719006	2.165	3.150	1.000	1.000	6.000	1.043	0.059	2.756	1.417	3988.5	1.760	0.236	88.5	LC..1606..
CFOL10006D-L4.002.75-JET	02703463	2.756	3.937	1.000	1.000	6.000	1.043	0.059	2.756	1.417	3988.5	1.540	0.236	88.5	LC..1606..
CFOL10006D-L5.003.50-JET	02703464	3.543	5.118	1.000	1.000	6.000	1.043	0.059	2.756	1.417	3988.5	1.540	0.236	88.5	LC..1606..
CFOL10006D-L6.704.30-JET	02703465	4.331	6.693	1.000	1.000	6.000	1.043	0.059	2.756	1.417	3988.5	1.540	0.236	88.5	LC..1606..
CFOL10006D-L9.005.50-JET	02703466	5.512	9.055	1.000	1.000	6.000	1.043	0.059	2.756	1.417	3988.5	1.540	0.236	88.5	LC..1606..
CFOL10006D-L19.78.00-JET	02703467	7.874	19.685	1.000	1.000	6.000	1.043	0.059	2.756	1.417	3988.5	1.540	0.236	88.5	LC..1606..
CFOR12508E-R5.003.50-JET	02703492	3.543	5.118	1.250	1.250	7.000	1.043	0.059	3.268	1.890	3988.5	2.430	0.315	132.8	LC..3008..
CFOR12508E-R6.704.30-JET	02703493	4.331	6.693	1.250	1.250	7.000	1.043	0.059	3.268	1.890	3988.5	2.430	0.315	132.8	LC..3008..
CFOR12508E-R9.005.50-JET	02703494	5.512	9.055	1.250	1.250	7.000	1.043	0.059	3.268	1.890	3988.5	2.430	0.315	132.8	LC..3008..
CFOR12508E-R19.78.00-JET	02703495	7.874	19.685	1.250	1.250	7.000	1.043	0.059	3.268	1.890	3988.5	2.430	0.315	132.8	LC..3008..
CFOL12508E-L5.003.50-JET	02703468	3.543	5.118	1.250	1.250	7.000	1.043	0.059	3.268	1.890	3988.5	2.430	0.315	132.8	LC..3008..
CFOL12508E-L6.704.30-JET	02703469	4.331	6.693	1.250	1.250	7.000	1.043	0.059	3.268	1.890	3988.5	2.430	0.315	132.8	LC..3008..
CFOL12508E-L9.005.50-JET	02703470	5.512	9.055	1.250	1.250	7.000	1.043	0.059	3.268	1.890	3988.5	2.430	0.315	132.8	LC..3008..
CFOL12508E-L19.78.00-JET	02703471	7.874	19.685	1.250	1.250	7.000	1.043	0.059	3.268	1.890	3988.5	2.430	0.315	132.8	LC..3008..

Spare Parts

For size	Clamp key	Clamp screw	Plug
			
CFOR/L...-03	4SMS795	TCEI0513	JET-P1/8-5MM
CFOR/L...-04	5SMS795	TCEI0613	JET-P1/8-5MM
CFOR/L...-05	5SMS795	TCEI0613	JET-P1/8-5MM
CFOR/L...-06	6SMS795	TCEI0815	JET-P1/8-5MM
CFOR/L...-08	6SMS795	TCEI1020	JET-P1/8-5MM

General ISO Turning

Steadyline®

MDT

Mini-Shaft™

Grooving

Parting-off

X4

Adapters
Clamping units

Accessories and
Spare parts

Workpiece
materials

General ISO Turning

Steadyline®

MDT

Mini-Shaft™

Grooving

Parting-off

X4

Adapters
Clamping units

Accessories and
Spare parts

Workpiece
materials

C-CFIR/L – Toolholders for inserts LCGN, LCMF and LCMR – Metric/ Inch



CTWS

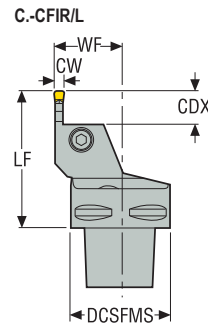

C-CFIR/L
KAPR = 90,0 °

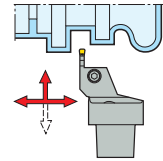

- For inserts program, see page(s) 839-844, 854-855
- * DCINN3 – minimum bore diameter for internal application, see page(s) 705
- CTMS = Seco-Capto™ size
- CTWS = Insert shape and size
- ** Max depth of cut for LCGF/LCMF16.. = 14 mm / 0.551 inch
- CDX = 3 x CW
- Right-hand version shown
- Please check availability at www.secotools.com / Seco Online Store

Designation	Item number	CTMS	DCSFMS		WF	LF	CDX**	DCINN3*	Weight	CW	TQ	CTWS							
			mm	Inch									mm	Inch					
C4-CFIR-27055-03	00091707	C4	40,0	1.575	27,0	1.063	55	2.165	9,0	0.354	195,0	7.677	0,4	0.880	3,0	0.118	3,5	31.0	LC..1603..
C4-CFIL-27055-03	00091706	C4	40,0	1.575	27,0	1.063	55	2.165	9,0	0.354	195,0	7.677	0,4	0.880	3,0	0.118	3,5	31.0	LC..1603..
C4-CFIR-27055-04	00091709	C4	40,0	1.575	27,0	1.063	55	2.165	12,0	0.472	195,0	7.677	0,4	0.880	4,0	0.157	5,0	44.3	LC..1604..
C4-CFIL-27055-04	00091708	C4	40,0	1.575	27,0	1.063	55	2.165	12,0	0.472	195,0	7.677	0,4	0.880	4,0	0.157	5,0	44.3	LC..1604..
C4-CFIR-27055-05	00091711	C4	40,0	1.575	27,0	1.063	55	2.165	15,0	0.591	195,0	7.677	0,4	0.880	5,0	0.197	5,0	44.3	LC..1605..
C4-CFIL-27055-05	00091710	C4	40,0	1.575	27,0	1.063	55	2.165	15,0	0.591	195,0	7.677	0,4	0.880	5,0	0.197	5,0	44.3	LC..1605..
C5-CFIR-35060-03	00091713	C5	50,0	1.969	35,0	1.378	60	2.362	9,0	0.354	195,0	7.677	0,6	1.320	3,0	0.118	3,5	31.0	LC..1603..
C5-CFIL-35060-03	00091712	C5	50,0	1.969	35,0	1.378	60	2.362	9,0	0.354	195,0	7.677	0,6	1.320	3,0	0.118	3,5	31.0	LC..1603..
C5-CFIR-35060-04	00091715	C5	50,0	1.969	35,0	1.378	60	2.362	12,0	0.472	195,0	7.677	0,6	1.320	4,0	0.157	5,0	44.3	LC..1604..
C5-CFIL-35060-04	00091714	C5	50,0	1.969	35,0	1.378	60	2.362	12,0	0.472	195,0	7.677	0,6	1.320	4,0	0.157	5,0	44.3	LC..1604..
C5-CFIR-35060-05	00092112	C5	50,0	1.969	35,0	1.378	60	2.362	15,0	0.591	195,0	7.677	0,6	1.320	5,0	0.197	5,0	44.3	LC..1605..
C5-CFIL-35060-05	00092111	C5	50,0	1.969	35,0	1.378	60	2.362	15,0	0.591	195,0	7.677	0,6	1.320	5,0	0.197	5,0	44.3	LC..1605..
C5-CFIR-35065-06	02303613	C5	50,0	1.969	35,0	1.378	65	2.559	18,0	0.709	195,0	7.677	0,7	1.540	6,0	0.236	10,0	88.5	LC..1606..
C5-CFIL-35065-06	02415000	C5	50,0	1.969	35,0	1.378	65	2.559	18,0	0.709	195,0	7.677	0,7	1.540	6,0	0.236	10,0	88.5	LC..1606..
C6-CFIR-45065-03	00094475	C6	63,0	2.480	45,0	1.772	65	2.559	9,0	0.354	195,0	7.677	1,0	2.200	3,0	0.118	3,5	31.0	LC..1603..
C6-CFIL-45065-03	00038098	C6	63,0	2.480	45,0	1.772	65	2.559	9,0	0.354	195,0	7.677	1,0	2.200	3,0	0.118	3,5	31.0	LC..1603..
C6-CFIR-45065-04	00094476	C6	63,0	2.480	45,0	1.772	65	2.559	12,0	0.472	195,0	7.677	1,0	2.200	4,0	0.157	5,0	44.3	LC..1604..
C6-CFIL-45065-04	00038100	C6	63,0	2.480	45,0	1.772	65	2.559	12,0	0.472	195,0	7.677	1,0	2.200	4,0	0.157	5,0	44.3	LC..1604..

Designation	Item number	CTMS	DCSFMS	WF	LF	CDX**	DCINN3*	Weight	CW	TQ	CTWS
			mm Inch	mm Inch	mm Inch	mm Inch	mm Inch	kg lbs	mm Inch	Nm In/Lbs.	
C6-CFIR-45065-05	00094477	C6	63,0 2.480	45,0 1.772	65 2.559	15,0 0.591	195,0 7.677	1,0 2.200	5,0 0.197	5,0 44.3	LC..1605..
C6-CFIL-45065-05	00012730	C6	63,0 2.480	45,0 1.772	65 2.559	15,0 0.591	195,0 7.677	1,0 2.200	5,0 0.197	5,0 44.3	LC..1605..
C6-CFIR-45065-06	00012338	C6	63,0 2.480	45,0 1.772	65 2.559	18,0 0.709	195,0 7.677	1,0 2.200	6,0 0.236	10,0 88.5	LC..1606..
C6-CFIL-45065-06	00012340	C6	63,0 2.480	45,0 1.772	65 2.559	18,0 0.709	195,0 7.677	1,0 2.200	6,0 0.236	10,0 88.5	LC..1606..
C6-CFIR-45075-08	00038107	C6	63,0 2.480	45,0 1.772	75 2.953	24,0 0.945	195,0 7.677	1,2 2.650	8,0 0.315	10,0 88.5	LC..3008..
C6-CFIL-45075-08	00038106	C6	63,0 2.480	45,0 1.772	75 2.953	24,0 0.945	195,0 7.677	1,2 2.650	8,0 0.315	10,0 88.5	LC..3008..

Spare Parts

For size	Clamp key	Clamp screw	Coolant nozzle
			
C4..-03	3SMS795	MC6S4X18	CN6
C4..-04	4SMS795	MC6S5X18	CN6
C4..-05	4SMS795	MC6S5X18	CN6
C5..-03	3SMS795	MC6S4X18	CN7
C5..-04	4SMS795	MC6S5X18	CN7
C5..-05	4SMS795	MC6S5X18	CN7
C5..-06	6SMS795	TCEI0815	CN7
CFIR/L..-03	3SMS795	MC6S4X18	CN7
CFIR/L..-04	4SMS795	MC6S5X18	CN7
CFIR/L..-05	4SMS795	MC6S5X18	CN7
CFIR/L..-06	6SMS795	TCEI0815	CN7
CFIR/L..-08	6SMS795	TCEI0825	CN7

General ISO Turning

Steadyline®

MDT

Mini-Shaft™

Grooving

Parting-off

X4

Adapters
Clamping units

Accessories and
Spare parts

Workpiece
materials

General ISO Turning

Steadyline®

MDT

Mini-Shaft™

Grooving

Parting-off

X4

Adapters
Clamping units

Accessories and
Spare parts

Workpiece
materials

CFIR/L – Toolholders for inserts LCGF, LCGN, LCMF and LCMR – Metric

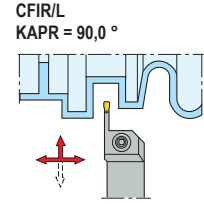
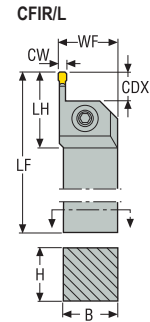
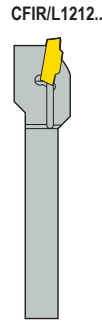
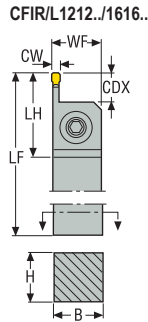



- For inserts program, see page(s) 839-852, 854-855
- * DCINN3 – minimum bore diameter for internal application, see page(s) 705
- ** Max depth of cut for LCGF/LCMF16.. = 14 mm
- CTWS = Insert shape and size
- CDX = 3 x CW
- Right-hand version shown
- Please check availability at www.secotools.com / Seco Online Store

Designation	Item number	H	B	LF	WF	LH	CDX**	DCINN3*	Weight	CW	TQ	CTWS
		mm	mm	mm	mm	mm	mm	mm	kg	mm	Nm	
CFIR1212M03	02435854	12	12	150	12,0	31,0	9,0	–	0,2	3,0	2,5	LC..1603..
CFIR1616H03	00091799	16	16	100	16,0	28,0	9,0	–	0,2	3,0	6,0	LC..1603..
CFIR2020K03	00068771	20	20	125	21,5	28,0	9,0	–	0,4	3,0	6,0	LC..1603..
CFIR2525M03	00068773	25	25	150	26,5	28,0	9,0	195,0	0,7	3,0	6,0	LC..1603..
CFIR3225P03	00013453	32	25	170	26,5	28,0	9,0	195,0	1,0	3,0	6,0	LC..1603..
CFIL1212M03	02435855	12	12	150	12,0	31,0	9,0	–	0,2	3,0	2,5	LC..1603..
CFIL1616H03	00091798	16	16	100	16,0	28,0	9,0	–	0,2	3,0	6,0	LC..1603..
CFIL2020K03	00068770	20	20	125	21,5	28,0	9,0	–	0,4	3,0	6,0	LC..1603..
CFIL2525M03	00068772	25	25	150	26,5	28,0	9,0	195,0	0,7	3,0	6,0	LC..1603..
CFIL3225P03	00013452	32	25	170	26,5	28,0	9,0	195,0	1,0	3,0	6,0	LC..1603..
CFIR1212M04	02435857	12	12	150	12,0	33,0	12,0	–	0,2	4,0	3,5	LC..1604..
CFIR1616H04	00091801	16	16	100	16,0	31,0	12,0	–	0,2	4,0	8,0	LC..1604..
CFIR2020K04	00068783	20	20	125	21,5	31,0	12,0	–	0,4	4,0	8,0	LC..1604..
CFIR2525M04	00068785	25	25	150	26,5	31,0	12,0	195,0	0,7	4,0	8,0	LC..1604..
CFIR3225P04	00091803	32	25	170	26,5	31,0	12,0	195,0	1,0	4,0	8,0	LC..1604..
CFIL1212M04	02435861	12	12	150	12,0	33,0	12,0	–	0,2	4,0	3,5	LC..1604..
CFIL1616H04	00091800	16	16	100	16,0	31,0	12,0	–	0,2	4,0	8,0	LC..1604..
CFIL2020K04	00068782	20	20	125	21,5	31,0	12,0	–	0,4	4,0	8,0	LC..1604..
CFIL2525M04	00068784	25	25	150	26,5	31,0	12,0	195,0	0,7	4,0	8,0	LC..1604..
CFIL3225P04	00091802	32	25	170	26,5	31,0	12,0	195,0	1,0	4,0	8,0	LC..1604..
CFIR2020K05	00068769	20	20	125	21,5	35,0	15,0	–	0,4	5,0	8,0	LC..1605..
CFIR2525M05	00068775	25	25	150	26,5	35,0	15,0	195,0	0,7	5,0	8,0	LC..1605..
CFIR3225P05	00091993	32	25	170	26,5	35,0	15,0	195,0	1,0	5,0	8,0	LC..1605..
CFIL2020K05	00068768	20	20	125	21,5	35,0	15,0	–	0,4	5,0	8,0	LC..1605..
CFIL2525M05	00068774	25	25	150	26,5	35,0	15,0	195,0	0,7	5,0	8,0	LC..1605..
CFIL3225P05	00091804	32	25	170	26,5	35,0	15,0	195,0	1,0	5,0	8,0	LC..1605..
CFIR2020K06	00068781	20	20	125	21,5	42,0	18,0	–	0,4	6,0	10,0	LC..1606..
CFIR2525M06	00068797	25	25	150	26,5	42,0	18,0	195,0	0,7	6,0	10,0	LC..1606..
CFIR3225P06	00068799	32	25	170	26,5	42,0	18,0	195,0	1,0	6,0	10,0	LC..1606..
CFIL2020K06	00068780	20	20	125	21,5	42,0	18,0	–	0,4	6,0	10,0	LC..1606..
CFIL2525M06	00068796	25	25	150	26,5	42,0	18,0	195,0	0,7	6,0	10,0	LC..1606..

Designation	Item number	H	B	LF	WF	LH	CDX**	DCINN3*	Weight	CW	TQ	CTWS
		mm	mm	mm	mm	mm	mm	mm	kg	mm	Nm	
CFIL3225P06	00068798	32	25	170	26,5	42,0	18,0	195,0	1,0	6,0	10,0	LC..1606..
CFIR2525M08	00023573	25	25	150	28,0	55,0	24,0	195,0	0,7	8,0	15,0	LC..3008..
CFIR3225P08	00004358	32	25	170	28,0	55,0	24,0	195,0	1,0	8,0	15,0	LC..3008..
CFIL2525M08	00023572	25	25	150	28,0	55,0	24,0	195,0	0,7	8,0	15,0	LC..3008..
CFIL3225P08	00004359	32	25	170	28,0	55,0	24,0	195,0	1,0	8,0	15,0	LC..3008..

Spare Parts

For size	Clamp key	Clamp screw
		
..1212M03	3SMS795	TCEI0409
..1616H03	4SMS795	TCEI0509
..2020K03	4SMS795	TCEI0513
..2525M03	4SMS795	TCEI0513
..3225P03	4SMS795	TCEI0513
..1212M04	3SMS795	TCEI0409
..1616H04	5SMS795	TCEI0609
..2020K04	5SMS795	TCEI0613
..2525M04	5SMS795	TCEI0613
..3225P04	5SMS795	TCEI0613
CFIR/L..-05	5SMS795	TCEI0613
CFIR/L..-06	6SMS795	TCEI0815
CFIR/L..-08	6SMS795	TCEI1020

General ISO Turning

Steadyline®

MDT

Mini-Shaft™

Grooving

Parting-off

X4

Adapters
Clamping units

Accessories and
Spare parts

Workpiece
materials

General ISO Turning

Steadyline®

MDT

Mini-Shaft™

Grooving

Parting-off

X4

Adapters
Clamping units

Accessories and
Spare parts

Workpiece
materials

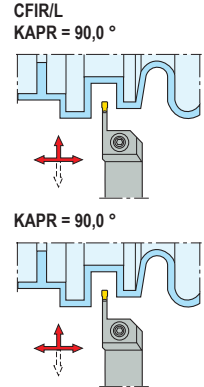
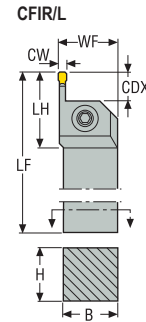
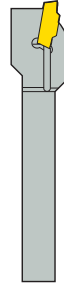
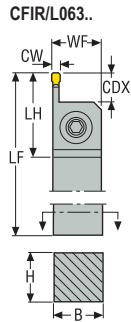

CFIR/L – Toolholders for inserts LCGF, LCGN, LCMF and LCMR – Inch



- For inserts program, see page(s) 839-852, 854-855
- * DCINN3 – minimum bore diameter for internal application, see page(s) 705
- CTWS = Insert shape and size
- CDX = 3 x CW
- Right-hand version shown
- Please check availability at www.secotools.com / Seco Online Store

Designation	Item number	H	B	LF	WF	LH	CDX**	DCINN*	Weight	CW	TQ	CTWS
		Inch	Inch	Inch	Inch	Inch	Inch	Inch				
CFIR06303B	00002795	0.625	0.625	4.500	0.875	1.142	0.354	–	0.660	0.118	53.1	LC..1603..
CFIR07503B	00087626	0.750	0.750	4.500	1.000	1.142	0.354	–	1.320	0.118	53.1	LC..1603..
CFIR10003D	00087628	1.000	1.000	6.000	1.250	1.142	0.354	7.677	1.760	0.118	53.1	LC..1603..
CFIR12503D	00002809	1.250	1.250	6.000	1.500	1.142	0.354	7.677	2.870	0.118	53.1	LC..1603..
CFIL06303B	00002800	0.625	0.625	4.500	0.875	1.142	0.354	–	0.660	0.118	53.1	LC..1603..
CFIL07503B	00087627	0.750	0.750	4.500	1.000	1.142	0.354	–	1.320	0.118	53.1	LC..1603..
CFIL10003D	00087629	1.000	1.000	6.000	1.250	1.142	0.354	7.677	1.760	0.118	53.1	LC..1603..
CFIL12503D	00002811	1.250	1.250	6.000	1.500	1.142	0.354	7.677	2.870	0.118	53.1	LC..1603..
CFIR07504B	00087630	0.750	0.750	4.500	1.000	1.220	0.472	–	0.880	0.157	70.8	LC..1604..
CFIR10004D	00087632	1.000	1.000	6.000	1.250	1.220	0.472	7.677	1.760	0.157	70.8	LC..1604..
CFIL12504D	00002813	1.250	1.250	6.000	1.500	1.220	0.472	7.677	2.870	0.157	70.8	LC..1604..
CFIL07504B	00087631	0.750	0.750	4.500	1.000	1.220	0.472	–	0.880	0.157	70.8	LC..1604..
CFIL10004D	00087633	1.000	1.000	6.000	1.250	1.220	0.472	7.677	1.760	0.157	70.8	LC..1604..
CFIL12504D	00002817	1.250	1.250	6.000	1.500	1.220	0.472	7.677	2.870	0.157	70.8	LC..1604..
CFIR07505B	00089897	0.750	0.750	4.500	1.000	1.417	0.591	–	0.880	0.197	70.8	LC..1605..
CFIR10005D	00090975	1.000	1.000	6.000	1.250	1.299	0.591	7.677	1.760	0.197	70.8	LC..1605..
CFIR12505D	00002821	1.250	1.250	6.000	1.500	1.614	0.591	7.677	2.870	0.197	70.8	LC..1605..
CFIL07505B	00089896	0.750	0.750	4.500	1.000	1.417	0.591	–	0.880	0.197	70.8	LC..1605..
CFIL10005D	00090974	1.000	1.000	6.000	1.250	1.299	0.591	7.677	1.760	0.197	70.8	LC..1605..
CFIL12505D	00002822	1.250	1.250	6.000	1.500	1.614	0.591	7.677	2.870	0.197	70.8	LC..1605..
CFIR10006D	00087634	1.000	1.000	6.000	1.250	1.614	0.709	7.677	1.760	0.236	88.5	LC..1606..
CFIR12506D	00087636	1.250	1.250	6.000	1.500	1.614	0.709	7.677	2.650	0.236	88.5	LC..1606..
CFIL10006D	00087635	1.000	1.000	6.000	1.250	1.614	0.709	7.677	1.760	0.236	88.5	LC..1606..
CFIL12506D	00087637	1.250	1.250	6.000	1.500	1.614	0.709	7.677	2.650	0.236	88.5	LC..1606..
CFIR10008D	00057717	1.000	1.000	6.000	1.250	2.165	0.996	7.677	1.760	0.315	132.8	LC..3008..
CFIR12508E	00057719	1.250	1.250	7.000	1.500	2.165	0.945	7.677	2.870	0.315	132.8	LC..3008..
CFIL10008D	00057718	1.000	1.000	6.000	1.250	2.165	0.996	7.677	1.760	0.315	132.8	LC..3008..
CFIL12508E	00057720	1.250	1.250	7.000	1.500	2.165	0.945	7.677	2.870	0.315	132.8	LC..3008..

Spare Parts

For size	Clamp key	Clamp screw
		
.03	4SMS795	TCEI0509
.03	4SMS795	TCEI0513
.04	5SMS795	TCEI0613
.05	5SMS795	TCEI0613
.06	6SMS795	TCEI0815
.08	6SMS795	TCEI1020

- General ISO Turning
- Steadyline®
- MDT
- Mini-Shaft™
- Grooving
- Parting-off
- X4
- Adapters
Clamping units
- Accessories and
Spare parts
- Workpiece
materials

General ISO Turning

Steadyline®

MDT

Mini-Shaft™

Grooving

Parting-off

X4

Adapters
Clamping units

Accessories and
Spare parts

Workpiece
materials

CFMR/L – Toolholders for inserts LCGF, LCGN, LCMF and LCMR – Metric



CTWS

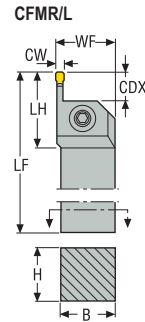

CFMR/L
KAPR = 90,0 °

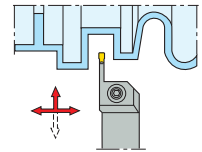

- For inserts program, see page(s) 839-852, 854-855
- * DCINN3 – minimum bore diameter for internal application, see page(s) 705
- ** Max depth of cut for double-sided LCGF/LCMF16.. = 14 mm, LCGF/LCMF30.. = 28 mm
- CTWS = Insert shape and size
- CDX = 5 x CW
- Right-hand version shown
- Please check availability at www.secotools.com / Seco Online Store

Designation	Item number	H	B	LF	WF	LH	CDX**	DCINN3*	Weight	CW	TQ	CTWS
		mm	mm	mm	mm	mm	mm	mm	kg	mm	Nm	
CFMR2020K03	00068777	20	20	125	21,5	36,0	15,0	–	0,4	3,0	6,0	LC..1603..
CFMR2525M03	00068779	25	25	150	26,5	36,0	15,0	195,0	0,7	3,0	6,0	LC..1603..
CFMR3225P03	00013460	32	25	170	26,5	36,0	15,0	195,0	1,0	3,0	6,0	LC..1603..
CFML2020K03	00068776	20	20	125	21,5	36,0	15,0	–	0,4	3,0	6,0	LC..1603..
CFML2525M03	00068778	25	25	150	26,5	36,0	15,0	195,0	0,7	3,0	6,0	LC..1603..
CFML3225P03	00013459	32	25	170	26,5	36,0	15,0	195,0	1,0	3,0	6,0	LC..1603..
CFMR2020K04	00068791	20	20	125	21,5	39,0	20,0	–	0,4	4,0	8,0	LC..1604..
CFMR2525M04	00068793	25	25	150	26,5	41,0	20,0	195,0	0,7	4,0	8,0	LC..1604..
CFMR3225P04	00091807	32	25	170	26,5	41,0	20,0	195,0	1,0	4,0	8,0	LC..1604..
CFML2020K04	00068790	20	20	125	21,5	39,0	20,0	–	0,4	4,0	8,0	LC..1604..
CFML2525M04	00068792	25	25	150	26,5	41,0	20,0	195,0	0,7	4,0	8,0	LC..1604..
CFML3225P04	00091806	32	25	170	26,5	41,0	20,0	195,0	1,0	4,0	8,0	LC..1604..
CFMR2020K05	00068789	20	20	125	21,5	50,0	25,0	–	0,4	5,0	8,0	LC..1605..
CFMR2525M05	00068787	25	25	150	26,5	50,0	25,0	195,0	0,7	5,0	8,0	LC..1605..
CFMR3225P05	00091809	32	25	170	26,5	50,0	25,0	195,0	1,0	5,0	8,0	LC..1605..
CFML2020K05	00068788	20	20	125	21,5	50,0	25,0	–	0,4	5,0	8,0	LC..1605..
CFML2525M05	00068786	25	25	150	26,5	50,0	25,0	195,0	0,7	5,0	8,0	LC..1605..
CFML3225P05	00091808	32	25	170	26,5	50,0	25,0	195,0	1,0	5,0	8,0	LC..1605..
CFMR2020M06	00068795	20	20	150	21,5	60,0	30,0	–	0,5	6,0	10,0	LC..1606..
CFMR2525M06	00068801	25	25	150	26,5	60,0	30,0	195,0	0,7	6,0	10,0	LC..1606..
CFMR3225P06	00068803	32	25	170	26,5	60,0	30,0	195,0	1,0	6,0	10,0	LC..1606..
CFML2020M06	00068794	20	20	150	21,5	60,0	30,0	–	0,5	6,0	10,0	LC..1606..
CFML2525M06	00068800	25	25	150	26,5	60,0	30,0	195,0	0,7	6,0	10,0	LC..1606..
CFML3225P06	00068802	32	25	170	26,5	60,0	30,0	195,0	1,0	6,0	10,0	LC..1606..
CFMR2525P08	00023576	25	25	170	28,0	74,0	40,0	195,0	0,8	8,0	15,0	LC..3008..
CFMR3225P08	00004360	32	25	170	28,0	74,0	40,0	195,0	1,0	8,0	15,0	LC..3008..
CFML2525P08	00023574	25	25	170	28,0	74,0	40,0	195,0	0,8	8,0	15,0	LC..3008..
CFML3225P08	00004362	32	25	170	28,0	74,0	40,0	195,0	0,9	8,0	15,0	LC..3008..

Spare Parts

For size	Clamp key	Clamp screw
		
CFMR/L...03	4SMS795	TCEI0513
CFMR/L...04	5SMS795	TCEI0613
CFMR/L...05	5SMS795	TCEI0613
CFMR/L...06	6SMS795	TCEI0815
CFMR/L...08	6SMS795	TCEI1020

General ISO Turning

Steadyline®

MDT

Mini-Shaft™

Grooving

Parting-off

X4

Adapters
Clamping units

Accessories and
Spare parts

Workpiece
materials

General ISO Turning

Steadyline®

MDT

Mini-Shaft™

Grooving

Parting-off

X4

Adapters
Clamping units

Accessories and
Spare parts

Workpiece
materials

CFMR/L – Toolholders for inserts LCGF, LCGN, LCMF and LCMR – Inch



CTWS

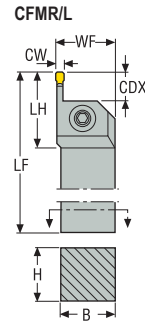

CFMR/L
KAPR = 90,0 °

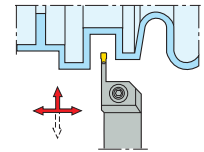

- For inserts program, see page(s) 839-852, 854-855
- * DCINN3 – minimum bore diameter for internal application, see page(s) 705
- CTWS = Insert shape and size
- ** Max depth of cut for LCGF/LCMF16.. = 0.551 inch
- CDX = 5 x CW
- Right-hand version shown
- Please check availability at www.secotools.com / Seco Online Store

Designation	Item number	H	B	LF	WF	LH	CDX**	DCINN*	Weight	CW	TQ	CTWS
		Inch	Inch	Inch	Inch	Inch	Inch	Inch	lbs	Inch	In/Lbs.	
CFML07503B	00002850	0.750	0.750	4.500	1.000	1.339	0.591	–	0.880	0.118	53.1	LC..1603..
CFML07504B	00002919	0.750	0.750	4.500	1.000	1.575	0.787	–	0.880	0.157	70.8	LC..1604..
CFML10003D	00096175	1.000	1.000	6.000	1.250	1.378	0.591	7.677	1.540	0.118	53.1	LC..1603..
CFML10004D	00096177	1.000	1.000	6.000	1.250	1.614	0.787	7.677	1.540	0.157	70.8	LC..1604..
CFML10005D	00096179	1.000	1.000	6.000	1.250	2.008	0.984	7.677	1.540	0.197	70.8	LC..1605..
CFML10006D	00096181	1.000	1.000	6.000	1.250	2.362	1.181	7.677	1.540	0.236	88.5	LC..1606..
CFML10008D	00059848	1.000	1.000	6.000	1.250	2.795	1.575	7.677	1.760	0.315	132.8	LC..3008..
CFML12503D	00002863	1.250	1.250	6.000	1.500	1.378	0.591	7.677	2.200	0.118	53.1	LC..1603..
CFML12504D	00002922	1.250	1.250	6.000	1.500	1.614	0.787	7.677	2.200	0.157	70.8	LC..1604..
CFML12505D	00002924	1.250	1.250	6.000	1.500	1.969	0.984	7.677	2.430	0.197	70.8	LC..1605..
CFML12506D	00002972	1.250	1.250	6.000	1.500	2.362	1.181	7.677	2.430	0.236	88.5	LC..1606..
CFML12508E	00059850	1.250	1.250	7.000	1.500	2.795	1.575	7.677	2.430	0.315	132.8	LC..3008..
CFML15003E	00059806	1.500	1.500	7.000	2.000	1.614	0.591	7.677	3.750	0.118	53.1	LC..1603..
CFML15004E	00059808	1.500	1.500	7.000	2.000	1.969	0.787	7.677	3.750	0.157	70.8	LC..1604..
CFML15005E	00059810	1.500	1.500	7.000	2.000	2.244	0.984	7.677	3.750	0.197	70.8	LC..1605..
CFML15006E	00059812	1.500	1.500	7.000	2.000	2.598	1.181	7.677	3.970	0.236	88.5	LC..1606..
CFML15008E	00059814	1.500	1.500	7.000	2.000	2.795	1.575	7.677	3.750	0.315	132.8	LC..3008..
CFMR07503B	00002849	0.750	0.750	4.500	1.000	1.339	0.591	–	0.880	0.118	53.1	LC..1603..
CFMR07504B	00002918	0.750	0.750	4.500	1.000	1.575	0.787	–	0.880	0.157	70.8	LC..1604..
CFMR10003D	00096174	1.000	1.000	6.000	1.250	1.378	0.591	7.677	1.540	0.118	53.1	LC..1603..
CFMR10004D	00096176	1.000	1.000	6.000	1.250	1.614	0.787	7.677	1.540	0.157	70.8	LC..1604..
CFMR10005D	00096178	1.000	1.000	6.000	1.250	2.008	0.984	7.677	1.540	0.197	70.8	LC..1605..
CFMR10006D	00096180	1.000	1.000	6.000	1.250	2.362	1.181	7.677	1.540	0.236	88.5	LC..1606..
CFMR10008D	00059847	1.000	1.000	6.000	1.250	2.795	1.575	7.677	1.760	0.315	132.8	LC..3008..
CFMR12503D	00002852	1.250	1.250	6.000	1.500	1.378	0.591	7.677	2.200	0.118	53.1	LC..1603..
CFMR12504D	00002920	1.250	1.250	6.000	1.500	1.614	0.787	7.677	2.200	0.157	70.8	LC..1604..
CFMR12505D	00002923	1.250	1.250	6.000	1.500	1.969	0.984	7.677	2.430	0.197	70.8	LC..1605..
CFMR12506D	00002970	1.250	1.250	6.000	1.500	2.362	1.181	7.677	2.430	0.236	88.5	LC..1606..
CFMR12508E	00059849	1.250	1.250	7.000	1.500	2.795	1.575	7.677	2.430	0.315	132.8	LC..3008..
CFMR15003E	00059805	1.500	1.500	7.000	2.000	1.614	0.591	7.677	3.750	0.118	53.1	LC..1603..
CFMR15004E	00059807	1.500	1.500	7.000	2.000	1.969	0.787	7.677	3.750	0.157	70.8	LC..1604..

Designation	Item number	H	B	LF	WF	LH	CDX**	DCINN*	Weight	CW	TQ	CTWS
		Inch	Inch	Inch	Inch	Inch	Inch	Inch	lbs	Inch	In/Lbs.	
CFMR15005E	00059809	1.500	1.500	7.000	2.000	2.244	0.984	7.677	3.750	0.197	70.8	LC..1605..
CFMR15006E	00059811	1.500	1.500	7.000	2.000	2.598	1.181	7.677	3.970	0.236	88.5	LC..1606..
CFMR15008E	00059813	1.500	1.500	7.000	2.000	2.795	1.575	7.677	3.750	0.315	132.8	LC..3008..

Spare Parts

For size	Clamp key	Clamp screw
		
.03	4SMS795	TCEI0513
.04	5SMS795	TCEI0613
.05	5SMS795	TCEI0613
.06	6SMS795	TCEI0815
.08	6SMS795	TCEI1020

General ISO Turning

Steadyline®

MDT

Mini-Shaft™

Grooving

Parting-off

X4

Adapters
Clamping units

Accessories and
Spare parts

Workpiece
materials

General ISO Turning

CF.R/L – Toolholders for inserts LCGN and LCMR – Metric

Steadyline®

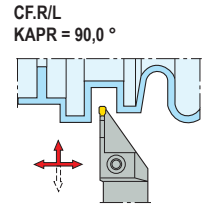
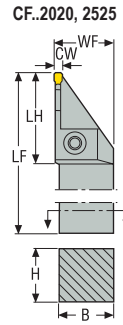
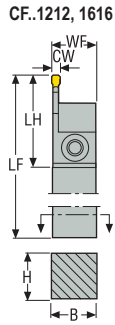

MDT

- For inserts program, see page(s) 839-852, 854-855
- CTWS = Insert shape and size
- * Due to the design, grooving depth is limited, see page(s) 705
- Right-hand version shown
- Please check availability at www.secotools.com / Seco Online Store

Mini-Shaft™

Designation	Item number	H	B	LF	WF	LH	CUTDIA*	Weight	CW	TQ	CTWS
		mm	mm	mm	mm	mm	mm	kg	mm	Nm	
CFOR1212M03	00053367	12	12	150	12,0	32,1	37,0	0,2	3,0	3,5	LC..1603..
CFOL1212M03	00053357	12	12	150	12,0	32,1	37,0	0,2	3,0	3,5	LC..1603..
CFTR1616M03	00054058	16	16	150	16,0	42,0	50,0	0,3	3,0	6,0	LC..1603..
CFTR2020K03	00054060	20	20	125	21,5	43,0	50,0	0,4	3,0	6,0	LC..1603..
CFTR2525M03	00054066	25	25	150	26,5	42,5	50,0	0,7	3,0	6,0	LC..1603..
CFTL1616M03	00054057	16	16	150	16,0	42,0	50,0	0,3	3,0	6,0	LC..1603..
CFTL2020K03	00054059	20	20	125	21,5	43,0	50,0	0,4	3,0	6,0	LC..1603..
CFTL2525M03	00054063	25	25	150	26,5	42,5	50,0	0,7	3,0	6,0	LC..1603..
CFPR2020K04	00054073	20	20	125	21,5	43,0	50,0	0,4	4,0	8,0	LC..1604..
CFPR2525M04	00054078	25	25	150	26,5	43,0	50,0	0,7	4,0	8,0	LC..1604..
CFPL2020K04	00054071	20	20	125	21,5	43,0	50,0	0,4	4,0	8,0	LC..1604..
CFPL2525M04	00054074	25	25	150	26,5	43,0	50,0	0,7	4,0	8,0	LC..1604..

Grooving

Parting-off

Spare Parts

X4

For size	Clamp key	Clamp screw
CFOR/L..-03	3SMS795	TCEI0409
CFTR/L..-03	4SMS795	TCEI0513
CFPR/L..-04	5SMS795	TCEI0613

Adapters Clamping units

Accessories and Spare parts

Workpiece materials

CF.R/L – Toolholders for inserts LCGN and LCMR – Inch

KAPR = 90,0°

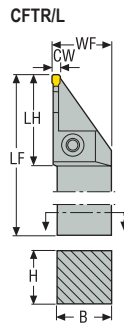
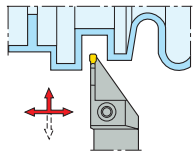

- For inserts program, see page(s) 839-852, 854-855
- CTWS = Insert shape and size
- * Due to the design, grooving depth is limited, see page(s) 705
- Right-hand version shown
- Please check availability at www.secotools.com / Seco Online Store

Designation	Item number	H	B	LF	WF	LH	CUTDIA*	Weight	CW	TQ	CTWS
		Inch	Inch	Inch	Inch	Inch	Inch	lbs	Inch	In/Lbs.	
CFTR07503C	00086323	0.750	0.750	5.000	1.000	1.654	1.969	0.880	0.118	53.1	LC..1603..
CFTR10003D	00086326	1.000	1.000	6.000	1.250	1.654	1.969	1.540	0.118	53.1	LC..1603..
CFTL07503C	00086332	0.750	0.750	5.000	1.000	1.654	1.969	0.880	0.118	53.1	LC..1603..
CFTL10003D	00086333	1.000	1.000	6.000	1.250	1.654	1.969	1.760	0.118	53.1	LC..1603..
CFPR10004D	00086317	0.626	0.626	6.000	1.250	1.693	1.969	1.760	0.157	70.8	LC..1604..
CFPL10004D	00086320	0.626	0.626	6.000	1.250	1.693	1.969	1.760	0.157	70.8	LC..1604..

Spare Parts

For size	Clamp key	Clamp screw
.03	4SMS795	TCEI0513
.04	5SMS795	TCEI0613

General ISO Turning

Steadyline®

MDT

Mini-Shaft™

Grooving

Parting-off

X4

Adapters
Clamping units

Accessories and
Spare parts

Workpiece
materials

General ISO Turning

Steadyline®

MDT

Mini-Shaft™

Grooving

Parting-off

X4

Adapters
Clamping units

Accessories and
Spare parts

Workpiece
materials

CF/R/L – Toolholders for inserts LCGN and LCMR – Inch



CTWS

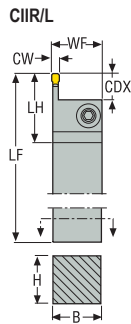

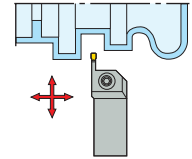

CIIR/L
KAPR = 90,0 °



- For inserts program, see page(s) 839-852, 854-855
- CTWS = Insert shape and size
- * Due to the design, grooving depth is limited, see page(s) 705
- Right-hand version shown
- Please check availability at www.secotools.com / Seco Online Store

Designation	Item number	H	B	LF	WF	LH	CDX**	Weight	CW	TQ	CTWS
		Inch	Inch	Inch	Inch	Inch	Inch	lbs	Inch	In/Lbs.	
CIIR05003D	00057794	0.500	0.500	6.000	0.500	1.142	0.433	0.440	0.118	53.1	LC..1603..
CIIR062503B	00057792	0.625	0.625	4.500	0.625	1.142	0.433	0.660	0.118	53.1	LC..1603..
CIIL05003D	00057795	0.500	0.500	6.000	0.500	1.142	0.433	0.440	0.118	53.1	LC..1603..
CIIL062503B	00057793	0.625	0.625	4.500	0.625	1.142	0.433	0.660	0.118	53.1	LC..1603..

Spare Parts

For size	Clamp key	Clamp screw
.03	 4SMS795	 TCEI0509

CF.R/L..RB – Toolholders for inserts LCMF – Metric

CF.R/L
KAPR = 90,0°

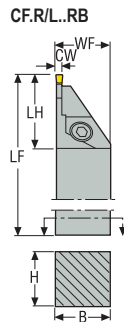
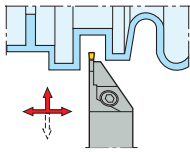

- For inserts program, see page(s) 838
- CTWS = Insert shape and size
- * Due to the design, grooving depth is limited, see page(s) 705
- Right-hand version shown
- Please check availability at www.secotools.com / Seco Online Store

Designation	Item number	H	B	LF	WF	LH	CUTDIA*	Weight	CW	TQ	CTWS
		mm	mm	mm	mm	mm	mm	kg	mm	Nm	
CFOR1212K1902RB	02748517	12	12	125	12,0	22,0	25,4	0,2	2,0	5,0	LC..1902..
CFOR1616K1902RB	02748518	16	16	125	16,0	22,0	25,4	0,3	2,0	5,0	LC..1902..
CFOL1212K1902RB	02748520	12	12	125	12,0	22,0	25,4	0,2	2,0	5,0	LC..1902..
CFOL1616K1902RB	02748523	16	16	125	16,0	22,0	25,4	0,3	2,0	5,0	LC..1902..
CFSR1212K1902RB	02748524	12	12	125	12,0	25,0	33,0	0,2	2,0	5,0	LC..1902..
CFSR1616K1902RB	02748526	16	16	125	16,0	25,0	33,0	0,3	2,0	5,0	LC..1902..
CFSL1212K1902RB	02748528	12	12	125	12,0	25,0	33,0	0,2	2,0	5,0	LC..1902..
CFSL1616K1902RB	02748530	16	16	125	16,0	25,0	33,0	0,3	2,0	5,0	LC..1902..

Spare Parts

For size	Clamp key	Clamp screw
CFOR/L..19	T15P-7S	L85012-T15P
CFSR/L..19	T15P-7S	L85012-T15P

General ISO Turning

Steadyline®

MDT

Mini-Shaft™

Grooving

Parting-off

X4

Adapters
Clamping units

Accessories and
Spare parts

Workpiece
materials

General ISO Turning

CF.R/L..RB – Toolholders for inserts LCMF – Inch

Steadyline®



CTWS

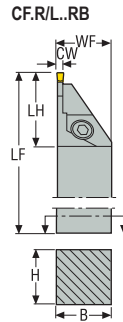

CF.R/L
KAPR = 90,0 °

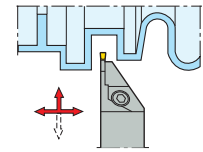

MDT

- For inserts program, see page(s) 838
- CTWS = Insert shape and size
- * Due to the design, grooving depth is limited, see page(s) 705
- Right-hand version shown
- Please check availability at www.secotools.com / Seco Online Store

Mini-Shaft™

Designation	Item number	H	B	LF	WF	LH	CUTDIA*	Weight	CW	TQ	CTWS
		Inch	Inch	Inch	Inch	Inch	Inch	lbs	Inch	In/Lbs.	
CFOR0501902CRB	02748812	0.500	0.500	5.000	0.500	0.866	1.000	0.440	0.079	44.3	LC..1902..
CFOR0631902CRB	02748816	0.625	0.625	5.000	0.625	0.866	1.000	0.660	0.079	44.3	LC..1902..
CFOL0501902CRB	02748814	0.500	0.500	5.000	0.500	0.866	1.000	0.440	0.079	44.3	LC..1902..
CFOL0631902CRB	02748817	0.625	0.625	5.000	0.625	0.866	1.000	0.660	0.079	44.3	LC..1902..
CFSR0501902CRB	02748820	0.500	0.500	5.000	0.500	0.984	1.299	0.440	0.079	44.3	LC..1902..
CFSR0631902CRB	02748826	0.625	0.625	5.000	0.625	0.984	1.299	0.660	0.079	44.3	LC..1902..
CFSL0501902CRB	02748823	0.500	0.500	5.000	0.500	0.984	1.299	0.440	0.079	44.3	LC..1902..
CFSL0631902CRB	02748828	0.625	0.625	5.000	0.625	0.984	1.299	0.660	0.079	44.3	LC..1902..

Grooving

Parting-off

Spare Parts

For size	Clamp key	Clamp screw
CF.R/L	T15P-7S	L85012-T15P

X4

Adapters
Clamping units

Accessories and
Spare parts

Workpiece
materials

CFSR/L – Toolholders for inserts LCGF, LCGN, LCMF and LCMR – Metric

CFSR/L
KAPR = 90,0°

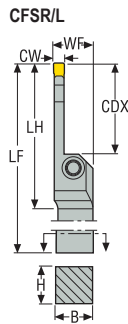
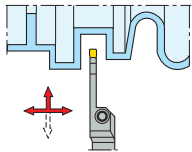

- For inserts program, see page(s) 839-852, 854-855
- * DCINN3 – minimum bore diameter for internal application, see page(s) 705
- CTWS = Insert shape and size
- ** Max depth of cut for double-sided LCGF/LCMF16.. = 14 mm, LCGF/LCMF30.. = 28 mm
- CDX = 8 x CW
- Right-hand version shown
- Please check availability at www.secotools.com / Seco Online Store

Designation	Item number	H	B	LF	WF	LH	CDX**	DCINN3*	Weight	CW	TQ	CTWS
		mm	mm	mm	mm	mm	mm	mm	kg	mm	Nm	
CFSR2525M03	02703367	25	25	150	26,5	46,0	24,0	195,0	0,7	3,0	6,0	LC..1603..
CFSR3225P03	02703375	32	25	170	26,1	46,0	24,0	195,0	1,0	3,0	6,0	LC..1603..
CFSL2525M03	02703363	25	25	150	26,5	46,0	24,0	195,0	0,7	3,0	6,0	LC..1603..
CFSL3225P03	02703371	32	25	170	26,1	46,0	24,0	195,0	1,0	3,0	6,0	LC..1603..
CFSR2525P04	00069914	25	25	170	26,5	55,0	32,0	195,0	0,6	4,0	8,0	LC..1604..
CFSR3225P04	02703376	32	25	170	26,5	55,0	32,0	195,0	0,9	4,0	8,0	LC..1604..
CFSL2525P04	02703364	25	25	170	26,5	55,0	32,0	195,0	0,7	4,0	8,0	LC..1604..
CFSL3225P04	02703372	32	25	170	26,5	55,0	32,0	195,0	0,9	4,0	8,0	LC..1604..
CFSR2525P05	02703368	25	25	170	26,5	66,0	40,0	195,0	0,7	5,0	8,0	LC..1605..
CFSR3225P05	02703377	32	25	170	26,5	66,0	40,0	195,0	0,9	5,0	8,0	LC..1605..
CFSL2525P05	02703365	25	25	170	26,5	66,0	40,0	195,0	0,7	5,0	8,0	LC..1605..
CFSL3225P05	02703373	32	25	170	26,5	66,0	40,0	195,0	0,9	5,0	8,0	LC..1605..
CFSR2525R06	02703370	25	25	200	26,5	81,0	48,0	195,0	0,8	6,0	10,0	LC..1606..
CFSR3225R06	02703378	32	25	200	26,5	81,0	48,0	195,0	1,1	6,0	10,0	LC..1606..
CFSL2525R06	02703366	25	25	200	26,5	81,0	48,0	195,0	0,8	6,0	10,0	LC..1606..
CFSL3225R06	02703374	32	25	200	26,5	81,0	48,0	195,0	1,1	6,0	10,0	LC..1606..
CFSR3225R08	02676893	32	25	200	28,0	104,0	64,0	195,0	1,0	8,0	15,0	LC..3008..
CFSL3225R08	02676892	32	25	200	28,0	104,0	64,0	195,0	1,0	8,0	15,0	LC..3008..

Spare Parts

For size	Clamp key	Clamp screw
CFSR/L..03	4SMS795	TCEI0513
CFSR/L..04	5SMS795	TCEI0613
CFSR/L..05	5SMS795	TCEI0613
CFSR/L..06	6SMS795	TCEI0815
CFSR/L..08	6SMS795	TCEI1020

General ISO Turning
Steadyline®
MDT
Mini-Shaft™
Grooving
Parting-off
X4
Adapters
Clamping units
Accessories and Spare parts
Workpiece materials

General ISO Turning

CFSR/L – Toolholders for inserts LCGF, LCGN, LCMF and LCMR – Inch

Steadyline®

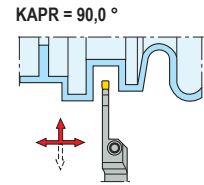
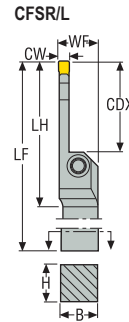

CTWS



MDT

- For inserts program, see page(s) 839-852, 854-855
- * DCINN3 – minimum bore diameter for internal application, see page(s) 705
- CTWS = Insert shape and size
- ** Max depth of cut for double-sided LCGF/LCMF16.. = 0.551 inch, LCGF/LCMF30.. = 1.102 inch
- CDX = 8 x CW
- Right-hand version shown
- Please check availability at www.secotools.com / Seco Online Store

Mini-Shaft™

Designation	Item number	H	B	LF	WF	LH	CDX**	DCINN*	Weight	CW	TQ	CTWS
		Inch	Inch	Inch	Inch	Inch	Inch	Inch		lbs	Inch	
CFSR10003D	02703393	1.000	1.000	6.000	1.250	1.811	0.945	7.677	1.760	0.118	53.1	LC..1603..
CFSR12503D	02703401	1.250	1.250	6.000	1.500	1.811	0.945	7.677	2.200	0.118	53.1	LC..1603..
CFSL10003D	02703389	1.000	1.000	6.000	1.250	1.811	0.945	7.677	2.430	0.118	53.1	LC..1603..
CFSL12503D	02703397	1.250	1.250	6.000	1.500	1.811	0.945	7.677	2.430	0.118	53.1	LC..1603..
CFSR10004E	02703394	1.000	1.000	7.000	1.250	2.165	1.260	7.677	2.430	0.157	70.8	LC..1604..
CFSR12504E	02703402	1.250	1.250	7.000	1.500	2.165	1.260	7.677	2.870	0.157	70.8	LC..1604..
CFSL10004E	02703390	1.000	1.000	7.000	1.250	2.165	1.260	7.677	1.980	0.157	70.8	LC..1604..
CFSL12504E	02703398	1.250	1.250	7.000	1.500	2.165	1.260	7.677	2.870	0.157	70.8	LC..1604..
CFSR10005E	02703395	1.000	1.000	7.000	1.250	2.598	1.575	7.677	1.980	0.197	70.8	LC..1605..
CFSR12505E	02703403	1.250	1.250	7.000	1.500	2.598	1.575	7.677	2.430	0.197	70.8	LC..1605..
CFSL10005E	02703391	1.000	1.000	7.000	1.250	2.598	1.575	7.677	1.980	0.197	70.8	LC..1605..
CFSL12505E	02703399	1.250	1.250	7.000	1.500	2.598	1.575	7.677	2.870	0.197	70.8	LC..1605..
CFSR10006F	02703396	1.000	1.000	8.000	1.250	3.189	1.890	7.677	1.980	0.236	88.5	LC..1606..
CFSR12506F	02703404	1.250	1.250	8.000	1.500	3.189	1.890	7.677	2.870	0.236	88.5	LC..1606..
CFSL10006F	02703392	1.000	1.000	8.000	1.250	3.189	1.890	7.677	1.980	0.236	88.5	LC..1606..
CFSL12506F	02703400	1.250	1.250	8.000	1.500	3.189	1.890	7.677	2.870	0.236	88.5	LC..1606..
CFSR12508F	02703406	1.250	1.250	8.000	1.500	4.094	2.520	7.677	2.430	0.315	132.8	LC..3008..
CFSL12508F	02703405	1.250	1.250	8.000	1.500	4.094	2.520	7.677	3.090	0.315	132.8	LC..3008..

Grooving

Parting-off

X4

Adapters
Clamping units

Spare Parts

For size	Clamp key	Clamp screw
..03	4SMS795	TCEI0513
..04	5SMS795	TCEI0613
..05	5SMS795	TCEI0613
..06	6SMS795	TCEI0815
..08	6SMS795	TCEI1020

Accessories and
Spare parts

Workpiece
materials

CFZR/L – Toolholders for inserts LCMF – Metric

CFZR/L
KAPR = 90,0°

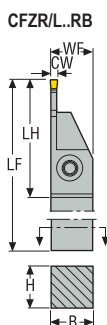
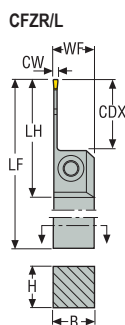
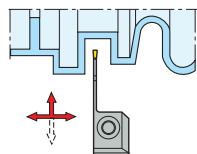



CTWS



- For inserts program, see page(s) 838
- CTWS = Insert shape and size
- * Due to the design, grooving depth is limited, see page(s) 705
- CDX = 12,5 x CW
- Right-hand version shown
- Please check availability at www.secotools.com / Seco Online Store

Designation	Item number	H	B	LF	WF	LH	CDX**	CUTDIA*	Weight	CW	TQ	CTWS
		mm	mm	mm	mm	mm	mm	mm	kg	mm	Nm	
CFZR1616M2802	02748735	16	16	150	16,0	46,0	26,0	–	0,3	2,0	6,0	LC..2802..
CFZL1616M2802	02748737	16	16	150	16,0	46,0	26,0	–	0,3	2,0	6,0	LC..2802..
CFZR1616M2802RB	02748747	16	16	150	16,0	46,0	27,5	52,0	0,3	2,0	6,0	LC..2802..
CFZL1616M2802RB	02748749	16	16	150	16,0	46,0	27,5	52,0	0,3	2,0	6,0	LC..2802..

Spare Parts

For size	Clamp key	Clamp screw
		
CFZR/L..02	4SMS795	TCEI0513

General ISO Turning

Steadyline®

MDT

Mini-Shaft™

Grooving

Parting-off

X4

Adapters
Clamping units

Accessories and
Spare parts

Workpiece
materials

General ISO Turning

CFZR/L – Toolholders for inserts LCMF – Inch

Steadyline®

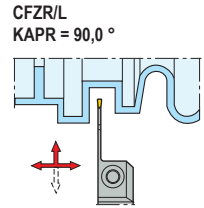
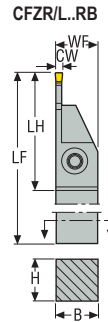
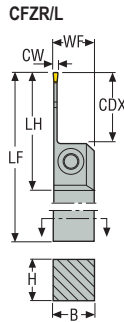

MDT

- For inserts program, see page(s) 838
- CTWS = Insert shape and size
- * Due to the design, grooving depth is limited, see page(s) 705
- CDX = 12,5 x CW
- Right-hand version shown
- Please check availability at www.secotools.com / Seco Online Store



Mini-Shaft™

Designation	Item number	H	B	LF	WF	LH	CDX**	CUTDIA*	Weight	CW	TQ	CTWS
		Inch	Inch	Inch	Inch	Inch	Inch	Inch	lbs	Inch	In/Lbs.	
CFZR0632802D	02748935	0.625	0.625	6.000	0.625	1.811	0.984	–	0.660	0.079	53.1	LC..2802..
CFZL0632802D	02749007	0.625	0.625	6.000	0.625	1.811	0.984	–	0.660	0.079	53.1	LC..2802..
CFZR0632802DRB	02749011	0.625	0.625	6.000	0.625	1.811	1.024	2.047	0.660	0.079	53.1	LC..2802..
CFZL0632802DRB	02749015	0.625	0.625	6.000	0.625	1.811	1.024	2.047	0.660	0.079	53.1	LC..2802..

Grooving

Spare Parts

Parting-off

For size	Clamp key	Clamp screw
CFZR/L	 4SMS795	 TCEI0513

X4

Adapters
Clamping units

Accessories and
Spare parts

Workpiece
materials

CFIR/L – Toolholders for inserts LCGF, LCGN, LCMF and LCMR – Metric

CFIR/L
KAPR = 90,0°

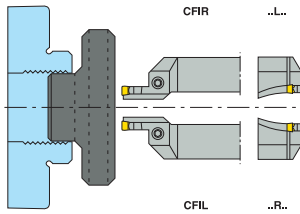
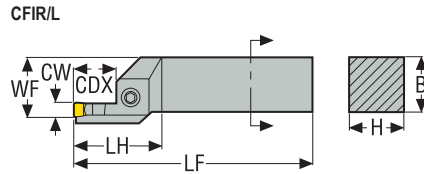
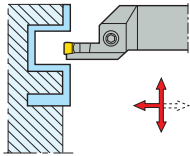

- For inserts program, see page(s) 839-844, 854-855
- Initial plunge (INPLM/INPLX) relates to face groove diameter, see page(s) 705
- CTWS = Insert shape and size
- ** Max depth of cut for LCGF/LCMF16.. = 14 mm
- CDX = 3 x CW
- Right-hand version with left-hand blade shown
- Please check availability at www.secotools.com / Seco Online Store

Designation	Item number	INPLM	INPLX	H	B	LF	WF	LH	CDX**	Weight	CW	TQ	CTWS
		mm	mm	mm	mm	mm	mm	mm	mm	kg	mm	Nm	
CFIR2525M03L100070	00089733	70	100	25	25	150	26,5	28,0	9,0	0,7	3,0	6,0	LC..1603..
CFIR2525M03L130090	00089907	90	130	25	25	150	26,5	28,0	9,0	0,7	3,0	6,0	LC..1603..
CFIR2525M03L170110	00089735	110	170	25	25	150	26,5	28,0	9,0	0,7	3,0	6,0	LC..1603..
CFIL2525M03R100070	00089734	70	100	25	25	150	26,5	28,0	9,0	0,7	3,0	6,0	LC..1603..
CFIL2525M03R130090	00089906	90	130	25	25	150	26,5	28,0	9,0	0,7	3,0	6,0	LC..1603..
CFIL2525M03R170110	00089736	110	170	25	25	150	26,5	28,0	9,0	0,7	3,0	6,0	LC..1603..
CFIR2525M04L100070	00089899	70	100	25	25	150	26,5	31,0	12,0	0,7	4,0	8,0	LC..1604..
CFIR2525M04L130090	00089901	90	130	25	25	150	26,5	31,0	12,0	0,7	4,0	8,0	LC..1604..
CFIR2525M04L170110	00089903	110	170	25	25	150	26,5	31,0	12,0	0,7	4,0	8,0	LC..1604..
CFIR2525M04L230140	00089905	140	230	25	25	150	26,5	31,0	12,0	0,7	4,0	8,0	LC..1604..
CFIL2525M04R100070	00089898	70	100	25	25	150	26,5	31,0	12,0	0,7	4,0	8,0	LC..1604..
CFIL2525M04R130090	00089900	90	130	25	25	150	26,5	31,0	12,0	0,7	4,0	8,0	LC..1604..
CFIL2525M04R170110	00089902	110	170	25	25	150	26,5	31,0	12,0	0,7	4,0	8,0	LC..1604..
CFIL2525M04R230140	00089904	140	230	25	25	150	26,5	31,0	12,0	0,7	4,0	8,0	LC..1604..
CFIR2525M05L100070	00013448	70	100	25	25	150	26,5	35,0	15,0	0,7	5,0	8,0	LC..1605..
CFIR2525M05L130090	00091813	90	130	25	25	150	26,5	35,0	15,0	0,7	5,0	8,0	LC..1605..
CFIR2525M05L170110	00091815	110	170	25	25	150	26,5	35,0	15,0	0,7	5,0	8,0	LC..1605..
CFIR2525M05L230140	00091817	140	230	25	25	150	26,5	35,0	15,0	0,7	5,0	8,0	LC..1605..
CFIL2525M05R100070	00013447	70	100	25	25	150	26,5	35,0	15,0	0,7	5,0	8,0	LC..1605..
CFIL2525M05R130090	00091812	90	130	25	25	150	26,5	35,0	15,0	0,7	5,0	8,0	LC..1605..
CFIL2525M05R170110	00091814	110	170	25	25	150	26,5	35,0	15,0	0,7	5,0	8,0	LC..1605..
CFIL2525M05R230140	00091816	140	230	25	25	150	26,5	35,0	15,0	0,7	5,0	8,0	LC..1605..
CFIR2525M06L100070	00013451	70	100	25	25	150	26,5	42,0	18,0	0,7	6,0	10,0	LC..1606..
CFIR2525M06L130090	00084469	90	130	25	25	150	26,5	42,0	18,0	0,7	6,0	10,0	LC..1606..
CFIR2525M06L170110	00084471	110	170	25	25	150	26,5	42,0	18,0	0,7	6,0	10,0	LC..1606..
CFIR2525M06L230140	00084473	140	230	25	25	150	26,5	42,0	18,0	0,7	6,0	10,0	LC..1606..
CFIL2525M06R100070	00013449	70	100	25	25	150	26,5	42,0	18,0	0,7	6,0	10,0	LC..1606..
CFIL2525M06R130090	00084470	90	130	25	25	150	26,5	42,0	18,0	0,7	6,0	10,0	LC..1606..
CFIL2525M06R170110	00084472	110	170	25	25	150	26,5	42,0	18,0	0,7	6,0	10,0	LC..1606..
CFIL2525M06R230140	00084474	140	230	25	25	150	26,5	42,0	18,0	0,7	6,0	10,0	LC..1606..

General ISO Turning

Steadyline®

MDT

Mini-Shaft™

Grooving

Parting-off

X4

Adapters
Clamping units

Accessories and
Spare parts

Workpiece
materials

	Designation	Item number	INPLM	INPLX	H	B	LF	WF	LH	CDX**	Weight	CW	TQ	CTWS
			mm	mm	mm	mm	mm	mm	mm	mm	kg	mm	Nm	
General ISO Turning	CFIR3225P08L130090	00089160	90	130	32	25	170	28,0	50,0	24,0	1,0	8,0	15,0	LC..3008..
	CFIR3225P08L170110	00089162	110	170	32	25	170	28,0	50,0	24,0	1,0	8,0	15,0	LC..3008..
	CFIR3225P08L230140	00089164	140	230	32	25	170	28,0	50,0	24,0	1,0	8,0	15,0	LC..3008..
	CFIR3225P08L500200	00089166	200	500	32	25	170	28,0	50,0	24,0	1,0	8,0	15,0	LC..3008..
	CFIL3225P08R130090	00089161	90	130	32	25	170	28,0	50,0	24,0	1,0	8,0	15,0	LC..3008..
Steadyline®	CFIL3225P08R170110	00089163	110	170	32	25	170	28,0	50,0	24,0	1,0	8,0	15,0	LC..3008..
	CFIL3225P08R230140	00089165	140	230	32	25	170	28,0	50,0	24,0	1,0	8,0	15,0	LC..3008..
	CFIL3225P08R500200	00089167	200	500	32	25	170	28,0	50,0	24,0	1,0	8,0	15,0	LC..3008..

Spare Parts

	For size	Clamp key	Clamp screw
MDT			
	CFIR/L..03	4SMS795	TCEI0513
Mini-Shaft™	CFIR/L..04	5SMS795	TCEI0613
	CFIR/L..05	5SMS795	TCEI0613
	CFIR/L..06	6SMS795	TCEI0815
	CFIR/L..08	6SMS795	TCEI1020

Grooving

Parting-off

X4

Adapters
Clamping units

Accessories and
Spare parts

Workpiece
materials

CFIR/L – Toolholders for inserts LCGF, LCGN, LCMF and LCMR – Inch

KAPR = 90,0°

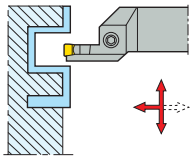

CFIR/L

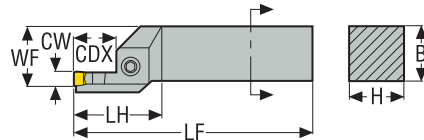

CTWS

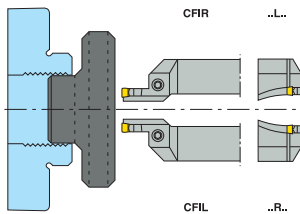

- For inserts program, see page(s) 839-844, 854-855
- Initial plunge (INPLM/INPLX) relates to face groove diameter, see page(s) 705
- CTWS = Insert shape and size
- ** Max depth of cut for LCGF/LCMF16.. = 0.551 inch
- CDX = 3 x CW
- Right-hand version with left-hand blade shown
- Please check availability at www.secotools.com / Seco Online Store

Designation	Item number	INPLM	INPLX	H	B	LF	WF	LH	CDX**	Weight	CW	TQ	CTWS
		Inch	Inch	Inch	Inch	Inch	Inch	Inch	Inch	lbs	Inch	In/Lbs.	
CFIR10003D-L4.002.75	00087773	2.756	3.937	1.000	1.000	6.000	1.250	1.142	0.354	1.760	0.118	53.1	LC..1603..
CFIR10003D-L5.003.50	00087777	3.543	5.000	1.000	1.000	6.000	1.250	1.142	0.354	1.760	0.118	53.1	LC..1603..
CFIR10003D-L6.704.30	00002840	4.331	6.693	1.000	1.000	6.000	1.250	1.142	0.354	1.760	0.118	53.1	LC..1603..
CFIL10003D-R4.002.75	00087774	2.756	3.937	1.000	1.000	6.000	1.250	1.142	0.354	1.760	0.118	53.1	LC..1603..
CFIL10003D-R5.003.50	00087778	3.543	5.000	1.000	1.000	6.000	1.250	1.142	0.354	1.760	0.118	53.1	LC..1603..
CFIL10003D-R6.704.30	00002841	4.331	6.693	1.000	1.000	6.000	1.250	1.142	0.354	1.760	0.118	53.1	LC..1603..
CFIR10004D-L4.002.75	00087785	2.756	3.937	1.000	1.000	6.000	1.250	1.299	0.472	1.760	0.157	70.8	LC..1604..
CFIR10004D-L5.003.50	00087789	3.543	5.000	1.000	1.000	6.000	1.250	1.299	0.472	1.760	0.157	70.8	LC..1604..
CFIR10004D-L9.005.50	00002842	5.512	8.976	1.000	1.000	6.000	1.250	1.299	0.472	1.760	0.157	70.8	LC..1604..
CFIL10004D-R4.002.75	00087786	2.756	3.937	1.000	1.000	6.000	1.250	1.299	0.472	1.760	0.157	70.8	LC..1604..
CFIL10004D-R5.003.50	00087790	3.543	5.000	1.000	1.000	6.000	1.250	1.299	0.472	1.760	0.157	70.8	LC..1604..
CFIL10004D-R9.005.50	00002844	5.512	8.976	1.000	1.000	6.000	1.250	1.299	0.472	1.760	0.157	70.8	LC..1604..
CFIR10005D-L4.002.75	00057796	2.756	3.937	1.000	1.000	6.000	1.250	1.417	0.591	1.760	0.197	70.8	LC..1605..
CFIR10005D-L5.003.50	00002828	3.543	5.000	1.000	1.000	6.000	1.250	1.417	0.591	1.760	0.197	70.8	LC..1605..
CFIR10005D-L6.704.30	00002835	4.331	6.693	1.000	1.000	6.000	1.250	1.417	0.591	1.760	0.197	70.8	LC..1605..
CFIR10005D-L9.005.50	00002838	5.512	8.976	1.000	1.000	6.000	1.250	1.417	0.591	1.760	0.197	70.8	LC..1605..
CFIL10005D-R4.002.75	00057797	2.756	3.937	1.000	1.000	6.000	1.250	1.417	0.591	1.760	0.197	70.8	LC..1605..
CFIL10005D-R5.003.50	00002831	3.543	5.000	1.000	1.000	6.000	1.250	1.417	0.591	1.760	0.197	70.8	LC..1605..
CFIL10005D-R6.704.30	00002836	4.331	6.693	1.000	1.000	6.000	1.250	1.417	0.591	1.760	0.197	70.8	LC..1605..
CFIL10005D-R9.005.50	00002839	5.512	8.976	1.000	1.000	6.000	1.250	1.417	0.591	1.760	0.197	70.8	LC..1605..
CFIR10006D-L4.002.75	00059845	2.756	3.937	1.000	1.000	6.000	1.250	1.693	0.709	1.760	0.236	88.5	LC..1606..
CFIR10006D-L5.003.50	00087795	3.543	5.000	1.000	1.000	6.000	1.250	1.693	0.709	1.760	0.236	88.5	LC..1606..
CFIR10006D-L6.704.30	00087799	4.331	6.693	1.000	1.000	6.000	1.250	1.693	0.709	1.760	0.236	88.5	LC..1606..
CFIR10006D-L9.005.50	00092656	5.512	8.976	1.000	1.000	6.000	1.250	1.693	0.709	1.760	0.236	88.5	LC..1606..
CFIL10006D-R4.002.75	00059846	2.756	3.937	1.000	1.000	6.000	1.250	1.693	0.709	1.760	0.236	88.5	LC..1606..
CFIL10006D-R5.003.50	00087796	3.543	5.000	1.000	1.000	6.000	1.250	1.693	0.709	1.760	0.236	88.5	LC..1606..
CFIL10006D-R6.704.30	00092653	4.331	6.693	1.000	1.000	6.000	1.250	1.693	0.709	1.760	0.236	88.5	LC..1606..
CFIL10006D-R9.005.50	00092657	5.512	8.976	1.000	1.000	6.000	1.250	1.693	0.709	1.760	0.236	88.5	LC..1606..
CFIR10008D-L5.003.50	00064884	3.543	5.000	1.000	1.000	6.000	1.250	2.205	0.945	1.760	0.315	132.8	LC..3008..
CFIR10008D-L6.704.30	00064886	4.331	6.693	1.000	1.000	6.000	1.250	2.205	0.945	1.760	0.315	132.8	LC..3008..

General ISO Turning

Steadyline®

MDT

Mini-Shaft™

Grooving

Parting-off

X4

Adapters
Clamping units

Accessories and
Spare parts

Workpiece
materials

General ISO Turning	Designation	Item number	INPLM	INPLX	H	B	LF	WF	LH	CDX**	Weight	CW	TQ	CTWS
			Inch	Inch	Inch	Inch	Inch	Inch	Inch	Inch	lbs	Inch	In/Lbs.	
	CFIR10008D-L9.005.50	00064888	5.512	8.976	1.000	1.000	6.000	1.250	2.205	0.945	1.760	0.315	132.8	LC..3008..
	CFIR10008D-L19.78.00	00064891	7.992	19.685	1.000	1.000	6.000	1.250	2.205	0.945	1.760	0.315	132.8	LC..3008..
	CFIL10008D-R5.003.50	00064885	3.543	5.000	1.000	1.000	6.000	1.250	2.205	0.945	1.760	0.315	132.8	LC..3008..
	CFIL10008D-R6.704.30	00064887	4.331	6.693	1.000	1.000	6.000	1.250	2.205	0.945	1.760	0.315	132.8	LC..3008..
	CFIL10008D-R9.005.50	00064889	5.512	8.976	1.000	1.000	6.000	1.250	2.205	0.945	1.760	0.315	132.8	LC..3008..
	CFIL10008D-R19.78.00	00064892	7.992	19.685	1.000	1.000	6.000	1.250	2.205	0.945	1.760	0.315	132.8	LC..3008..

Spare Parts

Steadyline®	For size	Clamp key	Clamp screw
			
MDT	.03	4SMS795	TCEI0513
	.04	5SMS795	TCEI0613
	.05	5SMS795	TCEI0613
	.06	6SMS795	TCEI0815
	.08	6SMS795	TCEI1020

Mini-Shaft™	For size	Clamp key	Clamp screw
	.03	4SMS795	TCEI0513
	.04	5SMS795	TCEI0613
	.05	5SMS795	TCEI0613
	.06	6SMS795	TCEI0815
.08	6SMS795	TCEI1020	

Grooving	For size	Clamp key	Clamp screw

Parting-off	For size	Clamp key	Clamp screw

X4	For size	Clamp key	Clamp screw

Adapters Clamping units	For size	Clamp key	Clamp screw

Accessories and Spare parts	For size	Clamp key	Clamp screw

Workpiece materials	For size	Clamp key	Clamp screw

CGIR/L – Toolholders for inserts LCGF, LCGN, LCMF and LCMR – Metric

CGIR/L
KAPR = 90,0°

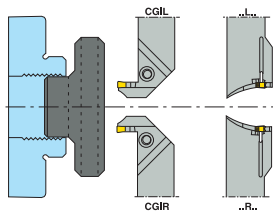
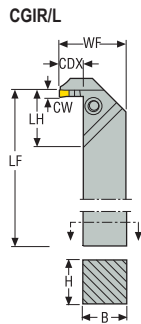
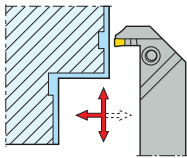

- For inserts program, see page(s) 839-844, 854-855
- Initial plunge (INPLM/INPLX) relates to face groove diameter, see page(s) 705
- CTWS = Insert shape and size
- ** Max depth of cut for LCGF/LCMF16.. = 14 mm
- CDX = 3 x CW
- Right-hand version with right-hand blade shown
- Please check availability at www.secotools.com / Seco Online Store

Designation	Item number	INPLM	INPLX	H	B	LF	WF	LH	CDX**	Weight	CW	TQ	CTWS
		mm	mm	mm	mm	mm	mm	mm	mm	kg	mm	Nm	
CGIR2525M03R100070	00035346	70	100	25	25	150	35,4	33,0	9,0	0,8	3,0	6,0	LC..1603..
CGIR2525M03R130090	00035347	90	130	25	25	150	35,4	33,0	9,0	0,8	3,0	6,0	LC..1603..
CGIR2525M03R170110	00035348	110	170	25	25	150	35,4	33,0	9,0	0,8	3,0	6,0	LC..1603..
CGIL2525M03L100070	00027656	70	100	25	25	150	35,4	33,0	9,0	0,8	3,0	6,0	LC..1603..
CGIL2525M03L130090	00027657	90	130	25	25	150	35,4	33,0	9,0	0,8	3,0	6,0	LC..1603..
CGIL2525M03L170110	00027658	110	170	25	25	150	35,4	33,0	9,0	0,8	3,0	6,0	LC..1603..
CGIR2525M04R100070	00035349	70	100	25	25	150	38,4	33,0	12,0	0,8	4,0	8,0	LC..1604..
CGIR2525M04R130090	00035350	90	130	25	25	150	38,4	33,0	12,0	0,8	4,0	8,0	LC..1604..
CGIR2525M04R170110	00035351	110	170	25	25	150	38,4	33,0	12,0	0,9	4,0	8,0	LC..1604..
CGIR2525M04R230140	00035352	140	230	25	25	150	38,4	33,0	12,0	0,8	4,0	8,0	LC..1604..
CGIL2525M04L100070	00027659	70	100	25	25	150	38,4	33,0	12,0	0,8	4,0	8,0	LC..1604..
CGIL2525M04L130090	00027660	90	130	25	25	150	38,4	33,0	12,0	0,8	4,0	8,0	LC..1604..
CGIL2525M04L170110	00027661	110	170	25	25	150	38,4	33,0	12,0	0,8	4,0	8,0	LC..1604..
CGIL2525M04L230140	00027662	140	230	25	25	150	38,4	33,0	12,0	0,8	4,0	8,0	LC..1604..
CGIR2525M05R100070	00035353	70	100	25	25	150	41,4	33,0	15,0	0,8	5,0	8,0	LC..1605..
CGIR2525M05R130090	00035354	90	130	25	25	150	41,4	33,0	15,0	0,8	5,0	8,0	LC..1605..
CGIR2525M05R170110	00035355	110	170	25	25	150	41,4	33,0	15,0	0,8	5,0	8,0	LC..1605..
CGIR2525M05R230140	00035356	140	230	25	25	150	41,4	33,0	15,0	0,8	5,0	8,0	LC..1605..
CGIL2525M05L100070	00027663	70	100	25	25	150	41,4	33,0	15,0	0,8	5,0	8,0	LC..1605..
CGIL2525M05L130090	00027664	90	130	25	25	150	41,4	33,0	15,0	0,8	5,0	8,0	LC..1605..
CGIL2525M05L170110	00027666	110	170	25	25	150	41,4	33,0	15,0	0,8	5,0	8,0	LC..1605..
CGIL2525M05L230140	00027668	140	230	25	25	150	41,4	33,0	15,0	0,8	5,0	8,0	LC..1605..
CGIR2525M06R100070	00035357	70	100	25	25	150	44,4	34,0	18,0	0,8	6,0	10,0	LC..1606..
CGIR2525M06R130090	00035358	90	130	25	25	150	44,4	34,0	18,0	0,8	6,0	10,0	LC..1606..
CGIR2525M06R170110	00035359	110	170	25	25	150	44,4	34,0	18,0	0,8	6,0	10,0	LC..1606..
CGIR2525M06R230140	00035360	140	230	25	25	150	44,4	34,0	18,0	0,8	6,0	10,0	LC..1606..
CGIL2525M06L100070	00027669	70	100	25	25	150	44,4	34,0	18,0	0,8	6,0	10,0	LC..1606..
CGIL2525M06L130090	00027670	90	130	25	25	150	44,4	34,0	18,0	0,8	6,0	10,0	LC..1606..
CGIL2525M06L170110	00027671	110	170	25	25	150	44,4	34,0	18,0	0,8	6,0	10,0	LC..1606..
CGIL2525M06L230140	00027672	140	230	25	25	150	44,4	34,0	18,0	0,8	6,0	10,0	LC..1606..

General ISO Turning

Steadyline®

MDT

Mini-Shaft™

Grooving

Parting-off

X4

Adapters
Clamping units

Accessories and
Spare parts

Workpiece
materials

	Designation	Item number	INPLM	INPLX	H	B	LF	WF	LH	CDX**	Weight	CW	TQ	CTWS
			mm	mm	mm	mm	mm	mm	mm	mm	kg	mm	Nm	
General ISO Turning	CGIR3225P08R130090	00089152	90	130	32	25	170	50,4	56,7	24,0	1,2	8,0	15,0	LC..3008..
	CGIR3225P08R170110	00089154	110	170	32	25	170	50,4	56,7	24,0	1,2	8,0	15,0	LC..3008..
	CGIR3225P08R230140	00089156	140	230	32	25	170	50,4	56,7	24,0	1,2	8,0	15,0	LC..3008..
	CGIR3225P08R500200	00089158	200	500	32	25	170	50,4	56,7	24,0	1,1	8,0	15,0	LC..3008..
	CGIL3225P08L130090	00089153	90	130	32	25	170	50,4	56,7	24,0	1,2	8,0	15,0	LC..3008..
Steadyline®	CGIL3225P08L170110	00089155	110	170	32	25	170	50,4	56,7	24,0	1,2	8,0	15,0	LC..3008..
	CGIL3225P08L230140	00089157	140	230	32	25	170	50,4	56,7	24,0	1,2	8,0	15,0	LC..3008..
	CGIL3225P08L500200	00089159	200	500	32	25	170	50,4	56,7	24,0	1,1	8,0	15,0	LC..3008..

Spare Parts

	For size	Clamp key	Clamp screw
MDT			
	CGIR/L..03	4SMS795	TCEI0513
Mini-Shaft™	CGIR/L..04	5SMS795	TCEI0613
	CGIR/L..05	5SMS795	TCEI0613
	CGIR/L..06	6SMS795	TCEI0815
	CGIR/L..08	6SMS795	TCEI1020

Grooving

Parting-off

X4

Adapters
Clamping units

Accessories and
Spare parts

Workpiece
materials

CGIR/L – Toolholders for inserts LCGF, LCGN, LCMF and LCMR – Inch

KAPR = 90,0°

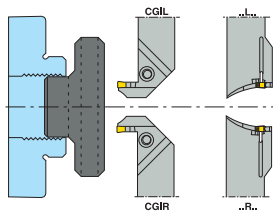
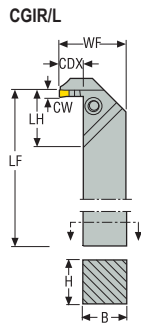
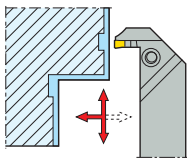

- For inserts program, see page(s) 839-844, 854-855
- Initial plunge (INPLM/INPLX) relates to face groove diameter, see page(s) 705
- CTWS = Insert shape and size
- ** Max depth of cut for LCGF/LCMF16.. = 0.551 inch
- CDX = 3 x CW
- Right-hand version with right-hand blade shown
- Please check availability at www.secotools.com / Seco Online Store

Designation	Item number	INPLM	INPLX	H	B	LF	WF	LH	CDX**	Weight	CW	TQ	CTWS
		Inch	Inch	Inch	Inch	Inch	Inch	Inch	Inch	lbs	Inch	In/Lbs.	
CGIR10003D-R4.00-2.75	00096157	2.756	3.937	1.000	1.000	6.000	1.433	1.299	0.354	1.540	0.118	53.1	LC..1603..
CGIR10003D-R5.00-3.50	00096159	3.543	5.000	1.000	1.000	6.000	1.433	1.299	0.354	1.540	0.118	53.1	LC..1603..
CGIL10003D-L4.00-2.75	00096158	2.756	3.937	1.000	1.000	6.000	1.433	1.299	0.354	1.540	0.118	53.1	LC..1603..
CGIL10003D-L5.00-3.50	00096160	3.543	5.000	1.000	1.000	6.000	1.433	1.299	0.354	1.540	0.118	53.1	LC..1603..
CGIR10004D-R4.00-2.75	00096161	2.756	3.937	1.000	1.000	6.000	1.531	1.299	0.472	1.540	0.157	70.8	LC..1604..
CGIR10004D-R5.00-3.50	00096163	3.543	5.000	1.000	1.000	6.000	1.531	1.299	0.472	1.540	0.157	70.8	LC..1604..
CGIL10004D-L4.00-2.75	00096162	2.756	3.937	1.000	1.000	6.000	1.531	1.299	0.472	1.540	0.157	70.8	LC..1604..
CGIL10004D-L5.00-3.50	00096164	3.543	5.000	1.000	1.000	6.000	1.531	1.299	0.472	1.540	0.157	70.8	LC..1604..
CGIR10006D-R5.00-3.50	00096165	3.543	5.000	1.000	1.000	6.000	1.811	1.339	0.709	1.540	0.236	88.5	LC..1606..
CGIR10006D-R6.70-4.30	00096167	4.331	6.693	1.000	1.000	6.000	1.811	1.339	0.709	1.540	0.236	88.5	LC..1606..
CGIR10006D-R9.00-5.50	00096169	5.512	8.976	1.000	1.000	6.000	1.811	1.339	0.709	1.540	0.236	88.5	LC..1606..
CGIL10006D-L5.00-3.50	00096166	3.543	5.000	1.000	1.000	6.000	1.811	1.339	0.709	1.540	0.236	88.5	LC..1606..
CGIL10006D-L6.70-4.30	00096168	4.331	6.693	1.000	1.000	6.000	1.811	1.339	0.709	1.540	0.236	88.5	LC..1606..
CGIL10006D-L9.00-5.50	00096170	5.512	8.976	1.000	1.000	6.000	1.811	1.339	0.709	1.540	0.236	88.5	LC..1606..
CGIR10008D-R5.003.50	00064875	3.543	5.000	1.000	1.000	6.000	2.004	2.165	0.945	1.540	0.315	132.8	LC..3008..
CGIR10008D-R6.704.30	00064877	4.331	6.693	1.000	1.000	6.000	2.004	2.165	0.945	1.540	0.315	132.8	LC..3008..
CGIR10008D-R9.005.50	00064879	5.512	8.976	1.000	1.000	6.000	2.004	2.165	0.945	1.540	0.315	132.8	LC..3008..
CGIR10008D-R19.78.00	00064882	7.992	19.685	1.000	1.000	6.000	2.004	2.165	0.945	1.540	0.315	132.8	LC..3008..
CGIL10008D-L9.005.50	00064881	5.512	8.976	1.000	1.000	6.000	2.004	2.165	0.945	1.540	0.315	132.8	LC..3008..
CGIL10008D-L19.78.00	00064883	7.992	19.685	1.000	1.000	6.000	2.004	2.165	0.945	1.540	0.315	132.8	LC..3008..

Spare Parts

For size	Clamp key	Clamp screw
.03	4SMS795	TCEI0513
.04	5SMS795	TCEI0613
.06	6SMS795	TCEI0815
.08	6SMS795	TCEI1020

General ISO Turning

Steadyline®

MDT

Mini-Shaft™

Grooving

Parting-off

X4

Adapters
Clamping units

Accessories and
Spare parts

Workpiece
materials

C-CG.R/L – Toolholders for inserts LCGA, LCGF, LCGN, LCMF and LCMR – Metric/ Inch



CTWS

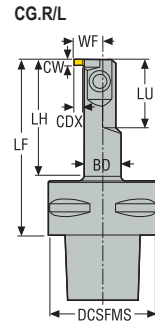

C-CG.R/L
KAPR = 90,0 °

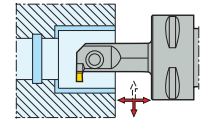



- For inserts program, see page(s) 835-837, 853
- * DCINN – minimum bore diameter, see page(s) 705
- CTMS = Seco-Capto™ size
- CTWS = Insert shape and size
- Right-hand version shown
- Please check availability at www.secotools.com / Seco Online Store

Designation	Item number	CTMS	BD	DCSFMS	WF	LF	LH	LU	CDX	DCINN*	Weight	CW	TQ	CTWS
			mm Inch	mm Inch	mm Inch	mm Inch	mm Inch	mm Inch	mm Inch	mm Inch	kg lbs	mm Inch	Nm In/Lbs.	
C4-CGER-11065-1303	00054084	C4	14,0 0.551	40,0 1.575	10,2 0.402	65 2.559	43,0 1.693	25,5 1.004	3,0 0.118	16,0 0.630	0,3 0.660	3,0 0.118	5,0 44.3	LC..1303..
C4-CGEL-11065-1303	00054080	C4	14,0 0.551	40,0 1.575	10,2 0.402	65 2.559	43,0 1.693	25,5 1.004	3,0 0.118	16,0 0.630	0,3 0.660	3,0 0.118	5,0 44.3	LC..1303..
C4-CGFR-15075-1303	00054085	C4	18,0 0.709	40,0 1.575	14,5 0.571	75 2.953	53,0 2.087	30,5 1.201	5,5 0.217	20,0 0.787	0,4 0.880	3,0 0.118	5,0 44.3	LC..1303..
C4-CGFL-15075-1303	00054083	C4	18,0 0.709	40,0 1.575	14,5 0.571	75 2.953	53,0 2.087	30,5 1.201	5,5 0.217	20,0 0.787	0,4 0.880	3,0 0.118	5,0 44.3	LC..1303..
C4-CGFR-15075-1304	00054095	C4	18,0 0.709	40,0 1.575	14,5 0.571	75 2.953	53,0 2.087	30,5 1.201	5,5 0.217	20,0 0.787	0,4 0.880	4,0 0.157	5,0 44.3	LC..1304..
C4-CGFL-15075-1304	00054094	C4	18,0 0.709	40,0 1.575	14,5 0.571	75 2.953	53,0 2.087	30,5 1.201	5,5 0.217	20,0 0.787	0,4 0.880	4,0 0.157	5,0 44.3	LC..1304..
C5-CGER-11065-1303	00054098	C5	14,0 0.551	50,0 1.969	10,2 0.402	65 2.559	43,0 1.693	25,5 1.004	3,0 0.118	16,0 0.630	0,5 1.100	3,0 0.118	5,0 44.3	LC..1303..
C5-CGEL-11065-1303	00054097	C5	14,0 0.551	50,0 1.969	10,2 0.402	65 2.559	43,0 1.693	25,5 1.004	3,0 0.118	16,0 0.630	0,5 1.100	3,0 0.118	5,0 44.3	LC..1303..
C5-CGFR-15075-1303	00054104	C5	18,0 0.709	50,0 1.969	14,5 0.571	75 2.953	53,0 2.087	30,5 1.201	5,5 0.217	20,0 0.787	0,5 1.100	3,0 0.118	5,0 44.3	LC..1303..
C5-CGFL-15075-1303	00054101	C5	18,0 0.709	50,0 1.969	14,5 0.571	75 2.953	53,0 2.087	30,5 1.201	5,5 0.217	20,0 0.787	0,5 1.100	3,0 0.118	5,0 44.3	LC..1303..
C5-CGHR-19080-1303	02718397	C5	23,0 0.906	50,0 1.969	19,0 0.748	80 3.150	58,0 2.283	40,5 1.594	7,5 0.295	25,0 0.984	0,9 1.980	3,0 0.118	5,0 44.3	LC..1303..
C5-CGHL-19080-1303	02717402	C5	23,0 0.906	50,0 1.969	19,0 0.748	80 3.150	58,0 2.283	40,5 1.594	7,5 0.295	25,0 0.984	0,9 1.980	3,0 0.118	5,0 44.3	LC..1303..
C5-CGJR-26110-1303	02718401	C5	30,0 1.181	50,0 1.969	25,5 1.004	110 4.331	88,0 3.465	50,5 1.988	10,5 0.413	32,0 1.260	0,9 1.980	3,0 0.118	5,0 44.3	LC..1303..
C5-CGJL-26110-1303	02718400	C5	30,0 1.181	50,0 1.969	25,5 1.004	110 4.331	88,0 3.465	50,5 1.988	10,5 0.413	32,0 1.260	0,9 1.980	3,0 0.118	5,0 44.3	LC..1303..
C5-CGFR-15075-1304	00054118	C5	18,0 0.709	50,0 1.969	14,5 0.571	75 2.953	53,0 2.087	30,5 1.201	5,5 0.217	20,0 0.787	0,5 1.100	4,0 0.157	5,0 44.3	LC..1304..
C5-CGFL-15075-1304	00054115	C5	18,0 0.709	50,0 1.969	14,5 0.571	75 2.953	53,0 2.087	30,5 1.201	5,5 0.217	20,0 0.787	0,5 1.100	4,0 0.157	5,0 44.3	LC..1304..
C5-CGFR-19080-1304	00054120	C5	23,0 0.906	50,0 1.969	19,0 0.748	80 3.150	58,0 2.283	40,5 1.594	7,5 0.295	25,0 0.984	0,6 1.320	4,0 0.157	5,0 44.3	LC..1304..
C5-CGFL-19080-1304	00054119	C5	23,0 0.906	50,0 1.969	19,0 0.748	80 3.150	58,0 2.283	40,5 1.594	7,5 0.295	25,0 0.984	0,6 1.320	4,0 0.157	5,0 44.3	LC..1304..
C5-CGHR-26110-1304	02718398	C5	30,0 1.181	50,0 1.969	25,5 1.004	110 4.331	88,0 3.465	50,5 1.988	10,5 0.413	32,0 1.260	0,9 1.980	4,0 0.157	5,0 44.3	LC..1304..

Designation	Item number	CTMS	BD	DCSFMS	WF	LF	LH	LU	CDX	DCINN*	Weight	CW	TQ	CTWS
			mm Inch	mm Inch	mm Inch	mm Inch	mm Inch	mm Inch	mm Inch	mm Inch	mm Inch	kg lbs	mm Inch	Nm In/Lbs.
C5-CGHL-26110-1304	02718396	C5	30,0 1.181	50,0 1.969	25,5 1.004	110 4.331	88,0 3.465	50,5 1.988	10,5 0.413	32,0 1.260	0,9 1.980	4,0 0.157	5,0 44.3	LC..1304..
C6-CGER-11065-1303	00054130	C6	14,0 0.551	63,0 2.480	10,2 0.402	65 2.559	43,0 1.693	25,5 1.004	3,0 0.118	16,0 0.630	0,8 1.760	3,0 0.118	5,0 44.3	LC..1303..
C6-CGEL-11065-1303	00054129	C6	14,0 0.551	63,0 2.480	10,2 0.402	65 2.559	43,0 1.693	25,5 1.004	3,0 0.118	16,0 0.630	0,8 1.760	3,0 0.118	5,0 44.3	LC..1303..
C6-CGFR-15075-1303	00054134	C6	18,0 0.709	63,0 2.480	14,5 0.571	75 2.953	53,0 2.087	30,5 1.201	5,5 0.217	20,0 0.787	0,9 1.980	3,0 0.118	5,0 44.3	LC..1303..
C6-CGFL-15075-1303	00054131	C6	18,0 0.709	63,0 2.480	14,5 0.571	75 2.953	53,0 2.087	30,5 1.201	5,5 0.217	20,0 0.787	0,9 1.980	3,0 0.118	5,0 44.3	LC..1303..
C6-CGHR-19080-1303	02718404	C6	23,0 0.906	63,0 2.480	19,0 0.748	80 3.150	56,0 2.205	40,5 1.594	7,5 0.295	25,0 0.984	0,6 1.320	3,0 0.118	5,0 44.3	LC..1303..
C6-CGHL-19080-1303	02718402	C6	23,0 0.906	63,0 2.480	19,0 0.748	80 3.150	58,0 2.283	40,0 1.575	7,5 0.295	25,0 0.984	0,6 1.320	3,0 0.118	5,0 44.3	LC..1303..
C6-CGJR-26110-1303	02718407	C6	30,0 1.181	63,0 2.480	25,5 1.004	110 4.331	86,0 3.386	50,0 1.969	10,5 0.413	32,0 1.260	1,1 2.430	3,0 0.118	5,0 44.3	LC..1303..
C6-CGJL-26110-1303	02718406	C6	30,0 1.181	63,0 2.480	25,5 1.004	110 4.331	86,0 3.386	50,0 1.969	10,5 0.413	32,0 1.260	1,5 3.310	3,0 0.118	5,0 44.3	LC..1303..
C6-CGFR-19080-1304	00054140	C6	23,0 0.906	63,0 2.480	19,0 0.748	80 3.150	58,0 2.283	40,5 1.594	7,5 0.295	25,0 0.984	0,9 1.980	4,0 0.157	5,0 44.3	LC..1304..
C6-CGFL-19080-1304	00054139	C6	23,0 0.906	63,0 2.480	19,0 0.748	80 3.150	58,0 2.283	40,5 1.594	7,5 0.295	25,0 0.984	0,9 1.980	4,0 0.157	5,0 44.3	LC..1304..
C6-CGHR-26110-1304	02718405	C6	30,0 1.181	63,0 2.480	25,5 1.004	110 4.331	86,0 3.386	50,5 1.988	10,5 0.413	32,0 1.260	1,1 2.430	4,0 0.157	5,0 44.3	LC..1304..
C6-CGHL-26110-1304	02718403	C6	30,0 1.181	63,0 2.480	25,5 1.004	110 4.331	88,0 3.465	50,0 1.969	10,5 0.413	32,0 1.260	1,1 2.430	4,0 0.157	5,0 44.3	LC..1304..

Spare Parts

For size	Clamp key	Clamp screw
		
CG.R/L..-1303	T15P-7	L85011-T15P
CG.R/L..-1304	T15P-7	L85011-T15P

General ISO Turning
Steadyline®
MDT
Mini-Shaft™
Grooving
Parting-off
X4
Adapters Clamping units
Accessories and Spare parts
Workpiece materials

General ISO Turning

Steadyline®

MDT

Mini-Shaft™

Grooving

Parting-off

X4

Adapters
Clamping units

Accessories and
Spare parts

Workpiece
materials

C.-CG.R/L – Toolholders for inserts LCGF, LCGN, LCMF and LCMR – Metric/ Inch



CTWS

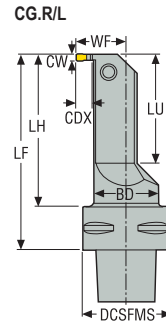

C.-CG.R/L
KAPR = 90,0 °

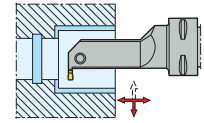

- For inserts program, see page(s) 839-852, 854-855
- * DCINN – minimum bore diameter, see page(s) 705
- CTMS = Seco-Capto™ size
- CTWS = Insert shape and size
- Right-hand version shown
- Please check availability at www.secotools.com / Seco Online Store

Designation	Item number	CTMS	BD		DCSFMS	WF	LF	LH	LU	CDX	DCINN*	Weight	CW	TQ	CTWS										
			mm	Inch																					
C4-CGIR-24090-1603	02718418	C4	30,0	1.181	40,0	1.575	24,0	0.945	90	3.543	68,0	2.677	50,3	1.980	9,0	0.354	32,0	1.260	1.100	0,5	3,0	0.118	44,3	5,0	LC..1603..
C4-CGIL-24090-1603	02718415	C4	30,0	1.181	40,0	1.575	24,0	0.945	90	3.543	68,0	2.677	50,3	1.980	9,0	0.354	32,0	1.260	1.100	0,5	3,0	0.118	44,3	5,0	LC..1603..
C4-CGGR-24090-1604	02718424	C4	30,0	1.181	40,0	1.575	24,0	0.945	90	3.543	68,0	2.677	50,3	1.980	9,0	0.354	32,0	1.260	1.100	4,0	0.157	44,3	5,0	LC..1604..	
C4-CGGL-24090-1604	02718421	C4	30,0	1.181	40,0	1.575	24,0	0.945	90	3.543	68,0	2.677	50,3	1.980	9,0	0.354	32,0	1.260	1.100	4,0	0.157	44,3	5,0	LC..1604..	
C5-CGIR-24090-1603	02718419	C5	30,0	1.181	50,0	1.969	24,0	0.945	90	3.543	68,0	2.677	50,3	1.980	9,0	0.354	32,0	1.260	1.980	0,9	3,0	0.118	44,3	5,0	LC..1603..
C5-CGIL-24090-1603	02718416	C5	30,0	1.181	50,0	1.969	24,0	0.945	90	3.543	68,0	2.677	50,3	1.980	9,0	0.354	32,0	1.260	1.980	0,9	3,0	0.118	44,3	5,0	LC..1603..
C5-CGGR-24090-1604	02718425	C5	30,0	1.181	50,0	1.969	24,0	0.945	90	3.543	68,0	2.677	49,9	1.965	9,0	0.354	32,0	1.260	1.980	0,9	4,0	0.157	44,3	5,0	LC..1604..
C5-CGGL-24090-1604	02718422	C5	30,0	1.181	50,0	1.969	24,0	0.945	90	3.543	68,0	2.677	49,9	1.965	9,0	0.354	32,0	1.260	1.980	0,9	4,0	0.157	44,3	5,0	LC..1604..
C5-CGFR-24090-1605	02718431	C5	30,0	1.181	50,0	1.969	24,0	0.945	90	3.543	68,0	2.677	49,9	1.965	9,0	0.354	32,0	1.260	1.980	0,9	5,0	0.197	53,1	6,0	LC..1605..
C5-CGFL-24090-1605	02718428	C5	30,0	1.181	50,0	1.969	24,0	0.945	90	3.543	68,0	2.677	49,9	1.965	9,0	0.354	32,0	1.260	1.980	0,9	5,0	0.197	53,1	6,0	LC..1605..
C5-CGFR-24090-1606	02718435	C5	30,0	1.181	50,0	1.969	24,0	0.945	90	3.543	68,0	2.677	49,9	1.965	9,0	0.354	32,0	1.260	1.980	0,9	6,0	0.236	53,1	6,0	LC..1606..
C5-CGFL-24090-1606	02718433	C5	30,0	1.181	50,0	1.969	24,0	0.945	90	3.543	68,0	2.677	49,9	1.965	9,0	0.354	32,0	1.260	1.980	0,9	6,0	0.236	53,1	6,0	LC..1606..
C6-CGIR-24095-1603	02718420	C6	30,0	1.181	63,0	2.480	24,0	0.945	95	3.740	73,0	2.874	50,3	1.980	9,0	0.354	32,0	1.260	3.310	1,5	3,0	0.118	44,3	5,0	LC..1603..
C6-CGIL-24095-1603	02718417	C6	30,0	1.181	63,0	2.480	24,0	0.945	95	3.740	73,0	2.874	50,3	1.980	9,0	0.354	32,0	1.260	3.310	1,5	3,0	0.118	44,3	5,0	LC..1603..
C6-CGGR-24095-1604	02718426	C6	30,0	1.181	63,0	2.480	24,0	0.945	95	3.740	73,0	2.874	50,3	1.980	9,0	0.354	32,0	1.260	3.310	4,0	0.157	44,3	5,0	LC..1604..	
C6-CGGL-24095-1604	02718423	C6	30,0	1.181	63,0	2.480	24,0	0.945	95	3.740	73,0	2.874	50,3	1.980	9,0	0.354	32,0	1.260	3.310	4,0	0.157	44,3	5,0	LC..1604..	
C6-CGFR-24095-1605	02718432	C6	30,0	1.181	63,0	2.480	24,0	0.945	95	3.740	73,0	2.874	50,3	1.980	9,0	0.354	32,0	1.260	3.310	1,5	5,0	0.197	53,1	6,0	LC..1605..
C6-CGFL-24095-1605	02718429	C6	30,0	1.181	63,0	2.480	24,0	0.945	95	3.740	73,0	2.874	50,3	1.980	9,0	0.354	32,0	1.260	3.310	1,5	5,0	0.197	53,1	6,0	LC..1605..

Designation	Item number	CTMS	BD	DCSFMS	WF	LF	LH	LU	CDX	DCINN*	Weight	CW	TQ	CTWS
			mm Inch	mm Inch	mm Inch	mm Inch	mm Inch	mm Inch	mm Inch	mm Inch	kg lbs	mm Inch	Nm In/Lbs.	
CG-CGFR-24095-1606	02718436	C6	30,0 1.181	63,0 2.480	24,0 0.945	95 3.740	73,0 2.874	50,3 1.980	9,0 0.354	32,0 1.260	1,5 3.310	6,0 0.236	6,0 53.1	LC..1606..
CG-CGFL-24095-1606	02718434	C6	30,0 1.181	63,0 2.480	24,0 0.945	95 3.740	73,0 2.874	50,3 1.980	9,0 0.354	32,0 1.260	1,5 3.310	6,0 0.236	6,0 53.1	LC..1606..

Spare Parts

For size	Clamp key	Clamp screw
		
CG.R/L...-1603	T15P-7	L85011-T15P
CG.R/L...-1604	T15P-7	L85011-T15P
CG.R/L...-1605	T20P-7	L86015-T20P
CG.R/L...-1606	T20P-7	L86015-T20P

General ISO Turning

Steadyline®

MDT

Mini-Shaft™

Grooving

Parting-off

X4

Adapters
Clamping units

Accessories and
Spare parts

Workpiece
materials

General ISO Turning

C.-CG.R/L – Toolholders for inserts LCMF – Metric/ Inch

Steadyline®



CTWS

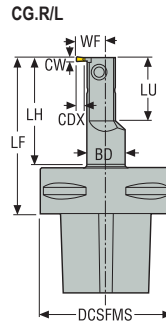

C.-CG.R/L
KAPR = 90,0 °

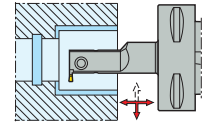

- For inserts program, see page(s) 838
- * DCINN – minimum bore diameter, see page(s) 705
- CTMS = Seco-Capto™ size
- CTWS = Insert shape and size
- Right-hand version shown
- Please check availability at www.secotools.com / Seco Online Store

MDT

Mini-Shaft™

Designation	Item number	CTMS	BD		DCSFMS	WF	LF	LH	LU	CDX	DCINN*	Weight	CW	TQ	CTWS										
			mm	Inch																					
C4-CGHR-15075-1902	02749181	C4	18,0	0.709	40,0	1.575	14,5	0.571	75	2.953	53,0	2.087	30,5	1.201	5,5	0.217	20,0	0.787	0,4	0.880	2,0	0.079	5,0	44.3	LC..1902..
C4-CGHL-15075-1902	02749187	C4	18,0	0.709	40,0	1.575	14,5	0.571	75	2.953	53,0	2.087	30,5	1.201	5,5	0.217	20,0	0.787	0,4	0.880	2,0	0.079	5,0	44.3	LC..1902..
C5-CGHR-15075-1902	02749182	C5	18,0	0.709	50,0	1.969	14,5	0.571	75	2.953	53,0	2.087	30,5	1.201	5,5	0.217	20,0	0.787	0,5	1.100	2,0	0.079	5,0	44.3	LC..1902..
C5-CGHL-15075-1902	02749188	C5	18,0	0.709	50,0	1.969	14,5	0.571	75	2.953	53,0	2.087	30,5	1.201	5,5	0.217	20,0	0.787	0,5	1.100	2,0	0.079	5,0	44.3	LC..1902..
C6-CGHR-15075-1902	02749183	C6	18,0	0.709	60,0	2.362	14,5	0.571	75	2.953	51,0	2.008	30,5	1.201	5,5	0.217	20,0	0.787	0,9	1.980	2,0	0.079	5,0	44.3	LC..1902..
C6-CGHL-15075-1902	02749189	C6	18,0	0.709	60,0	2.362	14,5	0.571	75	2.953	51,0	2.008	30,5	1.201	5,5	0.217	20,0	0.787	0,9	1.980	2,0	0.079	5,0	44.3	LC..1902..
C4-CGJR-19080-1902	02749184	C4	23,0	0.906	40,0	1.575	19,0	0.748	80	3.150	58,0	2.283	30,5	1.201	7,5	0.295	25,0	0.984	0,4	0.880	2,0	0.079	5,0	44.3	LC..1902..
C4-CGJL-19080-1902	02749190	C4	23,0	0.906	40,0	1.575	19,0	0.748	80	3.150	58,0	2.283	30,5	1.201	7,5	0.295	25,0	0.984	0,4	0.880	2,0	0.079	5,0	44.3	LC..1902..
C5-CGJR-19080-1902	02749185	C5	23,0	0.906	50,0	1.969	19,0	0.748	80	3.150	58,0	2.283	30,5	1.201	7,5	0.295	25,0	0.984	0,6	1.320	2,0	0.079	5,0	44.3	LC..1902..
C5-CGJL-19080-1902	02749191	C5	23,0	0.906	50,0	1.969	19,0	0.748	80	3.150	58,0	2.283	30,5	1.201	7,5	0.295	25,0	0.984	0,6	1.320	2,0	0.079	5,0	44.3	LC..1902..
C6-CGJR-19080-1902	02749186	C6	23,0	0.906	60,0	2.362	19,0	0.748	80	3.150	56,0	2.205	30,5	1.201	7,5	0.295	25,0	0.984	0,9	1.980	2,0	0.079	5,0	44.3	LC..1902..
C6-CGJL-19080-1902	02749192	C6	23,0	0.906	60,0	2.362	19,0	0.748	80	3.150	56,0	2.205	30,5	1.201	7,5	0.295	25,0	0.984	0,9	1.980	2,0	0.079	5,0	44.3	LC..1902..

Grooving

Parting-off

X4

Adapters
Clamping units

Spare Parts

Accessories and
Spare parts

For size	Clamp key	Clamp screw
CG.R/L...1902	T15P-7	L85011-T15P

Workpiece
materials

C.-CGGR/L – Toolholders for inserts LCGF, LCGN, LCMF and LCMR – Metric / Inch

C.-CGGR/L
KAPR = 90,0°

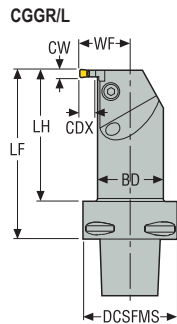
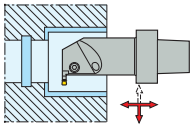

- For inserts program, see page(s) 839-852, 854-855
- * DCINN – minimum bore diameter, see page(s) 705
- CTMS = Seco-Capto™ size
- CTWS = Insert shape and size
- CDX = 2 x CW
- Right-hand version shown
- Please check availability at www.secotools.com / Seco Online Store

Designation	Item number	CTMS	BD	DCSFMS	WF	LF	LH	CDX	DCINN*	Weight	CW	TQ	CTWS
			mm Inch	mm Inch	mm Inch	mm Inch	mm Inch	mm Inch	mm Inch		mm Inch	kg lbs	
C4-CGGR-25090-03	00038031	C4	35,0 1.378	40,0 1.575	25,0 0.984	90 3.543	70,0 2.756	6,0 0.236	45,0 1.772	0,7 1.540	3,0 0.118	3,5 31.0	LC..1603..
C4-CGGL-25090-03	00038030	C4	35,0 1.378	40,0 1.575	25,0 0.984	90 3.543	70,0 2.756	6,0 0.236	45,0 1.772	0,7 1.540	3,0 0.118	3,5 31.0	LC..1603..
C4-CGGR-27090-04	00038037	C4	35,0 1.378	40,0 1.575	27,0 1.063	90 3.543	70,0 2.756	8,0 0.315	45,0 1.772	0,7 1.540	4,0 0.157	5,0 44.3	LC..1604..
C4-CGGL-27090-04	00038036	C4	35,0 1.378	40,0 1.575	27,0 1.063	90 3.543	70,0 2.756	8,0 0.315	45,0 1.772	0,7 1.540	4,0 0.157	5,0 44.3	LC..1604..
C4-CGGR-28090-05	02718413	C4	32,5 1.280	40,0 1.575	27,7 1.091	90 3.543	63,0 2.480	10,0 0.394	45,0 1.772	0,5 1.100	5,0 0.197	5,0 44.3	LC..1605..
C4-CGGL-28090-05	02718408	C4	32,5 1.280	40,0 1.575	27,7 1.091	90 3.543	63,0 2.480	10,0 0.394	45,0 1.772	0,5 1.100	5,0 0.197	5,0 44.3	LC..1605..
C5-CGGR-25090-03	00038033	C5	35,0 1.378	50,0 1.969	25,0 0.984	90 3.543	70,0 2.756	6,0 0.236	45,0 1.772	0,9 1.980	3,0 0.118	3,5 31.0	LC..1603..
C5-CGGL-25090-03	00038032	C5	35,0 1.378	50,0 1.969	25,0 0.984	90 3.543	70,0 2.756	6,0 0.236	45,0 1.772	0,9 1.980	3,0 0.118	3,5 31.0	LC..1603..
C5-CGGR-27090-04	00038039	C5	35,0 1.378	50,0 1.969	27,0 1.063	90 3.543	70,0 2.756	8,0 0.315	45,0 1.772	0,9 1.980	4,0 0.157	5,0 44.3	LC..1604..
C5-CGGL-27090-04	00038038	C5	35,0 1.378	50,0 1.969	27,0 1.063	90 3.543	70,0 2.756	8,0 0.315	45,0 1.772	0,9 1.980	4,0 0.157	5,0 44.3	LC..1604..
C5-CGGR-28090-05	00071960	C5	32,5 1.280	50,0 1.969	27,7 1.091	90 3.543	63,0 2.480	10,0 0.394	45,0 1.772	0,9 1.980	5,0 0.197	5,0 44.3	LC..1605..
C5-CGGL-28090-05	02718414	C5	32,5 1.280	50,0 1.969	27,7 1.091	90 3.543	63,0 2.480	10,0 0.394	45,0 1.772	0,9 1.980	5,0 0.197	5,0 44.3	LC..1605..
C5-CGGR-29090-06	02719020	C5	30,5 1.201	50,0 1.969	28,7 1.130	90 3.543	62,0 2.441	12,0 0.472	45,0 1.772	0,9 1.980	6,0 0.236	8,0 70.8	LC..1606..
C5-CGGL-29090-06	02719019	C5	30,5 1.201	50,0 1.969	28,7 1.130	90 3.543	62,0 2.441	12,0 0.472	45,0 1.772	0,9 1.980	6,0 0.236	8,0 70.8	LC..1606..
C6-CGGR-25095-03	00038035	C6	35,0 1.378	63,0 2.480	25,0 0.984	95 3.740	73,0 2.874	6,0 0.236	45,0 1.772	1,2 2.650	3,0 0.118	3,5 31.0	LC..1603..
C6-CGGL-25095-03	00038034	C6	35,0 1.378	63,0 2.480	25,0 0.984	95 3.740	73,0 2.874	6,0 0.236	45,0 1.772	1,2 2.650	3,0 0.118	3,5 31.0	LC..1603..
C6-CGGR-27095-04	00038041	C6	35,0 1.378	63,0 2.480	27,0 1.063	95 3.740	73,0 2.874	8,0 0.315	45,0 1.772	1,2 2.650	4,0 0.157	5,0 44.3	LC..1604..
C6-CGGL-27095-04	00038040	C6	35,0 1.378	63,0 2.480	27,0 1.063	95 3.740	73,0 2.874	8,0 0.315	45,0 1.772	1,2 2.650	4,0 0.157	5,0 44.3	LC..1604..
C6-CGGR-28095-05	00071964	C6	32,5 1.280	63,0 2.480	27,7 1.091	95 3.740	68,0 2.677	10,0 0.394	45,0 1.772	1,3 2.870	5,0 0.197	5,0 44.3	LC..1605..

General ISO Turning

Steadyline®

MDT

Mini-Shaft™

Grooving

Parting-off

X4

Adapters
Clamping units

Accessories and
Spare parts

Workpiece
materials

Designation	Item number	CTMS	BD	DCSFMS	WF	LF	LH	CDX	DCINN*	Weight	CW	TQ	CTWS
			mm Inch	mm Inch	mm Inch	mm Inch	mm Inch	mm Inch	mm Inch	mm Inch	kg lbs	mm Inch	Nm In/Lbs.
C6-CGGL-28095-05	00071963	C6	32,5 1.280	63,0 2.480	27,7 1.091	95 3.740	68,0 2.677	10,0 0.394	45,0 1.772	1,3 2.870	5,0 0.197	5,0 44.3	LC..1605..
C6-CGGR-29095-06	00070149	C6	30,5 1.201	63,0 2.480	28,7 1.130	95 3.740	67,0 2.638	12,0 0.472	45,0 1.772	1,4 3.090	6,0 0.236	8,0 70.8	LC..1606..
C6-CGGL-29095-06	00044935	C6	30,5 1.201	63,0 2.480	28,7 1.130	95 3.740	67,0 2.638	12,0 0.472	45,0 1.772	1,4 3.090	6,0 0.236	8,0 70.8	LC..1606..

Spare Parts

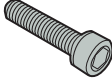
For size	Clamp key	Clamp screw
		
CG.R/L...03	3SMS795	MC6S4X14
CG.R/L...04	4SMS795	MC6S5X14
CG.R/L...05	4SMS795	MC6S5X14
CG.R/L...06	5SMS795	TCEI0614

- General ISO Turning
- Steadyline®
- MDT
- Mini-Shaft™
- Grooving
- Parting-off
- X4
- Adapters
Clamping units
- Accessories and
Spare parts
- Workpiece
materials

CG.R/L – Toolholders for inserts LCGA, LCGF, LCGN, LCMF and LCMR – Metric

CG.R/L
KAPR = 90,0°

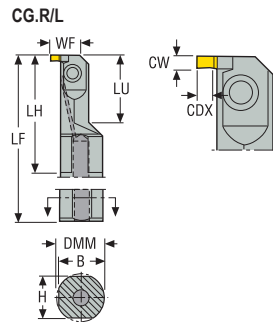
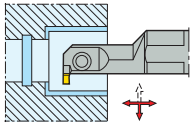

- For inserts program, see page(s) 835-837, 853
- * DCINN – minimum bore diameter, see page(s) 705
- CTWS = Insert shape and size
- Right-hand version shown
- Please check availability at www.secotools.com / Seco Online Store

Designation	Item number	DMM	H	B	LF	LH	LU	WF	CDX**	DCINN*	Weight	CW	TQ	CTWS
		mm	mm	mm	mm	mm	mm	mm	mm	mm	kg	mm	Nm	
A16Q-CGER1303	00053891	16	15	15,5	180	40,0	25,0	10,2	3,0	16,0	0,3	3,0	5,0	LC..1303..
A16Q-CGEL1303	00053890	16	15	15,5	180	40,0	25,0	10,2	3,0	16,0	0,3	3,0	5,0	LC..1303..
A20R-CGFR1303	00053893	20	18	19,0	200	52,0	30,0	14,5	5,5	20,0	0,4	3,0	5,0	LC..1303..
A20R-CGFL1303	00053892	20	18	19,0	200	52,0	30,0	14,5	5,5	20,0	0,4	3,0	5,0	LC..1303..
A25S-CGHR1303	00053895	25	23	24,0	250	64,0	40,0	19,0	7,5	25,0	0,8	3,0	5,0	LC..1303..
A25S-CGHL1303	00053894	25	23	24,0	250	64,0	40,0	19,0	7,5	25,0	0,8	3,0	5,0	LC..1303..
A32T-CGJR1303	00053910	32	30	31,0	300	77,0	50,0	25,5	10,5	32,0	1,6	3,0	5,0	LC..1303..
A32T-CGJL1303	00053900	32	30	31,0	300	77,0	50,0	25,5	10,5	32,0	1,6	3,0	5,0	LC..1303..
A20R-CGFR1304	00053950	20	18	19,0	200	52,0	30,0	14,5	5,5	20,0	0,4	4,0	5,0	LC..1304..
A20R-CGFL1304	00053945	20	18	19,0	200	52,0	30,0	14,5	5,5	20,0	0,4	4,0	5,0	LC..1304..
A25S-CGFR1304	00053965	25	23	24,0	250	64,0	40,0	19,0	7,5	25,0	0,8	4,0	5,0	LC..1304..
A25S-CGFL1304	00053963	25	23	24,0	250	64,0	40,0	19,0	7,5	25,0	0,8	4,0	5,0	LC..1304..
A32T-CGHR1304	00077780	32	30	31,0	300	77,0	50,0	25,5	10,5	32,0	1,6	4,0	5,0	LC..1304..
A32T-CGHL1304	00053966	32	30	31,0	300	77,0	50,0	25,5	10,5	32,0	1,6	4,0	5,0	LC..1304..

Spare Parts

For size	Clamp key	Clamp screw
		
A16Q..	T15P-7	L85011-T15P
A20R..	T15P-7	L85011-T15P
A25S..	T15P-7	L85011-T15P
A32T..	T15P-7	L85011-T15P

General ISO Turning

Steadyline®

MDT

Mini-Shaft™

Grooving

Parting-off

X4

Adapters
Clamping units

Accessories and
Spare parts

Workpiece
materials

General ISO Turning

CG.R/L – Toolholders for inserts LCGA, LCGF, LCGN, LCMF and LCMR – Inch

Steadyline®

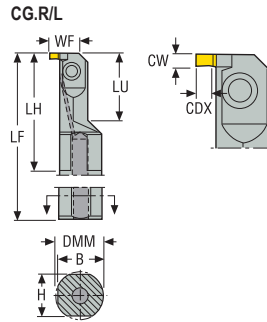

KAPR = 90,0 °

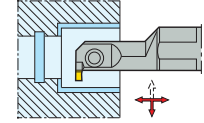

CTWS



- For inserts program, see page(s) 835-837, 853
- * DCINN – minimum bore diameter, see page(s) 705
- CTWS = Insert shape and size
- Right-hand version shown
- Please check availability at www.secotools.com / Seco Online Store

MDT

Mini-Shaft™

Designation	Item number	DMM	H	B	LF	LH	LU	WF	CDX**	DCINN*	Weight	CW	TQ	CTWS
		Inch	Inch	Inch	Inch	Inch	Inch	Inch	Inch	Inch	lbs	Inch	In/Lbs.	
A10-CGER1303	00061858	0.625	0.586	0.605	7.000	1.620	0.984	0.400	0.118	0.630	0.660	0.118	44.3	LC..1303..
A10-CGEL1303	00061859	0.625	0.586	0.605	7.000	1.620	0.984	0.400	0.118	0.630	0.660	0.118	44.3	LC..1303..
A12-CGFR1303	00061863	0.750	0.671	0.711	8.000	2.010	1.181	0.570	0.216	0.790	0.880	0.118	44.3	LC..1303..
A12-CGFL1303	00061865	0.750	0.671	0.711	8.000	2.010	1.181	0.570	0.216	0.790	0.880	0.118	44.3	LC..1303..
A16-CGHR1303	00061868	1.000	0.921	0.961	10.000	2.600	1.575	0.750	0.295	0.985	1.540	0.118	44.3	LC..1304..
A16-CGHL1303	00061869	1.000	0.921	0.961	10.000	2.600	1.575	0.750	0.295	0.985	1.540	0.118	44.3	LC..1304..
A20-CGJR1303	00061870	1.250	1.171	1.211	12.000	3.090	1.969	1.000	0.413	1.260	3.530	0.118	44.3	LC..1304..
A20-CGJL1303	00061871	1.250	1.171	1.211	12.000	3.090	1.969	1.000	0.413	1.260	3.530	0.118	44.3	LC..1304..
A12-CGFR1304	00061866	0.750	0.671	0.711	8.000	2.010	1.181	0.570	0.216	0.790	1.100	0.157	44.3	LC..1304..
A12-CGFL1304	00061867	0.750	0.671	0.711	8.000	2.010	1.181	0.570	0.216	0.790	1.100	0.157	44.3	LC..1304..
A16-CGFR1304	00055598	1.000	0.921	0.961	10.000	2.600	1.575	0.750	0.295	0.985	1.540	0.157	44.3	LC..1304..
A16-CGFL1304	00055604	1.000	0.921	0.961	10.000	2.600	1.575	0.750	0.295	0.985	1.760	0.157	44.3	LC..1304..
A20-CGHR1304	00061873	1.250	1.171	1.211	12.000	3.090	1.969	1.000	0.413	1.260	3.530	0.157	44.3	LC..1304..
A20-CGHL1304	00061875	1.250	1.171	1.211	12.000	3.090	1.969	1.000	0.413	1.260	3.310	0.157	44.3	LC..1304..

Grooving

Parting-off

X4

Spare Parts

For size	Clamp key	Clamp screw
A10..	 T15P-7	 L85011-T15P
A12..	T15P-7	L85011-T15P
A16..	T15P-7	L85011-T15P
A20..	T15P-7	L85011-T15P

Adapters
Clamping units

Accessories and
Spare parts

Workpiece
materials

CG.R/L – Toolholders for inserts LCGF, LCGN, LCMF and LCMR – Metric

CG.R/L
KAPR = 90,0°

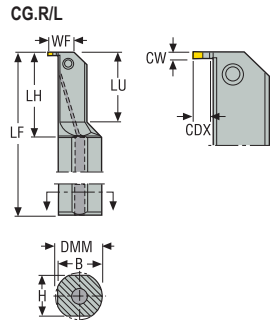
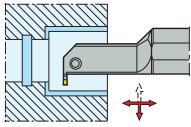

- For inserts program, see page(s) 839–852, 854–855
- * DCINN – minimum bore diameter, see page(s) 705
- CTWS = Insert shape and size
- Right-hand version shown
- Please check availability at www.secotools.com / Seco Online Store

Designation	Item number	DMM	H	B	LF	LH	LU	WF	CDX**	DCINN*	Weight	CW	TQ	CTWS
		mm	mm	mm	mm	mm	mm	mm	mm	mm	kg	mm	Nm	
A32T-CGIR1603	02717661	32	30	31,0	300	60,0	50,0	24,0	9,0	32,0	1,6	3,0	5,0	LC..1603..
A32T-CGIL1603	02718385	32	30	31,0	300	60,0	50,0	24,0	9,0	32,0	1,6	3,0	5,0	LC..1603..
A32T-CGGR1604	02718382	32	30	31,0	300	60,0	50,0	24,0	9,0	32,0	1,6	4,0	5,0	LC..1604..
A32T-CGGL1604	02718386	32	30	31,0	300	60,0	50,0	24,0	9,0	32,0	1,6	4,0	5,0	LC..1604..
A32T-CGFR1605	02718383	32	30	31,0	300	60,0	50,0	24,0	9,0	32,0	1,6	5,0	6,0	LC..1605..
A32T-CGFL1605	02718387	32	30	31,0	300	60,0	50,0	24,0	9,0	32,0	1,6	5,0	6,0	LC..1605..
A32T-CGFR1606	02718384	32	30	31,0	300	60,0	50,0	24,0	9,0	32,0	1,6	6,0	6,0	LC..1606..
A32T-CGFL1606	02718388	32	30	31,0	300	60,0	50,0	24,0	9,0	32,0	1,6	6,0	6,0	LC..1606..

Spare Parts

For size	Clamp key	Clamp screw
CG.R/L..03	 T15P-7	 L85011-T15P
CG.R/L..04	T15P-7	L85011-T15P
CG.R/L..05	T20P-7	L86015-T20P
CG.R/L..06	T20P-7	L86015-T20P

General ISO Turning

Steadyline®

MDT

Mini-Shaft™

Grooving

Parting-off

X4

Adapters
Clamping units

Accessories and
Spare parts

Workpiece
materials

General ISO Turning

CG.R/L – Toolholders for inserts LCGF, LCGN, LCMF and LCMR – Inch

Steadyline®

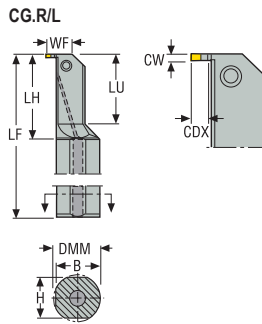

KAPR = 90,0 °

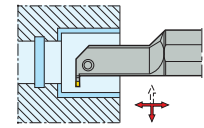

CTWS



- For inserts program, see page(s) 839–852, 854–855
- * DCINN – minimum bore diameter, see page(s) 705
- CTWS = Insert shape and size
- Right-hand version shown
- Please check availability at www.secotools.com / Seco Online Store

MDT

Mini-Shaft™

Designation	Item number	DMM	H	B	LF	LH	LU	WF	CDX**	DCINN*	Weight	CW	TQ	CTWS
		Inch	Inch	Inch	Inch	Inch	Inch	Inch	Inch	Inch	lbs	Inch	In/Lbs.	
A20-CGIR03	02717401	1.250	1.171	1.211	12.000	2.362	1.969	0.929	0.354	1.260	3.530	0.118	44.3	LC..1603..
A20-CGIL03	02718392	1.250	1.171	1.211	12.000	2.362	1.969	0.929	0.354	1.260	3.530	0.118	44.3	LC..1603..
A20-CGGR04	02718389	1.250	1.171	1.211	12.000	2.362	1.969	0.929	0.394	1.260	3.530	0.157	44.3	LC..1604..
A20-CGGL04	02718393	1.250	1.171	1.211	12.000	2.362	1.969	0.929	0.394	1.260	3.530	0.157	44.3	LC..1604..
A20-CGFR05	02718390	1.250	1.171	1.211	12.000	2.362	1.969	0.929	0.295	1.260	3.530	0.197	53.1	LC..1605..
A20-CGFL05	02718394	1.250	1.171	1.211	12.000	2.362	1.969	0.929	0.295	1.260	3.530	0.197	53.1	LC..1605..
A20-CGFR06	02718391	1.250	1.171	1.211	12.000	2.362	1.969	0.929	0.295	1.260	3.310	0.236	53.1	LC..1606..
A20-CGFL06	02718395	1.250	1.171	1.211	12.000	2.362	1.969	0.929	0.295	1.260	3.310	0.236	53.1	LC..1606..

Grooving

Parting-off

Spare Parts

For size	Clamp key	Clamp screw
..03	 T15P-7	 L85011-T15P
..04	T15P-7	L85011-T15P
..05	T20P-7	L86015-T20P
..06	T20P-7	L86015-T20P

Adapters
Clamping units

Accessories and
Spare parts

Workpiece
materials

CGGR/L – Toolholders for inserts LCGF, LCGN, LCMF and LCMR – Metric

CGGR/L
KAPR = 90,0°

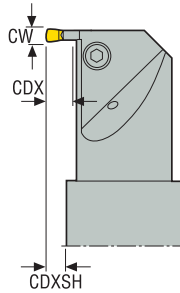
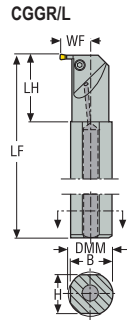
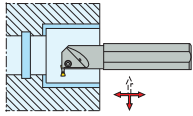

- For inserts program, see page(s) 839-852, 854-855
- * DCINN – minimum bore diameter, see page(s) 705
- CTWS = Insert shape and size
- ** If toolholder enters bore more than LH
- CDX = 2 x CW
- Right-hand version shown
- Please check availability at www.secotools.com / Seco Online Store

Designation	Item number	DMM	H	B	LF	LH	WF	CDX**	CDXSH**	DCINN*	Weight	CW	TQ	CTWS
		mm	mm	mm	mm	mm	mm	mm	mm	mm	kg	mm	Nm	
A40T-CGGR03	00093896	40	37	39	300	60,0	26,0	6,0	5,5	45,0	2,5	3,0	3,5	LC..1603..
A40T-CGGL03	00093897	40	37	39	300	60,0	26,0	6,0	5,5	45,0	2,5	3,0	3,5	LC..1603..
A40T-CGGR04	00093898	40	37	39	300	60,0	27,0	8,0	6,5	45,0	2,4	4,0	5,0	LC..1604..
A40T-CGGL04	00093899	40	37	39	300	60,0	27,0	8,0	6,5	45,0	2,4	4,0	5,0	LC..1604..
A40T-CGGR05	00013456	40	37	39	300	60,0	28,0	10,0	7,5	45,0	2,4	5,0	5,0	LC..1605..
A40T-CGGL05	00013454	40	37	39	300	60,0	28,0	10,0	7,5	45,0	2,4	5,0	5,0	LC..1605..
A40T-CGGR06	00013458	40	37	39	300	60,0	29,0	12,0	8,5	45,0	2,4	6,0	8,0	LC..1606..
A40T-CGGL06	00013457	40	37	39	300	60,0	29,0	12,0	8,5	45,0	2,4	6,0	8,0	LC..1606..

Spare Parts

For size	Clamp key	Clamp screw
-.03	3SMS795	MC6S4X14
-.04	4SMS795	MC6S5X14
-.05	4SMS795	MC6S5X14
-.06	5SMS795	TCEI0614

General ISO Turning

Steadyline®

MDT

Mini-Shaft™

Grooving

Parting-off

X4

Adapters
Clamping units

Accessories and
Spare parts

Workpiece
materials

General ISO Turning

Steadyline®

MDT

Mini-Shaft™

Grooving

Parting-off

X4

Adapters
Clamping units

Accessories and
Spare parts

Workpiece
materials

CGGR/L – Toolholders for inserts LCGF, LCGN, LCMF and LCMR – Inch

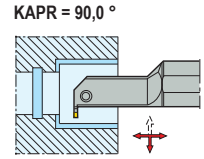
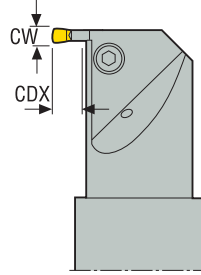
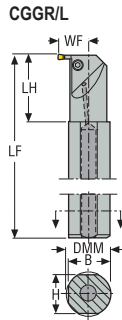

- For inserts program, see page(s) 839-852, 854-855
- * DCINN – minimum bore diameter, see page(s) 705
- CTWS = Insert shape and size
- CDX = 2 x CW
- Right-hand version shown
- Please check availability at www.secotools.com / Seco Online Store

Designation	Item number	DMM	H	B	LF	LH	WF	CDX**	DCINN*	Weight	CW	TQ	CTWS
		Inch	Inch	Inch	Inch	Inch	Inch	Inch	Inch	lbs	Inch	In/Lbs.	
A24-CGGR03	00003293	1.500	1.382	1.429	12.000	2.362	1.126	0.440	1.800	5.510	0.118	31.0	LC..1603..
A24-CGGL03	00003294	1.500	1.382	1.429	12.000	2.362	1.126	0.440	1.800	5.510	0.118	31.0	LC..1603..
A24-CGGR04	00003296	1.500	1.382	1.429	12.000	2.362	1.126	0.440	1.800	5.510	0.157	44.3	LC..1604..
A24-CGGL04	00003297	1.500	1.382	1.429	12.000	2.362	1.126	0.440	1.800	5.510	0.157	44.3	LC..1604..
A24-CGGR05	00059841	1.500	1.382	1.429	12.000	2.362	1.091	0.440	1.800	5.510	0.197	44.3	LC..1605..
A24-CGGL05	00059842	1.500	1.382	1.429	12.000	2.362	1.091	0.440	1.800	5.510	0.197	44.3	LC..1605..
A24-CGGR06	00059843	1.500	1.382	1.429	12.000	2.362	1.130	0.515	1.800	5.510	0.236	44.3	LC..1606..
A24-CGGL06	00059844	1.500	1.382	1.429	12.000	2.362	1.130	0.515	1.800	5.510	0.236	44.3	LC..1606..

Spare Parts

For size	Clamp key	Clamp screw
..03	3SMS795	MC6S4X14
..04	4SMS795	MC6S5X14
..05	4SMS795	MC6S5X14
..06	5SMS795	TCEI0614

CG.R/L – Toolholders for inserts LCMF – Metric

CG.R/L
KAPR = 90,0 °

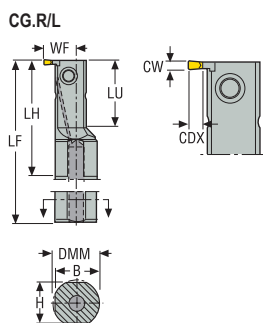
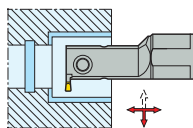

CTWS



- For inserts program, see page(s) 838
- * DCINN – minimum bore diameter, see page(s) 705
- CTWS = Insert shape and size
- Right-hand version shown
- Please check availability at www.secotools.com / Seco Online Store

Designation	Item number	DMM	H	B	LF	LH	LU	WF	CDX**	DCINN*	Weight	CW	TQ	CTWS
		mm	mm	mm	mm	mm	mm	mm	mm	mm	kg	mm	Nm	
A20R-CGHR1902	02748762	20	18	19,0	200	52,0	30,0	14,5	5,5	20,0	0,4	2,0	5,0	LC..1902..
A20R-CGHL1902	02748763	20	18	19,0	200	52,0	30,0	14,5	5,5	20,0	0,4	2,0	5,0	LC..1902..
A25S-CGJR1902	02748765	25	23	24,0	250	64,0	40,0	19,0	7,5	25,0	0,8	2,0	5,0	LC..1902..
A25S-CGJL1902	02748766	25	23	24,0	250	64,0	40,0	19,0	7,5	25,0	0,8	2,0	5,0	LC..1902..

Spare Parts

For size	Clamp key	Clamp screw
A20-..	 T15P-7	 L85011-T15P
A25-..	T15P-7	L85011-T15P

General ISO Turning

Steadyline®

MDT

Mini-Shaft™

Grooving

Parting-off

X4

Adapters
Clamping units

Accessories and
Spare parts

Workpiece
materials

General ISO Turning

CG.R/L – Toolholders for inserts LCGA, LCGF, LCGN, LCMF and LCMR – Inch

Steadyline®

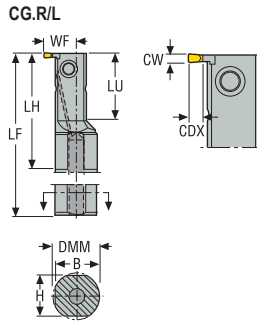

KAPR = 90,0 °

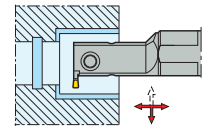

CTWS



- For inserts program, see page(s) 835-837, 853
- * DCINN – minimum bore diameter, see page(s) 705
- CTWS = Insert shape and size
- Right-hand version shown
- Please check availability at www.secotools.com / Seco Online Store

MDT



Mini-Shaft™

Designation	Item number	DMM	H	B	LF	LH	LU	WF	CDX**	DCINN*	Weight	CW	TQ	CTWS
		Inch	Inch	Inch	Inch	Inch	Inch	Inch	Inch	Inch	lbs	Inch	In/Lbs.	
A12-CGHL1902	02749019	0.750	0.671	0.711	8.000	1.535	1.181	0.551	0.197	0.790	0.880	0.079	44.3	LC..1902..
A12-CGHR1902	02749018	0.750	0.671	0.711	8.000	1.535	1.181	0.551	0.197	0.790	0.880	0.079	44.3	LC..1902..
A16-CGJL1902	02749021	1.000	0.921	0.961	10.000	1.732	1.575	0.748	0.276	0.985	1.760	0.079	44.3	LC..1902..
A16-CGJR1902	02749020	1.000	0.921	0.961	10.000	1.732	1.575	0.748	0.276	0.985	1.760	0.079	44.3	LC..1902..

Grooving

Spare Parts

Parting-off

For size	Clamp key	Clamp screw
A12..	 T15P-7	 L85011-T15P
A16..	T15P-7	L85011-T15P

X4

Adapters
Clamping units

Accessories and
Spare parts

Workpiece
materials

C.-CDIR/L – Toolholders for inserts LCGN, LCMF and LCMR – Metric/ Inch

C.-CDIR/L
KAPR

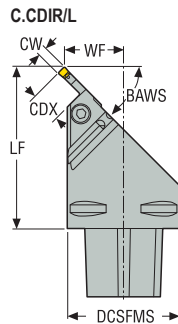
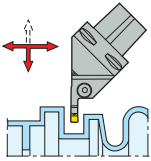

- For inserts program, see page(s) 839-852, 854-855
- CTMS = Seco-Capto™ size
- CTWS = Insert shape and size
- *** Max coolant pressure. When using toolholder together with an adapter the maximum coolant pressure might be limited, please see page(s) 85
- CDX = 3 x CW
- Left-hand version shown
- Please check availability at www.secotools.com / Seco Online Store

Designation	Item number	CTMS	DCSFMS		WF	LF	CDX**	BAWS°	Weight	CW	TQ	CTWS				
			mm	Inch									mm	Inch		
C6-CDIR-33090-03JET	02947205	C6	63,0	2.480	33,0	1.299	90	3.543	9,0	0.354	45,0	1,7	3,0	6,0	53.1	LC..1603..
C6-CDIL-33090-03JET	02612591	C6	63,0	2.480	33,0	1.299	90	3.543	9,0	0.354	45,0	1,7	3,0	6,0	53.1	LC..1603..
C6-CDIR-33090-04JET	02947206	C6	63,0	2.480	33,0	1.299	90	3.543	12,0	0.472	45,0	1,7	4,0	8,0	70.8	LC..1604..
C6-CDIL-33090-04JET	02612592	C6	63,0	2.480	33,0	1.299	90	3.543	12,0	0.472	45,0	1,7	4,0	8,0	70.8	LC..1604..
C6-CDIR-33090-05JET	02947207	C6	63,0	2.480	33,0	1.299	90	3.543	15,0	0.591	45,0	1,7	5,0	8,0	70.8	LC..1605..
C6-CDIL-33090-05JET	02612593	C6	63,0	2.480	33,0	1.299	90	3.543	15,0	0.591	45,0	1,7	5,0	8,0	70.8	LC..1605..
C6-CDIR-33090-06JET	02947208	C6	63,0	2.480	33,0	1.299	90	3.543	18,0	0.709	45,0	1,7	6,0	10,0	88.5	LC..1606..
C6-CDIL-33090-06JET	02612594	C6	63,0	2.480	33,0	1.299	90	3.543	18,0	0.709	45,0	1,7	6,0	10,0	88.5	LC..1606..
C6-CDIR-33090-08JET	02947209	C6	63,0	2.480	33,0	1.299	90	3.543	24,0	0.945	45,0	1,7	8,0	15,0	132.8	LC..3008..
C6-CDIL-33090-08JET	02612595	C6	63,0	2.480	33,0	1.299	90	3.543	24,0	0.945	45,0	1,7	8,0	15,0	132.8	LC..3008..

Spare Parts

For size	Clamp key	Clamp screw
CDIR/L..-03	4SMS795	TCEI0513
CDIR/L..-04	5SMS795	TCEI0613
CDIR/L..-05	5SMS795	TCEI0613
CDIR/L..-06	6SMS795	TCEI0815
CDIR/L..-08	6SMS795	TCEI1020

General ISO Turning

Steadyline®

MDT

Mini-Shaft™

Grooving

Parting-off

X4

Adapters
Clamping units

Accessories and
Spare parts

Workpiece
materials



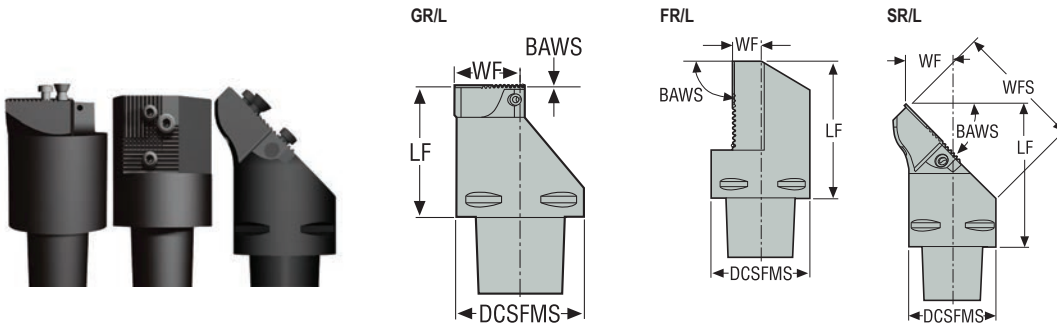

Toolholders – Metric/ Inch



- For blades program, see page(s) 826-829, 830
- How to assemble, see page(s) 702-704
- CTMS = Seco-Capto™ size
- Right-hand version shown
- Please check availability at www.secotools.com / Seco Online Store

Designation	Item number	CTMS	DCSFMS		WF		WFS	LF	BAWS°	Weight		TQ		
			mm	Inch	mm	Inch				mm	Inch	kg	lbs	Nm
C4-GR-21050-V21	00026919	C4	40,0	1.575	21,0	0.827	–	50	1.969	0,0	0,5	1.100	6,0	53.1
C4-GL-21050-V21	00026920	C4	40,0	1.575	21,0	0.827	–	50	1.969	0,0	0,5	1.100	6,0	53.1
C5-GR-29060-V21	00026921	C5	50,0	1.969	26,0	1.024	–	60	2.362	0,0	0,9	1.980	6,0	53.1
C5-GL-29060-V21	00026922	C5	50,0	1.969	26,0	1.024	–	60	2.362	0,0	0,9	1.980	6,0	53.1
C6-GR-39065-V21	00026923	C6	63,0	2.480	32,5	1.280	–	65	2.559	0,0	1,4	3.090	6,0	53.1
C6-GL-39065-V21	00026924	C6	63,0	2.480	32,5	1.280	–	65	2.559	0,0	1,4	3.090	6,0	53.1
C4-FR-11055-V21	00026912	C4	40,0	1.575	11,6	0.457	–	55	2.165	90,0	0,5	1.100	6,0	53.1
C4-FL-11055-V21	00026913	C4	40,0	1.575	11,6	0.457	–	55	2.165	90,0	0,5	1.100	6,0	53.1
C5-FR-16060-V21	00026914	C5	50,0	1.969	16,6	0.654	–	60	2.362	90,0	0,9	1.980	6,0	53.1
C5-FL-16060-V21	00026916	C5	50,0	1.969	16,6	0.654	–	60	2.362	90,0	0,9	1.980	6,0	53.1
C6-FR-23065-V21	00026917	C6	63,0	2.480	23,1	0.909	–	65	2.559	90,0	1,6	3.530	6,0	53.1
C6-FL-23065-V21	00026918	C6	63,0	2.480	23,1	0.909	–	65	2.559	90,0	1,6	3.530	6,0	53.1
C4-SR-21065-V21	02721138	C4	40,0	1.575	–	–	59,25	2.333	2.559	45,0	0,5	1.100	6,0	53.1
C4-SL-21065-V21	02721135	C4	40,0	1.575	–	–	59,25	2.333	2.559	45,0	0,5	1.100	6,0	53.1
C5-SR-26075-V21	02721139	C5	50,0	1.969	–	–	73,4	2.890	2.953	45,0	0,9	1.980	6,0	53.1
C5-SL-26075-V21	02721134	C5	50,0	1.969	–	–	73,4	2.890	2.953	45,0	0,9	1.980	6,0	53.1
C6-SR-33085-V21	02721140	C6	63,0	2.480	–	–	92,48	3.641	3.346	45,0	1,5	3.310	6,0	53.1
C6-SL-33085-V21	02721136	C6	63,0	2.480	–	–	92,48	3.641	3.346	45,0	1,5	3.310	6,0	53.1

Spare Parts

For size	Coolant nozzle	Key	Locking screw	Screw
..-V21	 CN6	 T20P-7L	 F85015-T20P	 C46017-T20P

- General ISO Turning
- Steadyline®
- MDT**
- Mini-Shaft™
- Grooving
- Parting-off
- X4
- Adapters
Clamping units
- Accessories and
Spare parts
- Workpiece
materials

General ISO Turning

Steadyline®

MDT

Mini-Shaft™

Grooving

Parting-off

X4

Adapters
Clamping units

Accessories and
Spare parts

Workpiece
materials

Toolholders – Metric

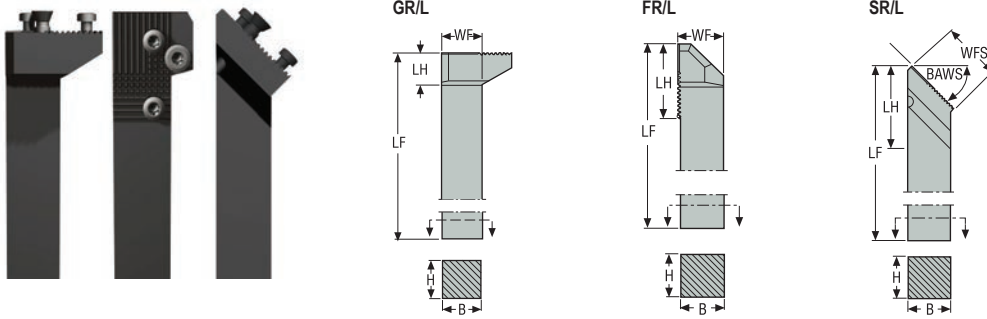

- For blades program, see page(s) 826-829, 830
- How to assemble, see page(s) 702-704
- Right-hand version shown
- Please check availability at www.secotools.com / Seco Online Store

Designation	Item number	H	B	LF	WF	WFS	LH	BAWS°	Weight	TQ
		mm	mm	mm	mm	mm	mm		kg	Nm
GR2020K-V21	00089073	20	20	125	19,9	–	16,0	0,0	0,5	6,0
GL2020K-V21	00089074	20	20	125	19,9	–	16,0	0,0	0,5	6,0
GR2525M-V21	00089075	25	25	150	24,9	–	16,0	0,0	0,8	6,0
GL2525M-V21	00089076	25	25	150	24,9	–	16,0	0,0	0,8	6,0
GR3225P-V21	00089077	32	25	170	24,9	–	16,0	0,0	1,2	6,0
GL3225P-V21	00089078	32	25	170	24,9	–	16,0	0,0	1,2	6,0
FR2020K-V21	00089081	20	20	125	20,8	–	33,64	90,0	0,5	6,0
FL2020K-V21	00089082	20	20	125	20,8	–	33,64	90,0	0,4	6,0
FR2525M-V21	00089083	25	25	150	25,8	–	33,64	90,0	0,8	6,0
FL2525M-V21	00089084	25	25	150	25,8	–	33,64	90,0	0,8	6,0
FR3225P-V21	00089085	32	25	170	25,8	–	33,64	90,0	1,1	6,0
FL3225P-V21	00089086	32	25	170	25,8	–	33,64	90,0	1,1	6,0
SR2020K-V21	02701074	20	20	125	–	34,64	43,5	45,0	0,4	6,0
SL2020K-V21	02701065	20	20	125	–	34,64	43,5	45,0	0,4	6,0
SR2525M-V21	02701075	25	25	150	–	34,64	47,5	45,0	0,8	6,0
SL2525M-V21	02701070	25	25	150	–	34,64	47,5	45,0	0,8	6,0
SR3225P-V21	02701076	32	25	170	–	34,64	47,5	45,0	1,1	6,0
SL3225P-V21	02701072	32	25	170	–	34,64	47,5	45,0	1,1	6,0

Spare Parts

For size	Key	Locking screw	Screw
...V21	T20P-7L	F85015-T20P	C46017-T20P

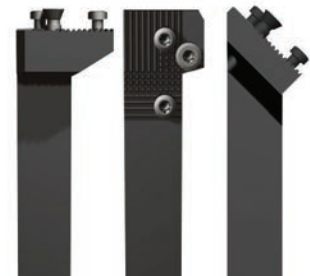
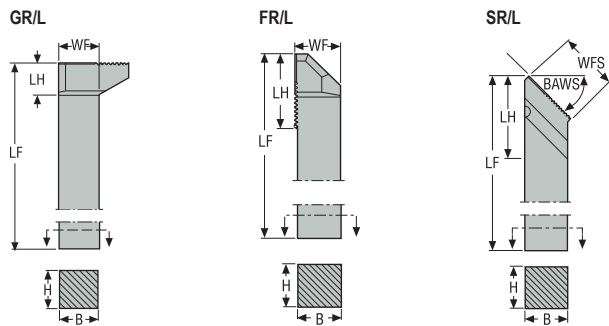

Toolholders – Inch



- For blades program, see page(s) 826-829, 830
- How to assemble, see page(s) 702-704
- Right-hand version shown
- Please check availability at www.secotools.com / Seco Online Store

Designation	Item number	H	B	LF	WF	WFS	LH	BAWS°	Weight	TQ
		Inch	Inch	Inch	Inch	Inch	Inch		lbs	In/Lbs.
GR075B-V21	00051869	0.750	0.750	4.500	0.750	–	0.630	0,0	0.880	53.1
GR100D-V21	00051907	1.000	1.000	6.000	1.000	–	0.630	0,0	1.980	53.1
GR125D-V21	00051927	1.250	1.250	6.000	1.250	–	0.630	0,0	2.650	53.1
GL075B-V21	00051879	0.750	0.750	4.500	0.750	–	0.630	0,0	0.880	53.1
GL100D-V21	00051909	1.000	1.000	6.000	1.000	–	0.630	0,0	1.980	53.1
GL125D-V21	00052403	1.250	1.250	6.000	1.250	–	0.630	0,0	2.650	53.1
FR100D-V21	00052447	1.000	1.000	6.000	1.035	–	1.330	90,0	1.540	53.1
FL100D-V21	00052454	1.000	1.000	6.000	1.035	–	1.330	90,0	1.540	53.1
SR075B-V21	02701110	0.750	0.750	4.500	–	1.648	1.648	45,0	0.880	53.1
SR100D-V21	02701111	1.000	1.000	6.000	–	2.002	2.002	45,0	1.760	53.1
SR125D-V21	02701112	1.250	1.250	6.000	–	2.355	2.355	45,0	2.650	53.1
SL075B-V21	02701081	0.750	0.750	4.500	–	1.648	1.648	45,0	0.880	53.1
SL100D-V21	02701107	1.000	1.000	6.000	–	2.002	2.002	45,0	1.760	53.1
SL125D-V21	02701108	1.250	1.250	6.000	–	2.355	2.355	45,0	2.650	53.1

Spare Parts

For size	Key	Locking screw	Screw
..-V21	 T20P-7L	 F85015-T20P	 C46017-T20P

General / ISO Turning

Steadyline®

MDT

Mini-Shaft™

Grooving

Parting-off

X4

Adapters
Clamping units

Accessories and
Spare parts

Workpiece
materials

General ISO Turning

Steadyline®

MDT

Mini-Shaft™

Grooving

Parting-off

X4

Adapters
Clamping units

Accessories and
Spare parts

Workpiece
materials



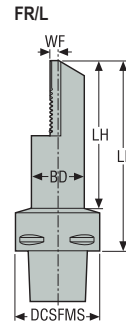

Toolholders – Metric/ Inch



- For blades program, see page(s) 826-829, 830
- How to assemble, see page(s) 702-704
- CTMS = Seco-Capto™ size
- Right-hand version shown
- Please check availability at www.secotools.com / Seco Online Store

Designation	Item number	CTMS	BD	DCSFMS	WF	LF	LH	Weight	TQ
			mm Inch	mm Inch	mm Inch	mm Inch	mm Inch	kg lbs	Nm In/Lbs.
C4-FR-04090-V21	00026925	C4	25,0 0.984	40,0 1.575	4,0 0.157	90 3.543	70,0 2.756	0,5 1.100	6,0 53.1
C4-FL-04090-V21	00026926	C4	25,0 0.984	40,0 1.575	4,0 0.157	90 3.543	70,0 2.756	0,5 1.100	6,0 53.1
C4-FR-07110-V21	00026927	C4	32,0 1.260	40,0 1.575	7,0 0.276	110 4.331	90,0 3.543	0,7 1.540	6,0 53.1
C4-FL-07110-V21	00026928	C4	32,0 1.260	40,0 1.575	7,0 0.276	110 4.331	90,0 3.543	0,7 1.540	6,0 53.1
C4-FR-11140-V21	00026929	C4	40,0 1.575	40,0 1.575	11,0 0.433	140 5.512	120,0 4.724	1,3 2.870	6,0 53.1
C4-FL-11140-V21	00026930	C4	40,0 1.575	40,0 1.575	11,0 0.433	140 5.512	120,0 4.724	1,3 2.870	6,0 53.1
C5-FR-04090-V21	00026931	C5	25,0 0.984	50,0 1.969	4,0 0.157	90 3.543	70,0 2.756	0,7 1.540	6,0 53.1
C5-FL-04090-V21	00026932	C5	25,0 0.984	50,0 1.969	4,0 0.157	90 3.543	70,0 2.756	0,7 1.540	6,0 53.1
C5-FR-07110-V21	00026933	C5	32,0 1.260	50,0 1.969	7,0 0.276	110 4.331	90,0 3.543	0,9 1.980	6,0 53.1
C5-FL-07110-V21	00026934	C5	32,0 1.260	50,0 1.969	7,0 0.276	110 4.331	90,0 3.543	0,9 1.980	6,0 53.1
C5-FR-11140-V21	00026935	C5	40,0 1.575	50,0 1.969	11,0 0.433	140 5.512	120,0 4.724	1,6 3.530	6,0 53.1
C5-FL-11140-V21	00026936	C5	40,0 1.575	50,0 1.969	11,0 0.433	140 5.512	120,0 4.724	1,6 3.530	6,0 53.1
C6-FR-04090-V21	00026937	C6	25,0 0.984	63,0 2.480	3,5 0.138	90 3.543	68,0 2.677	0,9 1.980	6,0 53.1
C6-FL-04090-V21	00026938	C6	25,0 0.984	63,0 2.480	3,5 0.138	90 3.543	68,0 2.677	0,9 1.980	6,0 53.1
C6-FR-07110-V21	00026939	C6	32,0 1.260	63,0 2.480	7,0 0.276	110 4.331	88,0 3.465	1,4 3.090	6,0 53.1
C6-FL-07110-V21	00026940	C6	32,0 1.260	63,0 2.480	7,0 0.276	110 4.331	88,0 3.465	1,4 3.090	6,0 53.1
C6-FR-11140-V21	00026941	C6	40,0 1.575	63,0 2.480	11,0 0.433	140 5.512	118,0 4.646	1,8 3.970	6,0 53.1
C6-FL-11140-V21	00026942	C6	40,0 1.575	63,0 2.480	11,0 0.433	140 5.512	118,0 4.646	1,8 3.970	6,0 53.1

Spare Parts

For size	Coolant nozzle	Key	Locking screw	Screw
..-V21	 CN6	 T20P-7L	 F85015-T20P	 C46017-T20P

- General ISO Turning
- Steadyline®
- MDT**
- Mini-Shaft™
- Grooving
- Parting-off
- X4
- Adapters
Clamping units
- Accessories and
Spare parts
- Workpiece
materials

General ISO Turning

Steadyline®

MDT

Mini-Shaft™

Grooving

Parting-off

X4

Adapters
Clamping units

Accessories and
Spare parts

Workpiece
materials

Toolholders – Metric

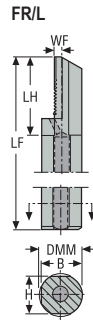

- For blades program, see page(s) 826-829, 830
- How to assemble, see page(s) 702-704
- Right-hand version shown
- Please check availability at www.secotools.com / Seco Online Store

Designation	Item number	DMM	H	B	LF	WF	LH	Weight	TQ
		mm	mm	mm	mm	mm	mm	kg	Nm
A25R-FR-V21	00089087	25	23	24,0	200	4,1	43,0	0,6	6,0
A25R-FL-V21	00089088	25	23	24,0	200	4,1	43,0	0,7	6,0
A32S-FR-V21	00089089	32	30	31,0	250	7,6	43,0	1,4	6,0
A32S-FL-V21	00089090	32	30	31,0	250	7,6	43,0	1,4	6,0
A40T-FR-V21	00089091	40	37	38,5	300	11,6	45,0	2,6	6,0
A40T-FL-V21	00089092	40	37	38,5	300	11,6	45,0	2,6	6,0

Spare Parts

For size	Key	Locking screw	Screw
A25R-	T20P-7L	F85015-T20P	C46017-T20P
A32S-	T20P-7L	F85015-T20P	C46017-T20P
A40T-	T20P-7L	F85015-T20P	C46017-T20P

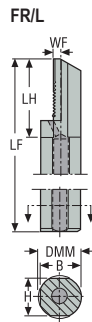

Toolholders – Inch



- For blades program, see page(s) 826-829, 830
- How to assemble, see page(s) 702-704
- Right-hand version shown
- Please check availability at www.secotools.com / Seco Online Store

Designation	Item number	DMM	H	B	LF	WF	LH	Weight	TQ
		Inch	Inch	Inch	Inch	Inch	Inch	lbs	In/Lbs.
A16-FR-V21	00055205	1.000	0.921	0.961	8.000	0.169	1.693	1.540	53.1
A16-FL-V21	00055241	1.000	0.921	0.961	8.000	0.169	1.693	1.540	53.1
A20-FR-V21	00055242	1.250	1.171	1.211	10.000	0.294	1.693	3.090	53.1
A20-FL-V21	00055275	1.250	1.171	1.211	10.000	0.294	1.693	3.090	53.1
A24-FR-V21	00055356	1.500	1.339	1.441	12.000	0.420	1.693	5.290	53.1
A24-FL-V21	00055404	1.500	1.339	1.441	12.000	0.420	1.693	5.290	53.1

Spare Parts

For size	Key	Locking screw	Screw
..-V21	 T20P-7L	 F85015-T20P	 C46017-T20P

General ISO Turning

Steadyline®

MDT

Mini-Shaft™

Grooving

Parting-off

X4

Adapters
Clamping units

Accessories and
Spare parts

Workpiece
materials

General ISO Turning

Steadyline®

MDT

Mini-Shaft™

Grooving

Parting-off

X4

Adapters
Clamping units

Accessories and
Spare parts

Workpiece
materials

V21-C.R/LBlades for inserts LCGF, LCGN, LCMF and LCMR – Metric



CTWS

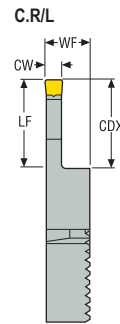

C.R/L
KAPR = 90,0 °

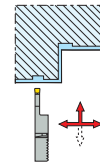

- For holders program, see page(s) 818, 819-825
- For inserts program, see page(s) 835-837, 839-855
- ** Max depth of cut for LCGF/LCMF13.. = 11 mm, LCGF/LCMF16.. = 14 mm
- Right-hand version shown
- Please check availability at www.secotools.com / Seco Online Store

Designation	Item number	LF	WF	CDX**	Weight	CW	TQ	CTWS
		mm	mm	mm	kg	mm	Nm	
V21-CIR1303	02717485	10	9,2	9,0	0,1	3,0	6,0	LC..1303..
V21-CIL1303	02718916	10	9,2	9,0	0,1	3,0	6,0	LC..1303..
V21-CMR1303	02718924	16	9,2	15,0	0,1	3,0	6,0	LC..1303..
V21-CML1303	02719033	16	9,2	15,0	0,1	3,0	6,0	LC..1303..
V21-CMR1603	00030310	16	9,2	15,0	0,1	3,0	6,0	LC..1603..
V21-CML1603	02719038	16	9,2	15,0	0,1	3,0	6,0	LC..1603..
V21-CIR1304	02563710	13	9,2	12,0	0,1	4,0	6,0	LC..1304..
V21-CIL1304	02718919	13	9,2	12,0	0,1	4,0	6,0	LC..1304..
V21-CMR1304	02719034	21	9,2	20,0	0,1	4,0	6,0	LC..1304..
V21-CML1304	02719035	21	9,2	20,0	0,1	4,0	6,0	LC..1304..
V21-CMR1604	02719039	21	9,2	20,0	0,1	4,0	6,0	LC..1604..
V21-CML1604	02719040	21	9,2	20,0	0,1	4,0	6,0	LC..1604..
V21-CIR1605	02718920	16	9,2	15,0	0,1	5,0	6,0	LC..1605..
V21-CIL1605	02718921	16	9,2	15,0	0,1	5,0	6,0	LC..1605..
V21-CMR1605	02719041	26	9,2	25,0	0,1	5,0	6,0	LC..1605..
V21-CML1605	02719042	26	9,2	25,0	0,1	5,0	6,0	LC..1605..
V21-CIR1606	02718922	19	9,2	18,0	0,1	6,0	6,0	LC..1606..
V21-CIL1606	02718923	19	9,2	18,0	0,1	6,0	6,0	LC..1606..
V21-CMR1606	02719043	31	9,2	30,0	0,1	6,0	6,0	LC..1606..
V21-CML1606	02719044	31	9,2	30,0	0,1	6,0	6,0	LC..1606..

V21-C.R/LBlades for inserts LCGF, LCGN, LCMF and LCMR – Metric

C.R/L
KAPR = 90,0°

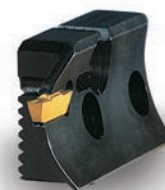
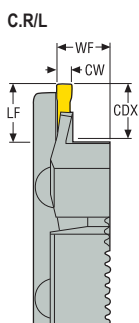
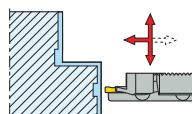

CTWS



- For holders program, see page(s) 818, 819-825
- For inserts program, see page(s) 835-837, 853
- Initial plunge (INPLM/INPLX) relates to face groove diameter, see page(s) 705
- ** Max depth of cut for LCGF/LCMF13.. = 11 mm
- Right-hand version with left-hand blade shown
- Please check availability at www.secotools.com / Seco Online Store

Designation	Item number	INPLM	INPLX	LF	WF	CDX**	Weight	CW	TQ	CTWS
		mm	mm	mm	mm	mm	kg	mm	Nm	
V21-CJR1303L030017	00089095	17	30	12	9,2	10,5	0,1	3,0	6,0	LC..1303..
V21-CJR1303L039024	00089099	24	39	12	9,2	10,5	0,1	3,0	6,0	LC..1303..
V21-CKR1303L050033	00089103	33	50	13	9,2	12,0	0,1	3,0	6,0	LC..1303..
V21-CKR1303L060043	00089107	43	60	13	9,2	12,0	0,1	3,0	6,0	LC..1303..
V21-CKR1303L076053	00089111	53	76	13	9,2	12,0	0,1	3,0	6,0	LC..1303..
V21-COR1303L030017	02718887	17	30	19	9,2	18,0	0,1	3,0	6,0	LC..1303..
V21-COR1303L039024	02718888	24	39	19	9,2	18,0	0,1	3,0	6,0	LC..1303..
V21-COR1303L050033	02718889	33	50	19	9,2	18,0	0,1	3,0	6,0	LC..1303..
V21-COR1303L060043	02718890	43	60	19	9,2	18,0	0,1	3,0	6,0	LC..1303..
V21-COR1303L076053	02718891	53	76	19	9,2	18,0	0,1	3,0	6,0	LC..1303..
V21-COR1303L100070	02718910	70	100	19	9,2	18,0	0,1	3,0	6,0	LC..1303..
V21-COR1303L136094	02718911	94	136	19	9,2	18,0	0,1	3,0	6,0	LC..1303..
V21-COR1303L200130	02718912	130	200	19	9,2	18,0	0,1	3,0	6,0	LC..1303..
V21-CJL1303R030017	00089094	17	30	12	9,2	10,5	0,1	3,0	6,0	LC..1303..
V21-CJL1303R039024	00089098	24	39	12	9,2	10,5	0,1	3,0	6,0	LC..1303..
V21-CKL1303R050033	00089102	33	50	13	9,2	12,0	0,1	3,0	6,0	LC..1303..
V21-CKL1303R060043	00089106	43	60	13	9,2	12,0	0,1	3,0	6,0	LC..1303..
V21-CKL1303R076053	00089110	53	76	13	9,2	12,0	0,1	3,0	6,0	LC..1303..
V21-COL1303R030017	02718882	17	30	19	9,2	18,0	0,1	3,0	6,0	LC..1303..
V21-COL1303R039024	02718883	24	39	19	9,2	18,0	0,1	3,0	6,0	LC..1303..
V21-COL1303R050033	02718884	33	50	19	9,2	18,0	0,1	3,0	6,0	LC..1303..
V21-COL1303R060043	02718885	43	60	19	9,2	18,0	0,1	3,0	6,0	LC..1303..
V21-COL1303R076053	02718886	53	76	19	9,2	18,0	0,1	3,0	6,0	LC..1303..
V21-COL1303R100070	02718907	70	100	19	9,2	18,0	0,1	3,0	6,0	LC..1303..
V21-COL1303R136094	02718908	94	136	19	9,2	18,0	0,1	3,0	6,0	LC..1303..
V21-COL1303R200130	02718909	130	200	19	9,2	18,0	0,1	3,0	6,0	LC..1303..
V21-CHR1304L030017	00089115	17	30	11	9,2	10,0	0,1	4,0	6,0	LC..1304..
V21-CHR1304L034021	00089119	21	34	11	9,2	10,0	0,1	4,0	6,0	LC..1304..
V21-CIR1304L040026	00089123	26	40	13	9,2	12,0	0,1	4,0	6,0	LC..1304..
V21-CIR1304L050032	00089127	32	50	13	9,2	12,0	0,1	4,0	6,0	LC..1304..
V21-CIR1304L060042	00089131	42	60	13	9,2	12,0	0,1	4,0	6,0	LC..1304..
V21-CIR1304L075052	00089135	52	75	13	9,2	12,0	0,1	4,0	6,0	LC..1304..

General ISO Turning

Steadyline®

MDT

Mini-Shaft™

Grooving

Parting-off

X4

Adapters
Clamping units

Accessories and
Spare parts

Workpiece
materials

	Designation	Item number	INPLM	INPLX	LF	WF	CDX**	Weight	CW	TQ	CTWS
			mm	mm	mm	mm	mm	kg	mm	Nm	
General ISO Turning	V21-CIR1304L100067	00089139	67	100	13	9,2	12,0	0,1	4,0	6,0	LC..1304..
	V21-CMR1304L030017	02718867	17	30	21	9,2	20,0	0,1	4,0	6,0	LC..1304..
	V21-CMR1304L034021	02718868	21	34	21	9,2	20,0	0,1	4,0	6,0	LC..1304..
	V21-CMR1304L040026	02611685	26	40	21	9,2	20,0	0,1	4,0	6,0	LC..1304..
	V21-CMR1304L050032	02718869	32	50	21	9,2	20,0	0,1	4,0	6,0	LC..1304..
Steadyline®	V21-CMR1304L060042	02487944	42	60	21	9,2	20,0	0,1	4,0	6,0	LC..1304..
	V21-CMR1304L075052	02718870	52	75	21	9,2	20,0	0,1	4,0	6,0	LC..1304..
	V21-CMR1304L100067	02718871	67	100	21	9,2	20,0	0,1	4,0	6,0	LC..1304..
	V21-CMR1304L135092	02718900	92	135	21	9,2	20,0	0,1	4,0	6,0	LC..1304..
	V21-CMR1304L200127	02718901	127	200	21	9,2	20,0	0,1	4,0	6,0	LC..1304..
MDT	V21-CHL1304R030017	00089114	17	30	11	9,2	10,0	0,1	4,0	6,0	LC..1304..
	V21-CHL1304R034021	00089118	21	34	11	9,2	10,0	0,1	4,0	6,0	LC..1304..
	V21-CIL1304R040026	00089122	26	40	13	9,2	12,0	0,1	4,0	6,0	LC..1304..
	V21-CIL1304R050032	00089126	32	50	13	9,2	12,0	0,1	4,0	6,0	LC..1304..
	V21-CIL1304R060042	00089130	42	60	13	9,2	12,0	0,1	4,0	6,0	LC..1304..
Mini-Shaft™	V21-CIL1304R075052	00089134	52	75	13	9,2	12,0	0,1	4,0	6,0	LC..1304..
	V21-CIL1304R100067	00089138	67	100	13	9,2	12,0	0,1	4,0	6,0	LC..1304..
	V21-CML1304R030017	00030305	17	30	21	9,2	20,0	0,1	4,0	6,0	LC..1304..
	V21-CML1304R034021	02531134	21	34	21	9,2	20,0	0,1	4,0	6,0	LC..1304..
	V21-CML1304R040026	02718861	26	40	21	9,2	20,0	0,1	4,0	6,0	LC..1304..
Grooving	V21-CML1304R050032	02718862	32	50	21	9,2	20,0	0,1	4,0	6,0	LC..1304..
	V21-CML1304R060042	02718864	42	60	21	9,2	20,0	0,1	4,0	6,0	LC..1304..
	V21-CML1304R075052	02718865	52	75	21	9,2	20,0	0,1	4,0	6,0	LC..1304..
	V21-CML1304R100067	02718866	67	100	21	9,2	20,0	0,1	4,0	6,0	LC..1304..
	V21-CML1304R135092	02718898	92	135	21	9,2	20,0	0,1	4,0	6,0	LC..1304..
	V21-CML1304R200127	02718899	127	200	21	9,2	20,0	0,1	4,0	6,0	LC..1304..
Parting-off											
X4											
Adapters Clamping units											
Accessories and Spare parts											
Workpiece materials											

V21-C.R/L Blades for inserts LCGF, LCGN, LCMF and LCMR – Metric

C.R/L
KAPR = 90,0°

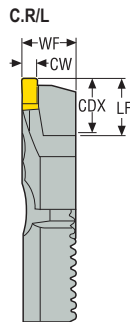
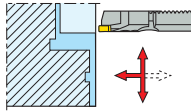

CTWS



- For holders program, see page(s) 818, 819-825
- For inserts program, see page(s) 835-837, 853
- Initial plunge (INPLM/INPLX) relates to face groove diameter, see page(s) 705
- ** Max depth of cut for LCGF/LCMF13.. = 11 mm
- Right-hand version with right-hand blade shown
- Please check availability at www.secotools.com / Seco Online Store

Designation	Item number	INPLM	INPLX	LF	WF	CDX**	Weight	CW	TQ	CTWS
		mm	mm	mm	mm	mm	kg	mm	Nm	
V21-CJR1303R030017	00089093	17	30	12	9,2	10,5	0,1	3,0	6,0	LC..1303..
V21-CJR1303R039024	00089097	24	39	12	9,2	10,5	0,1	3,0	6,0	LC..1303..
V21-CKR1303R050033	00089101	33	50	13	9,2	12,0	0,1	3,0	6,0	LC..1303..
V21-CKR1303R060043	00089105	43	60	13	9,2	12,0	0,1	3,0	6,0	LC..1303..
V21-CKR1303R076053	00089109	53	76	13	9,2	12,0	0,1	3,0	6,0	LC..1303..
V21-COR1303R030017	02469196	17	30	19	9,2	18,0	0,1	3,0	6,0	LC..1303..
V21-COR1303R039024	02718892	24	39	19	9,2	18,0	0,1	3,0	6,0	LC..1303..
V21-COR1303R050033	02718893	33	50	19	9,2	18,0	0,1	3,0	6,0	LC..1303..
V21-COR1303R060043	02718894	43	60	19	9,2	18,0	0,1	3,0	6,0	LC..1303..
V21-COR1303R076053	02718895	53	76	19	9,2	18,0	0,1	3,0	6,0	LC..1303..
V21-COR1303R100070	02718913	70	100	19	9,2	18,0	0,1	3,0	6,0	LC..1303..
V21-COR1303R136094	02718914	94	136	19	9,2	18,0	0,1	3,0	6,0	LC..1303..
V21-COR1303R200130	02718915	130	200	19	9,2	18,0	0,1	3,0	6,0	LC..1303..
V21-CJL1303L030017	00089096	17	30	12	9,2	10,5	0,1	3,0	6,0	LC..1303..
V21-CJL1303L039024	00089100	24	39	12	9,2	10,5	0,1	3,0	6,0	LC..1303..
V21-CKL1303L050033	00089104	33	50	13	9,2	12,0	0,1	3,0	6,0	LC..1303..
V21-CKL1303L060043	00089108	43	60	13	9,2	12,0	0,1	3,0	6,0	LC..1303..
V21-CKL1303L076053	00089112	53	76	13	9,2	12,0	0,1	3,0	6,0	LC..1303..
V21-COL1303L030017	02718878	17	30	19	9,2	18,0	0,1	3,0	6,0	LC..1303..
V21-COL1303L039024	02718879	24	39	19	9,2	18,0	0,1	3,0	6,0	LC..1303..
V21-COL1303L050033	02579940	33	50	19	9,2	18,0	0,1	3,0	6,0	LC..1303..
V21-COL1303L060043	02718880	43	60	19	9,2	18,0	0,1	3,0	6,0	LC..1303..
V21-COL1303L076053	02718881	53	76	19	9,2	18,0	0,1	3,0	6,0	LC..1303..
V21-COL1303L100070	02718904	70	100	19	9,2	18,0	0,1	3,0	6,0	LC..1303..
V21-COL1303L136094	02718905	94	136	19	9,2	18,0	0,1	3,0	6,0	LC..1303..
V21-COL1303L200130	02718906	130	200	19	9,2	18,0	0,1	3,0	6,0	LC..1303..
V21-CHR1304R030017	00089113	17	30	11	9,2	10,0	0,1	4,0	6,0	LC..1304..
V21-CHR1304R034021	00089117	21	34	11	9,2	10,0	0,1	4,0	6,0	LC..1304..
V21-CIR1304R040026	00089121	26	40	13	9,2	12,0	0,1	4,0	6,0	LC..1304..
V21-CIR1304R050032	00089125	32	50	13	9,2	12,0	0,1	4,0	6,0	LC..1304..
V21-CIR1304R060042	00089129	42	60	13	9,2	12,0	0,1	4,0	6,0	LC..1304..
V21-CIR1304R075052	00089133	52	75	13	9,2	12,0	0,1	4,0	6,0	LC..1304..

General ISO Turning

Steadyline®

MDT

Mini-Shaft™

Grooving

Parting-off

X4

Adapters
Clamping units

Accessories and
Spare parts

Workpiece
materials

	Designation	Item number	INPLM	INPLX	LF	WF	CDX**	Weight	CW	TQ	CTWS
			mm	mm	mm	mm	mm	kg	mm	Nm	
General ISO Turning	V21-CIR1304R100067	00089137	67	100	13	9,2	12,0	0,1	4,0	6,0	LC..1304..
	V21-CMR1304R030017	02718872	17	30	21	9,2	20,0	0,1	4,0	6,0	LC..1304..
	V21-CMR1304R034021	02718873	21	34	21	9,2	20,0	0,1	4,0	6,0	LC..1304..
	V21-CMR1304R040026	02450834	26	40	21	9,2	20,0	0,1	4,0	6,0	LC..1304..
	V21-CMR1304R050032	02718874	32	50	21	9,2	20,0	0,1	4,0	6,0	LC..1304..
Steadyline®	V21-CMR1304R060042	02718875	42	60	21	9,2	20,0	0,1	4,0	6,0	LC..1304..
	V21-CMR1304R075052	02718876	52	75	21	9,2	20,0	0,1	4,0	6,0	LC..1304..
	V21-CMR1304R100067	02718877	67	100	21	9,2	20,0	0,1	4,0	6,0	LC..1304..
	V21-CMR1304R135092	02718902	92	135	21	9,2	20,0	0,1	4,0	6,0	LC..1304..
	V21-CMR1304R200127	02718903	127	200	21	9,2	20,0	0,1	4,0	6,0	LC..1304..
MDT	V21-CHL1304L030017	00089116	17	30	11	9,2	10,0	0,1	4,0	6,0	LC..1304..
	V21-CHL1304L034021	00089120	21	34	11	9,2	10,0	0,1	4,0	6,0	LC..1304..
	V21-CIL1304L040026	00089124	26	40	13	9,2	12,0	0,1	4,0	6,0	LC..1304..
	V21-CIL1304L050032	00089128	32	50	13	9,2	12,0	0,1	4,0	6,0	LC..1304..
	V21-CIL1304L060042	00089132	42	60	13	9,2	12,0	0,1	4,0	6,0	LC..1304..
Mini-Shaft™	V21-CIL1304L075052	00089136	52	75	13	9,2	12,0	0,1	4,0	6,0	LC..1304..
	V21-CIL1304L100067	00089140	67	100	13	9,2	12,0	0,1	4,0	6,0	LC..1304..
	V21-CML1304L030017	02452926	17	30	21	9,2	20,0	0,1	4,0	6,0	LC..1304..
	V21-CML1304L034021	02717475	21	34	21	9,2	20,0	0,1	4,0	6,0	LC..1304..
	V21-CML1304L040026	02611687	26	40	21	9,2	20,0	0,1	4,0	6,0	LC..1304..
Grooving	V21-CML1304L050032	02718854	32	50	21	9,2	20,0	0,1	4,0	6,0	LC..1304..
	V21-CML1304L060042	02576753	42	60	21	9,2	20,0	0,1	4,0	6,0	LC..1304..
	V21-CML1304L075052	02718855	52	75	21	9,2	20,0	0,1	4,0	6,0	LC..1304..
	V21-CML1304L100067	02718856	67	100	21	9,2	20,0	0,1	4,0	6,0	LC..1304..
	V21-CML1304L135092	02718896	92	135	21	9,2	20,0	0,1	4,0	6,0	LC..1304..
Parting-off	V21-CML1304L200127	02718897	127	200	21	9,2	20,0	0,1	4,0	6,0	LC..1304..
X4											
Adapters Clamping units											
Accessories and Spare parts											
Workpiece materials											

CF..ITX-..LRBJET – Toolholders for inserts LCGF, LCGN, LCMF and LCMR – Metric

CF..ITX-..LRBJET
KAPR = 90,0°

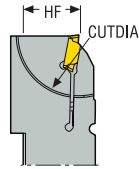
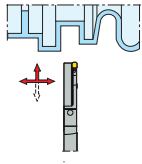

CF..ITX-..LRBJET

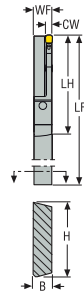

CTWS



- For inserts program, see page(s) 838-852, 854-855
- For more information on Jetstream Tooling® (High pressure coolant) and accessories, please see page(s) 38, 85-89, 1002
- * Due to the design, grooving depth is limited, see page(s) 705, max depth of cut for LCGF/LCMF16.. = 14 mm
- *** Max coolant pressure using hose connection
- Left-hand version shown
- Please check availability at www.secotools.com / Seco Online Store

Designation	Item number	H	B	LF	WF	LH	HF	CUTDIA*	CP***	Weight	CW	TQ	CTWS
		mm	mm	mm	mm	mm	mm	mm	bar	kg	mm	Nm	
CFXL26ITX-1603LRBJET	02833866	26	8	117,5	8	50,5	21,4	65,0	275,0	0,2	3,0	6,0	LC..1603..
CFXL32ITX-1603LRBJET	02833867	32	8	117,5	8	50,5	24,8	65,0	275,0	0,2	3,0	6,0	LC..1603..
CFTL26ITX-1902LRBJET	02833868	26	8	110,0	8	43,0	21,4	36,0	275,0	0,2	2,0	6,0	LC..1902..
CFZL32ITX-2802LRBJET	02833865	32	8	110,0	8	47,0	24,8	54,0	275,0	0,2	2,0	6,0	LC..2802..

Spare Parts

For size	Clamp key	Clamp screw
26-32	3SMS795	MC6S4X18

General ISO Turning

Steadyline®

MDT

Mini-Shaft™

Grooving

Parting-off

X4

Adapters
Clamping units

Accessories and
Spare parts

Workpiece
materials

CF..ITX..RBToolholders for inserts LCGF, LCGN, LCMF and LCMR – Metric



CTWS

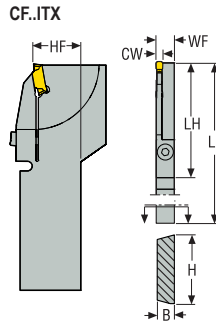

CF..ITX
KAPR = 90,0 °

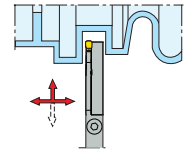

- Blades up to D = 65
- For inserts program, see page(s) 838-852, 854-855
- * Due to the design, grooving depth is limited, see page(s) 705, max depth of cut for LCGF/LCMF16.. = 14 mm
- Right-hand version shown
- Please check availability at www.secotools.com / Seco Online Store

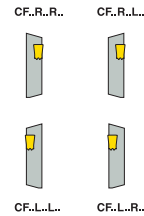

Designation	Item number	H	B	LF	WF	LH	HF	CUTDIA*	Weight	CW	TQ	CTWS
		mm	mm	mm	mm	mm	mm	mm	kg	mm	Nm	
CFTR26ITX1902RRB	02830353	26	7,85	110,0	8	44,0	20,9	34,0	0,2	2,0	6,0	LCMF1902..
CFTR32ITX1902RRB	02830365	32	7,85	110,0	8	43,0	24,5	34,0	0,2	2,0	6,0	LCMF1902..
CFTR26ITX1902LRB	02830354	26	7,85	110,0	8	44,0	20,9	34,0	0,2	2,0	6,0	LCMF1902..
CFTR32ITX1902LRB	02830366	32	7,85	110,0	8	43,0	24,5	34,0	0,2	2,0	6,0	LCMF1902..
CFTL26ITX1902RRB	02830351	26	7,85	110,0	8	44,0	20,9	34,0	0,2	2,0	6,0	LCMF1902..
CFTL32ITX1902RRB	02830363	32	7,85	110,0	8	43,0	24,5	34,0	0,2	2,0	6,0	LCMF1902..
CFTL26ITX1902LRB	02830352	26	7,85	110,0	8	44,0	20,9	34,0	0,2	2,0	6,0	LCMF1902..
CFTL32ITX1902LRB	02830364	32	7,85	110,0	8	43,0	24,5	34,0	0,2	2,0	6,0	LCMF1902..
CFZR26ITX2802RRB	02830357	26	7,85	119,1	8	51,5	20,9	54,0	0,2	2,0	6,0	LCMF2802..
CFZR32ITX2802RRB	02830369	32	7,85	119,1	8	52,0	32,0	54,0	0,2	2,0	6,0	LCMF2802..
CFZR26ITX2802LRB	02830358	26	7,85	119,1	8	51,5	20,9	54,0	0,2	2,0	6,0	LCMF2802..
CFZR32ITX2802LRB	02830370	32	7,85	119,1	8	52,5	32,0	54,0	0,2	2,0	6,0	LCMF2802..
CFZL32ITX2802RRB	02830367	32	7,85	119,5	8	52,0	24,5	54,0	0,2	2,0	6,0	LCMF2802..
CFZL26ITX2802RRB	02830355	26	7,85	119,1	8	51,5	20,9	54,0	0,2	2,0	6,0	LCMF2802..
CFZL26ITX2802LRB	02830356	26	7,85	119,1	8	51,5	20,9	54,0	0,2	2,0	6,0	LCMF2802..
CFZL32ITX2802LRB	02830368	32	7,85	119,1	8	52,0	24,5	54,0	0,3	2,0	6,0	LCMF2802..
CFXR32ITX1603RRB	02834803	32	7,85	117,5	8	50,5	24,5	65,0	0,3	3,0	6,0	LC..1603..
CFXR32ITX1603LRB	02834804	32	7,85	117,5	8	50,5	24,5	65,0	0,3	3,0	6,0	LC..1603..
CFXL32ITX1603RRB	02834801	32	7,85	117,5	8	50,5	24,5	65,0	0,3	3,0	6,0	LC..1603..
CFXL32ITX1603LRB	02834802	32	7,85	117,5	8	50,5	24,5	65,0	0,3	3,0	6,0	LC..1603..

Spare Parts

For size	Clamp key	Clamp screw
26-32	3SMS795	TCEI0416

SFN and CF.N – Toolholder and blades for inserts LCGN, LCMF and LCMR – Metric

SFN/CF.N
KAPR = 90,0°

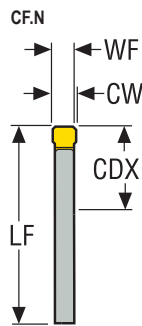
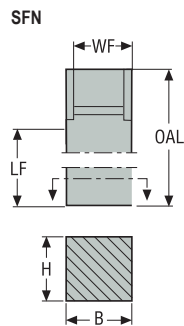
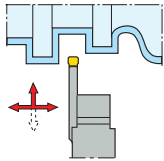

- For inserts program, see page(s) 839-852, 854-855
- ** Max depth of cut for LCGF/LCMF16.. = 14 mm
- Please check availability at www.secotools.com / Seco Online Store

Designation	Item number	H	B	LF	OAL	WF	CDX	Weight	CW	TQ	CTWS
		mm	mm	mm	mm	mm	mm	kg	mm	Nm	
SFN2525N	00023587	25	25	101,2	134	21,7	-	0,7	-	6,0	Blade-GAD
CFLN-03	00036564	-	-	46,4	-	2,6	13,0	0,1	3,0	6,0	LC..1603..
CFKN-04	00027198	-	-	48,6	-	3,6	15,0	0,1	4,0	6,0	LC..1604..
CFNN-04	00027200	-	-	55,0	-	3,6	22,0	0,1	4,0	6,0	LC..1604..
CFIN-05	00027201	-	-	48,6	-	4,6	15,0	0,1	5,0	6,0	LC..1605..
CFHN-06	00027203	-	-	48,6	-	5,6	15,0	0,1	6,0	6,0	LC..1606..
CFJN-06	00027204	-	-	55,0	-	5,6	22,0	0,1	6,0	6,0	LC..1606..

Spare Parts

For size	Key	Locking screw	Screw
SFN2525N	T20P-7	C46017-T20P	C45013-T20P

General ISO Turning

Steadyline®

MDT

Mini-Shaft™

Grooving

Parting-off

X4

Adapters
Clamping units

Accessories and
Spare parts

Workpiece
materials

General ISO Turning

CF.N – Blades for inserts LCGN, LCMF and LCMR – Metric

Steadyline®

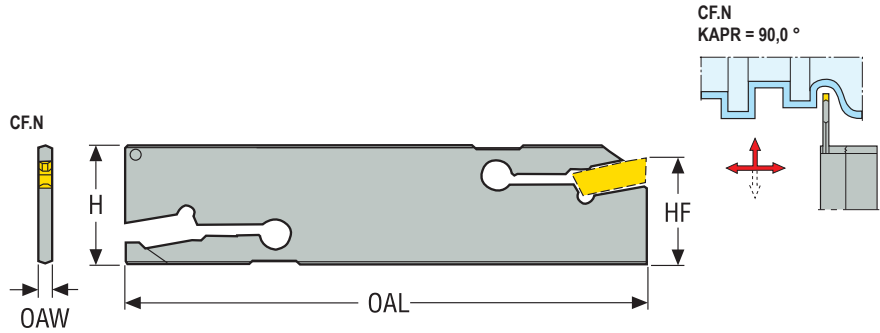

CTWS



MDT

- For inserts program, see page(s) 839-852, 854-855
- * CUTDIA for LCMF16.. = 28 mm
- Please check availability at www.secotools.com / Seco Online Store

Mini-Shaft™

Designation	Item number	OAW	OAL	HF	H	CUTDIA*	Weight	CW	TQ	CTWS
		mm	mm	mm	mm	mm	kg	mm	Nm	
CFMN26-03	00053878	2,4	110	21,4	26	25,0	0,1	3,0		LC..1603..
CFON32-03	00053889	2,4	150	24,8	32	34,0	0,1	3,0		LC..1603..
CFMN32-04	00053883	3,0	150	24,8	32	34,0	0,1	4,0		LC..1604..
CFMN32-05	00053884	4,0	150	24,8	32	48,0	0,2	5,0		LC..1605..
CFKN32-06	00053885	5,0	150	24,8	32	48,0	0,2	6,0		LC..1606..

Grooving

Parting-off



To be used in standard 150.10 holder

CF..26... to be used in 150.10-....-20JETI
CF..32... to be used in 150.10-....-25JETI

X4

Adapters
Clamping units

Accessories and
Spare parts

Workpiece
materials

Please check availability at www.secotools.com / Seco Online Store

Tolerances:
CW = ±0,05/0,002
IGL = ±0,08/0,003
S = ±0,05/0,002

IGL = Distance cutting edge-rear support

LCMF, LCMR

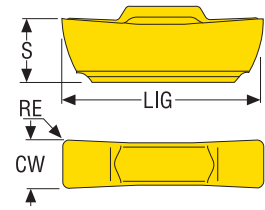

LCMF-FT



LCMR-FT

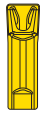

LCMF-MC



Designation	RE	CW	LIG	S	Grades								
					Coated						Uncoated		
					CP200	CP500	CP600	TGH1050	TGK1500	TGP25	TGS2050	883	890
mm Inch	mm Inch	mm Inch	mm Inch										
LCMF130302-0300-FT	0,2 0.008	3,0 0.118	12,4 0.488	4,0 0.157		■							
LCMF130304-0300-FT	0,4 0.016	3,0 0.118	12,4 0.488	4,0 0.157		■			■	■			
LCMF130402-0400-FT	0,2 0.008	4,0 0.157	12,4 0.488	4,0 0.157		■							
LCMF130404-0400-FT	0,4 0.016	4,0 0.157	12,4 0.488	4,0 0.157		■			■	■			
LCMR130302-0300-FT	0,2 0.008	3,0 0.118	12,4 0.488	4,0 0.157		■							
LCMR130304-0300-FT	0,4 0.016	3,0 0.118	12,4 0.488	4,0 0.157		■							
LCMR130404-0400-FT	0,4 0.016	4,0 0.157	12,4 0.488	4,0 0.157		■							
LCMF130304-0300-MC	0,4 0.016	3,0 0.118	12,4 0.488	4,0 0.157		■				■			
LCMF130404-0400-MC	0,4 0.016	4,0 0.157	12,4 0.488	4,0 0.157		■				■			

General ISO Turning

Steadyline®

MDT

Mini-Shaft™

Grooving

Parting-off

X4

Adapters
Clamping units

Accessories and
Spare parts

Workpiece
materials

General ISO Turning

LCGF

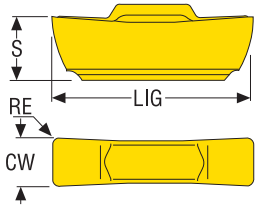

Tolerances:
CW = $\pm 0,025/0,001$
LIG = $\pm 0,025/0,001$
S = $\pm 0,05/0,002$

Please check availability at www.secotools.com / Seco Online Store

LIG = Distance cutting edge-rear support

Steadyline®

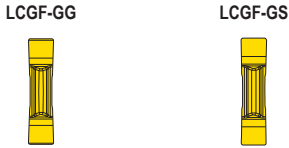

MDT

Designation	RE	CW	LIG	S	Grades								
					Coated								Uncoated
	mm Inch	mm Inch	mm Inch	mm Inch	CP200	CP500	CP600	TGH1050	TGK1500	TGP25	TGS2050	883	890
LCGF130302-0300-GG	0,2 0.008	3,0 0.118	12,4 0.488	3,9 0.154		■							
LCGF130402-0400-GG	0,2 0.008	4,0 0.157	12,4 0.488	3,9 0.154		■							
LCGF130302-0300-GS	0,2 0.008	3,0 0.118	12,4 0.488	3,9 0.154								■	
LCGF130402-0400-GS	0,2 0.008	4,0 0.157	12,4 0.488	3,9 0.154								■	

Mini-Shaft™

Grooving

LCMF, LCMR

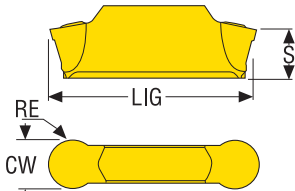

Tolerances:
CW = $\pm 0,05/0,002$
LIG = $\pm 0,08/0,003$
S = $\pm 0,05/0,002$

Please check availability at www.secotools.com / Seco Online Store

LIG = Distance cutting edge-rear support

Parting-off

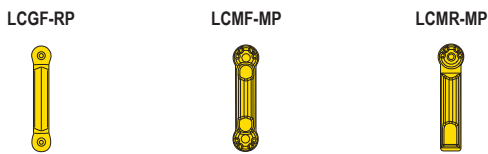

X4

Designation	RE	CW	LIG	S	Grades								
					Coated								Uncoated
	mm Inch	mm Inch	mm Inch	mm Inch	CP200	CP500	CP600	TGH1050	TGK1500	TGP25	TGS2050	883	890
LCGF1303M0-0300-RP	1,5 0.059	3,0 0.118	12,4 0.488	4,0 0.157		■					■		
LCMF1303M0-0300-MP	1,5 0.059	3,0 0.118	12,4 0.488	4,0 0.157		■			■	■			
LCMF1304M0-0400-MP	2,0 0.079	4,0 0.157	12,4 0.488	4,0 0.157		■			■	■			
LCMR1303M0-0300-MP	1,5 0.059	3,0 0.118	12,4 0.488	4,0 0.157		■							
LCMR1304M0-0400-MP	2,0 0.079	4,0 0.157	12,4 0.488	4,0 0.157		■							

Adapters
Clamping units

Accessories and
Spare parts

Workpiece
materials

Please check availability at www.secotools.com / Seco Online Store
* Toolholders have to be modified

Standard

** =
DIN 471
DIN 472
SMS 1581
SMS 1582

Tolerances:
CW = $\pm 0,025/0,001$
IGL = $\pm 0,025/0,001$
S = $\pm 0,05/0,002$

IGL = Distance cutting edge-rear support

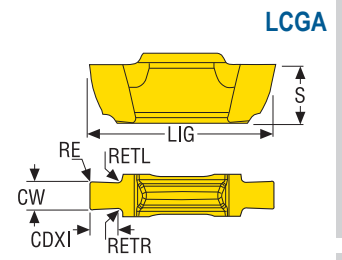

LCGA-FG



Designation	RE	CW	LIG	S	RETR	RETL	CDXI	For circlip	Note	Standard	Grades						Uncoated	
											Coated						883	890
											CP200	CP500	CP600	TGH1050	TGK1500	TGP25		
mm Inch	mm Inch	mm Inch	mm Inch	mm Inch	mm Inch	mm Inch	mm Inch											
LCGA130300-0115-FG	0,0 0.045	1,15 0.488	12,4 0.488	4,0 0.157	0,3 0.012	0,3 0.012	1,4 0.055	1,00	*	**		■						
LCGA130300-0135-FG	-	1,35 0.053	12,4 0.488	4,0 0.157	0,3 0.012	0,3 0.012	1,6 0.063	1,20	*	**		■						
LCGA130301-0165-FG	0,1 0.004	1,65 0.065	12,4 0.488	4,0 0.157	0,3 0.012	0,3 0.012	1,9 0.075	1,50	*	**		■						
LCGA130301-0190-FG	0,1 0.004	1,9 0.075	12,4 0.488	4,0 0.157	0,3 0.012	0,3 0.012	2,15 0.085	1,75	*	**		■						
LCGA130301-0215-FG	0,15 0.006	2,15 0.085	12,4 0.488	4,0 0.157	0,3 0.012	0,3 0.012	2,4 0.094	2,00	*	**		■						
LCGA130302-0265-FG	0,2 0.008	2,65 0.104	12,4 0.488	4,0 0.157	0,2 0.008	0,2 0.008	2,9 0.114	2,50		**		■						
LCGA130301-0300-FG	0,1 0.004	3,0 0.118	12,4 0.488	4,0 0.157	-	-	12,39 0.488	-		**		■						
LCGA130302-0300-FG	0,2 0.008	3,0 0.118	12,4 0.488	4,0 0.157	-	-	12,39 0.488	-		**		■						
LCGA130402-0400-FG	0,2 0.008	4,0 0.157	12,4 0.488	4,0 0.157	-	-	12,39 0.488	-		**		■						

General ISO Turning

Steadyline®

MDT

Mini-Shaft™

Grooving

Parting-off

X4

Adapters
Clamping units

Accessories and
Spare parts

Workpiece
materials

General ISO Turning

LCMF

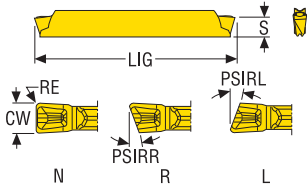

Tolerances:
CW = ±0,05/0,002
LIG = ±0,08/0,003
S = ±0,05/0,002

Please check availability at www.secotools.com / Seco Online Store

IGL = Distance cutting edge-rear support

Steadyline®

LCMF-FT



MDT

Designation	RE	CW	LIG	S	Grades								
					Coated				Uncoated				
	mm Inch	mm Inch	mm Inch	mm Inch	CP200	CP500	CP600	TGH1050	TGK1500	TGP25	TGS2050	883	890
LCMF190202-0200-FT	0,2 0.008	2,0 0.079	18,5 0.728	2,85 0.112		■	■						
LCMF190202-0200-FTR6	0,2 0.008	2,0 0.079	18,5 0.728	2,85 0.112			■						
LCMF190202-0200-FTL6	0,2 0.008	2,0 0.079	18,5 0.728	2,85 0.112			■						
LCMF280202-0200-FT	0,2 0.008	2,0 0.079	28,0 1.102	2,85 0.112		■	■						
LCMF280202-0200-FTR6	0,2 0.008	2,0 0.079	28,0 1.102	2,85 0.112			■						
LCMF280202-0200-FTL6	0,2 0.008	2,0 0.079	28,0 1.102	2,85 0.112			■						

Mini-Shaft™

Grooving

Parting-off

LCMF

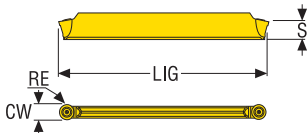

Tolerances:
CW = ±0,05/0,002
LIG = ±0,08/0,003
S = ±0,05/0,002

Please check availability at www.secotools.com / Seco Online Store

IGL = Distance cutting edge-rear support

X4

LCMF-MP



Adapters
Clamping units

Accessories and
Spare parts

Designation	RE	CW	LIG	S	Grades								
					Coated				Uncoated				
	mm Inch	mm Inch	mm Inch	mm Inch	CP200	CP500	CP600	TGH1050	TGK1500	TGP25	TGS2050	883	890
LCMF1902M0-0200-MP	1,0 0.039	2,0 0.079	18,5 0.728	2,85 0.112		■			■				
LCMF2802M0-0200-MP	1,0 0.039	2,0 0.079	28,0 1.102	2,85 0.112		■			■				

Workpiece
materials

Please check availability at www.secotools.com / Seco Online Store

Tolerances: CW = ±0,05/0,002
IGL = ±0,08/0,003
S = ±0,05/0,002
S = ±0,08/0,003

Size: 16/16
30/30

IGL = Distance cutting edge-rear support

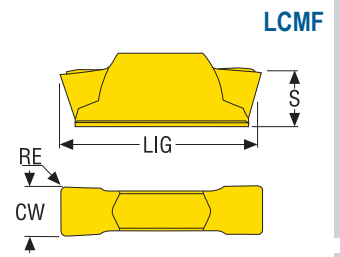

LCMF-FT

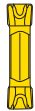

Designation	RE	CW	LIG	S	Grades									
					Coated								Uncoated	
					CP200	CP500	CP600	TGH1050	TGK1500	TGP25	TGS2050	883	890	
mm Inch	mm Inch	mm Inch	mm Inch											
LCMF160302-0300-FT	0,2 0.008	3,0 0.118	15,9 0.626	4,5 0.177	■	■					■			
LCMF160302-0318-FT	0,2 0.008	3,18 0.125	15,9 0.626	4,5 0.177	■	■								
LCMF160304-0300-FT	0,4 0.016	3,0 0.118	15,9 0.626	4,5 0.177		■		■			■			
LCMF160402-0400-FT	0,2 0.008	4,0 0.157	15,9 0.626	4,5 0.177		■					■			
LCMF160404-0400-FT	0,4 0.016	4,0 0.157	15,9 0.626	4,5 0.177	■	■		■			■			
LCMF160408-0400-FT	0,8 0.031	4,0 0.157	15,9 0.626	4,5 0.177		■					■			
LCMF160504-0500-FT	0,4 0.016	5,0 0.197	15,9 0.626	4,5 0.177	■	■		■			■			
LCMF160505-0476-FT	0,5 0.020	4,76 0.187	15,9 0.626	4,5 0.177	■	■								
LCMF160508-0500-FT	0,8 0.031	5,0 0.197	15,9 0.626	4,5 0.177		■					■			
LCMF160604-0600-FT	0,4 0.016	6,0 0.236	15,9 0.626	4,5 0.177		■					■			
LCMF160605-0635-FT	0,5 0.020	6,35 0.250	15,9 0.626	4,5 0.177	■	■								
LCMF160608-0600-FT	0,8 0.031	6,0 0.236	15,9 0.626	4,5 0.177	■	■					■		■	
LCMF160610-0600-FT	1,0 0.039	6,0 0.236	15,9 0.626	4,5 0.177		■					■			
LCMF300804-0800-FT	0,4 0.016	8,0 0.315	29,1 1.146	5,57 0.219		■					■			
LCMF300808-0800-FT	0,8 0.031	8,0 0.315	29,1 1.146	5,57 0.219		■			■	■		■		
LCMF300808-1000-FT	0,8 0.031	10,0 0.394	29,2 1.150	5,57 0.219		■				■				
LCMF300812-0800-FT	1,2 0.047	8,0 0.315	29,1 1.146	5,57 0.219		■			■	■		■		
LCMF300812-1000-FT	1,2 0.047	10,0 0.394	29,2 1.150	5,57 0.219		■						■		

General ISO Turning

Steadyline®

MDT

Mini-Shaft™

Grooving

Parting-off

X4

Adapters
Clamping units

Accessories and
Spare parts

Workpiece
materials

General ISO Turning

LCMF

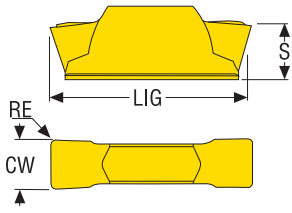

Tolerances:
CW = ±0,05/0,002
LIG = ±0,08/0,003
S = ±0,05/0,002

Please check availability at www.secotools.com / Seco Online Store

LIG = Distance cutting edge-rear support

Steadyline®

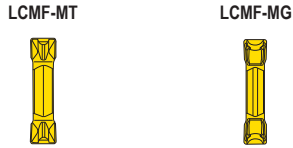

MDT

Designation	RE	CW	LIG	S	Grades								
					Coated						Uncoated		
	mm Inch	mm Inch	mm Inch	mm Inch	CP200	CP500	CP600	TGH1050	TGK1500	TGP25	TGS2050	883	890
LCMF160302-0300-MT	0,2 0.008	3,0 0.118	15,9 0.626	4,5 0.177		■				■			
LCMF160302-0318-MT	0,2 0.008	3,18 0.125	15,9 0.626	4,5 0.177		■							
LCMF160304-0300-MT	0,4 0.016	3,0 0.118	15,9 0.626	4,5 0.177		■			■	■		■	
LCMF160404-0400-MT	0,4 0.016	4,0 0.157	15,9 0.626	4,5 0.177		■			■	■			
LCMF160408-0400-MT	0,8 0.031	4,0 0.157	15,9 0.626	4,5 0.177		■			■	■		■	
LCMF160504-0500-MT	0,4 0.016	5,0 0.197	15,9 0.626	4,5 0.177		■			■	■			
LCMF160505-0476-MT	0,5 0.020	4,76 0.187	15,9 0.626	4,5 0.177		■							
LCMF160508-0500-MT	0,8 0.031	5,0 0.197	15,9 0.626	4,5 0.177		■			■	■		■	
LCMF160604-0600-MT	0,4 0.016	6,0 0.236	15,9 0.626	4,5 0.177		■			■	■			
LCMF160605-0635-MT	0,5 0.020	6,35 0.250	15,9 0.626	4,5 0.177		■						■	
LCMF160608-0600-MT	0,8 0.031	6,0 0.236	15,9 0.626	4,5 0.177		■			■	■		■	
LCMF160610-0600-MT	1,0 0.039	6,0 0.236	15,9 0.626	4,5 0.177		■				■			
LCMF160304-0300-MG	0,4 0.016	3,0 0.118	15,9 0.626	4,5 0.177		■				■			
LCMF160404-0400-MG	0,4 0.016	4,0 0.157	15,9 0.626	4,5 0.177		■				■			
LCMF160504-0500-MG	0,4 0.016	5,0 0.197	15,9 0.626	4,5 0.177		■				■			
LCMF160608-0600-MG	0,8 0.031	6,0 0.236	15,9 0.626	4,5 0.177		■				■			

Accessories and Spare parts

Workpiece materials

Please check availability at www.secotools.com / Seco Online Store
* Toolholders have to be modified

Tolerances:
CW = ±0,05/0,002
IGL = ±0,08/0,003
S = ±0,05/0,002

IGL = Distance cutting edge-rear support

LCMF, LCMR

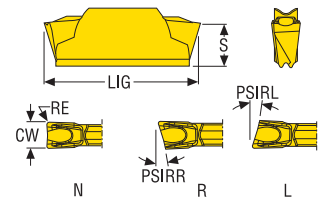

LCMF-MC



LCMR-MC



Designation	RE	CW	LIG	S	PSIRR°	PSIRL°	Note	Grades											
								Coated								Uncoated			
								CP200	CP500	CP600	TGH1050	TGK1500	TGP25	TGS2050	883	890			
	mm Inch	mm Inch	mm Inch	mm Inch															
LCMF160302-0300-MC	0,2 0.008	3,0 0.118	15,9 0.626	4,5 0.177	-	-			■	■									
LCMF160302-0300-MCR6	0,2 0.008	3,0 0.118	15,9 0.626	4,5 0.177	6,0	-	*		■	■									
LCMF160302-0300-MCL6	0,2 0.008	3,0 0.118	15,9 0.626	4,5 0.177	-	6,0	*		■	■									
LCMF160302-0300-MCR15	0,2 0.008	3,0 0.118	15,9 0.626	4,5 0.177	15,0	-	*			■									
LCMF160302-0300-MCL15	0,2 0.008	3,0 0.118	15,9 0.626	4,5 0.177	-	15,0	*			■									
LCMF160304-0300-MC	0,4 0.016	3,0 0.118	15,9 0.626	4,5 0.177	-	-			■	■					■				
LCMF160402-0400-MC	0,2 0.008	4,0 0.157	15,9 0.626	4,5 0.177	-	-			■	■									
LCMF160402-0400-MCR6	0,2 0.008	4,0 0.157	15,9 0.626	4,5 0.177	6,0	-	*		■	■									
LCMF160402-0400-MCL6	0,2 0.008	4,0 0.157	15,9 0.626	4,5 0.177	-	6,0	*			■									
LCMF160402-0400-MCR15	0,2 0.008	4,0 0.157	15,9 0.626	4,5 0.177	15,0	-	*			■									
LCMF160402-0400-MCL15	0,2 0.008	4,0 0.157	15,9 0.626	4,5 0.177	-	15,0	*			■									
LCMF160404-0400-MC	0,4 0.016	4,0 0.157	15,9 0.626	4,5 0.177	-	-			■	■					■				
LCMF160504-0500-MC	0,4 0.016	5,0 0.197	15,9 0.626	4,5 0.177	-	-			■	■					■				
LCMF160604-0600-MC	0,4 0.016	6,0 0.236	15,9 0.626	4,5 0.177	-	-			■	■					■				
LCMF160608-0600-MC	0,8 0.031	6,0 0.236	15,9 0.626	4,5 0.177	-	-			■						■				
LCMR160302-0300-MC	0,2 0.008	3,0 0.118	15,9 0.626	4,5 0.177	-	-				■									
LCMR160404-0400-MC	0,4 0.016	4,0 0.157	15,9 0.626	4,5 0.177	-	-				■									
LCMR160504-0500-MC	0,4 0.016	5,0 0.197	15,9 0.626	4,5 0.177	-	-				■									
LCMR160604-0600-MC	0,4 0.016	6,0 0.236	15,9 0.626	4,5 0.177	-	-				■									

General ISO Turning

Steadyline®

MDT

Mini-Shaft™

Grooving

Parting-off

X4

Adapters
Clamping units

Accessories and
Spare parts

Workpiece
materials

General ISO Turning

LCMF

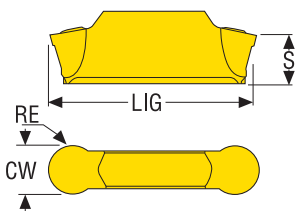

Tolerances: CW = ±0,05/0,002
IGL = ±0,08/0,003
S = ±0,05/0,002
S = ±0,08/0,003

Size: 16/16
30/30

Please check availability at www.secotools.com / Seco Online Store

IGL = Distance cutting edge-rear support

Steadyline®



MDT

Designation	RE	CW	LIG	S	Grades								
					Coated				Uncoated				
	mm Inch	mm Inch	mm Inch	mm Inch	CP200	CP500	CP600	TGH1050	TGK1500	TGP25	TGS2050	883	890
LCMF1603M0-0300-MP	1,5 0.059	3,0 0.118	17,0 0.669	4,3 0.169	■	■		■	■	■		■	■
LCMF160300-0318-MP	1,59 0.063	3,18 0.125	16,6 0.654	4,36 0.172	■	■						■	
LCMF1604M0-0400-MP	2,0 0.079	4,0 0.157	17,1 0.673	4,25 0.167	■	■		■	■	■		■	■
LCMF1605M0-0500-MP	2,5 0.098	5,0 0.197	17,8 0.701	4,17 0.164	■	■		■	■	■		■	■
LCMF160500-0476-MP	2,38 0.094	4,76 0.187	17,7 0.697	4,17 0.164	■	■							■
LCMF1606M0-0600-MP	3,0 0.118	6,0 0.236	18,0 0.709	4,12 0.162	■	■		■	■	■		■	■
LCMF160600-0635-MP	3,18 0.125	6,35 0.250	17,6 0.693	4,19 0.165	■	■						■	
LCMF3008M0-0800-MP	4,0 0.157	8,0 0.315	30,1 1.185	5,42 0.213		■			■	■		■	■
LCMF3008M0-1000-MP	5,0 0.197	10,0 0.394	30,1 1.185	5,49 0.216	■	■				■			

Mini-Shaft™

Grooving

Parting-off

X4

Adapters
Clamping units

Accessories and
Spare parts

Workpiece
materials

Please check availability at www.secotools.com / Seco Online Store

Tolerances: CW = ±0,05/0,002
IGL = ±0,08/0,003
S = ±0,05/0,002
S = ±0,08/0,003

Size: 16/16
30/30

IGL = Distance cutting edge-rear support

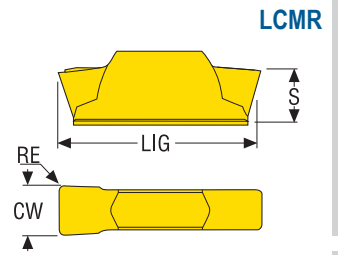

LCMR-FT



LCMR-MT



Designation	RE	CW	LIG	S	Grades									
					Coated								Uncoated	
					CP200	CP500	CP600	TGH1050	TGK1500	TGP25	TGS2050	883	890	
mm Inch	mm Inch	mm Inch	mm Inch											
LCMR160304-0300-FT	0,4 0.016	3,0 0.118	15,9 0.626	4,5 0.177	■	■					■			
LCMR160402-0400-FT	0,2 0.008	4,0 0.157	15,9 0.626	4,5 0.177		■								
LCMR160404-0400-FT	0,4 0.016	4,0 0.157	15,9 0.626	4,5 0.177	■	■					■			
LCMR160504-0500-FT	0,4 0.016	5,0 0.197	15,9 0.626	4,5 0.177	■	■					■			
LCMR160608-0600-FT	0,8 0.031	6,0 0.236	15,9 0.626	4,5 0.177	■	■					■			
LCMR300808-0800-FT	0,8 0.031	8,0 0.315	29,1 1.146	5,57 0.219		■					■	■		
LCMR300808-1000-FT	0,8 0.031	10,0 0.394	29,2 1.150	5,57 0.219		■								
LCMR300812-0800-FT	1,2 0.047	8,0 0.315	29,1 1.146	5,57 0.219		■								
LCMR300812-1000-FT	1,2 0.047	10,0 0.394	29,2 1.150	5,57 0.219		■								
LCMR160304-0300-MT	0,4 0.016	3,0 0.118	15,9 0.626	4,5 0.177		■					■	■		
LCMR160404-0400-MT	0,4 0.016	4,0 0.157	15,9 0.626	4,5 0.177		■					■			
LCMR160408-0400-MT	0,8 0.031	4,0 0.157	15,9 0.626	4,5 0.177								■		
LCMR160504-0500-MT	0,4 0.016	5,0 0.197	15,9 0.626	4,5 0.177		■					■			
LCMR160508-0500-MT	0,8 0.031	5,0 0.197	15,9 0.626	4,5 0.177								■		
LCMR160608-0600-MT	0,8 0.031	6,0 0.236	15,9 0.626	4,5 0.177		■					■	■		

General ISO Turning

Steadyline®

MDT

Mini-Shaft™

Grooving

Parting-off

X4

Adapters and Clamping units

Accessories and Spare parts

Workpiece materials

General ISO Turning

LCMR

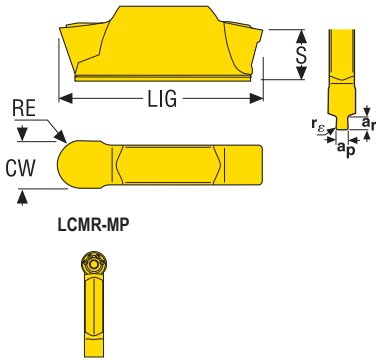

Tolerances: CW = ±0,05/0,002
IGL = ±0,08/0,003
S = ±0,05/0,002
S = ±0,08/0,003

Size: 16/16
30/30

Please check availability at www.secotools.com / Seco Online Store

IGL = Distance cutting edge-rear support

Steadyline®

MDT

Designation	RE	CW	LIG	S	Grades								
					Coated						Uncoated		
	mm Inch	mm Inch	mm Inch	mm Inch	CP200	CP500	CP600	TGH1050	TGK1500	TGP25	TGS2050	883	890
LCMR1603M0-0300-MP	1,5 0.059	3,0 0.118	17,0 0.669	4,3 0.169	■	■				■		■	
LCMR1604M0-0400-MP	2,0 0.079	4,0 0.157	17,1 0.673	4,25 0.167	■	■				■		■	
LCMR1605M0-0500-MP	2,5 0.098	5,0 0.197	17,8 0.701	4,17 0.164	■	■				■		■	
LCMR1606M0-0600-MP	3,0 0.118	6,0 0.236	18,0 0.709	4,12 0.162	■	■				■		■	
LCMR3008M0-0800-MP	4,0 0.157	8,0 0.315	30,1 1.185	5,42 0.213		■				■		■	
LCMR3008M0-1000-MP	5,0 0.197	10,0 0.394	30,1 1.185	5,49 0.216		■				■			

Mini-Shaft™

Grooving

Parting-off

X4

Adapters
Clamping units

Accessories and
Spare parts

Workpiece
materials

Please check availability at www.secotools.com / Seco Online Store

Tolerances:
CW = $\pm 0,025/0,001$
IGL = $\pm 0,025/0,001$
S = $\pm 0,05/0,002$

IGL = Distance cutting edge-rear support

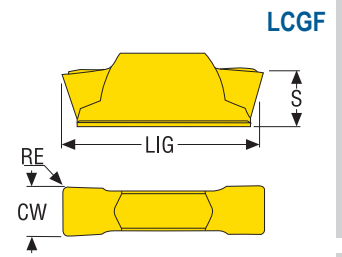

LCGF-GG



LCGF-GS



Designation	RE	CW	LIG	S	Grades									
					Coated								Uncoated	
					CP200	CP500	CP600	TGH1050	TGK1500	TGF25	TGS2050	883	890	
LCGF160302-0300-GG	0,2 0.008	3,0 0.118	16,6 0.654	4,25 0.167		■								
LCGF160402-0400-GG	0,2 0.008	4,0 0.157	16,6 0.654	4,25 0.167		■								
LCGF160502-0500-GG	0,2 0.008	5,0 0.197	17,1 0.673	4,15 0.163		■								
LCGF160604-0600-GG	0,4 0.016	6,0 0.236	17,4 0.685	4,2 0.165		■								
LCGF300804-0800-GG	0,4 0.016	8,0 0.315	29,0 1.142	5,55 0.219		■								
LCGF160302-0300-GS	0,2 0.008	3,0 0.118	16,6 0.654	4,25 0.167									■	
LCGF160402-0400-GS	0,2 0.008	4,0 0.157	16,6 0.654	4,25 0.167									■	
LCGF160502-0500-GS	0,2 0.008	5,0 0.197	17,1 0.673	4,15 0.163									■	
LCGF160604-0600-GS	0,4 0.016	6,0 0.236	17,4 0.685	4,2 0.165									■	
LCGF300804-0800-GS	0,4 0.016	8,0 0.315	29,0 1.142	5,55 0.219									■	

General ISO Turning
Steadyline®
MDT
Mini-Shaft™
Grooving
Parting-off
X4
Adapters Clamping units
Accessories and Spare parts
Workpiece materials

General ISO Turning

LCGF

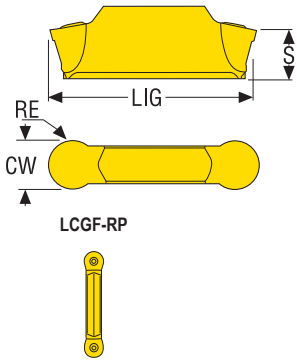

Tolerances: CW = ±0,02/0,0008
IGL = ±0,04/0,0016
S = ±0,05/0,002
S = ±0,08/0,003

Size: 16/16
30/30

Please check availability at www.secotools.com / Seco Online Store

IGL = Distance cutting edge-rear support

Steadyline®

MDT

Designation	RE	CW	LIG	S	Grades								
					Coated						Uncoated		
	mm Inch	mm Inch	mm Inch	mm Inch	CP200	CP500	CP600	TGH1050	TGK1500	TGP25	TGS2050	883	890
LCGF1603M0-0300-RP	1,5 0.059	3,0 0.118	17,0 0.669	4,3 0.169	■							■	
LCGF160300-0318-RP	1,59 0.063	3,18 0.125	16,6 0.654	4,36 0.172	■							■	
LCGF1604M0-0400-RP	2,0 0.079	4,0 0.157	17,1 0.673	4,25 0.167	■							■	
LCGF1605M0-0500-RP	2,5 0.098	5,0 0.197	17,8 0.701	4,17 0.164	■							■	
LCGF160500-0476-RP	2,38 0.094	4,76 0.187	17,7 0.697	4,17 0.164	■							■	
LCGF1606M0-0600-RP	3,0 0.118	6,0 0.236	18,0 0.709	4,12 0.162	■							■	
LCGF3008M0-0800-RP	4,0 0.157	8,0 0.315	30,1 1.185	5,42 0.213	■							■	

Mini-Shaft™

Grooving

Parting-off

X4

Adapters
Clamping units

Accessories and
Spare parts

Workpiece
materials

Please check availability at www.secotools.com / Seco Online Store
* Toolholders have to be modified

Standard

** =
DIN 471
DIN 472
SMS 1581
SMS 1582

Tolerances:
CW = ±0,025/0,001
IGL = ±0,025/0,001
S = ±0,05/0,002

IGL = Distance cutting edge-rear support

LCGN, LCGF – Radial grooves

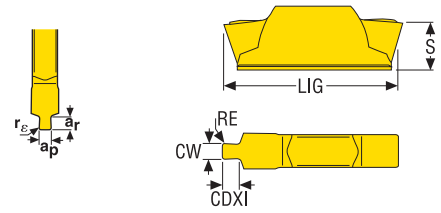

LCGN-FG



LCGF-FG



Designation	RE	CW	LIG	S	CDXI	For circlip	Note	Standard	Grades									
									Coated						Uncoated			
									CP200	CP500	CP600	TGH1050	TCK1500	TGP25	TGS2050	883	890	
mm Inch	mm Inch	mm Inch	mm Inch	mm Inch	mm Inch													
LCGN160300-0115-FG	0,0 0.000	1,15 0.045	16,6 0.654	4,5 0.177	1,4 0.055	1,00	*	**		■								
LCGN160300-0135-FG	0,0 0.000	1,35 0.053	16,6 0.654	4,5 0.177	1,6 0.063	1,20	*	**		■								
LCGN160301-0165-FG	0,1 0.004	1,65 0.065	16,6 0.654	4,5 0.177	1,85 0.073	1,50	*	**		■								
LCGN160301-0190-FG	0,1 0.004	1,9 0.075	16,6 0.654	4,5 0.177	2,1 0.083	1,75	*	**		■								
LCGN160301-0215-FG	0,1 0.004	2,15 0.085	16,6 0.654	4,5 0.177	2,3 0.091	2,00	*	**		■								
LCGN160302-0265-FG	0,2 0.008	2,65 0.104	16,6 0.654	4,5 0.177	-	2,50		**		■								
LCGN160302-0300-FG	0,2 0.008	3,0 0.118	16,6 0.654	4,5 0.177	-	-		**		■								
LCGN160302-0320-FG	0,2 0.008	3,2 0.126	16,6 0.654	4,5 0.177	-	3,00		**		■								
LCGN160302-0340-FG	0,2 0.008	3,4 0.134	16,6 0.654	4,5 0.177	-	-		**		■								
LCGN160402-0400-FG	0,2 0.008	4,0 0.157	16,6 0.654	4,5 0.177	-	-		**		■								
LCGN160402-0420-FG	0,2 0.008	4,2 0.165	16,6 0.654	4,5 0.177	-	4,00		**		■								
LCGN160402-0440-FG	0,2 0.008	4,4 0.173	16,6 0.654	4,5 0.177	-	-		**		■								
LCGN160502-0500-FG	0,2 0.008	5,0 0.197	17,1 0.673	4,5 0.177	-	-		**		■								
LCGN160502-0520-FG	0,2 0.008	5,2 0.205	17,1 0.673	4,5 0.177	-	5,00		**		■								
LCGN160602-0600-FG	0,2 0.008	6,0 0.236	17,6 0.693	4,5 0.177	-	-		**		■								
LCGN160602-0635-FG	0,2 0.008	6,35 0.250	17,6 0.693	4,5 0.177	-	-		**		■								
LCGF160301-0300-FG	0,1 0.004	3,0 0.118	16,6 0.654	4,5 0.177	14,0 0.551	-				■								

General ISO Turning

Steadyline®

MDT

Mini-Shaft™

Grooving

Parting-off

X4

Adapters
Clamping units

Accessories and
Spare parts

Workpiece
materials

General ISO Turning

LCGN – O-ring

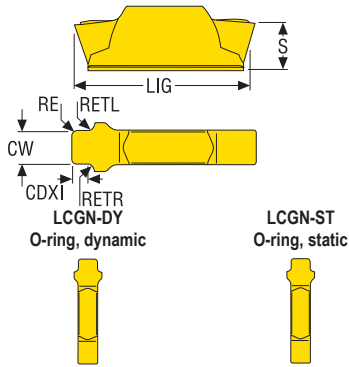

Tolerances:
 CW = $\pm 0,025/0,001$
 IGL = $\pm 0,025/0,001$
 S = $\pm 0,05/0,002$

IGL = Distance cutting edge-rear support

Please check availability at www.secotools.com / Seco Online Store

Standard
 * =
 SMS 1588, BS 4518
 ** =
 ISO 3601, DIN 3771, BS 1806

Steadyline®

MDT

Designation	RE	CW	LIG	S	RETR	RETL	CDXI	For O-ring	Standard	Grades						Uncoated		
										Coated								
										CP200	CP500	CP600	TGH1050	TGK1500	TGP25	TGS2050	883	890
mm Inch	mm Inch	mm Inch	mm Inch	mm Inch	mm Inch	mm Inch	mm Inch	mm Inch										
LCGN160305-0180-DY	0,5 0.020	2,4 0.094	16,6 0.654	4,5 0.177	0,3 0.012	0,3 0.012	1,55 0.061	1,80 0.071	**	■								
LCGN160405-0240-DY	0,5 0.020	3,3 0.130	16,6 0.654	4,5 0.177	0,3 0.012	0,3 0.012	2,0 0.079	2,40 0.094	*	■								
LCGN160405-0265-DY	0,5 0.020	3,6 0.142	16,6 0.654	4,5 0.177	0,3 0.012	0,3 0.012	2,3 0.091	2,65 0.104	**	■								
LCGN160410-0300-DY	1,0 0.039	4,1 0.161	16,6 0.654	4,5 0.177	0,3 0.012	0,3 0.012	2,5 0.098	3,00 0.118	*	■								
LCGN160305-0160-ST	0,5 0.020	2,4 0.094	16,6 0.654	4,5 0.177	0,3 0.012	0,3 0.012	1,2 0.047	1,60 0.063	*	■								
LCGN160305-0240-ST	0,5 0.020	3,2 0.126	16,6 0.654	4,5 0.177	0,3 0.012	0,3 0.012	1,9 0.075	2,40 0.094	*	■								
LCGN160410-0300-ST	1,0 0.039	3,8 0.150	16,6 0.654	4,5 0.177	0,3 0.012	0,3 0.012	2,4 0.094	3,00 0.118	*	■								
LCGN160507-0355-ST	0,75 0.030	4,8 0.189	17,1 0.673	4,5 0.177	0,3 0.012	0,3 0.012	2,8 0.110	3,55 0.140	**	■								

Mini-Shaft™

Grooving

Parting-off

X4

Adapters
Clamping units

Accessories and
Spare parts

Workpiece
materials

Please check availability at www.secotools.com / Seco Online Store
* Toolholders have to be modified

Tolerances:
IGL = $\pm 0,025/0,001$
S = $\pm 0,05/0,002$

IGL = Distance cutting edge-rear support

Right-hand version shown

LCGN – Full radius grooving

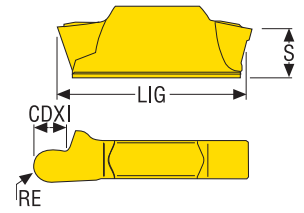

LCGN-R-R



LCGN-L-R



LCGN-R



Designation	RE	LIG	S	CDXI	For radius	Note	Grades								
							Coated				Uncoated				
	mm Inch	mm Inch	mm Inch	mm Inch	mm Inch		CP200	CP500	CP600	TGH1050	TGK1500	TGP25	TGS2050	883	890
LCGN1603M0-0100R-R	1,0 0.039	16,6 0.654	4,5 0.177	2,7 0.106	1,0 0.039	*		■							
LCGN1603M0-0120R-R	1,2 0.047	16,6 0.654	4,5 0.177	2,7 0.106	1,2 0.047	*		■							
LCGN1603M0-0100L-R	1,0 0.039	16,6 0.654	4,5 0.177	2,7 0.106	1,0 0.039	*		■							
LCGN1603M0-0120L-R	1,2 0.047	16,6 0.654	4,5 0.177	2,7 0.106	1,2 0.047	*		■							
LCGN1603M0-0150-R	1,5 0.059	16,6 0.654	4,5 0.177	-	1,5 0.059			■							
LCGN1604M0-0200-R	2,0 0.079	16,6 0.654	4,5 0.177	-	2,0 0.079			■							
LCGN1606M0-0300-R	3,0 0.118	17,6 0.693	4,5 0.177	-	3,0 0.118			■							

General ISO Turning

Steadyline®

MDT

Mini-Shaft™

Grooving

Parting-off

X4

Adapters
Clamping units

Accessories and
Spare parts

Workpiece
materials

General ISO Turning

LCGN-D76

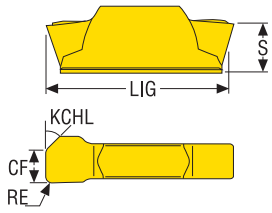

Tolerances:
IGL = $\pm 0,025/0,001$
S = $\pm 0,05/0,002$

Please check availability at www.secotools.com / Seco Online Store
* Toolholders have to be modified

IGL = Distance cutting edge-rear support

Right-hand version shown

Steadyline®

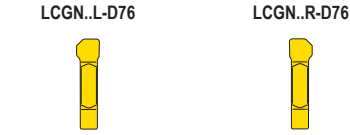

MDT

Designation	RE	CF	LIG	S	For max pitch	KCHR°	KCHL°	Note	Grades									
									Coated							Uncoated		
									CP200	CP500	CP600	TGH1050	TGK1500	TGP25	TGS2050	883	890	
	mm Inch	mm Inch	mm Inch	mm Inch														
LCGN160306-0100R-D76	0,6 0.024	2,2 0.087	16,6 0.654	4,5 0.177	1,0 0.039	0,0	45,0	*		■								
LCGN160306-0100L-D76	0,6 0.024	2,2 0.087	16,6 0.654	4,5 0.177	1,0 0.039	45,0	0,0	*		■								
LCGN160507-0150R-D76	0,75 0.030	3,2 0.126	17,1 0.673	4,5 0.177	1,5 0.059	0,0	45,0			■								
LCGN160507-0150L-D76	0,75 0.030	3,2 0.126	17,1 0.673	4,5 0.177	1,5 0.059	45,0	0,0			■								
LCGN160610-0200R-D76	1,0 0.039	4,6 0.181	17,6 0.693	4,5 0.177	2,0 0.079	0,0	45,0			■								
LCGN160610-0200L-D76	1,0 0.039	4,6 0.181	17,6 0.693	4,5 0.177	2,0 0.079	45,0	0,0			■								

Mini-Shaft™

Grooving

Parting-off

X4

Adapters
Clamping units

Accessories and
Spare parts

Workpiece
materials

Please check availability at www.secotools.com / Seco Online Store

Tolerances:
IGL = $\pm 0,025/0,001$
RE = $\pm 0,025/0,001$

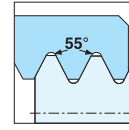

LCGN – Partial profile 55°

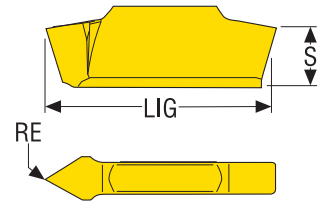

LCGN...-.55



Designation	RE	LIG	S	Pitch mm	TPI	Grades								
						Coated				Uncoated				
						CP200	CP500	CP600	TGH1050	TGK1500	TGP25	TGS2050	883	890
LCGN1603-A55	0,08 0.003	16,6 0.654	4,5 0.177	0,5-1,5	48,0-16,0		■							
LCGN1603-G55	0,18 0.007	16,6 0.654	4,5 0.177	1,75-3,0	14,0-8,0		■							

Please check availability at www.secotools.com / Seco Online Store

Tolerances:
IGL = $\pm 0,025/0,001$
RE = $\pm 0,025/0,001$

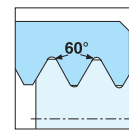

LCGN – Partial profile 60°

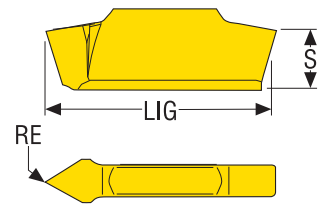

LCGN...-.60



Designation	RE	LIG	S	Pitch mm	TPI	Grades								
						Coated				Uncoated				
						CP200	CP500	CP600	TGH1050	TGK1500	TGP25	TGS2050	883	890
LCGN1603-A60	0,08 0.003	16,6 0.654	4,5 0.177	0,5-1,5	48,0-16,0		■							
LCGN1603-G60	0,18 0.007	16,6 0.654	4,5 0.177	1,75-3,0	14,0-8,0		■							

General ISO Turning

Steadyline®

MDT

Mini-Shaft™

Grooving

Parting-off

X4

Adapters
Clamping units

Accessories and
Spare parts

Workpiece
materials

General ISO Turning

LCGN – ISO Metric

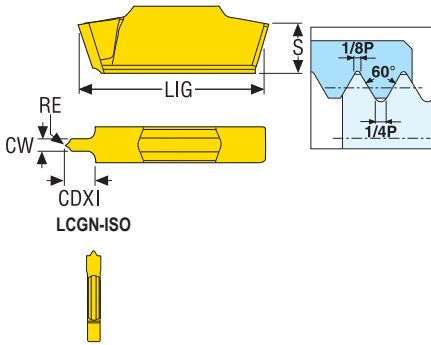

Tolerances:
IGL = $\pm 0,025/0,001$
S = $\pm 0,05/0,002$

Please check availability at www.secotools.com / Seco Online Store
* Toolholders have to be modified

Steadyline®

MDT

Mini-Shaft™

Grooving

Parting-off

X4

Adapters
Clamping units

Accessories and
Spare parts

Workpiece
materials

Designation	RE	CW	LIG	S	CDXI	Pitch	Note	Grades								
								Coated					Uncoated			
	mm <i>Inch</i>	mm <i>Inch</i>	mm <i>Inch</i>	mm <i>Inch</i>	mm <i>Inch</i>	mm <i>Inch</i>		CP200	CP500	CP600	TGH1050	TGK1500	TGP25	TGS2050	883	890
LCGN1603-E0.5ISO	0,07 0.003	0,75 0.030	16,6 0.654	4,5 0.177	1,9 0.075	0,5 0.500	*		■							
LCGN1603-E0.8ISO	0,11 0.004	1,2 0.047	16,6 0.654	4,5 0.177	3,0 0.118	0,8 0.800	*		■							
LCGN1603-E1.0ISO	0,13 0.005	1,5 0.059	16,6 0.654	4,5 0.177	3,75 0.148	1,0 1.000	*		■							
LCGN1603-E1.25ISO	0,17 0.007	1,88 0.074	16,6 0.654	4,5 0.177	4,2 0.165	1,25 1.250	*		■							
LCGN1603-E1.5ISO	0,21 0.008	2,4 0.094	16,6 0.654	4,5 0.177	0,92 0.036	1,5 1.500			■							

Tip sizes, see page(s) 134
Edge preparation, see page(s) 131
Please check availability at www.secotools.com / Seco Online Store

Tolerances:
CW = $\pm 0,025/0,001$
IGL = $\pm 0,04/0,0016$
S = $\pm 0,05/0,002$
RE = $\pm 0,025/0,001$

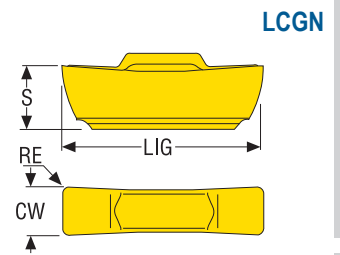

LCGN-LF



Designation	RE	CW	IGL	S	Coated	Grades		
						Uncoated		
	mm Inch	mm Inch	mm Inch	mm Inch	CBN170C	CBN010	CBN170	CBN200
LCGN130304-0300S-LF	0,4 0.016	3,0 0.118		4,0 0.157				■
LCGN1303040300S01025LF	0,4 0.016	3,0 0.118		4,0 0.157		■		
LCGN130404-0400S-LF	0,4 0.016	4,0 0.157		4,0 0.157				■

Tip sizes, see page(s) 134
Edge preparation, see page(s) 131
Please check availability at www.secotools.com / Seco Online Store

Tolerances:
CW = $\pm 0,025/0,001$
IGL = $\pm 0,04/0,0016$
S = $\pm 0,05/0,002$
RE = $\pm 0,025/0,001$

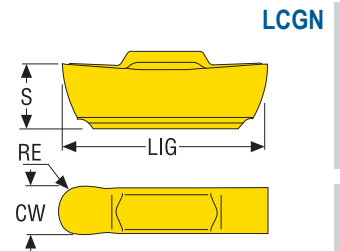

LCGN...M0-LF



Designation	RE	CW	IGL	S	Coated	Grades		
						Uncoated		
	mm Inch	mm Inch	mm Inch	mm Inch	CBN170C	CBN010	CBN170	CBN200
LCGN1303M00300S01025LF	1,5 0.059	3,0 0.118		4,0 0.157		■		
LCGN1304M00400S01025LF	2,0 0.079	4,0 0.157		4,0 0.157		■		

General ISO Turning
Steadyline®
MDT
Mini-Shaft™
Grooving
Parting-off
X4
Adapters Clamping units
Accessories and Spare parts
Workpiece materials

LCGN

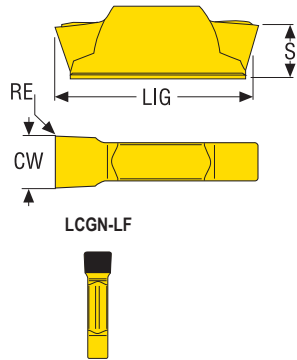

Tolerances:
CW = $\pm 0,025/0,001$
LIG = $\pm 0,04/0,0016$
S = $\pm 0,05/0,002$
RE = $\pm 0,025/0,001$

Tip sizes, see page(s) 134
Edge preparation, see page(s) 131
Please check availability at www.secotools.com / Seco Online Store

General ISO Turning

Steadyline®

MDT

Mini-Shaft™

Grooving

Parting-off

X4

Adapters
Clamping units

Accessories and
Spare parts

Workpiece
materials

Designation	RE	CW	LIG	S	Coated	Grades			
						Uncoated			
	mm Inch	mm Inch	mm Inch	mm Inch	CBN170C	CBN010	CBN170	CBN200	
LCGN160304-0300E-LF	0,4 0.016	3,0 0.118		4,5 0.177		■			
LCGN160304-0300E25-LF	0,4 0.016	3,0 0.118		4,5 0.177			■		
LCGN160304-0300S-LF	0,4 0.016	3,0 0.118		4,5 0.177				■	
LCGN160304-0300S01025LF	0,4 0.016	3,0 0.118		4,5 0.177		■			
LCGN160404-0400E-LF	0,4 0.016	4,0 0.157		4,5 0.177		■			
LCGN160404-0400E25-LF	0,4 0.016	4,0 0.157		4,5 0.177			■		
LCGN160404-0400S-LF	0,4 0.016	4,0 0.157		4,5 0.177				■	
LCGN160404-0400S01025LF	0,4 0.016	4,0 0.157		4,5 0.177		■			
LCGN160504-0500S-LF	0,4 0.016	5,0 0.197		4,5 0.177				■	
LCGN160504-0500S01025LF	0,4 0.016	5,0 0.197		4,5 0.177		■			
LCGN160604-0600S-LF	0,4 0.016	6,0 0.236		4,5 0.177				■	
LCGN160604-0600S01025LF	0,4 0.016	6,0 0.236		4,5 0.177		■			

Tip sizes, see page(s) 134
Edge preparation, see page(s) 131
Please check availability at www.secotools.com / Seco Online Store

Tolerances:
CW = $\pm 0,025/0,001$
IGL = $\pm 0,04/0,0016$
S = $\pm 0,05/0,002$
RE = $\pm 0,025/0,001$

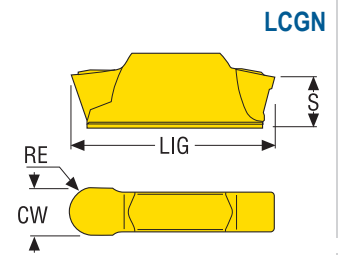

LCGN...M0-LF



Designation	RE	CW	IGL	S	Coated	Grades			
						Uncoated			
	mm Inch	mm Inch	mm Inch	mm Inch	CBN170C	CBN010	CBN170	CBN200	
LCGN1603M0-0300E25-LF	1,5 0.059	3,0 0.118		4,4 0.173	■	■	■		
LCGN1603M0-0300S-LF	1,5 0.059	3,0 0.118		4,4 0.173				■	
LCGN1603M0-0300S01025LF	1,5 0.059	3,0 0.118		4,4 0.173		■			
LCGN1604M0-0400E25-LF	2,0 0.079	4,0 0.157		4,35 0.171		■	■		
LCGN1604M0-0400S-LF	2,0 0.079	4,0 0.157		4,35 0.171				■	
LCGN1604M0-0400S01025LF	2,0 0.079	4,0 0.157		4,35 0.171		■			
LCGN1605M0-0500E25-LF	2,5 0.098	5,0 0.197		4,3 0.169	■	■	■		
LCGN1605M0-0500S-LF	2,5 0.098	5,0 0.197		4,3 0.169				■	
LCGN1605M0-0500S01025LF	2,5 0.098	5,0 0.197		4,3 0.169		■			
LCGN1606M0-0600E25-LF	3,0 0.118	6,0 0.236		4,2 0.165		■			
LCGN1606M0-0600S-LF	3,0 0.118	6,0 0.236		4,2 0.165				■	
LCGN1606M0-0600S01025LF	3,0 0.118	6,0 0.236		4,2 0.165		■			

General ISO Turning

Steadyline®

MDT

Mini-Shaft™

Grooving

Parting-off

X4

Adapters
Clamping units

Accessories and
Spare parts

Workpiece
materials



Mini-Shaft™

The Seco Mini-Shaft™ system consists of holders and inserts for internal turning, grooving, precision grooving, profiling, backfacing and threading. It can be used in holes as small as $\varnothing 8$ mm/ 0.315 inch (Mini-Shaft™ 08) or $\varnothing 11$ mm/ 0.433 inch (Mini-Shaft™ 11). Seco Mini-Shaft™ also features a unique connection, with a double serration, making the connection both stable and secure. It also gives very good repeatability (± 0.02 mm/ 0.0008 inch).

- All toolholders are used for both R and L-handed inserts
- To be used in holes as small as $\varnothing 8$ mm/ 0.315 inch (Mini-Shaft™ 08) or $\varnothing 11$ mm/ 0.433 inch (Mini-Shaft™ 11).
- Through coolant possibility.

General information

General information

Seco Mini-Shaft™ consists of holders and inserts for internal turning, grooving, precision grooving, profiling, backfacing and threading. To be used in holes as small as $\varnothing 8$ mm *0.315 inch* (Mini-Shaft™ 08) or 11 mm *0.433 inch* (Mini-Shaft™ 11).

Seco Mini-Shaft™ features a new type of joint, with a double serration, which makes the connection both stable and secure. It also gives very good repeatability ($\pm 0,02$ mm *0.0008 inch*).

All toolholders are used for both R and L -handed inserts, and have through coolant possibility.

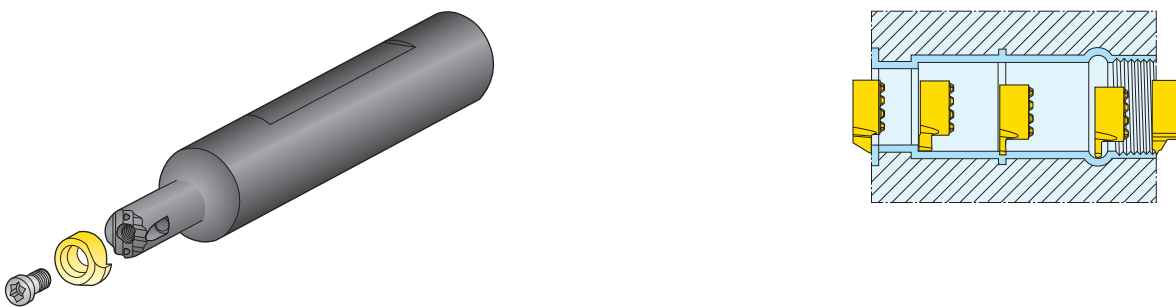

Toolholders

General ISO Turning

Steadyline®

MDT

Mini-Shaft™

Grooving

Parting-off

X4

Adapters
Clamping units

Accessories and
Spare parts

Workpiece
materials





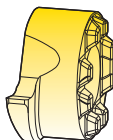

A	12	G	-	S	G	X	N	08	-	20	-	R
1	2	3		4	5	6	7	8		9		10

1. Toolholder type	2. Shank diameter	3. Tool length
<p>A = Steel with coolant passage</p> <p>S = Solid steel</p> <p>E = Solid carbide with brazed* cutting head and coolant passage</p> <p>* Brazed or equivalent</p>	<p>DMM</p> <p>12 = 12 mm</p>	<p>OAL</p> <p>G = 90 mm H = 100 mm</p>
4. Insert clamping	5. Toolholder setting angle	6. Maximum grooving/turning depth
S = Screw	<p>G = 0° F = 90°</p>	X = Special
7. Version	8. Insert size	9. Extension length
N = Neutral version	<p>DCINN</p> <p>08 = Insert size</p>	<p>LH</p> <p>20 = 20 mm</p>
10. Internal designation		
R = Round		

Inserts, turning and grooving

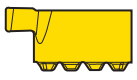
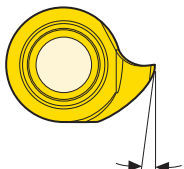
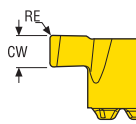
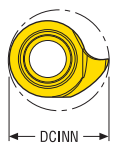

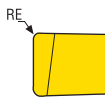
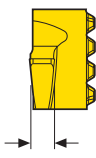
L	C	E	X	08	04	02	-	0150	R	-	FG
1	2	3	4	5	6	7		8	9		10

1. Shape  <p>L = Insert shape</p>		2. Front clearance angle  <p>C = 7°</p>	
3. Tolerances  <p>Tolerance class E</p> <p>Tolerance ± mm CW 0,025 RE 0,025</p>		4. Insert type <p>X = Special</p>	
5. Insert size 	6. Thickness  <p>04 = 3,95 mm 05 = 4,85 mm</p>		7. Corner radius 
8. Cutting edge width  <p>0075 = 0,75 mm 0080 = 0,80 mm 0090 = 0,90 mm etc.</p>	9. Version <p>R</p>  <p>L</p> 		10. Insert type code <p>FG = For locking R = Full radius etc.</p>

General ISO Turning
Steadyline®
MDT
Mini-Shaft™
Grooving
Parting-off
X4
Adapters Clamping units
Accessories and Spare parts
Workpiece materials

Inserts, threading

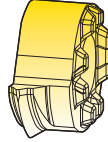

L	C	E	X	11	05	- 1.5	ISO	R
1	2	3	4	5	6	7	8	9

1. Shape		2. Front clearance angle					
	L = Insert shape		C = 7°				
3. Tolerances			4. Insert type				
	Tolerance class	Tolerance ± mm					
E	CW	RE	X = Special				
	0,025	0,025					
5. Insert size	6. Thickness	7. Pitch					
		Full profile (mm)	1.0	1.5	2.0	2.5	3.0
	04 = 3,95 mm 05 = 4,85 mm	Part profile (mm)	A	= 0,50 - 0,75			
			AG	= 0,75 - 1,25			
			G	= 1,25 - 1,75			
		Full profile (TPI)	14	19			
		etc.					
8. Thread profile		9. Version					
Thread =		R			L		
60	= V profile 60°						
ISO	= ISO, metric						
W	= Whitworth, BSW						
TR	= Trapezoidal, DIN 103						
etc.							

General ISO Turning
Steadyline®
MDT
Mini-Shaft™
Grooving
Parting-off
X4
Adapters
Clamping units
Accessories and
Spare parts
Workpiece
materials

Technical information

Tool blocks, adapters

Holders should be mounted in standard turrets. Sometimes there is a need for additional set-up devices, such as tool blocks and adapters.

Shown opposite is the Seco solution for bars to be mounted into a turret for standard square shanks 131-.. to be used together with fully cylindrical shanks (-R) and shanks with flats.

Adapters SL16.. to be used with shanks with flats.

Please see page(s) 984.



Collet chucks

Fully cylindrical shanks (-R) can also be mounted in collet chucks.

- Use collets or reduction sleeves for hydraulic chucks
- Round shanks combined with collets can prevent vibrations
- Shanks with flats may not be used in collets – as there is a risk of damaging the collet



Accessories

Setting gauge	Part No.		
	LCEX	0804-N	■
		1105-N	■

Set-up device for cylindrical shanks

To obtain an accurate centering of the cutting edge use a set-up device.



General ISO Turning

Steadyline®

MDT

Mini-Shaft™

Grooving

Parting-off

X4

Adapters
Clamping units

Accessories and
Spare parts

Workpiece
materials

	SMG	CW = 0.75-3.00 CW = 0.028-0.118			
		f	v _c		
General ISO Turning	P1	CP500	0,022 0.00085	150 490	
		CP500	0,022 0.00085	150 490	
	P2	CP500	0,020 0.00080	130 425	
		CP500	0,020 0.00080	115 375	
Steadyline®	P5	CP500	0,020 0.00080	110 360	
		CP500	0,020 0.00080	120 395	
	P6	CP500	0,020 0.00080	115 375	
		CP500	0,020 0.00080	110 360	
MDT	P11	CP500	0,020 0.00080	110 360	
		CP500	0,014 0.00055	70 230	
	P12	CP500	0,022 0.00085	90 295	
		CP500	0,020 0.00080	65 215	
Mini-Shaft™	M1	CP500	0,016 0.00065	41 135	
		CP500	0,014 0.00055	27 90	
	M2	CP500	0,014 0.00055	22 70	
		CP500	0,022 0.00085	160 520	
	Grooving	K1	CP500	0,020 0.00080	130 425
CP500			0,020 0.00080	110 360	
K2		CP500	0,018 0.00070	65 215	
		CP500	0,020 0.00080	105 345	
Parting-off		K3	CP500	0,018 0.00070	85 280
			CP500	0,028 0.0011	95 310
		K4	CP500	0,014 0.00055	18 60
X4	S1	CP500	0,014 0.00055	15 49	
		CP500	0,013 0.00050	13 43	

Adapters
Clamping units

Accessories and
Spare parts

Workpiece
materials

SGXN – Toolholders for inserts LCEX – Metric

A..SGXN
KAPR = 90,0°

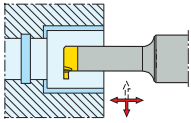

E..SGXN
KAPR = 90,0°

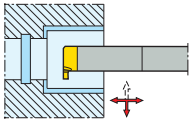

A..SGXN

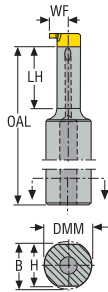

A..SGXN-R

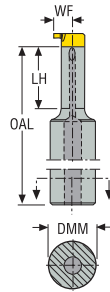

E..SGXN

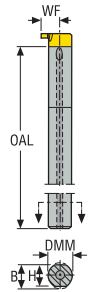

E..SGXN-R

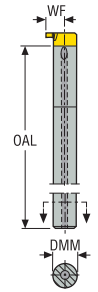

- For inserts program, see page(s) 865-876
- * DCINN – minimum bore diameter, see page(s) 705
- Please check availability at www.secotools.com / Seco Online Store

Designation	Item number	DMM	H	B	OAL	WF	LH	DCINN	Weight	CTWS
		mm	mm	mm	mm	mm	mm	mm	kg	
A12G-SGXN08-20	02411140	12	11,0	11,50	86,5	4,8	16,5	8,0	0,1	LCEX08..
A12G-SGXN08-20-R	02511871	12	–	–	86,5	4,8	16,5	8,0	0,1	LCEX08..
A16H-SGXN11-25	02411142	16	15,0	15,50	96,0	6,7	21,0	11,0	0,2	LCEX11..
A16H-SGXN11-25-R	02511872	16	–	–	96,0	6,7	21,0	11,0	0,2	LCEX11..
E06G-SGXN08	02411141	6	5,5	5,75	86,5	4,8	–	8,0	0,1	LCEX08..
E06G-SGXN08-R	02513692	6	–	–	86,5	4,8	–	8,0	0,1	LCEX08..
E08H-SGXN11	02411143	8	7,3	7,65	96,0	6,7	–	11,0	0,1	LCEX11..
E08H-SGXN11-R	02513696	8	–	–	96,0	6,7	–	11,0	0,1	LCEX11..

Spare Parts

For size	Insert key	Insert screw
A12G..	T08P-2	C02506-T08P
A16H..	T10P-2	C03509-T10P
E06G..	T08P-2	C02506-T08P
E08H..	T10P-2	C03509-T10P

General / ISO Turning

Steadyline®

MDT

Mini-Shaft™

Grooving

Parting-off

X4

Adapters
Clamping units

Accessories and
Spare parts

Workpiece
materials

General ISO Turning

SGXN – Toolholders for inserts LCEX – Inch

Steadyline®

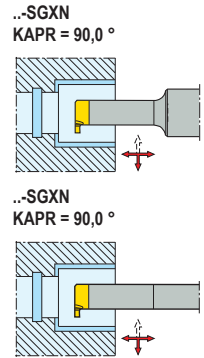
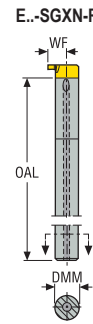
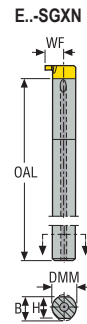
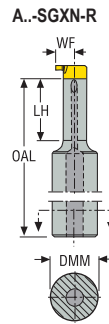
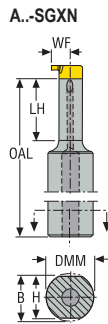

MDT

- For inserts program, see page(s) 865-876
- * DCINN – minimum bore diameter, see page(s) 705
- Please check availability at www.secotools.com / Seco Online Store

Mini-Shaft™

Designation	Item number	DMM	H	B	OAL	WF	LH	DCINN	Weight	CTWS
		Inch	Inch	Inch	Inch	Inch	Inch	Inch	lbs	
A10G-SGXN08-078	02450441	0.625	0.586	0.605	3.406	0.188	0.650	0.315	0.220	LCEX0804..
A10G-SGXN08-078-R	02511873	0.625	–	–	3.406	0.188	0.650	0.315	0.220	LCEX0804..
A10H-SGXN11-098	02450443	0.625	0.586	0.605	3.780	0.264	0.827	0.433	0.440	LCEX1105..
A10H-SGXN11-098-R	02511874	0.625	–	–	3.780	0.264	0.827	0.433	0.440	LCEX1105..
E04G-SGXN08	02450442	0.250	0.217	0.233	3.406	0.189	–	0.315	0.220	LCEX0804..
E04G-SGXN08-R	02513700	0.250	–	–	3.406	0.189	–	0.315	0.220	LCEX0804..
E05H-SGXN11	02450445	0.312	0.287	0.300	3.780	0.264	–	0.433	0.220	LCEX1105..
E05H-SGXN11-R	02513704	0.312	–	–	3.780	0.264	–	0.433	0.220	LCEX1105..

Grooving

Spare Parts

Parting-off

For size	Insert key	Insert screw
A10G-../E04G-..	T08P-2	C02506-T08P
A10H-../E05H-..	T10P-2	C03509-T10P

X4

Adapters
Clamping units

Accessories and
Spare parts

Workpiece
materials

Please check availability at www.secotools.com / Seco Online Store

Tolerances:
CW = $\pm 0,02/0,0008$
WF = $\pm 0,01/0,0004$
LF = $\pm 0,02/0,0008$
RE = $\pm 0,02/0,0008$

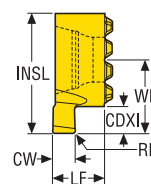

Designation	RE	CW	WF	INSL	CDXI	LF	Grades Coated
	mm Inch	mm Inch	mm Inch	mm Inch	mm Inch	mm Inch	CP500
LCEX080401-0200R	0,1 0,004	2,0 0,079	4,78 0,188	7,78 0,306	1,70 0,067	3,30 0,130	■
LCEX080401-0200L	0,1 0,004	2,0 0,079	4,78 0,188	7,78 0,306	1,70 0,067	3,30 0,130	■
LCEX080402-0150R	0,2 0,008	1,5 0,059	4,78 0,188	7,78 0,306	1,70 0,067	3,30 0,130	■
LCEX080402-0150L	0,2 0,008	1,5 0,059	4,78 0,188	7,78 0,306	1,70 0,067	3,30 0,130	■
LCEX110501-0200R	0,1 0,004	2,0 0,079	6,7 0,264	10,70 0,421	2,60 0,102	4,00 0,157	■
LCEX110501-0200L	0,1 0,004	2,0 0,079	6,7 0,264	10,70 0,421	2,60 0,102	4,00 0,157	■
LCEX110502-0150R	0,2 0,008	1,5 0,059	6,7 0,264	10,70 0,421	2,60 0,102	4,00 0,157	■
LCEX110502-0150L	0,2 0,008	1,5 0,059	6,7 0,264	10,70 0,421	2,60 0,102	4,00 0,157	■

Turning

General / ISO Turning

Steadyline®

MDT

Mini-Shaft™

Grooving

Parting-off

X4

Adapters
Clamping units

Accessories and
Spare parts

Workpiece
materials

General ISO Turning

Steadyline®

MDT

Mini-Shaft™

Grooving

Parting-off

X4

Adapters
Clamping units

Accessories and
Spare parts

Workpiece
materials

Profiling

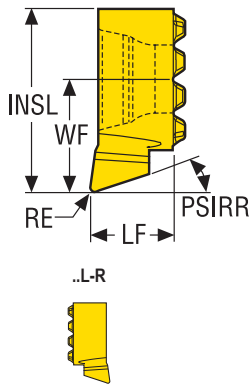

Tolerances:
WF = $\pm 0,01/0,0004$
LF = $\pm 0,02/0,0008$
RE = $\pm 0,02/0,0008$

Please check availability at www.secotools.com / Seco Online Store

Designation	RE	WF	INSL	LF	PSIRR°	PSIRL°	Grades Coated
	mm <i>Inch</i>	mm <i>Inch</i>	mm <i>Inch</i>	mm <i>Inch</i>			CP500
LCEX080402-0250R-L18	0,2 <i>0.008</i>	4,78 <i>0.188</i>	7,78 <i>0.306</i>	3,55 <i>0.140</i>	18,0	0,0	■
LCEX080402-0250L-R18	0,2 <i>0.008</i>	4,78 <i>0.188</i>	7,78 <i>0.306</i>	3,55 <i>0.140</i>	0,0	18,0	■
LCEX080402-0250R-L47	0,2 <i>0.008</i>	4,78 <i>0.188</i>	7,78 <i>0.306</i>	3,45 <i>0.136</i>	47,0	0,0	■
LCEX080402-0250L-R47	0,2 <i>0.008</i>	4,78 <i>0.188</i>	7,78 <i>0.306</i>	3,45 <i>0.136</i>	0,0	47,0	■
LCEX110502-0270R-L18	0,2 <i>0.008</i>	6,7 <i>0.264</i>	10,70 <i>0.421</i>	4,25 <i>0.167</i>	18,0	0,0	■
LCEX110502-0270L-R18	0,2 <i>0.008</i>	6,7 <i>0.264</i>	10,70 <i>0.421</i>	4,25 <i>0.167</i>	0,0	18,0	■
LCEX110502-0250R-L47	0,2 <i>0.008</i>	6,7 <i>0.264</i>	10,70 <i>0.421</i>	4,15 <i>0.163</i>	47,0	0,0	■
LCEX110502-0250L-R47	0,2 <i>0.008</i>	6,7 <i>0.264</i>	10,70 <i>0.421</i>	4,15 <i>0.163</i>	0,0	47,0	■

Please check availability at www.secotools.com / Seco Online Store

Tolerances:
WF = ±0,01/0.0004
LF = ±0,02/0.0008
RE = ±0,02/0.0008

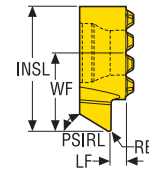

Back facing

..L-L



..R-R



Designation	RE		WF		INSL		LF		PSIRR°		PSIRL°		Grades Coated
	mm	Inch	mm	Inch	mm	Inch	mm	Inch					
LCEX080402-0250R-R30	0,2	0.008	4,78	0.188	7,78	0.306	0,75	0.030	0,0		30,0		CP500
LCEX080402-0250L-L30	0,2	0.008	4,78	0.188	7,78	0.306	0,75	0.030	30,0		0,0		CP500
LCEX110502-0270R-R30	0,2	0.008	6,7	0.264	10,70	0.421	1,25	0.049	0,0		30,0		CP500
LCEX110502-0270L-L30	0,2	0.008	6,7	0.264	10,70	0.421	1,25	0.049	30,0		0,0		CP500

Please check availability at www.secotools.com / Seco Online Store

Tolerances:
WF = ±0,01/0.0004
LF = ±0,05/0.002
RE = ±0,02/0.0008

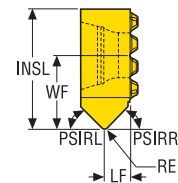

Chamfering

..L



..R



Designation	RE		WF		INSL		LF		PSIRR°		PSIRL°		Grades Coated
	mm	Inch	mm	Inch	mm	Inch	mm	Inch					
LCEX080402-0310R-N45	0,2	0.008	4,78	0.188	7,78	0.306	1,7	0.067	45,0		45,0		CP500
LCEX080402-0310L-N45	0,2	0.008	4,78	0.188	7,78	0.306	1,7	0.067	45,0		45,0		CP500
LCEX110502-0350R-N45	0,2	0.008	6,7	0.264	10,70	0.421	2,2	0.087	45,0		45,0		CP500
LCEX110502-0350L-N45	0,2	0.008	6,7	0.264	10,70	0.421	2,2	0.087	45,0		45,0		CP500

General ISO Turning

Steadyline®

MDT

Mini-Shaft™

Grooving

Parting-off

X4

Adapters Clamping units

Accessories and Spare parts

Workpiece materials

Full radius grooves

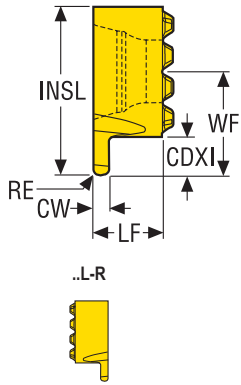

Tolerances:
WF = ±0,01/0.0004
LF = ±0,02/0.0008
RE = ±0,02/0.0008

Please check availability at www.secotools.com / Seco Online Store

Designation	RE	CW	WF	INSL	CDXI	LF	Grades Coated
	mm Inch	mm Inch	mm Inch	mm Inch	mm Inch	mm Inch	CP500
LCEX080404-0080R-R	0,4 0.016	0,8 0.031	4,78 0.188	7,78 0.306	1,70 0.067	3,30 0.130	■
LCEX080404-0080L-R	0,4 0.016	0,8 0.031	4,78 0.188	7,78 0.306	1,70 0.067	3,30 0.130	■
LCEX080406-0120R-R	0,6 0.024	1,2 0.047	4,78 0.188	7,78 0.306	1,70 0.067	3,30 0.130	■
LCEX080406-0120L-R	0,6 0.024	1,2 0.047	4,78 0.188	7,78 0.306	1,70 0.067	3,30 0.130	■
LCEX080409-0180R-R	0,9 0.035	1,8 0.071	4,78 0.188	7,78 0.306	1,70 0.067	3,30 0.130	■
LCEX080409-0180L-R	0,9 0.035	1,8 0.071	4,78 0.188	7,78 0.306	1,70 0.067	3,30 0.130	■
LCEX110504-0080R-R	0,4 0.016	0,8 0.031	6,7 0.264	10,70 0.421	2,60 0.102	4,00 0.157	■
LCEX110504-0080L-R	0,4 0.016	0,8 0.031	6,7 0.264	10,70 0.421	2,60 0.102	4,00 0.157	■
LCEX110506-0120R-R	0,6 0.024	1,2 0.047	6,7 0.264	10,70 0.421	2,60 0.102	4,00 0.157	■
LCEX110506-0120L-R	0,6 0.024	1,2 0.047	6,7 0.264	10,70 0.421	2,60 0.102	4,00 0.157	■
LCEX110509-0180R-R	0,9 0.035	1,8 0.071	6,7 0.264	10,70 0.421	2,60 0.102	4,00 0.157	■
LCEX110509-0180L-R	0,9 0.035	1,8 0.071	6,7 0.264	10,70 0.421	2,60 0.102	4,00 0.157	■
LCEX110510-0200R-R	1,0 0.039	2,0 0.079	6,7 0.264	10,70 0.421	2,60 0.102	4,00 0.157	■
LCEX110510-0200L-R	1,0 0.039	2,0 0.079	6,7 0.264	10,70 0.421	2,60 0.102	4,00 0.157	■
LCEX110515-0300R-R	1,5 0.059	3,0 0.118	6,7 0.264	10,70 0.421	2,60 0.102	4,00 0.157	■
LCEX110515-0300L-R	1,5 0.059	3,0 0.118	6,7 0.264	10,70 0.421	2,60 0.102	4,00 0.157	■

Please check availability at www.secotools.com / Seco Online Store

Tolerances:
CW = ±0,02/0.0008
WF = ±0,01/0.0004
LF = ±0,02/0.0008
RE = ±0,02/0.0008

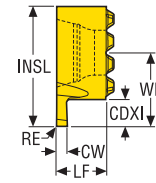

Circlip grooves



Designation	RE	CW	WF	INSL	CDXI	LF	For lock-ring	Grades	
								Coated	CP500
	mm Inch	mm Inch	mm Inch	mm Inch	mm Inch	mm Inch	mm Inch		
LCEX080400-0075R-FG	0	0,75 0.030	4,78 0.188	7,78 0.306	1,70 0.067	3,30 0.130	0,70 0.028	■	
LCEX080400-0075L-FG	0	0,75 0.030	4,78 0.188	7,78 0.306	1,70 0.067	3,30 0.130	0,70 0.028	■	
LCEX080400-0085R-FG	0	0,85 0.033	4,78 0.188	7,78 0.306	1,70 0.067	3,30 0.130	0,80 0.031	■	
LCEX080400-0085L-FG	0	0,85 0.033	4,78 0.188	7,78 0.306	1,70 0.067	3,30 0.130	0,80 0.031	■	
LCEX080400-0095R-FG	0	0,95 0.037	4,78 0.188	7,78 0.306	1,70 0.067	3,30 0.130	0,90 0.035	■	
LCEX080400-0095L-FG	0	0,95 0.037	4,78 0.188	7,78 0.306	1,70 0.067	3,30 0.130	0,90 0.035	■	
LCEX080400-0115R-FG	0	1,15 0.045	4,78 0.188	7,78 0.306	1,70 0.067	3,30 0.130	1,00 0.039	■	
LCEX080400-0115L-FG	0	1,15 0.045	4,78 0.188	7,78 0.306	1,70 0.067	3,30 0.130	1,00 0.039	■	
LCEX080400-0135R-FG	0	1,35 0.053	4,78 0.188	7,78 0.306	1,70 0.067	3,30 0.130	1,20 0.047	■	
LCEX080400-0135L-FG	0	1,35 0.053	4,78 0.188	7,78 0.306	1,70 0.067	3,30 0.130	1,20 0.047	■	
LCEX080401-0165R-FG	0,1 0.004	1,65 0.065	4,78 0.188	7,78 0.306	1,70 0.067	3,30 0.130	1,50 0.059	■	
LCEX080401-0165L-FG	0,1 0.004	1,65 0.065	4,78 0.188	7,78 0.306	1,70 0.067	3,30 0.130	1,50 0.059	■	
LCEX110500-0075R-FG	0	0,75 0.030	6,7 0.264	10,70 0.421	2,60 0.102	4,00 0.157	0,70 0.028	■	
LCEX110500-0075L-FG	0	0,75 0.030	6,7 0.264	10,70 0.421	2,60 0.102	4,00 0.157	0,70 0.028	■	
LCEX110500-0085R-FG	0	0,85 0.033	6,7 0.264	10,70 0.421	2,60 0.102	4,00 0.157	0,80 0.031	■	
LCEX110500-0085L-FG	0	0,85 0.033	6,7 0.264	10,70 0.421	2,60 0.102	4,00 0.157	0,80 0.031	■	
LCEX110500-0095R-FG	0	0,95 0.037	6,7 0.264	10,70 0.421	2,60 0.102	4,00 0.157	0,90 0.035	■	
LCEX110500-0095L-FG	0	0,95 0.037	6,7 0.264	10,70 0.421	2,60 0.102	4,00 0.157	0,90 0.035	■	
LCEX110500-0115R-FG	0	1,15 0.045	6,7 0.264	10,70 0.421	2,60 0.102	4,00 0.157	1,00 0.039	■	
LCEX110500-0115L-FG	0	1,15 0.045	6,7 0.264	10,70 0.421	2,60 0.102	4,00 0.157	1,00 0.039	■	
LCEX110500-0135R-FG	0	1,35 0.053	6,7 0.264	10,70 0.421	2,60 0.102	4,00 0.157	1,20 0.047	■	
LCEX110500-0135L-FG	0	1,35 0.053	6,7 0.264	10,70 0.421	2,60 0.102	4,00 0.157	1,20 0.047	■	

General ISO Turning

Steadyline®

MDT

Mini-Shaft™

Grooving

Parting-off

X4

Adapters
Clamping units

Accessories and
Spare parts

Workpiece
materials

General ISO Turning	Designation	RE	CW	WF	INSL	CDXI	LF	For lock-ring	Grades
		mm <i>Inch</i>	mm <i>Inch</i>	mm <i>Inch</i>	mm <i>Inch</i>	mm <i>Inch</i>	mm <i>Inch</i>	mm <i>Inch</i>	Coated
									CF500
	LCEX110501-0165R-FG	0,1 0.004	1,65 0.065	6,7 0.264	10,70 0.421	2,60 0.102	4,00 0.157	1,50 0.059	■
	LCEX110501-0165L-FG	0,1 0.004	1,65 0.065	6,7 0.264	10,70 0.421	2,60 0.102	4,00 0.157	1,50 0.059	■

Steadyline®

MDT

Mini-Shaft™

Grooving

Parting-off

X4

Adapters
Clamping units

Accessories and
Spare parts

Workpiece
materials

Please check availability at www.secotools.com / Seco Online Store

Tolerances:
WF = ±0,01/0.0004
LF = ±0,05/0.002

Threading – Partial profile 60°

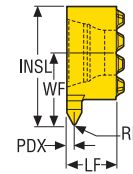

Designation	RE	WF	INSL	LF	PDX	Pitch	Pitch	Grades Coated
	mm Inch	mm Inch	mm Inch	mm Inch	mm Inch	mm	TPI	CP500
LCEX0804-A60R	0,03 0.001	4,78 0.188	7,78 0.306	3,30 0.130	0,48 0.019	0,5-0,75	36-48	■
LCEX0804-A60L	0,03 0.001	4,78 0.188	7,78 0.306	3,30 0.130	0,48 0.019	0,5-0,75	36-48	■
LCEX0804-AG60R	0,07 0.003	4,78 0.188	7,78 0.306	3,30 0.130	0,73 0.029	0,75-1,25	20-36	■
LCEX0804-AG60L	0,07 0.003	4,78 0.188	7,78 0.306	3,30 0.130	0,73 0.029	0,75-1,25	20-36	■
LCEX0804-G60R	0,12 0.005	4,78 0.188	7,78 0.306	3,30 0.130	0,98 0.039	1,25-1,75	16-20	■
LCEX0804-G60L	0,12 0.005	4,78 0.188	7,78 0.306	3,30 0.130	0,98 0.039	1,25-1,75	16-20	■
LCEX1105-A60R	0,03 0.001	6,7 0.264	10,70 0.421	4,00 0.157	0,48 0.019	0,5-0,75	36-48	■
LCEX1105-A60L	0,03 0.001	6,7 0.264	10,70 0.421	4,00 0.157	0,48 0.019	0,5-0,75	36-48	■
LCEX1105-AG60R	0,07 0.003	6,7 0.264	10,70 0.421	4,00 0.157	0,73 0.029	0,75-1,25	20-36	■
LCEX1105-AG60L	0,07 0.003	6,7 0.264	10,70 0.421	4,00 0.157	0,73 0.029	0,75-1,25	20-36	■
LCEX1105-G60R	0,12 0.005	6,7 0.264	10,70 0.421	4,00 0.157	0,98 0.039	1,25-1,75	20-16	■
LCEX1105-G60L	0,12 0.005	6,7 0.264	10,70 0.421	4,00 0.157	0,98 0.039	1,25-1,75	16-20	■

General ISO Turning

Steadyline®

MDT

Mini-Shaft™

Grooving

Parting-off

X4

Adapters
Clamping units

Accessories and
Spare parts

Workpiece
materials

Threading – ISO Metric

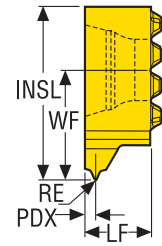

Tolerances:
WF = $\pm 0,01/0,0004$
LF = $\pm 0,05/0,002$

Please check availability at www.secotools.com / Seco Online Store

..L



..R



Designation	RE	WF	INSL	LF	PDX	Pitch	Pitch	Grades Coated
	mm Inch	mm Inch	mm Inch	mm Inch	mm Inch	mm	TPI	CP500
LCEX1105-1.0ISOR	0,07 0.003	6,7 0.264	10,70 0.421	4,00 0.157	0,60 0.024	1,0	-	■
LCEX1105-1.0ISOL	0,07 0.003	6,7 0.264	10,70 0.421	4,00 0.157	0,60 0.024	1,0	-	■
LCEX1105-1.5ISOR	0,12 0.005	6,7 0.264	10,70 0.421	4,00 0.157	0,85 0.033	1,5	-	■
LCEX1105-1.5ISOL	0,12 0.005	6,7 0.264	10,70 0.421	4,00 0.157	0,80 0.031	1,5	-	■
LCEX1105-2.0ISOR	0,17 0.007	6,7 0.264	10,70 0.421	4,00 0.157	1,10 0.043	2,0	-	■
LCEX1105-2.0ISOL	0,17 0.007	6,7 0.264	10,70 0.421	4,00 0.157	1,10 0.043	2,0	-	■
LCEX1105-2.5ISOR	0,18 0.007	6,7 0.264	10,70 0.421	4,00 0.157	1,35 0.053	2,5	-	■
LCEX1105-2.5ISOL	0,18 0.007	6,7 0.264	10,70 0.421	4,00 0.157	1,35 0.053	2,5	-	■
LCEX1105-3.0ISOR	0,21 0.008	6,7 0.264	10,70 0.421	4,00 0.157	1,60 0.063	3,0	-	■
LCEX1105-3.0ISOL	0,21 0.008	6,7 0.264	10,70 0.421	4,00 0.157	1,60 0.063	3,0	-	■

Please check availability at www.secotools.com / Seco Online Store

Tolerances:
WF = $\pm 0,01/0.0004$
LF = $\pm 0,05/0.002$

Threading – Whitworth, BSW

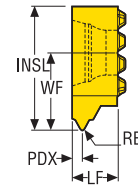

Designation	RE	WF	INSL	LF	PDX	Pitch	Pitch	Grades Coated
	mm Inch	mm Inch	mm Inch	mm Inch	mm Inch	mm	TPI	CP500
LCEX1105-14WR	0,24 0.009	6,7 0.264	10,70 0.421	4,00 0.157	1,00 0.039	-	14	■
LCEX1105-14WL	0,24 0.009	6,7 0.264	10,70 0.421	4,00 0.157	1,00 0.039	-	14	■
LCEX1105-19WR	0,15 0.006	6,7 0.264	10,70 0.421	4,00 0.157	0,77 0.030	-	19	■
LCEX1105-19WL	0,15 0.006	6,7 0.264	10,70 0.421	4,00 0.157	0,77 0.030	-	19	■

- General ISO Turning
- Steadyline®
- MDT
- Mini-Shaft™
- Grooving
- Parting-off
- X4
- Adapters Clamping units
- Accessories and Spare parts
- Workpiece materials

Threading – TR-DIN103

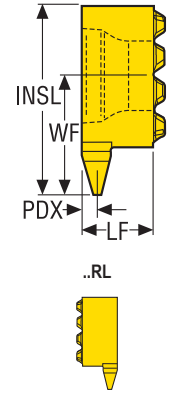

Tolerances:
WF = $\pm 0,01/0,0004$
LF = $\pm 0,05/0,002$

Please check availability at www.secotools.com / Seco Online Store

Designation	RE	WF	INSL	LF	PDX	Pitch	Pitch	Grades Coated
	mm Inch	mm Inch	mm Inch	mm Inch	mm Inch	mm	TPI	CP500
LCEX1105-1.5TRR	0,1 0.004	6,7 0.264	10,70 0.421	4,00 0.157	0,80 0.031	1,5	–	■
LCEX1105-1.5TRL	0,1 0.004	6,7 0.264	10,70 0.421	4,00 0.157	0,80 0.031	1,5	–	■
LCEX1105-2.0TRR	0,15 0.006	6,7 0.264	10,70 0.421	4,00 0.157	1,10 0.043	2,0	–	■
LCEX1105-2.0TRL	0,15 0.006	6,7 0.264	10,70 0.421	4,00 0.157	1,10 0.043	2,0	–	■
LCEX1105-3.0TRR	0,15 0.006	6,7 0.264	10,70 0.421	4,00 0.157	1,60 0.063	3,0	–	■
LCEX1105-3.0TRL	0,15 0.006	6,7 0.264	10,70 0.421	4,00 0.157	1,60 0.063	3,0	–	■

General ISO Turning

Steadyline®

MDT

Mini-Shaft™

Grooving

Parting-off

X4

Adapters
Clamping units

Accessories and
Spare parts

Workpiece
materials

Please check availability at www.secotools.com / Seco Online Store

Tolerances:
WF = $\pm 0,01/0.0004$
LF = $\pm 0,05/0.002$

Threading – UN

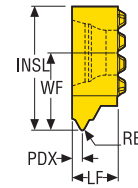

Designation	RE	WF	INSL	LF	PDX	Pitch	Pitch	Grades Coated
	mm Inch	mm Inch	mm Inch	mm Inch	mm Inch	mm	TPI	CP500
LCEX0804-32UNR	0,04 0.002	4,78 0.188	7,78 0.306	3,30 0.130	0,50 0.020	-	32	■
LCEX0804-32UNL	0,04 0.002	4,78 0.188	7,78 0.306	3,30 0.130	0,50 0.020	-	32	■
LCEX0804-24UNR	0,07 0.003	4,78 0.188	7,78 0.306	3,30 0.130	0,60 0.024	-	24	■
LCEX0804-24UNL	0,07 0.003	4,78 0.188	7,78 0.306	3,30 0.130	0,60 0.024	-	24	■
LCEX0804-20UNR	0,09 0.004	4,78 0.188	7,78 0.306	3,30 0.130	0,70 0.028	-	20	■
LCEX0804-20UNL	0,09 0.004	4,78 0.188	7,78 0.306	3,30 0.130	0,70 0.028	-	20	■
LCEX0804-16UNR	0,13 0.005	4,78 0.188	7,78 0.306	3,30 0.130	0,90 0.035	-	16	■
LCEX0804-16UNL	0,13 0.005	4,78 0.188	7,78 0.306	3,30 0.130	0,90 0.035	-	16	■

General ISO Turning

Steadyline®

MDT

Mini-Shaft™

Grooving

Parting-off

X4

Adapters
Clamping units

Accessories and
Spare parts

Workpiece
materials

General ISO Turning

Threading – NPT

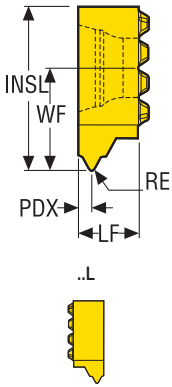

Tolerances:
WF = $\pm 0,01/0,0004$
LF = $\pm 0,05/0,002$

Please check availability at www.secotools.com / Seco Online Store

Steadyline®

MDT

Designation	RE	WF	INSL	LF	PDX	Pitch	Pitch	Grades Coated
	mm <i>Inch</i>	mm <i>Inch</i>	mm <i>Inch</i>	mm <i>Inch</i>	mm <i>Inch</i>	mm	TPI	CP500
LCEX0804-27NPTR	0,03 <i>0.001</i>	4,78 <i>0.188</i>	7,78 <i>0.306</i>	3,30 <i>0.130</i>	0,57 <i>0.022</i>	–	27	■
LCEX0804-27NPTL	0,03 <i>0.001</i>	4,78 <i>0.188</i>	7,78 <i>0.306</i>	3,30 <i>0.130</i>	0,57 <i>0.022</i>	–	27	■

Mini-Shaft™

Grooving

Threading – NPTF

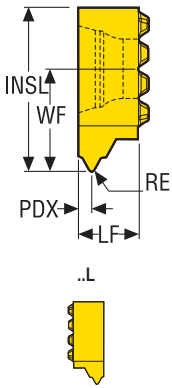

Tolerances:
WF = $\pm 0,01/0,0004$
LF = $\pm 0,05/0,002$

Please check availability at www.secotools.com / Seco Online Store

Parting-off

X4

Designation	RE	WF	INSL	LF	PDX	Pitch	Pitch	Grades Coated
	mm <i>Inch</i>	mm <i>Inch</i>	mm <i>Inch</i>	mm <i>Inch</i>	mm <i>Inch</i>	mm	TPI	CP500
LCEX0804-27NPTFR	0,04 <i>0.002</i>	4,78 <i>0.188</i>	7,78 <i>0.306</i>	3,30 <i>0.130</i>	0,57 <i>0.022</i>	–	27	■
LCEX0804-27NPTFL	0,04 <i>0.002</i>	4,78 <i>0.188</i>	7,78 <i>0.306</i>	3,30 <i>0.130</i>	0,57 <i>0.022</i>	–	27	■

Adapters Clamping units

Accessories and Spare parts

Workpiece materials



Grooving

The Seco K-Style system is intended for radial and axial as well as external and internal precision grooving. The range of grooving inserts includes inserts for most groove profiles, such as circlip profiles, O-ring profiles, thread undercut and radius grooves.

- All toolholders are used for both R and L-handed inserts
- Radial external, radial internal and axial grooving.
- Toolholders have replaceable shims designed to protect the insert seat.

Toolholders

General ISO Turning

Steadyline®

MDT

Mini-Shaft™

Grooving

Parting-off

X4

Adapters
Clamping units

Accessories and
Spare parts

Workpiece
materials

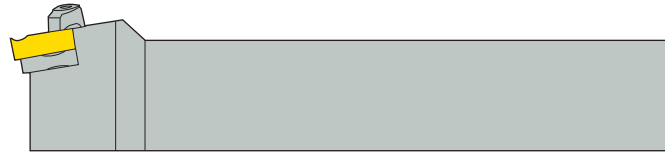



C	E	R	25	25	M	14	Q	HD
1	2	3	4	5	6	7	8	9

1. Insert clamping	2. External/Internal	3. Version	
<p>C Clamp</p>	<p>E = External N = Internal EA = External axial</p>	<p>R</p>	<p>L</p>
4. Shank height	5. Shank width/diameter	6. Tool length	
<p>H</p> <p>12 = 12 mm 16 = 16 mm 20 = 20 mm etc.</p>	<p>B DMM</p> <p>12 = 12 mm 16 = 16 mm 20 = 20 mm etc.</p>	<p>LF</p> <p>H = 100 mm K = 125 mm M = 150 mm P = 170 mm R = 200 mm</p>	<p>H = 100 mm K = 125 mm M = 150 mm P = 170 mm R = 200 mm</p>
7. Cutting edge length	8. Other information	9. Internal designation	
<p>IGL</p> <p>If the cutting edge length consists of only one digit, the designation should start with a 0.</p> <p>Example: Cutting edge length = 9,525 mm Symbol = 09</p>	<p>A = Steel with coolant passage D = Holder for deep grooving Q = Toolholder/cranked</p>	<p>HD = Heavy Duty</p>	

Inserts

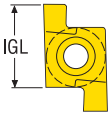

14	E	R	3.4	FG
1	2	3	4	5

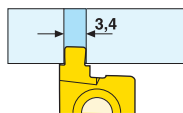
1. Cutting edge length	2. External/Internal	3. Version
 <p>If the cutting edge length consists of only one digit, the designation should start with a 0.</p> <p>Example: Cutting edge length = 9,525 mm Symbol = 09</p>	<p>E = External N = Internal EA = External axial</p>	<div style="display: flex; justify-content: space-around;"> <div style="text-align: center;"> <p>R</p>  </div> <div style="text-align: center;"> <p>L</p>  </div> </div>
4. Groove width	5. Standard grooves	
 <p>Example: 3.4 = 3,4 mm</p>	<p>FG = For radial grooves (CW x 1) FD = For radial deep grooves (CW x 2) D76 = For thread undercuts R = For radius ST = For static O-rings DY = For dynamic O-rings AX = For axial O-rings FA = For axial grooves (CW x 1)</p>	

General ISO Turning

Steadyline®

MDT

Mini-Shaft™

Grooving

Parting-off

X4

Adapters
Clamping units

Accessories and
Spare parts

Workpiece
materials

Grooving – Precision grooves, depth/width ratio 1:1 (2:1)

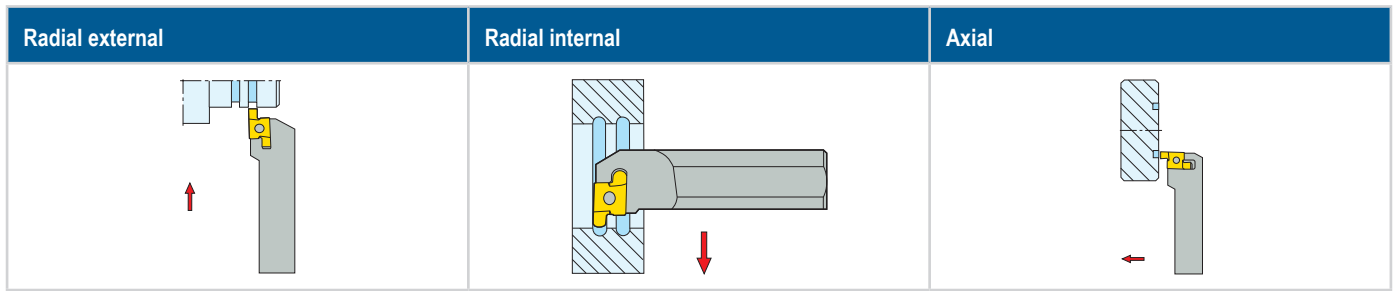

Toolholders	
<p>The toolholder system is based on the Snap Tap threading system. The toolholders have replaceable shims designed to protect the insert seat.</p> <p>The system is intended for radial external and internal grooving and for axial grooving. The system enables axial grooves from 16 mm outside diameter and internal radial grooves down to 13 mm diameter to be turned.</p>	

Inserts		
<ul style="list-style-type: none"> – Machine the face down to the end point of the radius or chamfer. – Make a groove to the required depth at the end point of the radius or chamfer. – Machine down to the end point of the radius or chamfer. – Machine the radius or chamfer. – Machine the diameter until the end point of the radius or chamfer is reached (remember to compensate for the deflection). – Machine the radius or chamfer. 	<p>Locking</p>	<p>O-ring</p>
	<p>Thread undercut</p>	<p>Radius</p>

Indicative ISO classification of the grades

Steel P
Stainless steel M
Cast iron K
Non-ferrous metals N
Superalloys and titanium S
Hard materials H

	P					M					K					N					S					H				
	P01	P10	P20	P30	P40	P50	M01	M10	M20	M30	M40	K01	K10	K20	K30	K40	N01	N10	N20	N30	S01	S10	S20	S30	H01	H10	H20	H30	H40	
CP30																														
CP500																														

CP30
Wear resistant CVD-coated grade intended for grooving in a variety of workpiece materials. Provides good wear resistance and cutting speed capability in steel and cast iron.

CP500
Tough versatile PVD-coated micrograin grade intended for grooving in a variety of workpiece materials. Universal choice.

Ordering specification for custom made K-inserts

Ordering specification for custom made K-inserts

Internal grooving:

When considering operation NR and NL illustrated above (holder CNR and CNL), always state the diameter of the hole as well as the axial position of the groove = LH. In the case of small hole diameters, however, use holder SNR and SNL with insert 9NR and 9NL respectively.

Axial grooving:

With operation type EAR and EAL (holder CEAR and CEAL) the outer dimension of the groove (INPLM) must be stated.

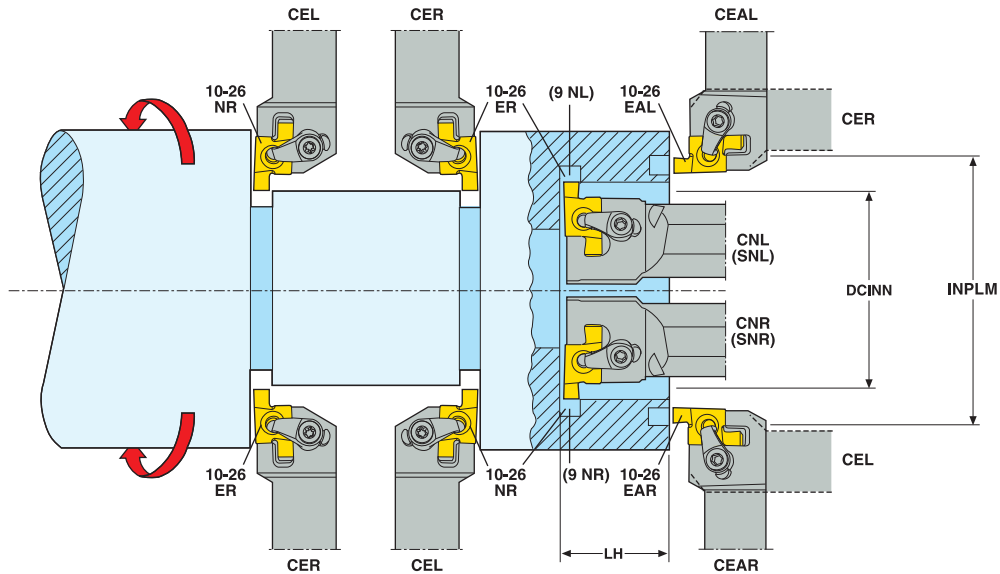

Set-up machining recommendations

Set-up

- The mounting should be stable.
- The tool should be securely clamped and the overhang should be as small as possible.
- The centre height should never deviate by more than $\pm 0,1$ mm from the workpiece centre.

Internal grooving

- Decisive factors for ensuring vibration-free machining are the relationship between the toolholder overhang and its diameter, and the width of the grooving insert.
- In unfavourable circumstances, the cutting speed and feed rate should be reduced below the recommended values

Grooving of radius grooves and grooves with trapezoidal cross-section

In this type of grooving, different forms of chip problems often occur. The feed rate should therefore be reduced to obtain thin chips and avoid chip build-up and insert fracture.

Formulae for cutting data calculation are found in page(s) 102.

Special inserts for precision grooves

- Ground to specification using the insert blanks shown.
- Blanks available for grade CP30 and CP500.
- Please contact your local representative for price and delivery.

Tolerances for different groove profiles:

CDXI	CW	RE
$\pm 0,025$	$\pm 0,025$	$\pm 0,03$

Inserts	Dimensions				Shim Standard KX	Inserts	
	IGL	W1	CW	CDXI			
	9,0	6,350	2,7	2,70	–	9NR/NL	
		9,0	6,350	2,7	2,70	KX10	10ER/NR 10EAR/EAL
		12,0	6,350	2,7	5,65	KX12	12ER/NR 12EAR/EAL
		14,0	9,525	4,2	4,40	KX14	14ER/NR 14EAR/EAL
		20,0	12,700	6,3	7,30	KX20	20ER/NR 20EAR/EAL
		26,0	15,875	10,0	10,10	KX26	26ER/NR 26EAR/EAL

Cutting speed, v_c (m/min)

In this section a recommended cutting speed is indicated under specified conditions.
Use the tables beginning on page(s) 1006 to classify the workpiece material into a SMG
The cutting data tables provide a start value for feed rate (f) and cutting speed (v_c) for the selected cutting width (CW).
The cutting data tables are based on grooving with full cutting width.
The recommended cutting speeds in the tables are calculated for 15 minutes tool life with use of external flood coolant.
In order to increase the accuracy towards the actual cutting conditions and requirements of the applications the recommendation is to use My Pages – Suggest on www.secotools.com

v_c = cutting speed (m/min)

CW = cutting width (mm)

f = feed rate (mm/rev)

Grade CP30

SMG		CW = 0.5-2.0 CW = 0.020-0.079		CW = 2.0-4.0 CW = 0.079-0.157		CW = 4.0-6.0 CW = 0.157-0.236		CW = 6.0-8.0 CW = 0.236-0.315		CW = 8.0-10.0 CW = 0.315-0.394	
		f	v_c	f	v_c	f	v_c	f	v_c	f	v_c
P1	CP30	0,095	195	0,15	165	0,17	160	0,20	150	0,22	140
		0.0038	640	0.0060	540	0.0065	520	0.0080	490	0.0085	460
P2	CP30	0,10	190	0,16	160	0,17	155	0,20	145	0,22	140
		0.0040	620	0.0065	520	0.0065	510	0.0080	475	0.0085	460
P3	CP30	0,095	165	0,15	140	0,17	135	0,19	125	0,20	125
		0.0038	540	0.0060	460	0.0065	445	0.0075	410	0.0080	410
P4	CP30	0,090	145	0,14	125	0,16	120	0,19	110	0,20	110
		0.0036	475	0.0055	410	0.0065	395	0.0075	360	0.0080	360
P5	CP30	0,090	140	0,14	120	0,16	115	0,18	110	0,20	105
		0.0036	460	0.0055	395	0.0065	375	0.0070	360	0.0080	345
P6	CP30	0,090	160	0,14	135	0,16	130	0,18	120	0,20	115
		0.0036	520	0.0055	445	0.0065	425	0.0070	395	0.0080	375
P7	CP30	0,090	150	0,14	125	0,16	120	0,18	115	0,20	110
		0.0036	490	0.0055	410	0.0065	395	0.0070	375	0.0080	360
P8	CP30	0,095	140	0,15	115	0,17	110	0,19	105	0,20	105
		0.0038	460	0.0060	375	0.0065	360	0.0075	345	0.0080	345
P11	CP30	0,090	145	0,14	125	0,16	115	0,18	110	0,20	105
		0.0036	475	0.0055	410	0.0065	375	0.0070	360	0.0080	345
P12	CP30	0,060	95	0,095	85	0,11	80	0,12	75	0,14	70
		0.0024	310	0.0038	280	0.0044	260	0.0048	245	0.0055	230
M1	CP30	0,10	220	0,16	165	0,17	155	0,20	135	0,22	120
		0.0040	720	0.0065	540	0.0065	510	0.0080	445	0.0085	395
M2	CP30	0,090	185	0,14	145	0,16	130	0,18	120	0,20	105
		0.0036	610	0.0055	475	0.0065	425	0.0070	395	0.0080	345
M3	CP30	0,070	150	0,11	130	0,13	115	0,15	105	0,16	100
		0.0028	490	0.0044	425	0.0050	375	0.0060	345	0.0065	330
M4	CP30	0,065	115	0,10	100	0,11	95	0,13	85	0,14	80
		0.0026	375	0.0040	330	0.0044	310	0.0050	280	0.0055	260
M5	CP30	0,065	95	0,10	85	0,11	80	0,13	70	0,14	70
		0.0026	310	0.0040	280	0.0044	260	0.0050	230	0.0055	230

Grade CP500

SMG		CW = 0.5-2.0 <i>CW = 0.020-0.079</i>		CW = 2.0-4.0 <i>CW = 0.079-0.157</i>		CW = 4.0-6.0 <i>CW = 0.157-0.236</i>		CW = 6.0-8.0 <i>CW = 0.236-0.315</i>		CW = 8.0-10.0 <i>CW = 0.315-0.394</i>	
		f	v _c	f	v _c	f	v _c	f	v _c	f	v _c
P1	CP500	0,095	150	0,15	125	0,17	120	0,20	115	0,22	110
		<i>0.0038</i>	490	<i>0.0060</i>	410	<i>0.0065</i>	395	<i>0.0080</i>	375	<i>0.0085</i>	360
P2	CP500	0,10	145	0,16	120	0,17	120	0,20	110	0,22	105
		<i>0.0040</i>	475	<i>0.0065</i>	395	<i>0.0065</i>	395	<i>0.0080</i>	360	<i>0.0085</i>	345
P3	CP500	0,095	125	0,15	105	0,17	100	0,19	95	0,20	95
		<i>0.0038</i>	410	<i>0.0060</i>	345	<i>0.0065</i>	330	<i>0.0075</i>	310	<i>0.0080</i>	310
P4	CP500	0,090	115	0,14	95	0,16	90	0,19	85	0,20	85
		<i>0.0036</i>	375	<i>0.0055</i>	310	<i>0.0065</i>	295	<i>0.0075</i>	280	<i>0.0080</i>	280
P5	CP500	0,090	105	0,14	90	0,16	85	0,18	85	0,20	80
		<i>0.0036</i>	345	<i>0.0055</i>	295	<i>0.0065</i>	280	<i>0.0070</i>	280	<i>0.0080</i>	260
P6	CP500	0,090	120	0,14	105	0,16	100	0,18	95	0,20	90
		<i>0.0036</i>	395	<i>0.0055</i>	345	<i>0.0065</i>	330	<i>0.0070</i>	310	<i>0.0080</i>	295
P7	CP500	0,090	115	0,14	95	0,16	90	0,18	90	0,20	85
		<i>0.0036</i>	375	<i>0.0055</i>	310	<i>0.0065</i>	295	<i>0.0070</i>	295	<i>0.0080</i>	280
P8	CP500	0,095	105	0,15	90	0,17	85	0,19	80	0,20	80
		<i>0.0038</i>	345	<i>0.0060</i>	295	<i>0.0065</i>	280	<i>0.0075</i>	260	<i>0.0080</i>	260
P11	CP500	0,090	110	0,14	95	0,16	90	0,18	85	0,20	80
		<i>0.0036</i>	360	<i>0.0055</i>	310	<i>0.0065</i>	295	<i>0.0070</i>	280	<i>0.0080</i>	260
P12	CP500	0,060	75	0,095	65	0,11	60	0,12	60	0,14	55
		<i>0.0024</i>	245	<i>0.0038</i>	215	<i>0.0044</i>	195	<i>0.0048</i>	195	<i>0.0055</i>	180
M1	CP500	0,10	170	0,16	125	0,17	120	0,20	100	0,22	95
		<i>0.0040</i>	560	<i>0.0065</i>	410	<i>0.0065</i>	395	<i>0.0080</i>	330	<i>0.0085</i>	310
M2	CP500	0,090	140	0,14	110	0,16	100	0,18	90	0,20	80
		<i>0.0036</i>	460	<i>0.0055</i>	360	<i>0.0065</i>	330	<i>0.0070</i>	295	<i>0.0080</i>	260
M3	CP500	0,070	115	0,11	100	0,13	90	0,15	80	0,16	75
		<i>0.0028</i>	375	<i>0.0044</i>	330	<i>0.0050</i>	295	<i>0.0060</i>	260	<i>0.0065</i>	245
M4	CP500	0,065	85	0,10	75	0,11	75	0,13	65	0,14	65
		<i>0.0026</i>	280	<i>0.0040</i>	245	<i>0.0044</i>	245	<i>0.0050</i>	215	<i>0.0055</i>	215
M5	CP500	0,065	70	0,10	65	0,11	60	0,13	55	0,14	50
		<i>0.0026</i>	230	<i>0.0040</i>	215	<i>0.0044</i>	195	<i>0.0050</i>	180	<i>0.0055</i>	165
K1	CP500	0,10	130	0,16	110	0,17	105	0,20	100	0,22	95
		<i>0.0040</i>	425	<i>0.0065</i>	360	<i>0.0065</i>	345	<i>0.0080</i>	330	<i>0.0085</i>	310
K2	CP500	0,090	115	0,14	95	0,16	90	0,18	85	0,20	80
		<i>0.0036</i>	375	<i>0.0055</i>	310	<i>0.0065</i>	295	<i>0.0070</i>	280	<i>0.0080</i>	260
K3	CP500	0,090	100	0,14	80	0,16	75	0,18	70	0,20	65
		<i>0.0036</i>	330	<i>0.0055</i>	260	<i>0.0065</i>	245	<i>0.0070</i>	230	<i>0.0080</i>	215
K4	CP500	0,090	95	0,14	75	0,16	70	0,18	65	0,20	65
		<i>0.0036</i>	310	<i>0.0055</i>	245	<i>0.0065</i>	230	<i>0.0070</i>	215	<i>0.0080</i>	215
K5	CP500	0,080	60	0,13	47	0,14	45	0,16	42	0,18	40
		<i>0.0032</i>	195	<i>0.0050</i>	155	<i>0.0055</i>	150	<i>0.0065</i>	140	<i>0.0070</i>	130
K6	CP500	0,090	85	0,14	70	0,16	65	0,18	65	0,20	60
		<i>0.0036</i>	280	<i>0.0055</i>	230	<i>0.0065</i>	215	<i>0.0070</i>	215	<i>0.0080</i>	195
K7	CP500	0,080	75	0,13	60	0,14	60	0,16	55	0,18	50
		<i>0.0032</i>	245	<i>0.0050</i>	195	<i>0.0055</i>	195	<i>0.0065</i>	180	<i>0.0070</i>	165
N11	CP500	0,13	90	0,20	75	0,22	70	0,26	65	0,28	65
		<i>0.0050</i>	295	<i>0.0080</i>	245	<i>0.0085</i>	230	<i>0.010</i>	215	<i>0.011</i>	215
S1	CP500	0,065	18	0,10	16	0,11	15	0,13	15	0,14	14
		<i>0.0026</i>	60	<i>0.0040</i>	50	<i>0.0044</i>	49	<i>0.0050</i>	49	<i>0.0055</i>	46
S2	CP500	0,065	16	0,10	14	0,11	13	0,13	13	0,14	12
		<i>0.0026</i>	50	<i>0.0040</i>	46	<i>0.0044</i>	43	<i>0.0050</i>	43	<i>0.0055</i>	39
S3	CP500	0,060	14	0,090	12	0,10	12	0,12	11	0,13	11
		<i>0.0024</i>	46	<i>0.0036</i>	39	<i>0.0040</i>	39	<i>0.0048</i>	36	<i>0.0050</i>	36

General ISO Turning

Steadyline®

MDT

Mini-Shaft™

Grooving

Parting-off

X4

Adapters
Clamping units

Accessories and
Spare parts

Workpiece
materials

C.-CEL – Toolholders for Shallow Grooves – Metric / Inch

C.-CEL
KAPR = 90,0°

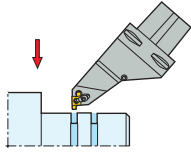

C.-CEL-HD
KAPR = 90,0°

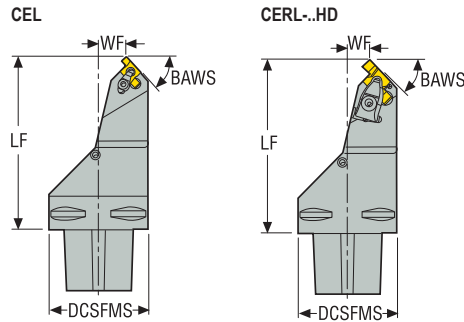
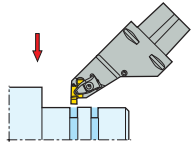

- For inserts program, see page(s) 900, 902-904, 905
- CTMS = Seco-Capto™ size
- CTWS = Insert shape and size
- * Shim KX12-2 for insert 12..
- Left-hand version shown
- Please check availability at www.secotools.com / Seco Online Store

Designation	Item number	CTMS	DCSFMS		LF	Weight	BAWS°	CTWS				
			mm	Inch								
C6-CEL-20110-10	02509305	C6	63,0	2,480	20,0	0,787	110	4,331	1,6	3,530	45,0	10/12NR
C6-CEL-18110-14	02509306	C6	63,0	2,480	18,0	0,709	110	4,331	1,7	3,750	45,0	14NR
C6-CEL-14110-20HD	02509308	C6	63,0	2,480	14,0	0,551	110	4,331	1,7	3,750	45,0	20
C6-CEL-07110-26HD	02509309	C6	63,0	2,480	7,0	0,276	110	4,331	1,7	3,750	45,0	26

Spare Parts

For size	Cantilever clamp	Clamp key	Clamp kit	Clamp screw	Coolant nozzle	Insert shim (K)	Shim screw	Spring
-10	-	T15P-2	CSP16-T15P	-	CN8	KX10-2	CS2507-T07P	-
-14	-	T15P-2	CSP16-T15P	-	CN8	KX14-2	CS3507-T09P	-
-20	CHD22	T20P-7	-	L86025-T20P	CN8	KX20-2	CS4009-T15P	S7616
-26	CHD27	T20P-7	-	L86025-T20P	CN8	KX26-2	C05012-T15P	S7616

Accessories

For size	Insert shim (K) 1	Insert shim (K) 2	Insert shim (K) 3	Insert shim (K) 4	Insert shim (K) 5	Insert shim (K) 6	Insert shim (K) 7	Shim key
-10	KX12-2	KX10-99	KX10-0	KX10-1	KX10-3	KX10-4	KX10-5	T07P-2
-14	KX14-0	KX14-1	KX14-3	KX14-4	KX14-5	-	-	T09P-2
-20	KX20-99	KX20-0	KX20-1	KX20-3	KX20-4	KX20-5	-	T15P-2
-26	KX26-99	KX26-0	KX26-1	KX26-3	KX26-4	KX26-5	-	T15P-2

General / ISO Turning

Steadyline®

MDT

Mini-Shaft™

Grooving

Parting-off

X4

Adapters
Clamping units

Accessories and
Spare parts

Workpiece
materials

CER/L. – Toolholders for Precision Grooves – Metric

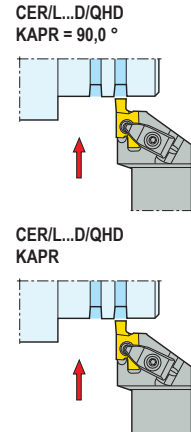
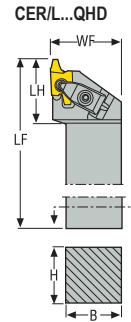
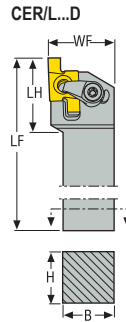

- For inserts program, see page(s) 900, 902-904, 905
- CTWS = Insert shape and size
- * Shim KX12-2 for insert 12..
- Right-hand version shown
- Please check availability at www.secotools.com / Seco Online Store

Designation	Item number	H	B	LF 10/14/20/26	LF2 12	WF	LH 10/14/20/26	LH2 12	Weight	CTWS
		mm	mm	mm	mm	mm	mm	mm	kg	
CER1212M10D	02435850	12	12	150	153,0	16	21,5	24,5	0,2	10/12ER
CER1616H10D	02411427	16	16	100	103,0	16	21,5	24,5	0,2	10/12ER
CER2020K10D	02411428	20	20	125	128,0	25	21,5	24,5	0,4	10/12ER
CER2525M10D	02411430	25	25	150	153,0	32	21,5	24,5	0,8	10/12ER
CER3225P10D	02411432	32	25	170	173,0	32	22,5	25,5	1,1	10/12ER
CEL1212M10D	02435852	12	12	150	153,0	16	21,5	24,5	0,2	10/12NR
CEL1616H10D	02411436	16	16	100	103,0	16	21,5	24,5	0,2	10/12NR
CEL2020K10D	02411437	20	20	125	128,0	25	21,5	24,5	0,4	10/12NR
CEL2525M10D	02411438	25	25	150	153,0	32	21,5	24,5	0,8	10/12NR
CEL3225P10D	02411440	32	25	170	173,0	32	22,5	25,5	1,1	10/12NR
CER2525M14QHD	02538606	25	25	150	–	32	26,0	–	0,8	14ER
CER3225P14QHD	02627519	32	25	170	–	32	26,0	–	1,1	14ER
CER3232P14QHD	02627520	32	32	170	–	32	26,0	–	1,4	14ER
CEL2525M14QHD	02627518	25	25	150	–	32	26,0	–	0,8	14NR
CER2525M20QHD	02528502	25	25	150	–	32	34,0	–	0,8	20ER
CER3225P20QHD	02528504	32	25	170	–	32	34,0	–	1,1	20ER
CER3232P20QHD	02528507	32	32	170	–	40	34,0	–	1,4	20ER
CEL2525M20QHD	02528503	25	25	150	–	32	34,0	–	0,8	20NR
CEL3225P20QHD	02528505	32	25	170	–	32	34,0	–	1,1	20NR
CEL3232P20QHD	02528508	32	32	170	–	40	34,0	–	1,4	20NR
CER2525M26QHD	02528509	25	25	150	–	40	44,0	–	0,9	26ER
CER3225P26QHD	02528512	32	25	170	–	40	44,0	–	1,2	26ER
CER3232P26QHD	02528516	32	32	170	–	40	44,0	–	1,4	26ER
CEL2525M26QHD	02528511	25	25	150	–	40	44,0	–	0,9	26NR
CEL3225P26QHD	02528513	32	25	170	–	40	44,0	–	1,2	26NR
CEL3232P26QHD	02528517	32	32	170	–	40	44,0	–	1,4	26NR

Spare Parts

For size	Cantilever clamp	Clamp key	Clamp kit	Clamp screw	Insert shim (K)	Shim screw	Spring
..10	-	T15P-2	CSP16-T15P	-	KX10-2	CS2507-T07P	-
..14	CHD16	T15P-2	-	L85020-T15P	KX14-2	CS3507-T09P	S6912
..20	CHD22	T20P-7	-	L86025-T20P	KX20-2	CS4009-T15P	S7616
..26	CHD27	T20P-7	-	L86025-T20P	KX26-2	C05012-T15P	S7616

Accessories

For size	Insert shim (K)	Insert shim (K) 1	Insert shim (K) 2	Insert shim (K) 3	Insert shim (K) 4	Insert shim (K) 5	Insert shim (K) 6	Shim key
..10	KX12-2	-	-	-	-	-	-	T07P-2
..14	-	KX14-0	KX14-1	KX14-3	KX14-4	KX14-5	-	T09P-2
..20	-	KX20-99	KX20-0	KX20-1	KX20-3	KX20-4	KX20-5	T15P-2
..26	-	KX26-99	KX26-0	KX26-1	KX26-3	KX26-4	KX26-5	T15P-2

General / ISO Turning

Steadyline®

MDT

Mini-Shaft™

Grooving

Parting-off

X4

Adapters
Clamping units

Accessories and
Spare parts

Workpiece
materials

General ISO Turning

CER/L. – Toolholders for Precision Grooves – Inch

Steadyline®

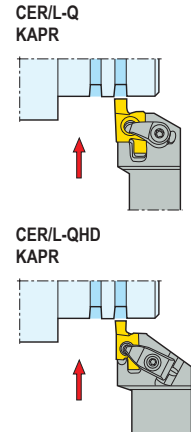
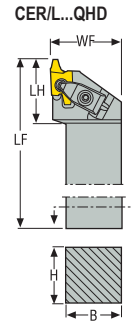
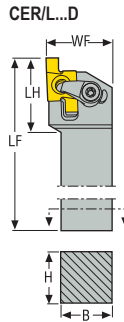

MDT



- For inserts program, see page(s) 900, 902-904, 905
- CTWS = Insert shape and size
- Right-hand version shown
- Please check availability at www.secotools.com / Seco Online Store

Mini-Shaft™

Designation	Item number	H	B	LF 10/14/20/26	LF2 12	WF	LH 10/14/20/26	LH2 12	Weight lbs	CTWS
		Inch	Inch	Inch	Inch	Inch	Inch	Inch		
CER0504-10Q	00072566	0.500	0.500	4.000	–	0.625	0.900	–	0.440	10/12ER
CER0755-10Q	00072564	0.750	0.750	5.000	–	1.000	0.900	–	1.100	10/12ER
CER1006-10Q	00072600	1.000	1.000	6.000	–	1.250	0.900	–	1.980	10/12ER
CEL0755-10Q	00072559	0.750	0.750	5.000	–	1.000	0.900	–	1.100	10/12NR
CEL1006-10Q	00072596	1.000	1.000	6.000	–	1.250	0.900	–	1.980	10/12NR
CER1006-14Q	00072634	1.000	1.000	6.000	–	1.250	1.100	–	1.760	14ER
CEL1006-14Q	00072628	1.000	1.000	6.000	–	1.250	1.100	–	1.980	14NR
CER1006-20QHD	02529045	1.000	1.000	6.000	–	1.250	1.300	–	1.980	20ER
CER1256-20QHD	02529057	1.250	1.250	6.000	–	1.500	1.417	–	2.870	20ER
CEL1006-20QHD	02529053	1.000	1.000	6.000	–	1.250	1.300	–	1.980	20NR
CEL1256-20QHD	02529061	1.250	1.250	6.000	–	1.500	1.300	–	2.870	20NR
CER1006-26QHD	02529063	1.000	1.000	6.000	–	1.250	1.800	–	2.200	26ER
CER1256-26QHD	02529066	1.250	1.250	6.000	–	1.500	1.800	–	3.090	26ER
CER1506-26QHD	02529069	1.500	1.500	6.000	–	1.750	1.800	–	3.970	26ER
CEL1006-26QHD	02529064	1.000	1.000	6.000	–	1.250	1.800	–	2.200	26NR

Grooving

Parting-off

X4

Spare Parts



Adapters
Clamping units

For size	Cantilever clamp	Clamp key	Clamp kit	Clamp screw	Insert shim (K)	Shim screw	Spring
...10	–	T15P-2	CSP16-T15P	–	KX10-2	CS2507-T07P	–
...14	–	T15P-2	CSP16-T15P	–	KX14-2	CS3507-T09P	–
...20	CHD22	T20P-7	–	L86025-T20P	KX20-2	CS4009-T15P	S7616
...26	CHD27	T20P-7	–	L86025-T20P	KX26-2	C05012-T15P	S7616

Accessories and
Spare parts

Workpiece
materials

Accessories

For size	Insert shim (K)	Insert shim (K) 1	Insert shim (K) 2	Insert shim (K) 3	Insert shim (K) 4	Insert shim (K) 5	Insert shim (K) 6	Shim key
..-10	 KX12-2	-	-	-	-	-	-	 T07P-2
..-14	-	-	-	-	-	-	-	T09P-2
..-20	-	KX20-99	KX20-0	KX20-1	KX20-3	KX20-4	KX20-5	T15P-2
..-26	-	KX26-99	KX26-0	KX26-1	KX26-3	KX26-4	KX26-5	T15P-2

General ISO Turning

Steadyline®

MDT

Mini-Shaft™

Grooving

Parting-off

X4

Adapters
Clamping units

Accessories and
Spare parts

Workpiece
materials

CEAR/L – Toolholders for Precision Axial Grooves – Metric

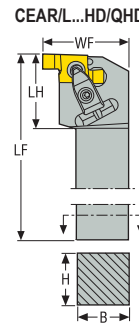
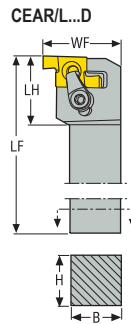

CEAR/L...D/HD/QHD
KAPR = 90,0 °

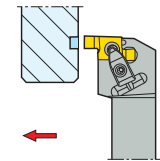

CTWS



- For inserts program, see page(s) 901, 904
- * For INPLM, see page(s) 881
- CTWS = Insert shape and size
- Shim KX12-2 for insert 12..
- Right-hand version shown
- WF (10../14../20..) = WF2 (12..)
- Please check availability at www.secotools.com / Seco Online Store

Designation	Item number	H	B	LF	WF 10../14../20..	WF2 12	LH	INPLM* 10../14../20..	INPLM* 12..	Weight	CTWS
		mm	mm	mm	mm	mm	mm	mm	mm	kg	
CEAR2525M10D	02411447	25	25	150	35,4	38,4	22	16	18,0	0,8	10/12EAR
CEAL2525M10D	02411448	25	25	150	35,4	38,4	22	16	18,0	0,8	10/12EAL
CEAR2525M14HD	02627517	25	25	150	36,9	–	31	22	–	0,8	14EAR
CEAL2525M14HD	02627516	25	25	150	36,9	–	31	22	–	0,8	14EAL
CEAR2525M20QHD	02528518	25	25	150	39,4	–	35	28	–	0,9	20EAR
CEAL2525M20QHD	02528519	25	25	150	39,4	–	35	28	–	0,9	20EAL

Spare Parts

For size	Cantilever clamp	Clamp key	Clamp kit	Clamp screw	Insert shim (KL)	Insert shim (KR)	Shim screw	Spring
CEAR..10	–	T15P-2	CSP16-T15P	–	–	AKR10	CS2507-T07P	–
CEAL..10	–	T15P-2	CSP16-T15P	–	AKL10	–	CS2507-T07P	–
CEAR..14	CHD16	T15P-2	–	L85020-T15P	–	AKR14	CS3507-T09P	S6912
CEAL..14	CHD16	T15P-2	–	L85020-T15P	AKL14	–	CS3507-T09P	S6912
CEAR..20	CHD22	T20P-7	–	L86025-T20P	–	AKR20	CS4009-T15P	S7616
CEAL..20	CHD22	T20P-7	–	L86025-T20P	AKL20	–	CS4009-T15P	S7616

Accessories

For size	Insert shim (K)	Shim key
CEAR..10	KX12-2	T07P-2
CEAL..10	KX12-2	T07P-2
CEAR..14	–	T09P-2
CEAL..14	–	T09P-2
CEAR..20	–	T15P-2
CEAL..20	–	T15P-2

CEAR/L – Toolholders for Precision Axial Grooves – Inch

CEAR/L
KAPR = 90,0°

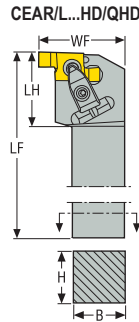
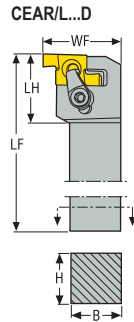
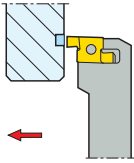

- For inserts program, see page(s) 901, 904
- * For INPLM, see page(s) 881
- CTWS = Insert shape and size
- Shim KX12-2 for insert 12..
- Right-hand version shown
- WF (10../14..) = WF2 (12..)
- Please check availability at www.secotools.com / Seco Online Store

Designation	Item number	H	B	LF	WF 10/14	WF2 12	LH	INPLM* 10/14	INPLM* 12..	Weight	CTWS
		Inch	Inch	Inch	Inch	Inch	Inch	Inch	Inch	lbs	
CEAR1006-10	00072625	1.000	1.000	6.000	1.392	1.510	1.110	0.630	0.709	2.200	10/12EAR
CEAL1006-10	00072613	1.000	1.000	6.000	1.392	1.510	1.110	0.630	0.709	1.980	10/12EAL
CEAR1006-14	00072623	1.000	1.000	6.000	1.451	-	1.110	0.866	-	2.200	14EAR

Spare Parts

For size	Clamp key	Clamp kit	Insert shim	Insert shim (KL)	Insert shim (KR)	Shim key	Shim screw
CEAR...10				-		-	
CEAL...10			-		-	-	
CEAR...14				-	-		

Accessories

For size	Insert shim (K)	Shim key
CEAR...10	-	
CEAL...10		
CEAR...14	-	-

General ISO Turning

Steadyline®

MDT

Mini-Shaft™

Grooving

Parting-off

X4

Adapters Clamping units

Accessories and Spare parts

Workpiece materials

General ISO Turning

Steadyline®

MDT

Mini-Shaft™

Grooving

Parting-off

X4

Adapters
Clamping units

Accessories and
Spare parts

Workpiece
materials

SNR/L – Toolholders for Precision Grooves – Metric

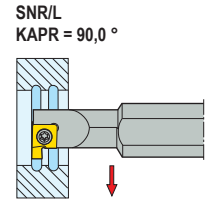
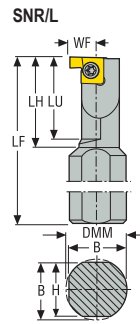
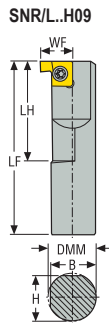



CTWS



- For inserts program, see page(s) 899
- * DCINN – minimum bore diameter, see page(s) 881
- CTWS = Insert shape and size
- Right-hand version shown
- Please check availability at www.secotools.com / Seco Online Store

Designation	Item number	DMM	H	B	LF	WF	LH	LU	DCINN*	Weight	CTWS
		mm	mm	mm	mm	mm	mm	mm	mm	kg	
SNR0010H9	75025330	10	9,5	9,5	100	7,5	20	–	14	0,1	9NR
SNR0010K9	75025332	16	15,5	15,5	125	6,5	25	23	14	0,2	9NR
SNR0013L9	75025334	16	15,5	15,5	140	8,0	32	30	17	0,2	9NR
SNR0016M9	75025336	16	15,5	15,5	150	9,5	40	38	20	0,3	9NR
SNL0010H9	75025331	10	9,5	9,5	100	7,5	20	–	14	0,1	9NL
SNL0010K9	75025333	16	15,5	15,5	125	6,5	25	23	14	0,2	9NL
SNL0013L9	75025335	16	15,5	15,5	140	8,0	32	30	17	0,2	9NL
SNL0016M9	75025337	16	15,5	15,5	150	9,5	40	38	20	0,3	9NL

Spare Parts

For size	Insert key	Insert screw
..9	 T07P-2	 C02506-T07P

SNR/L – Toolholders for Precision Grooves – Inch

SNR/L
KAPR

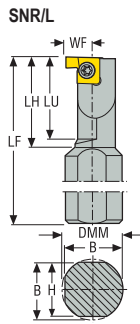
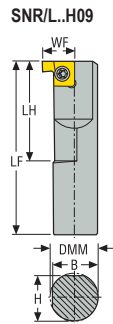
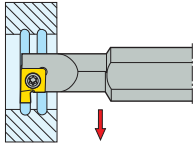



CTWS



- For inserts program, see page(s) 899
- * DCINN – minimum bore diameter, see page(s) 881
- CTWS = Insert shape and size
- Right-hand version shown
- Please check availability at www.secotools.com / Seco Online Store

Designation	Item number	DMM	H	B	LF	WF	LH	LU	DCINN*	Weight	CTWS
		Inch	Inch	Inch	Inch	Inch	Inch	Inch	Inch	lbs	
SNR000375-50-9	00072560	0.375	0.625	0.654	5.000	0.266	1.000	–	0.550	0.440	9..
SNR00050-55-9	00072586	0.500	0.441	0.470	5.500	0.319	1.250	–	0.700	0.660	9..
SNR000625-60-9	00072588	0.625	0.566	0.587	6.000	0.378	1.500	–	0.800	0.660	9..
SNL00037540-9	00072552	0.375	0.336	0.350	4.000	0.299	–	–	0.550	0.220	9..
SNL00037550-9	00072595	0.375	0.336	0.350	5.000	0.259	1.000	–	0.550	0.440	9..
SNR000375-60-9H	00072562	0.375	0.441	0.350	6.000	0.299	–	–	0.550	0.660	9..

Spare Parts

For size	Insert key	Insert screw
..9	 T07P-2	 C02506-T07P

General / ISO Turning

Steadyline®

MDT

Mini-Shaft™

Grooving

Parting-off

X4

Adapters
Clamping units

Accessories and
Spare parts

Workpiece
materials

CNR/L – Toolholders for Precision Grooves – Metric

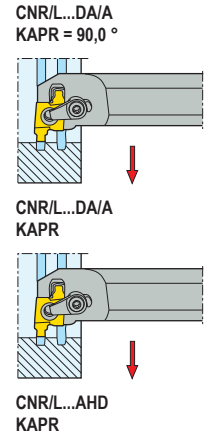
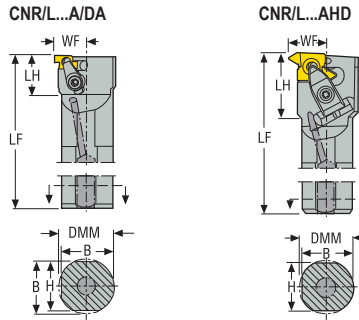

- For inserts program, see page(s) 900, 902-904, 905
- * DCINN – minimum bore diameter, see page(s) 881
- CTWS = Insert shape and size
- Shim KX12-2 for insert 12..
- Right-hand version shown
- WF (10../14../20../26..) = WF2 (12..)
- Please check availability at www.secotools.com / Seco Online Store

Designation	Item number	DMM	H	B	LF	WF	WF2	LH	DCINN*	DCINN2	Weight	CTWS
							12					
		mm	mm	mm	mm	mm	mm	mm	mm	mm	kg	
CNR0020P10DA	02411454	20	18	19	170	13,5	16,5	26	26	29	0,4	10/12NR
CNR0025R10DA	02411459	25	23	24	200	16,0	19,0	28	31	34	0,7	10/12NR
CNR0032S10DA	02411467	32	30	31	250	19,5	22,5	31	38	41	1,4	10/12NR
CNL0020P10DA	02411456	20	18	19	170	13,5	16,5	26	26	29	0,4	10/12ER
CNL0025R10DA	02411464	25	23	24	200	16,0	19,0	28	31	34	0,7	10/12ER
CNL0032S10DA	02411468	32	30	31	250	19,5	22,5	31	38	41	1,4	10/12ER
CNR0020P14A	00040041	20	18	19	170	15,0	-	32	30	-	0,4	14..
CNR0025R14A	00040042	25	23	24	200	17,5	-	45	34	-	0,7	14..
CNR0032S14A	00040043	32	30	31	250	21,0	-	48	40	-	1,4	14..
CNR0040T14A	00040044	40	37	39	300	25,0	-	50	48	-	2,6	14..
CNL0020P14A	00040045	20	18	19	170	15,0	-	32	30	-	0,4	14..
CNL0025R14A	00040046	25	23	24	200	17,5	-	45	34	-	0,7	14..
CNL0032S14A	00040047	32	30	31	250	21,0	-	48	40	-	1,4	14..
CNR0025R20AHD	02556131	25	23	24	200	20,5	-	50	38	-	0,7	20..
CNR0032S20AHD	02556132	32	30	31	250	24,0	-	50	44	38	1,5	20..
CNR0040T20AHD	02556133	40	37	39	300	28,0	-	50	51	40	2,6	20..
CNL0025R20AHD	02556134	25	23	24	200	20,5	-	50	38	-	0,7	20..
CNL0032S20AHD	02556135	32	30	31	250	24,0	-	50	44	38	1,4	20..
CNR0032S26AHD	02556136	32	30	31	250	27,0	-	61	50	50	1,5	26..
CNR0040T26AHD	02556137	40	37	39	300	31,0	-	60	55	50	2,6	26..
CNR0050U26AHD	02556138	50	47	49	350	36,0	-	62	65	-	4,8	26..
CNR0063V26AHD	02556139	63	60	62	400	42,5	-	64	80	63	8,9	26..
CNL0040T26AHD	02556140	40	37	39	300	31,0	-	60	55	50	2,6	26..

Spare Parts

For size	Cantilever clamp	Clamp key	Clamp kit	Clamp screw	Insert shim (K)	Shim screw	Spring
..10	-	T15P-2	CSP16-T15P	-	KX10-2	CS2507-T07P	-
..14	-	T15P-2	CSP16-T15P	-	KX14-2	CS3507-T09P	-
..20	CHD22	T20P-7L	-	L86025-T20P	KX20-2	CS4009-T15P	S7616
..26	CHD27	T20P-7L	-	L86025-T20P	KX26-2	C05012-T15P	S7616

Accessories

For size	Insert shim (K)	Insert shim (K) 1	Insert shim (K) 2	Insert shim (K) 3	Insert shim (K) 4	Insert shim (K) 5	Insert shim (K) 6	Shim key
..10	KX12-2	-	-	-	-	-	-	T07P-2
..14	-	-	-	-	-	-	-	T09P-2
..20	-	KX20-99	KX20-0	KX20-1	KX20-3	KX20-4	KX20-5	T15P-2
..26	-	KX26-99	KX26-0	KX26-1	KX26-3	KX26-4	KX26-5	T15P-2

General ISO Turning

Steadyline®

MDT

Mini-Shaft™

Grooving

Parting-off

X4

Adapters
Clamping units

Accessories and
Spare parts

Workpiece
materials

CNR/L – Toolholders for Precision Grooves – Inch

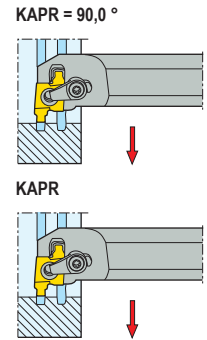
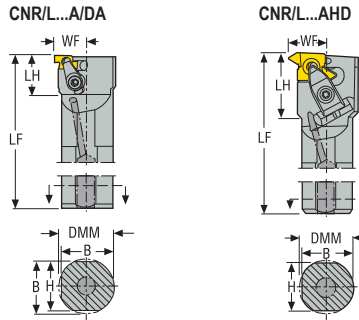

- For inserts program, see page(s) 900, 902-904, 905
- * DCINN – minimum bore diameter, see page(s) 881
- CTWS = Insert shape and size
- Shim KX12-2 for insert 12..
- Right-hand version shown
- WF (10../14../20../26..) = WF2 (12..)
- Please check availability at www.secotools.com / Seco Online Store

Designation	Item number	DMM	H	B	LF	WF	WF2 12	LH	DCINN*	DCINN2	Weight	CTWS
		Inch	Inch	Inch	Inch	Inch	Inch	Inch	Inch	Inch	lbs	
CNR000757-10	00072573	0.750	0.691	0.707	7.000	0.490	0.608	1.480	0.950	0.950	1.100	10/12NR
CNR001008-10	00072569	1.000	0.921	0.957	8.000	0.618	0.736	2.500	1.200	1.000	1.760	10/12NR
CNR0012510-10	00072563	1.250	1.150	1.209	10.000	0.750	0.868	1.772	1.500	1.250	3.310	10/12NR
CNR0015012-10	00072592	1.500	1.339	1.427	12.008	0.858	0.976	1.772	1.800	1.600	5.730	10/12NR
CNL000757-10	00072624	0.750	0.650	0.707	7.000	0.490	0.608	1.480	0.950	0.950	0.880	10/12ER
CNL001008-10	00072610	1.000	0.902	0.957	8.000	0.620	0.738	1.559	1.200	1.000	1.760	10/12ER
CNR00075010-10-H	00072583	0.750	0.691	0.730	10.000	0.490	-	1.480	0.950	0.950	2.650	10/12NR
CNR000757-14	00072571	0.750	0.691	0.707	7.000	0.570	-	1.693	1.050	1.050	0.880	14..
CNR001008-14	00072567	1.000	0.921	0.957	8.000	0.700	-	1.732	1.300	1.050	1.980	14..
CNL001008-14	00072582	1.000	1.000	0.961	8.000	0.704	-	-	1.182	1.050	1.760	14..
CNR001008-20AHD	02562823	1.000	0.902	0.957	7.992	0.705	-	1.969	1.400	-	1.540	20..
CNR0012510-20AHD	02562824	1.250	1.150	1.209	10.000	0.945	-	2.165	1.700	1.400	3.310	20..
CNR0015012-20AHD	02562825	1.500	1.339	1.427	12.008	1.063	-	2.165	2.000	1.600	5.510	20..
CNL001008-20AHD	02562826	1.000	0.902	0.957	7.992	0.705	-	1.969	1.400	-	1.540	20..
CNL0012510-20AHD	02562827	1.250	1.150	1.209	10.000	0.945	-	2.165	1.700	1.400	3.310	20..
CNL0015012-20AHD	02562828	1.500	1.339	1.427	12.008	1.063	-	2.165	2.000	1.600	5.510	20..
CNR0012510-26AHD	02562830	1.250	1.150	1.209	10.000	1.063	-	2.323	2.000	1.600	3.090	26..
CNR0015012-26AHD	02562831	1.500	1.339	1.427	12.008	1.183	-	2.323	2.100	2.100	5.510	26..
CNR0017514-26AHD	02562832	1.750	1.591	1.677	13.976	1.307	-	2.283	2.300	1.800	8.820	26..
CNR0020014-26AHD	02562833	2.000	1.843	1.929	13.976	1.433	-	2.283	2.500	2.000	11.460	26..
CNR0025016-26AHD	02562834	2.500	2.343	2.429	15.984	1.683	-	2.283	3.000	2.500	20.720	26..
CNL0012510-26AHD	02564043	1.250	1.150	1.209	10.000	1.063	-	2.323	2.000	1.600	3.090	26..
CNL0015012-26AHD	02563555	1.500	1.339	1.427	12.008	1.177	-	2.323	2.100	2.100	5.510	26..
CNL0017514-26AHD	02563563	1.750	1.591	1.677	13.976	1.307	-	2.283	2.300	1.800	8.820	26..
CNL0025016-26AHD	02563564	2.500	2.343	2.429	15.984	1.683	-	2.283	3.000	2.500	20.720	26..

Spare Parts

For size	Cantilever clamp	Clamp key	Clamp kit	Clamp screw	Insert shim (K)	Shim screw	Spring
..-10	-	T15P-2	CSP16-T15P	-	KX10-2	CS2507-T07P	-
..-10-10-H	-	T15P-2	CSP16-T15P	-	KX10-2	CS2507-T07P	-
..-14	-	T15P-2	CSP16-T15P	-	KX14-2	CS3507-T09P	-
..-20	CHD22	T20P-7	-	L86025-T20P	KX20-2	CS4009-T15P	S7616
..-26	CHD27	T20P-7	-	L86025-T20P	KX26-2	C05012-T15P	S7616

Accessories

For size	Insert shim (K)	Insert shim (K) 1	Insert shim (K) 2	Insert shim (K) 3	Insert shim (K) 4	Insert shim (K) 5	Insert shim (K) 6	Shim key
..-10	KX12-2	-	-	-	-	-	-	T07P-2
..-10-10-H	-	-	-	-	-	-	-	T07P-2
..-14	-	-	-	-	-	-	-	-
..-20	-	KX20-99	KX20-0	KX20-1	KX20-3	KX20-4	KX20-5	T15P-2
..-26	-	KX26-99	KX26-0	KX26-1	KX26-3	KX26-4	KX26-5	T15P-2

General ISO Turning
Steadyline®
MDT
Mini-Shaft™
Grooving
Parting-off
X4
Adapters Clamping units
Accessories and Spare parts
Workpiece materials

General ISO Turning

CF.R/L-.C – Toolholders for ceramic inserts LPGN – Metric

Steadyline®

MDT

Mini-Shaft™

Grooving

Parting-off

X4

Adapters
Clamping units

Accessories and
Spare parts

Workpiece
materials

CF.R/L-.C
KAPR = 90,0 °

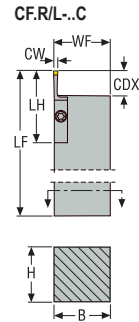
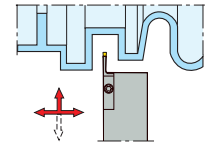

CTWS



- For inserts program, see page(s) 906
- CTWS = Insert shape and size
- Right-hand version shown

Designation	Item number	H	B	LF	WF	LH	CDX	Weight	CW	CTWS
		mm	mm	mm	mm	mm	mm	kg	mm	
CFOR3244M-0317C	02927353	32	44	150	44,2	56,4	19,4	1,5	3,17	LPGN1204..
CFOL3244M-0317C	02927354	32	44	150	44,2	56,4	19,4	1,5	3,17	LPGN1204..
CFLR3244M-0635C	02464154	32	44	150	44,6	66,6	29,1	1,5	6,35	LPGN1906..
CFL3244M-0635C	02464113	32	44	150	44,6	66,6	29,1	1,5	6,35	LPGN1906..
CFKR3244M-0952C	02464109	32	44	150	45,0	76,8	38,5	1,5	9,52	LPGN2508..
CFKL3244M-0952C	02544163	32	44	150	45,0	76,8	38,5	1,4	9,52	LPGN2508..

Spare Parts

For size	Clamp	Clamp key
-0317C	CER024	T30P-7
-0317C	CEL024	T30P-7
-0635C	CER055	T30P-7
-0635C	CEL055	T30P-7
-0952C	CER087	T30P-7
-0952C	CEL087	T30P-7

Please check availability at www.secotools.com / Seco Online Store

Tolerances:
 CW = +0,05/0 / +0,002/0
 Toolholder range, see page(s) 892, 893

Inserts – Precision Grooves, Radial Grooves

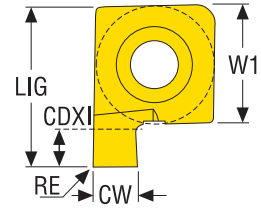

9



CW	W1	LIG	CDXI	RE	For circlip	Pitch TPI	Designation Internal left	Grades		Designation Internal right	Grades	
								Coated			Coated	
mm Inch	mm Inch	mm Inch	mm Inch	mm Inch	mm Inch			CP30	CP500		CP30	CP500
1,15 0.045	6.35 0.250	9,0 0.354	1,15 0.045	0,0	1,00 0.039	-	9NL1.15FG	■	■	9NR1.15FG	■	■
1,35 0.053	6.35 0.250	9,0 0.354	1,35 0.053	0,0	1,20 0.047	-	9NL1.35FG		■	9NR1.35FG	■	■
1,65 0.065	6.35 0.250	9,0 0.354	1,65 0.065	0,0	1,50 0.059	-	9NL1.65FG		■	9NR1.65FG	■	■
1,9 0.075	6.35 0.250	9,0 0.354	1,9 0.075	0,0	1,75 0.069	-	9NL1.9FG		■	9NR1.9FG	■	■
2,15 0.085	6.35 0.250	9,0 0.354	2,15 0.085	0,0	2,00 0.079	6TPI	9NL2.15FG		■	9NR2.15FG	■	■
2,65 0.104	6.35 0.250	9,0 0.354	2,65 0.104	0,0	2,50 0.098	-	9NL2.65FG	■	■	9NR2.65FG	■	■

General ISO Turning

Steadyline®

MDT

Mini-Shaft™

Grooving

Parting-off

X4

Adapters and Clamping units

Accessories and Spare parts

Workpiece materials

Inserts – Precision Grooves, Radial Grooves

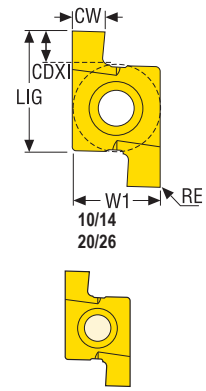

Tolerances:
CW = +0,05/0 / +0.002/0
Toolholder range, see page(s) 885, 886, 887, 888, 889, 894, 895, 896, 897

Please check availability at www.secotools.com / Seco Online Store

Toolset 10FG, CP500 contents:
1 pce 10ER1.15FG, 1 pce 10ER1.35FG
1 pce 10ER1.65FG, 1 pce 10ER1.9FG
1 pce 10ER2.15FG, 1 pce 10NR1.15FG
1 pce 10NR1.35FG, 1 pce 10NR1.65FG
1 pce 10NR1.9FG, 1 pce 10NR2.15FG

CW	W1	LIG	CDXI	RE	For circlip	Pitch TPI	Designation External right Internal left	Grades		Designation Internal right External left	Grades	
								Coated			Coated	
mm Inch	mm Inch	mm Inch	mm Inch	mm Inch	mm Inch			CP30	CP500		CP30	CP500
1,15 0.045	6,35 0.250	9,0 0.354	1,15 0.045	0,0	1,00 0.039	-	10ER1.15FG	■	■	10NR1.15FG	■	■
1,35 0.053	6,35 0.250	9,0 0.354	1,35 0.053	0,0	1,20 0.047	-	10ER1.35FG	■	■	10NR1.35FG	■	■
1,65 0.065	6,35 0.250	9,0 0.354	1,65 0.065	0,0	1,50 0.059	-	10ER1.65FG	■	■	10NR1.65FG	■	■
1,9 0.075	6,35 0.250	9,0 0.354	1,9 0.075	0,0	1,75 0.069	-	10ER1.9FG	■	■	10NR1.9FG	■	■
2,15 0.085	6,35 0.250	9,0 0.354	2,15 0.085	0,0	2,00 0.079	6TPI	10ER2.15FG	■	■	10NR2.15FG	■	■
2,65 0.104	6,35 0.250	9,0 0.354	2,65 0.104	0,0	2,50 0.098	-	10ER2.65FG	■	■	10NR2.65FG	■	■
3,0 0.118	9,525 0.375	14,0 0.551	3,0 0.118	0,0	-	-	14ER3.0FG	■	■	14NR3.0FG	■	■
3,2 0.126	9,525 0.375	14,0 0.551	3,2 0.126	0,0	3,00 0.118	-	14ER3.2FG	■	■	14NR3.2FG	■	■
3,4 0.134	9,525 0.375	14,0 0.551	3,4 0.134	0,0	-	4TPI	14ER3.4FG	■	■	14NR3.4FG	■	■
4,0 0.157	9,525 0.375	14,0 0.551	4,0 0.157	0,0	-	-	14ER4.0FG	■	■	14NR4.0FG	■	■
4,2 0.165	9,525 0.375	14,0 0.551	4,2 0.165	0,0	4,00 0.157	-	14ER4.2FG	■	■	14NR4.2FG	■	■
4,4 0.173	12,7 0.500	2 0.787	4,4 0.173	0,0	-	3TPI	20ER4.4FG	■	■	20NR4.4FG	■	■
5,0 0.197	12,7 0.500	2 0.787	5,0 0.197	0,0	-	-	20ER5.0FG	■	■	20NR5.0FG	■	■
5,2 0.205	12,7 0.500	2 0.787	5,2 0.205	0,0	5,00 0.197	-	20ER5.2FG	■	■	20NR5.2FG	■	■
6,0 0.236	12,7 0.500	2 0.787	6,0 0.236	0,0	-	-	20ER6.0FG	■	■	20NR6.0FG	■	■
6,35 0.250	12,7 0.500	2 0.787	6,35 0.250	0,0	-	-	20ER6.35FG	■	■	20NR6.35FG	■	■
8,0 0.315	15,875 0.625	26,0 1.024	8,0 0.315	0,0	-	-	26ER8.0FG	■	■	26NR8.0FG	■	■
1 0.394	15,875 0.625	26,0 1.024	1 0.394	0,0	-	-	26ER10.0FG	■	■	26NR10.0FG	■	■
-	-	-	-	-	-	-	10FG	■	■			

Inserts – Precision Grooves, Axial Grooves

Please check availability at www.secotools.com / Seco Online Store

Tolerances:
CW = +0,05/0 / +0,002/0
Toolholder range and INPLM, see page(s) 890, 891

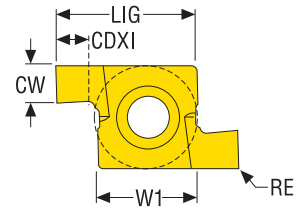

10

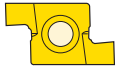

12



14/20



CW	W1	LIG	CDXI	RE	INPLM	For width	Designation External right	Grades		Designation External left	Grades	
								Coated			Coated	
mm Inch	mm Inch	mm Inch	mm Inch	mm Inch	mm Inch	mm Inch		CP30	CP500		CP30	CP500
2,5 0.098	6,35 0.250	9,0 0.354	2,5 0.098	-	16,0 0.630	2,5 0.098	10EAR2.5FA	■	■	10EAL2.5FA		■
2,5 0.098	6,35 0.250	12,0 0.472	5,0 0.197	0,2 0.008	18,0 0.709	2,5 0.098	12EAR2.5FD		■	12EAL2.5FD		■
4,0 0.157	9,525 0.375	14,0 0.551	4,0 0.157	-	22,0 0.866	4,0 0.157	14EAR4.0FA	■	■	14EAL4.0FA	■	■
6,0 0.236	12,7 0.500	2 0.787	6,0 0.236	-	28,0 1.102	6,0 0.236	20EAR6.0FA	■	■	20EAL6.0FA		■

General ISO Turning

Steadyline®

MDT

Mini-Shaft™

Grooving

Parting-off

X4

Adapters
Clamping units

Accessories and
Spare parts

Workpiece
materials

Inserts – Precision Grooves, Deep Radial Grooves

Please check availability at www.secotools.com / Seco Online Store

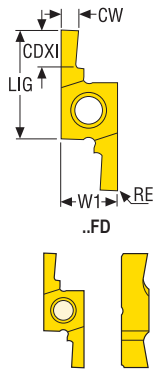

Tolerances:
CW= ±0,025/0.001
CDXI = +0,10/0 / +0,004/0
Toolholder range, see page(s) 885, 886, 887, 888, 889, 894, 895, 896, 897

W1	LIG	CW	CDXI	RE	Designation External right Internal left	Grades		Designation Internal right External left	Grades	
						Coated			Coated	
mm Inch	mm Inch	mm Inch	mm Inch	mm Inch		CP30	CP500		CP30	CP500
6,35 0.250	9,0 0.354	0,5 0.020	1,0 0.039	–	10ER0.50FD		■	10NR0.50FD		■
6,35 0.250	9,0 0.354	0,8 0.031	1,6 0.063	–	10ER0.80FD		■	10NR0.80FD		■
6,35 0.250	9,0 0.354	1,0 0.039	2,0 0.079	–	10ER1.00FD		■	10NR1.00FD		■
6,35 0.250	12,0 0.472	1,04 0.041	2,08 0.082	–	12ER1.04FD		■	12NR1.04FD		■
6,35 0.250	12,0 0.472	1,2 0.047	2,4 0.094	0,1 0.004	12ER1.20FD		■	12NR1.20FD		■
6,35 0.250	12,0 0.472	1,4 0.055	2,8 0.110	0,1 0.004	12ER1.40FD		■	12NR1.40FD		■
6,35 0.250	12,0 0.472	1,47 0.058	2,94 0.116	0,1 0.004	12ER1.47FD		■	12NR1.47FD		■
6,35 0.250	12,0 0.472	1,5 0.059	3,0 0.118	0,1 0.004	12ER1.50FD		■	12NR1.50FD		■
6,35 0.250	12,0 0.472	1,57 0.062	3,14 0.124	0,15 0.006	12ER1.57FD		■	12NR1.57FD		■
6,35 0.250	12,0 0.472	1,7 0.067	3,4 0.134	0,15 0.006	12ER1.70FD		■	12NR1.70FD		■
6,35 0.250	12,0 0.472	1,96 0.077	3,92 0.154	0,15 0.006	12ER1.96FD		■	12NR1.96FD		■
6,35 0.250	12,0 0.472	2,0 0.079	4,0 0.157	0,2 0.008	12ER2.00FD		■	12NR2.00FD		■
6,35 0.250	12,0 0.472	2,24 0.088	4,48 0.176	0,2 0.008	12ER2.24FD		■	12NR2.24FD		■
6,35 0.250	12,0 0.472	2,3 0.091	4,6 0.181	0,2 0.008	12ER2.30FD		■	12NR2.30FD		■
6,35 0.250	12,0 0.472	2,39 0.094	4,78 0.188	0,2 0.008	12ER2.39FD		■	12NR2.39FD		■
6,35 0.250	12,0 0.472	2,65 0.104	5,3 0.209	0,2 0.008	12ER2.65FD		■	12NR2.65FD		■

Please check availability at www.secotools.com / Seco Online Store

Tolerances:
 RE = ±0,05/0,002
 Toolholder range, see page(s) 885, 886, 887, 888, 889, 894, 895, 896, 897

Inserts – Precision Grooves, DIN76

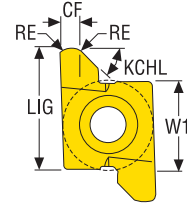

..D76

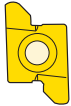

CF	W1	LIG	RE	For max pitch	KCHR°	KCHL°	Designation External right Internal left	Grades		Designation Internal right External left	KCHR°	KCHL°	Grades	
								Coated					Coated	
mm Inch	mm Inch	mm Inch	mm Inch	mm Inch				CP30	CP500				CP30	CP500
2,0 0.079	6,35 0.250	9,0 0.354	0,5 0.020	1,0 0.039	0	45	10ER1.0D76		■	10NR1.0D76	45	0		■
3,1 0.122	9,525 0.375	14,0 0.551	0,75 0.030	1,5 0.059	0	45	14ER1.5D76	■	■	14NR1.5D76	45	0		■
4,5 0.177	12,7 0.500	20,0 0.787	1,0 0.039	2,0 0.079	0	45	20ER2.0D76		■	20NR2.0D76	45	0		■

Please check availability at www.secotools.com / Seco Online Store

Tolerances:
 RE = ±0,05/0,002
 Toolholder range, see page(s) 885, 886, 887, 888, 889, 894, 895, 896, 897

Inserts – Precision Grooves, Radius

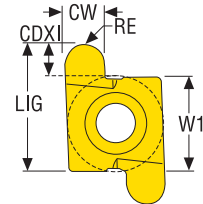

..R

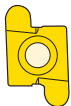

W1	LIG	CW	CDXI	RE	For radius	Designation External right Internal left	Grades		Designation Internal right External left	Grades	
							Coated			Coated	
mm Inch	mm Inch	mm Inch	mm Inch	mm Inch	mm Inch		CP30	CP500		CP30	CP500
6,35 0.250	9,0 0.354	2,0 0.079	2,4 0.094	1,0 0.039	1,0 0.039	10ER1.0R		■	10NR1.0R		■
6,35 0.250	9,0 0.354	2,4 0.094	2,4 0.094	1,2 0.047	1,2 0.047	10ER1.2R		■	10NR1.2R	■	■
9,525 0.375	14,0 0.551	3,0 0.118	4,28 0.169	1,5 0.059	1,5 0.059	14ER1.5R	■	■	14NR1.5R	■	■
9,525 0.375	14,0 0.551	4,0 0.157	4,28 0.169	2,0 0.079	2,0 0.079	14ER2.0R	■	■	14NR2.0R		■
12,7 0.500	2 0.787	6,0 0.236	6,9 0.272	3,0 0.118	3,0 0.118	20ER3.0R	■	■	20NR3.0R	■	■
15,875 0.625	26,0 1.024	8,0 0.315	9,8 0.386	4,0 0.157	4,0 0.157	26ER4.0R		■	26NR4.0R		■
15,875 0.625	26,0 1.024	1 0.394	9,8 0.386	5,0 0.197	5,0 0.197	26ER5.0R		■	26NR5.0R		■

General ISO Turning

Inserts – Precision Grooves, O-ring Static

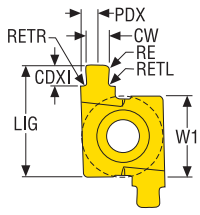

..ST

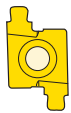

Steadyline®

Tolerances:
 CW = +0,07/-0,03 / +0.003/-0.0012
 RETR/RETL = ±0,05/0.002
 RE = ±0,15/0.006
 CDXI = ±0,025/0.001
 Toolholder range, see page(s) 885, 886, 887, 888, 889, 894, 895, 896, 897

Please check availability at www.secotools.com / Seco Online Store

Standard
 * =
 SMS 1588, BS 4518
 ** =
 ISO 3601, DIN 3771, BS 1806

MDT

CW	PDX	W1	LIG	RETR	RETL	CDXI	RE	For O-ring		Stand-ard	Designation External right Internal left	Grades		Grades	
								Coated	Designation Internal right External left			Coated	Coated		
mm Inch	mm Inch	mm Inch	mm Inch	mm Inch	mm Inch	mm Inch	mm Inch	Inch	Inch			CP30	CP500	CP30	CP500
2,4 0.094	2,0 0.079	9,525 0.375	14,0 0.551	0,2 0.008	0,2 0.008	1,11 0.044	0,5 0.020	1,60	–	*	14ER1.6ST	■	14NR1.6ST		■
3,2 0.126	2,0 0.079	9,525 0.375	14,0 0.551	0,23 0.009	0,23 0.009	1,78 0.070	0,5 0.020	2,40	–	*	14ER2.4ST	■	14NR2.4ST		■
3,8 0.150	3,2 0.126	12,7 0.500	2 0.787	0,3 0.012	0,3 0.012	2,25 0.089	1,0 0.039	3,00	–	*	20ER3.0ST	■	20NR3.0ST		■
4,8 0.189	3,2 0.126	12,7 0.500	2 0.787	0,3 0.012	0,3 0.012	2,64 0.104	0,75 0.030	3,55	0.140	**	20ER3.55ST	■	20NR3.55ST		
5,1 0.201	3,2 0.126	12,7 0.500	2 0.787	0,4 0.016	0,4 0.016	3,19 0.126	1,0 0.039	4,10	–	*	20ER4.1ST	■	20NR4.1ST		
6,5 0.256	5,0 0.197	15,875 0.625	26,0 1.024	0,4 0.016	0,4 0.016	4,56 0.180	1,0 0.039	5,70	–	*	26ER5.7ST	■	26NR5.7ST		■

Parting-off

Inserts – Precision Grooves, O-ring Axial

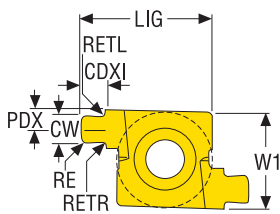

..AX

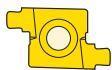

X4

Tolerances:
 CW = +0,07/-0,03 / +0.003/-0.0012
 RETR/RETL = ±0,05/0.002
 RE = ±0,15/0.006
 CDXI = ±0,025/0.001
 Toolholder range, see page(s) 890, 891

Please check availability at www.secotools.com / Seco Online Store

Standard
 * =
 SMS 1588, BS 4518
 ** =
 ISO 3601, DIN 3771, BS 1806

Adapters
Clamping units

CW	PDX	W1	LIG	RETR	RETL	CDXI	RE	For O-ring		Stand-ard	Designation External right External left	Grades		Grades	
								Coated	Designation External left			Coated	Coated		
mm Inch	mm Inch	mm Inch	mm Inch	mm Inch	mm Inch	mm Inch	mm Inch	Inch	Inch			CP30	CP500	CP30	CP500
3,4 0.134	2,0 0.079	9,525 0.375	14,0 0.551	0,2 0.008	0,2 0.008	1,6 0.063	0,5 0.020	2,40	–	*	14EAR2.4AX	■	14EAL2.4AX		■
4,2 0.165	3,2 0.126	12,7 0.500	2 0.787	0,25 0.010	0,25 0.010	2,07 0.081	1,0 0.039	3,00	–	*	20EAR3.0AX	■	20EAL3.0AX		
3,6 0.142	2,1 0.083	9,525 0.375	14,0 0.551	0,25 0.010	0,25 0.010	2,07 0.081	0,5 0.020	2,65	0.104	**	14EAR2.65AX	■	14EAL2.65AX		
4,9 0.193	3,2 0.126	12,7 0.500	2 0.787	0,3 0.012	0,3 0.012	2,79 0.110	0,75 0.030	3,55	0.140	**	20EAR3.55AX	■	20EAL3.55AX		

Accessories and
Spare parts

Workpiece
materials

Inserts – Precision Grooves, O-ring Dynamic

Please check availability at www.secotools.com / Seco Online Store

Standard

* =
SMS 1588, BS 4518

** =
ISO 3601, DIN 3771, BS 1806

Tolerances:

CW = +0,07/-0,03 / +0.003/-0.0012

RETR/RETL = ±0,05/0.002

RE = ±0,15/0.006

CDXI = ±0,025/0.001

Toolholder range, see page(s) 885, 886, 887, 888, 889, 894, 895, 896, 897

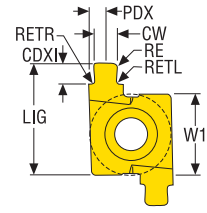

..DY

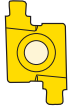

											Grades		Grades		
CW	PDX	W1	LIG	RETR	RETL	CDXI	RE	For O-ring		Stand-ard	Designation External right Internal left	Coated	Designation Internal right External left	Coated	
mm Inch	mm Inch	mm Inch	mm Inch	mm Inch	mm Inch	mm Inch	mm Inch	Inch	Inch			CP30	CP500	CP30	CP500
3,3 0.130	2,0 0.079	9,525 0.375	14,0 0.551	0,25 0.010	0,25 0.010	1,87 0.074	0,5 0.020	2,40	-	*	14ER2.4DY	■	14NR2.4DY		■
4,1 0.161	3,2 0.126	12,7 0.500	2 0.787	0,25 0.010	0,25 0.010	2,36 0.093	1,0 0.039	3,00	-	*	20ER3.0DY	■	20NR3.0DY		
2,4 0.094	2,0 0.079	9,525 0.375	14,0 0.551	0,2 0.008	0,2 0.008	1,45 0.057	0,5 0.020	1,80	0.071	**	14ER1.8DY	■	14NR1.8DY		■
3,6 0.142	2,1 0.083	9,525 0.375	14,0 0.551	0,3 0.012	0,3 0.012	2,16 0.085	0,5 0.020	2,65	0.104	**	14ER2.65DY	■	14NR2.65DY		
4,8 0.189	3,2 0.126	12,7 0.500	2 0.787	0,3 0.012	0,3 0.012	2,97 0.117	0,65 0.026	3,55	0.140	**	20ER3.55DY	■	20NR3.55DY		

General ISO Turning

Steadyline®

MDT

Mini-Shaft™

Grooving

Parting-off

X4

Adapters
Clamping units

Accessories and
Spare parts

Workpiece
materials

General ISO Turning

LPGN

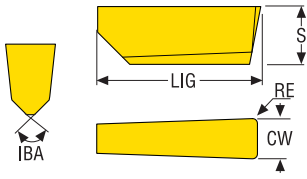

Tolerances:
CW = $\pm 0,025/0,001$
LIG = $\pm 0,04/0,0016$
S = $\pm 0,05/0,002$
RE = $\pm 0,025/0,001$

Please check availability at www.secotools.com / Seco Online Store
Tip sizes, see page(s) 134
Edge preparation, see page(s) 131

IBA = 90°

Steadyline®



MDT

Designation	RE	CW	LIG	S	Grades Coated
	mm Inch	mm Inch	mm Inch	mm Inch	CW100
LPGN120404-03175E	0,381 0.015	3,175 0.125	12,7 0.500	4,5 0.177	■
LPGN190608-0635E	0,787 0.031	6,35 0.250	19,1 0.752	6,1 0.240	■
LPGN250808-07925E	0,787 0.031	7,925 0.312	25,4 1.000	8,31 0.327	■

Mini-Shaft™

Grooving

LPGN

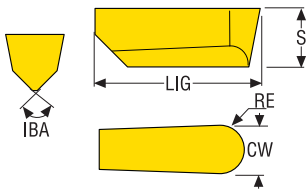

Tolerances:
CW = $\pm 0,025/0,001$
LIG = $\pm 0,04/0,0016$
S = $\pm 0,05/0,002$
RE = $\pm 0,025/0,001$

Please check availability at www.secotools.com / Seco Online Store
Tip sizes, see page(s) 134
Edge preparation, see page(s) 131

IBA = 90°

Parting-off



X4

Designation	RE	CW	LIG	S	Grades Coated
	mm Inch	mm Inch	mm Inch	mm Inch	CW100
LPGN1906M0-0635E	3,175 0.125	6,35 0.250	19,1 0.752	6,1 0.240	■

Adapters Clamping units

Accessories and Spare parts

Workpiece materials



Parting-off

Optimized for parting-off applications, the Seco 150.10 consists of a high-speed steel blade that holds the insert and a holder that retains the blade. This setup provides maximum stability, while the heat resistance of the high-speed steel ensures the insert will be securely retained especially when the blade is hot.

- Inserts in neutral version N are first choice.
- R/L-inserts have a setting angle of 6° in order to eliminate burrs.
- Three different chipbreakers, -12, -14 and -16 depending on workpiece material.

Parting-off

General ISO Turning

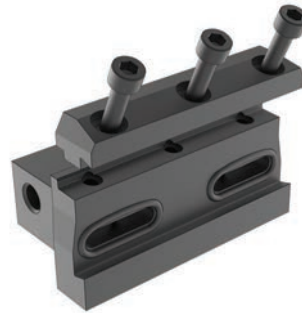
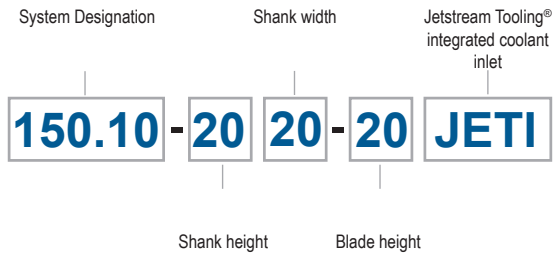

Steadyline®

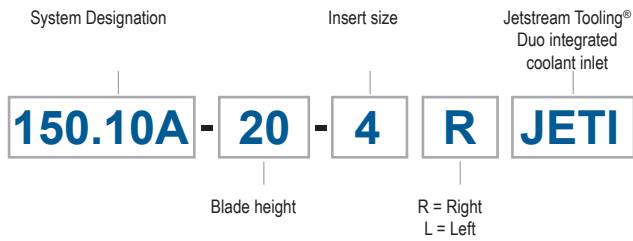

MDT

Mini-Shaft™

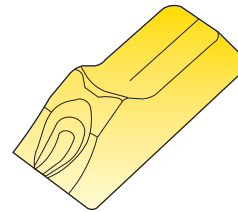
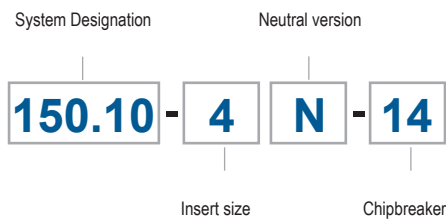

Grooving

Parting-off

For more information on Jetstream Tooling® (High pressure coolant) and accessories, please see page(s) 38, 85-89, 1002.

X4

Parting-off, up to $\varnothing 160$ mm

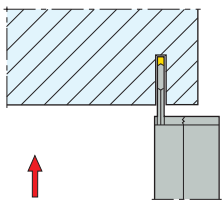

Adapters
Clamping units

Accessories and
Spare parts

Workpiece
materials

General

Use the highest blade possible (size 25) for maximum stability.

Use the shortest overhang possible for maximum stability and low risk of vibrations.

Make sure that the tool is at 90° to the centre-line of the component to ensure part quality and good tool life.

Ideally, parting-off is run with a sub-spindle or part-catcher. In this case the cutting edge will be protected by having the second spindle or a fixture picking up the workpiece.

Parting-off without sub-spindle requires the feed rate to be reduced as the tool approaches centre (by up to 75% about 2 mm before the component centre – depending on workpiece diameter). May also be applied on tubes to reduce burr.

A well-aimed and sufficient flow of coolant, ideally through the blades 150.10JETI, will give long tool life and good surface finish.

Smaller inserts reduce the material waste and thus reduce material cost. On the other hand wider inserts allow higher feed rates, which increases productivity. The optimum depends on the customer

Seco Jetstream Tooling® Duo holders, yet another innovation introduced to market, feature both a rake face and flank face jet, that may provide even better chip control and significantly longer tool life.

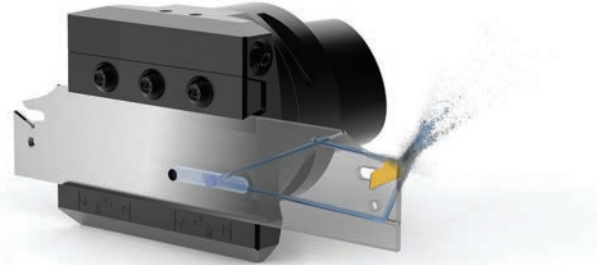

Toolholders

The Seco 150.10A parting-off system consists of a high speed steel blade which holds the insert and a holder which retains the blade. This provides maximum stability, while the hot strength of the high speed steel ensures that the insert will be securely retained even when the blade is hot.

Type 150.10...-20/25JETI basic holder

Intended for long, reversible high speed steel blades with a depth of cut of up to 160 mm diameter. The same holder is suitable for both right-hand and left-hand versions. JETI functionality with integrated coolant delivery straight to the cutting edge.

Type 150.10...-15JETI blade holder

Intended for short high speed steel blades for cutting depths up to 38 mm diameter. The high speed steel blade ensures excellent stability and, due to the compact design, is suitable for machines with limited space, such as automatic lathes. JETI functionality with integrated coolant delivery straight to the cutting edge.



Inserts

Inserts N-/ R- /L-		
<p>Inserts in neutral version N are first choice since they normally achieve increased tool life, better chip control, high surface quality and allow higher cutting data compared to the handed (R-/L-) version.</p> <p>The R-/L-inserts have a setting angle of 6° in order to eliminate burrs and minimize the parting-off pip left on the workpiece. To reduce pip size with N-inserts, use the smallest width possible. The correct centre height is another major factor to avoid pips (control to ±0.1 mm).</p> <p>When using R-/L-inserts, the feed rate should be reduced by approximately 30%.</p> <p>Convex or concave surfaces will be avoided, when using right or left hand inserts, by reducing the feed rate.</p>		
N	R	L

Chipbreakers

Chipbreakers		
<p>First choice for steel at low feed rates.</p> <p>24° positive cutting rake angle.</p> <p>Excellent chipbreaking.</p>	<p>First choice for stainless steel.</p> <p>First choice for steel at medium-high feed rates.</p> <p>15° positive cutting rake angle with sharp edge.</p>	<p>First choice for steel and cast iron in difficult conditions and/or high feed rates.</p> <p>20° positive cutting rake angle.</p> <p>Strong protection chamfer.</p>
-12	-14	-16

Recommended feed rates

Insert width CW (mm)	Chip- breaker	Radial infeed, f (mm/rev)							
		Type N insert				Type R/L insert			
		Recom. initial value	Recom. limit value			Recom. initial value	Recom. limit value		
			min	–	max		min	–	max
1,40	-12	–	–	–	–	–	–	–	–
	-14	0,05	0,04	–	0,12	–	–	–	–
	-16	0,06	0,04	–	0,12	–	–	–	–
2,0	-12	–	–	–	–	–	–	–	–
	-14	0,07	0,05	–	0,14	–	–	–	–
	-16	0,08	0,05	–	0,15	–	–	–	–
2,25	-12	–	–	–	–	–	–	–	–
	-14	0,09	0,05	–	0,16	–	–	–	–
	-16	0,10	0,05	–	0,20	–	–	–	–
2,5	-12	0,09	0,05	–	0,18	0,06	0,04	–	0,13
	-14	0,10	0,07	–	0,20	0,07	0,05	–	0,14
	-16	0,13	0,10	–	0,24	0,09	0,07	–	0,17
3,1	-12	0,10	0,05	–	0,20	0,07	0,04	–	0,14
	-14	0,13	0,08	–	0,24	0,09	0,06	–	0,17
	-16	0,18	0,12	–	0,28	0,13	0,08	–	0,20
4,1	-12	0,13	0,07	–	0,22	0,09	0,05	–	0,15
	-14	0,15	0,09	–	0,26	0,11	0,06	–	0,18
	-16	0,20	0,14	–	0,32	0,14	0,10	–	0,22
5,1	-12	0,15	0,08	–	0,26	0,11	0,06	–	0,18
	-14	0,18	0,10	–	0,34	0,13	0,07	–	0,24
	-16	0,23	0,16	–	0,40	0,16	0,11	–	0,28
6,3	-12	0,17	0,10	–	0,30	0,12	0,07	–	0,21
	-14	0,20	0,14	–	0,38	0,14	0,10	–	0,27
	-16	0,25	0,18	–	0,42	0,18	0,13	–	0,29

General ISO Turning

Steadyline®

MDT

Mini-Shaft™

Grooving

Parting-off

X4

Adapters
Clamping units

Accessories and
Spare parts

Workpiece
materials

Grades

- TGP35**
Wear-resistant **Duratomic**® CVD-coated grade intended for parting-off of steel and cast iron at high cutting speeds.
- TGP45**
Wear-resistant **Duratomic**® CVD-coated grade intended for parting-off of steel and stainless steel at moderate to high cutting speeds.
- T25M**
Tough versatile CVD-coated grade intended for parting-off of steel, stainless steel and cast iron at moderate cutting speeds.
- T350M**
Tough versatile CVD-coated grade intended for parting-off in a variety of workpiece materials at moderate cutting speeds.
- TGS2050**
Hard and wear-resistant PVD-coated micrograin grade intended for parting-off of superalloys. First choice for ISO-S materials and CoCr-alloys.
- CP500**
Tough, versatile PVD-coated micrograin grade intended for parting-off of steel, stainless steel, superalloys and titanium at low to moderate cutting speeds. First choice in stainless steel. Provides more wear resistance compared to CP600
- CP600**
Very tough PVD-coated fine-grain grade intended for parting-off of steel, stainless steel, superalloys and titanium at low cutting speeds. Well-suited in interrupted cuts. Universal choice.
- HX**
Uncoated wear-resistant hard grade intended for parting-off of hardened steels, superalloys, titanium alloys and non-ferrous materials.

Application recommendations

Easy conditions: pre-machined surface, shallow grooves etc.

Difficult conditions: raw surface, deep grooves etc.”

To centre		Tube	
Easy conditions	Difficult conditions	Easy conditions	Difficult conditions
I2 CP500	I6 CP600	I6 TGP45	I6 CP600
I4 CP500	I6 CP600	I4 CP500	I6 CP600
I2 TGP35	I6 T25M	I2 TGP35	I6 TGP45
I4 HX	I6 HX	I4 HX	I6 HX
I6 TGS2050	I4 CP600	I6 TGS2050	I6 CP600
I6 TGS2050	I6 T350M	I6 TGS2050	I6 T350M

Parting-off – Grades Secolor

The chart belows shows application areas for grades available in the Parting-off system 150.10.

The black areas in the chart indicate a grade's main ISO application groups and the white areas indicate other supplementary application groups.

Indicative ISO classification of the grades

Steel P
Stainless steel M
Cast iron K
Non-ferrous metals N
Superalloys and titanium S
Hard materials H

	P					M				K				N				S				H							
	P01	P10	P20	P30	P40	P50	M01	M10	M20	M30	M40	K01	K10	K20	K30	K40	N01	N10	N20	N30	S01	S10	S20	S30	H01	H10	H20	H30	H40
TGP35																													
TGP45																													
T25M																													
T350M																													
TGS2050																													
CP500																													
CP600																													
HX																													

Troubleshooting

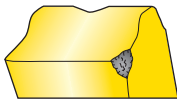
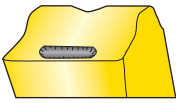
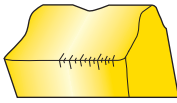
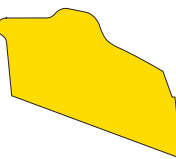
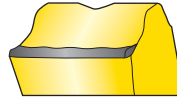
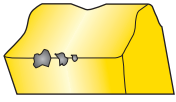
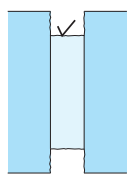
Troubleshooting			
<p>Flank wear</p> 	<p>Reduce the cutting speed. Select a more wear resistant grade.</p>	<p>Insert fracture</p> 	<p>Reduce the feed rate. Select a tougher grade. Select a stronger chipbreaker.</p>
<p>Crater wear</p> 	<p>Use a coolant. Select a more wear resistant grade. Reduce the cutting speed. Reduce the feed rate.</p>	<p>Comb cracks</p> 	<p>Reduce the cutting speed. Reduce the feed rate. Ensure that the coolant flow is adequate and constant. If not, shut off the coolant.</p>
<p>Plastic deformation</p> 	<p>Use a coolant. Select a more wear resistant grade. Reduce the cutting speed. Reduce the feed rate.</p>	<p>Built-up edge</p> 	<p>Increase the cutting speed. Increase the feed rate. Do not use coolant.</p>
<p>Edge chipping</p> 	<p>Select a tougher grade. Check the workpiece mounting. Check the cutting speed.</p>	<p>Poor finish</p> 	<p>Reduce the feed rate. Increase the cutting speed. Use a coolant. Improve the stability. Check the alignment of the tool.</p>

Change of insert	
<p>Inserts are changed with the aid of key 150.10A-150.</p> 	

General ISO Turning

Steadyline®

MDT

Mini-Shaft™

Grooving

Parting-off

X4

Adapters
Clamping units

Accessories and
Spare parts

Workpiece
materials

Cutting speed, v_c (m/min)

In this section a recommended cutting speed is indicated under specified conditions.

Use the tables beginning on page(s) 1006 to classify the workpiece material into a SMG.

The cutting data tables provide a recommendation of chipbreaker and a start value for feed rate (f) and cutting speed (v_c) for selected cutting width (CW).

The recommended cutting speeds in the tables are calculated for 15 minutes tool life with use of external flood coolant.

In order to increase the accuracy towards the actual cutting conditions and requirements of the applications the recommendation is to use

My Pages – Suggest on www.secotools.com

v_c = cutting speed (m/min)

CW = cutting width (mm)

f = feed rate (mm/rev)

Grade TGP35

SMG		CW = 2.5 CW = 0.098		CW = 3 CW = 0.118		CW = 4 CW = 0.157		CW = 5-6 CW = 0.197-0.236	
		f	v_c	f	v_c	f	v_c	f	v_c
P1	-16 TGP35	0,14	310	0,19	265	0,22	235	0,28	190
		0.0055	1025	0.0075	870	0.0085	770	0.011	620
P2	-16 TGP35	0,14	305	0,20	250	0,22	230	0,28	185
		0.0055	1000	0.0080	820	0.0085	750	0.011	610
P3	-16 TGP35	0,14	260	0,19	220	0,22	200	0,26	170
		0.0055	850	0.0075	720	0.0085	660	0.010	560
P4	-16 TGP35	0,13	235	0,18	200	0,20	185	0,26	150
		0.0050	770	0.0070	660	0.0080	610	0.010	490
P5	-16 TGP35	0,13	225	0,18	190	0,20	180	0,26	140
		0.0050	740	0.0070	620	0.0080	590	0.010	460
P6	-16 TGP35	0,13	255	0,18	215	0,20	200	0,25	165
		0.0050	840	0.0070	710	0.0080	660	0.010	540
P7	-16 TGP35	0,13	240	0,18	205	0,20	190	0,25	155
		0.0050	790	0.0070	670	0.0080	620	0.010	510
P8	-16 TGP35	0,14	220	0,19	185	0,22	165	0,26	140
		0.0055	720	0.0075	610	0.0085	540	0.010	460
P11	-16 TGP35	0,13	230	0,18	200	0,20	185	0,25	150
		0.0050	750	0.0070	660	0.0080	610	0.010	490
P12	-16 TGP35	0,090	145	0,12	140	0,14	130	0,17	120
		0.0036	475	0.0048	460	0.0055	425	0.0065	395
M1	-14 TGP35	0,10	180	0,13	160	0,15	145	0,19	120
		0.0040	590	0.0050	520	0.0060	475	0.0075	395
M2	-14 TGP35	0,090	150	0,12	135	0,13	130	0,18	100
		0.0036	490	0.0048	445	0.0050	425	0.0070	330
M3	-14 TGP35	0,075	120	0,095	110	0,11	105	0,14	90
		0.0030	395	0.0038	360	0.0044	345	0.0055	295
M4	-14 TGP35	0,065	90	0,080	85	0,095	85	0,12	75
		0.0026	295	0.0032	280	0.0038	280	0.0048	245
M5	-14 TGP35	0,065	75	0,080	75	0,095	70	0,12	65
		0.0026	245	0.0032	245	0.0038	230	0.0048	215

Grade TGP45

SMG		CW = 1.4 CW = 0.055		CW = 2.0-2.5 CW = 0.079-0.098		CW = 3 CW = 0.118		CW = 4 CW = 0.157		CW = 5-6 CW = 0.197-0.236	
		f	v _c	f	v _c	f	v _c	f	v _c	f	v _c
P1	-16 TGP45	0,080	300	0,12	290	0,19	235	0,22	210	0,28	165
		0.0032	980	0.0048	950	0.0075	770	0.0085	690	0.011	540
P2	-16 TGP45	0,080	290	0,13	275	0,20	220	0,22	205	0,28	165
		0.0032	950	0.0050	900	0.0080	720	0.0085	670	0.011	540
P3	-16 TGP45	0,075	250	0,12	245	0,19	195	0,22	175	0,26	150
		0.0030	820	0.0048	800	0.0075	640	0.0085	570	0.010	490
P4	-16 TGP45	0,075	220	0,12	215	0,18	180	0,20	165	0,26	130
		0.0030	720	0.0048	710	0.0070	590	0.0080	540	0.010	425
P5	-16 TGP45	0,075	210	0,11	210	0,18	170	0,20	160	0,26	125
		0.0030	690	0.0044	690	0.0070	560	0.0080	520	0.010	410
P6	-16 TGP45	0,070	230	0,11	235	0,18	190	0,20	175	0,25	145
		0.0028	750	0.0044	770	0.0070	620	0.0080	570	0.010	475
P7	-16 TGP45	0,070	220	0,11	220	0,18	180	0,20	165	0,25	140
		0.0028	720	0.0044	720	0.0070	590	0.0080	540	0.010	460
P8	-16 TGP45	0,075	210	0,12	205	0,19	165	0,22	145	0,26	125
		0.0030	690	0.0048	670	0.0075	540	0.0085	475	0.010	410
P11	-16 TGP45	0,070	210	0,11	215	0,18	175	0,20	160	0,25	135
		0.0028	690	0.0044	710	0.0070	570	0.0080	520	0.010	445
P12	-16 TGP45	0,050	110	0,080	130	0,12	125	0,14	115	0,17	105
		0.0020	360	0.0032	425	0.0048	410	0.0055	375	0.0065	345
M1	-14 TGP45	0,075	170	0,095	165	0,13	140	0,15	130	0,19	105
		0.0030	560	0.0038	540	0.0050	460	0.0060	425	0.0075	345
M2	-14 TGP45	0,065	140	0,085	135	0,12	120	0,13	115	0,18	90
		0.0026	460	0.0034	445	0.0048	395	0.0050	375	0.0070	295
M3	-14 TGP45	0,055	105	0,070	105	0,095	100	0,11	95	0,14	80
		0.0022	345	0.0028	345	0.0038	330	0.0044	310	0.0055	260
M4	-14 TGP45	0,046	75	0,060	80	0,080	75	0,095	75	0,12	65
		0.0018	245	0.0024	260	0.0032	245	0.0038	245	0.0048	215
M5	-14 TGP45	0,046	60	0,060	65	0,080	65	0,095	60	0,12	55
		0.0018	195	0.0024	215	0.0032	215	0.0038	195	0.0048	180

Grade TGS2050

SMG		CW = 1.4 CW = 0.055		CW = 2.0-2.5 CW = 0.079-0.098		CW = 3 CW = 0.118		CW = 4 CW = 0.157	
		f	v _c	f	v _c	f	v _c	f	v _c
M1	-14 TGS2050	0,075	200	0,095	195	0,13	170	0,15	155
		0.0030	660	0.0038	640	0.0050	560	0.0060	510
M2	-14 TGS2050	0,065	160	0,085	160	0,12	145	0,13	135
		0.0026	520	0.0034	520	0.0048	475	0.0050	445
M3	-14 TGS2050	0,055	115	0,070	125	0,095	120	0,11	115
		0.0022	375	0.0028	410	0.0038	395	0.0044	375
M4	-14 TGS2050	0,046	80	0,060	90	0,080	90	0,095	90
		0.0018	260	0.0024	295	0.0032	295	0.0038	295
M5	-14 TGS2050	0,046	70	0,060	75	0,080	75	0,095	75
		0.0018	230	0.0024	245	0.0032	245	0.0038	245
S1	-16 TGS2050	0,050	36	0,080	31	0,13	27	0,14	26
		0.0020	120	0.0032	100	0.0050	90	0.0055	85
S2	-16 TGS2050	0,046	29	0,060	27	0,080	25	0,095	24
		0.0018	95	0.0024	90	0.0032	80	0.0038	80
S3	-16 TGS2050	0,044	26	0,055	24	0,075	22	0,085	21
		0.0017	85	0.0022	80	0.0030	70	0.0034	70
S11	-16 TGS2050	0,055	50	0,070	47	0,095	43	0,11	41
		0.0022	165	0.0028	155	0.0038	140	0.0044	135
S12	-16 TGS2050	0,055	39	0,070	36	0,095	33	0,11	31
		0.0022	130	0.0028	120	0.0038	110	0.0044	100
S13	-16 TGS2050	0,046	31	0,060	29	0,080	27	0,095	25
		0.0018	100	0.0024	95	0.0032	90	0.0038	80

Grade T25M

SMG		CW = 2.25-2.5 CW = 0.089-0.098		CW = 3 CW = 0.118		CW = 4 CW = 0.157		CW = 5-6 CW = 0.197-0.236	
		f	v _c	f	v _c	f	v _c	f	v _c
P1	-16 T25M	0,14	250	0,19	210	0,22	190	0,28	150
		0.0055	820	0.0075	690	0.0085	620	0.011	490
P2	-16 T25M	0,14	245	0,20	200	0,22	185	0,28	145
		0.0055	800	0.0080	660	0.0085	610	0.011	475
P3	-16 T25M	0,14	210	0,19	175	0,22	160	0,26	135
		0.0055	690	0.0075	570	0.0085	520	0.010	445
P4	-16 T25M	0,13	190	0,18	160	0,20	150	0,26	120
		0.0050	620	0.0070	520	0.0080	490	0.010	395
P5	-16 T25M	0,13	180	0,18	155	0,20	140	0,26	115
		0.0050	590	0.0070	510	0.0080	460	0.010	375
P6	-16 T25M	0,13	200	0,18	170	0,20	160	0,25	130
		0.0050	660	0.0070	560	0.0080	520	0.010	425
P7	-16 T25M	0,13	190	0,18	165	0,20	150	0,25	125
		0.0050	620	0.0070	540	0.0080	490	0.010	410
P8	-16 T25M	0,14	175	0,19	150	0,22	135	0,26	115
		0.0055	570	0.0075	490	0.0085	445	0.010	375
P11	-16 T25M	0,13	185	0,18	160	0,20	145	0,25	120
		0.0050	610	0.0070	520	0.0080	475	0.010	395
P12	-16 T25M	0,090	115	0,12	110	0,14	105	0,17	95
		0.0036	375	0.0048	360	0.0055	345	0.0065	310
M1	-14 T25M	0,10	145	0,13	125	0,15	115	0,19	95
		0.0040	475	0.0050	410	0.0060	375	0.0075	310
M2	-14 T25M	0,090	120	0,12	105	0,13	100	0,18	80
		0.0036	395	0.0048	345	0.0050	330	0.0070	260
M3	-14 T25M	0,075	95	0,095	90	0,11	85	0,14	75
		0.0030	310	0.0038	295	0.0044	280	0.0055	245
M4	-14 T25M	0,065	70	0,080	70	0,095	65	0,12	60
		0.0026	230	0.0032	230	0.0038	215	0.0048	195
M5	-14 T25M	0,065	60	0,080	60	0,095	55	0,12	50
		0.0026	195	0.0032	195	0.0038	180	0.0048	165

Grade T350M

SMG		CW = 2.0-2.25 CW = 0.079-0.089		CW = 2.5 CW = 0.098		CW = 3 CW = 0.118		CW = 4 CW = 0.157	
		f	v _c	f	v _c	f	v _c	f	v _c
P1	-16 T350M	0,12	245	0,14	230	0,19	195	0,22	175
		0.0048	800	0.0055	750	0.0075	640	0.0085	570
P2	-16 T350M	0,13	230	0,14	225	0,20	185	0,22	170
		0.0050	750	0.0055	740	0.0080	610	0.0085	560
P3	-16 T350M	0,12	205	0,14	195	0,19	165	0,22	145
		0.0048	670	0.0055	640	0.0075	540	0.0085	475
P4	-16 T350M	0,12	180	0,13	175	0,18	150	0,20	140
		0.0048	590	0.0050	570	0.0070	490	0.0080	460
P5	-16 T350M	0,11	175	0,13	165	0,18	145	0,20	130
		0.0044	570	0.0050	540	0.0070	475	0.0080	425
P6	-16 T350M	0,11	195	0,13	190	0,18	160	0,20	150
		0.0044	640	0.0050	620	0.0070	520	0.0080	490
P7	-16 T350M	0,11	185	0,13	175	0,18	150	0,20	140
		0.0044	610	0.0050	570	0.0070	490	0.0080	460
P8	-16 T350M	0,12	170	0,14	165	0,19	140	0,22	125
		0.0048	560	0.0055	540	0.0075	460	0.0085	410
P11	-16 T350M	0,11	180	0,13	170	0,18	145	0,20	135
		0.0044	590	0.0050	560	0.0070	475	0.0080	445
P12	-16 T350M	0,080	110	0,090	110	0,12	105	0,14	95
		0.0032	360	0.0036	360	0.0048	345	0.0055	310
M1	-14 T350M	0,095	135	0,10	135	0,13	120	0,15	110
		0.0038	445	0.0040	445	0.0050	395	0.0060	360
M2	-14 T350M	0,085	115	0,090	110	0,12	100	0,13	95
		0.0034	375	0.0036	360	0.0048	330	0.0050	310
M3	-14 T350M	0,070	90	0,075	90	0,095	85	0,11	80
		0.0028	295	0.0030	295	0.0038	280	0.0044	260
M4	-14 T350M	0,060	65	0,065	65	0,080	65	0,095	60
		0.0024	215	0.0026	215	0.0032	215	0.0038	195
M5	-14 T350M	0,060	55	0,065	55	0,080	55	0,095	50
		0.0024	180	0.0026	180	0.0032	180	0.0038	165

General ISO Turning
Steadyline®
MDT
Mini-Shaft™
Grooving
Parting-off
X4
Adapters Clamping units
Accessories and Spare parts
Workpiece materials

Grade CP500

SMG		CW = 1.4 CW = 0.055		CW = 2.0-2.5 CW = 0.079-0.098		CW = 3 CW = 0.118		CW = 4 CW = 0.157		CW = 5-6 CW = 0.197-0.236	
		f	v _c	f	v _c	f	v _c	f	v _c	f	v _c
P1	-16 CP500	0,080	205	0,12	180	0,19	150	0,22	140	0,28	125
		0.0032	670	0.0048	590	0.0075	490	0.0085	460	0.011	410
P2	-16 CP500	0,080	200	0,13	170	0,20	145	0,22	140	0,28	125
		0.0032	660	0.0050	560	0.0080	475	0.0085	460	0.011	410
P3	-16 CP500	0,075	175	0,12	150	0,19	125	0,22	120	0,26	110
		0.0030	570	0.0048	490	0.0075	410	0.0085	395	0.010	360
P4	-16 CP500	0,075	155	0,12	130	0,18	115	0,20	110	0,26	95
		0.0030	510	0.0048	425	0.0070	375	0.0080	360	0.010	310
P5	-16 CP500	0,075	145	0,11	130	0,18	110	0,20	105	0,26	90
		0.0030	475	0.0044	425	0.0070	360	0.0080	345	0.010	295
P6	-16 CP500	0,070	170	0,11	145	0,18	120	0,20	115	0,25	105
		0.0028	560	0.0044	475	0.0070	395	0.0080	375	0.010	345
P7	-16 CP500	0,070	160	0,11	140	0,18	115	0,20	110	0,25	100
		0.0028	520	0.0044	460	0.0070	375	0.0080	360	0.010	330
P8	-16 CP500	0,075	145	0,12	125	0,19	105	0,22	100	0,26	90
		0.0030	475	0.0048	410	0.0075	345	0.0085	330	0.010	295
P11	-16 CP500	0,070	155	0,11	135	0,18	110	0,20	105	0,25	95
		0.0028	510	0.0044	445	0.0070	360	0.0080	345	0.010	310
P12	-16 CP500	0,050	100	0,080	85	0,12	75	0,14	70	0,17	65
		0.0020	330	0.0032	280	0.0048	245	0.0055	230	0.0065	215
M1	-14 CP500	0,075	235	0,095	225	0,13	190	0,15	175	0,19	145
		0.0030	770	0.0038	740	0.0050	620	0.0060	570	0.0075	475
M2	-14 CP500	0,065	190	0,085	185	0,12	160	0,13	155	0,18	120
		0.0026	620	0.0034	610	0.0048	520	0.0050	510	0.0070	395
M3	-14 CP500	0,055	145	0,070	145	0,095	135	0,11	130	0,14	110
		0.0022	475	0.0028	475	0.0038	445	0.0044	425	0.0055	360
M4	-14 CP500	0,046	105	0,060	110	0,080	105	0,095	100	0,12	90
		0.0018	345	0.0024	360	0.0032	345	0.0038	330	0.0048	295
M5	-14 CP500	0,046	90	0,060	90	0,080	90	0,095	85	0,12	75
		0.0018	295	0.0024	295	0.0032	295	0.0038	280	0.0048	245
K1	-16 CP500	0,080	190	0,13	165	0,20	140	0,22	135	0,28	125
		0.0032	620	0.0050	540	0.0080	460	0.0085	445	0.011	410
K2	-16 CP500	0,075	165	0,11	140	0,18	115	0,20	105	0,26	90
		0.0030	540	0.0044	460	0.0070	375	0.0080	345	0.010	295
K3	-16 CP500	0,075	140	0,11	120	0,18	95	0,20	90	0,26	80
		0.0030	460	0.0044	395	0.0070	310	0.0080	295	0.010	260
K4	-16 CP500	0,075	130	0,11	115	0,18	90	0,20	85	0,26	75
		0.0030	425	0.0044	375	0.0070	295	0.0080	280	0.010	245
K5	-16 CP500	0,065	80	0,10	70	0,16	55	0,18	55	0,22	48
		0.0026	260	0.0040	230	0.0065	180	0.0070	180	0.0085	155
K6	-16 CP500	0,075	120	0,11	105	0,18	90	0,20	85	0,26	80
		0.0030	395	0.0044	345	0.0070	295	0.0080	280	0.010	260
K7	-16 CP500	0,065	105	0,10	90	0,16	75	0,18	70	0,22	60
		0.0026	345	0.0040	295	0.0065	245	0.0070	230	0.0085	195
N11	-14 CP500	0,095	125	0,12	115	0,16	105	0,19	95	0,25	85
		0.0038	410	0.0048	375	0.0065	345	0.0075	310	0.010	280
S1	-14 CP500	0,046	26	0,060	24	0,080	22	0,095	21	0,12	19
		0.0018	85	0.0024	80	0.0032	70	0.0038	70	0.0048	60
S2	-14 CP500	0,046	22	0,060	21	0,080	19	0,095	18	0,12	17
		0.0018	70	0.0024	70	0.0032	60	0.0038	60	0.0048	55
S3	-14 CP500	0,044	20	0,055	18	0,075	17	0,085	16	0,12	14
		0.0017	65	0.0022	60	0.0030	55	0.0034	50	0.0048	46

Grade CP600

SMG		CW = 1.4 CW = 0.055		CW = 2.0-2.5 CW = 0.079-0.098		CW = 3 CW = 0.118		CW = 4 CW = 0.157		CW = 5-6 CW = 0.197-0.236	
		f	v _c	f	v _c	f	v _c	f	v _c	f	v _c
M1	-14 CP600	0,075	240	0,095	220	0,13	180	0,16	150	0,19	130
		0.0030	790	0.0038	720	0.0050	590	0.0065	490	0.0075	425
M2	-14 CP600	0,065	200	0,085	185	0,12	155	0,15	130	0,18	110
		0.0026	660	0.0034	610	0.0048	510	0.0060	425	0.0070	360
M3	-14 CP600	0,055	155	0,070	150	0,095	135	0,12	115	0,14	105
		0.0022	510	0.0028	490	0.0038	445	0.0048	375	0.0055	345
M4	-14 CP600	0,046	110	0,060	115	0,085	105	0,10	95	0,12	85
		0.0018	360	0.0024	375	0.0034	345	0.0040	310	0.0048	280
M5	-14 CP600	0,046	95	0,060	95	0,085	90	0,10	80	0,12	70
		0.0018	310	0.0024	310	0.0034	295	0.0040	260	0.0048	230

Grade HX

SMG		CW = 1.4 CW = 0.055		CW = 2.0-2.5 CW = 0.079-0.098		CW = 3 CW = 0.118		CW = 4 CW = 0.157		CW = 5-6 CW = 0.197-0.236	
		f	V _c	f	V _c	f	V _c	f	V _c	f	V _c
M1	-14 HX	0,075	140	0,095	125	0,13	115	0,15	110	0,19	100
		0.0030	460	0.0038	410	0.0050	375	0.0060	360	0.0075	330
M2	-14 HX	0,065	115	0,085	105	0,12	95	0,13	90	0,18	80
		0.0026	375	0.0034	345	0.0048	310	0.0050	295	0.0070	260
M3	-14 HX	0,055	90	0,070	85	0,095	75	0,11	75	0,14	65
		0.0022	295	0.0028	280	0.0038	245	0.0044	245	0.0055	215
M4	-14 HX	0,046	70	0,060	65	0,080	60	0,095	60	0,12	55
		0.0018	230	0.0024	215	0.0032	195	0.0038	195	0.0048	180
M5	-14 HX	0,046	60	0,060	55	0,080	50	0,095	48	0,12	44
		0.0018	195	0.0024	180	0.0032	165	0.0038	155	0.0048	145
K1	-16 HX	0,080	140	0,13	115	0,20	100	0,22	95	0,28	85
		0.0032	460	0.0050	375	0.0080	330	0.0085	310	0.011	280
K2	-16 HX	0,075	120	0,11	105	0,18	90	0,20	85	0,26	75
		0.0030	395	0.0044	345	0.0070	295	0.0080	280	0.010	245
K3	-16 HX	0,075	105	0,11	90	0,18	75	0,20	70	0,26	65
		0.0030	345	0.0044	295	0.0070	245	0.0080	230	0.010	215
K4	-16 HX	0,075	100	0,11	85	0,18	70	0,20	70	0,26	60
		0.0030	330	0.0044	280	0.0070	230	0.0080	230	0.010	195
K5	-16 HX	0,065	60	0,10	55	0,16	45	0,18	43	0,22	39
		0.0026	195	0.0040	180	0.0065	150	0.0070	140	0.0085	130
K6	-16 HX	0,075	85	0,11	75	0,18	65	0,20	60	0,26	55
		0.0030	280	0.0044	245	0.0070	215	0.0080	195	0.010	180
K7	-16 HX	0,065	75	0,10	70	0,16	55	0,18	55	0,22	50
		0.0026	245	0.0040	230	0.0065	180	0.0070	180	0.0085	165
N1	-14 HX	0,095	410	0,12	380	0,16	340	0,19	315	0,25	280
		0.0038	1350	0.0048	1250	0.0065	1125	0.0075	1025	0.010	920
N2	-14 HX	0,095	330	0,12	305	0,16	275	0,19	255	0,25	225
		0.0038	1075	0.0048	1000	0.0065	900	0.0075	840	0.010	740
N3	-14 HX	0,095	220	0,12	205	0,16	180	0,19	170	0,25	150
		0.0038	720	0.0048	670	0.0065	590	0.0075	560	0.010	490
N11	-14 HX	0,095	255	0,12	230	0,16	210	0,19	195	0,25	170
		0.0038	840	0.0048	750	0.0065	690	0.0075	640	0.010	560
S1	-14 HX	0,046	27	0,060	25	0,080	23	0,095	22	0,12	20
		0.0018	90	0.0024	80	0.0032	75	0.0038	70	0.0048	65
S2	-14 HX	0,046	22	0,060	20	0,080	19	0,095	18	0,12	16
		0.0018	70	0.0024	65	0.0032	60	0.0038	60	0.0048	50
S3	-14 HX	0,044	19	0,055	18	0,075	16	0,085	16	0,12	14
		0.0017	60	0.0022	60	0.0030	50	0.0034	50	0.0048	46
S11	-14 HX	0,055	38	0,070	35	0,095	32	0,11	30	0,14	28
		0.0022	125	0.0028	115	0.0038	105	0.0044	100	0.0055	90
S12	-14 HX	0,055	29	0,070	27	0,095	25	0,11	23	0,14	21
		0.0022	95	0.0028	90	0.0038	80	0.0044	75	0.0055	70
S13	-14 HX	0,046	23	0,060	22	0,080	20	0,095	19	0,12	18
		0.0018	75	0.0024	70	0.0032	65	0.0038	60	0.0048	60
H5	-16 HX	0,050	45	0,080	40	0,12	35	0,14	33	0,17	30
		0.0020	150	0.0032	130	0.0048	115	0.0055	110	0.0065	100

General ISO Turning

Steadyline®

MDT

Mini-Shaft™

Grooving

Parting-off

X4

Adapters
Clamping units

Accessories and
Spare parts

Workpiece
materials

General ISO Turning

HSS-blade 150.10A-15 JETI for Parting-off – Metric/ Inch

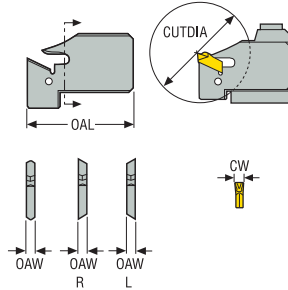

R/L150.10
KAPR = 90,0 °

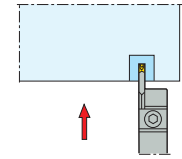

Steadyline®

MDT

- For inserts program, see page(s) 936, 937
- For more information on Jetstream Tooling® (High pressure coolant) and accessories, please see page(s) 38, 85-89, 1002
- * Max coolant pressure may need additional spare part according to machine side limitation
- Right-hand version shown
- For Jetstream function Right-hand blade must only be used with Right-hand toolblock
- For Jetstream function Left-hand blade must only be used with Left-hand toolblock
- Please check availability at www.secotools.com / Seco Online Store

Mini-Shaft™

Designation	Item number	OAL	OAW	CUTDIA	CP*	Weight	CW	CTWS
		mm Inch	mm Inch	mm Inch	bar psi	kg lbs	mm Inch	
150.10A-15-2RJETI	02885702	33 1.303	1,8 0.071	38,0 1.496	200 2901.0	0,1 0.220	2,0 0.079	150.10-2
150.10A-15-2LJETI	02885696	33 1.303	1,8 0.071	38,0 1.496	200 2901.0	0,1 0.220	2,0 0.079	150.10-2
150.10A-15-2.5RJETI	02885690	33 1.303	2,0 0.079	38,0 1.496	200 2901.0	0,1 0.220	2,5 0.098	150.10-2.5
150.10A-15-2.5LJETI	02884781	33 1.303	2,0 0.079	38,0 1.496	200 2901.0	0,1 0.220	2,5 0.098	150.10-2.5
150.10A-15-3RJETI	02885689	33 1.303	2,4 0.094	38,0 1.496	200 2901.0	0,1 0.220	3,0 0.118	150.10-3
150.10A-15-3LJETI	02884780	33 1.303	2,4 0.094	38,0 1.496	200 2901.0	0,1 0.220	3,0 0.118	150.10-3
R150.10A-15-4JETI	02885688	33 1.303	3,4 0.134	38,0 1.496	200 2901.0	0,1 0.220	4,0 0.157	150.10-4
L150.10A-15-4JETI	02884779	33 1.303	3,4 0.134	38,0 1.496	200 2901.0	0,1 0.220	4,0 0.157	150.10-4

Grooving

Parting-off

X4

Accessories

Adapters
Clamping units

For size	Key
150.10A-..	150.10A-150
R/L150.10A-..	150.10A-150

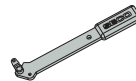

Accessories and
Spare parts

Workpiece
materials

Toolblock R/L150.10-..15 JETI for HSS-blade 150.10A-..15JETI for Parting-off – Metric

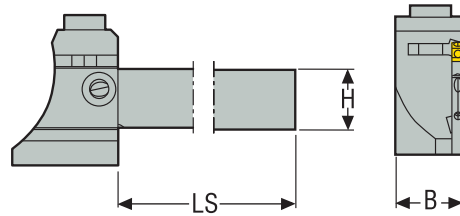
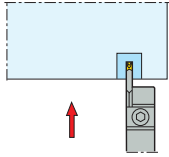

R/L150.10
KAPR



- For blades program, see page(s) 920
- For more information on Jetstream Tooling® (High pressure coolant) and accessories, please see page(s) 38, 85-89, 1002
- * Max coolant pressure may need additional spare part according to machine side limitation
- Right-hand version shown
- Right-hand blade must only be used with Right-hand toolblock
- Left-hand blade must only be used with Left-hand toolblock
- Please check availability at www.secotools.com / Seco Online Store

Designation	Item number	H	B	LS	CP*	Weight
		mm	mm	mm	bar	kg
R150.10-1010-15JETI	03002477	10	10	136	200	0,2
R150.10-1212-15JETI	03002478	12	12	136	200	0,2
R150.10-1616-15JETI	03002479	16	16	81	200	0,3
L150.10-1010-15JETI	03002482	10	10	136	200	0,2
L150.10-1212-15JETI	03002483	12	12	136	200	0,2
L150.10-1616-15JETI	03002484	16	16	81	200	0,2

Spare Parts

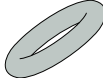
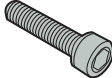
For size	Key	Plug	Ring	Screw
R/L150.10-..	 4SMS795	 P6SS6X5G	 ORING-4X1.5	 MC6S5X18

General / ISO Turning

Steadyline®

MDT

Mini-Shaft™

Grooving

Parting-off

X4

Adapters
Clamping units

Accessories and
Spare parts

Workpiece
materials

General ISO Turning

Steadyline®

MDT

Mini-Shaft™

Grooving

Parting-off

X4

Adapters
Clamping units

Accessories and
Spare parts

Workpiece
materials

Toolblock R/L150.10-..15 JETI for HSS-blade 150.10A-..15JETI for Parting-off – Inch

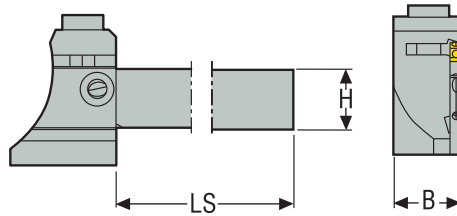

R/L150.10
KAPR

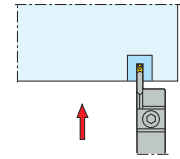

- For blades program, see page(s) 920
- For more information on Jetstream Tooling® (High pressure coolant) and accessories, please see page(s) 38, 85-89, 1002
- * Max coolant pressure may need additional spare part according to machine side limitation
- Right-hand version shown
- Right-hand blade must only be used with Right-hand toolblock
- Left-hand blade must only be used with Left-hand toolblock
- Please check availability at www.secotools.com / Seco Online Store

Designation	Item number	H	B	LS	CP*	Weight
		Inch	Inch	Inch	psi	lbs
R150.10-0500-15JETI	03128625	0.500	0.500	3.150	2901.0	0.440
R150.10-0625-15JETI	03128627	0.625	0.625	3.150	2901.0	0.660
R150.10-0750-15JETI	03128629	0.750	0.750	3.150	2901.0	2.650
R150.10-1000-15JETI	03128631	1.000	1.000	4.646	2901.0	0.660
L150.10-0500-15JETI	03128626	0.500	0.500	3.150	2901.0	0.440
L150.10-0625-15JETI	03128628	0.625	0.625	3.150	2901.0	0.660
L150.10-0750-15JETI	03128630	0.750	0.750	3.150	2901.0	0.880
L150.10-1000-15JETI	03128632	1.000	1.000	4.646	2901.0	2.650

Spare Parts

For size	Clamp key	Plug	Ring	Screw
...-0500/0625	3/16SMS875	P6SS6X5G	ORING-4X1.5	UC6S1/4UNFX1
...-0750/1000	3/16SMS875	JET-P1/8-5MM	ORING-4X1.5	UC6S1/4UNFX1

Toolblock R/L150.10-..15JETI for HSS-blade 150.10A..15JETI for Parting-off, compatible with JETI adapters – Metric

KAPR

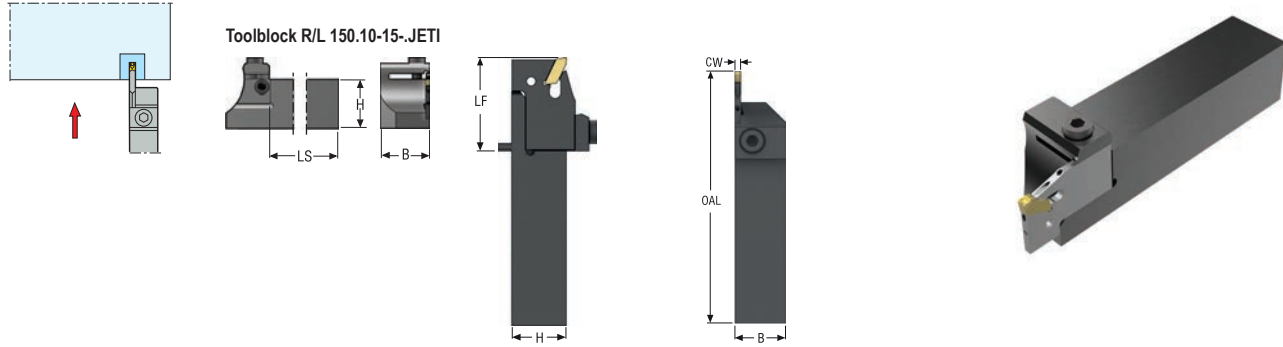

- For blades program, see page(s) 920
- For suitable adapter, see page(s) 962-973
- For more information on Jetstream Tooling® (High pressure coolant) and accessories, please see page(s) 38, 85-89, 1002
- * Max coolant pressure may need additional spare part according to machine side limitation
- Right-hand version shown
- Right-hand blade must only be used with Right-hand toolblock
- Left-hand blade must only be used with Left-hand toolblock
- Please check availability at www.secotools.com / Seco Online Store

Designation	Item number	H	B	LS	OAL	LF	CP*	Weight
		mm	mm	mm	mm	mm	bar	kg
R150.10-2020X-15JETI	03245886	20	20	64	98	34	200	0,1
R150.10-2525X-15JETI	03245888	25	25	84	118	34	200	0,1
L150.10-2020X-15JETI	03245885	20	20	64	98	34	200	0,4
L150.10-2525X-15JETI	03245887	25	25	84	118	34	200	0,6

Spare Parts

For size	Clamp key	Clamp screw	O-ring	Plug	Plug screw
R/L150.10-..X	4SMS795	MC6S5X18	ORING-4X1.5	JET-P1/8-5MM	P6SS6X6

General ISO Turning

Steadyline®

MDT

Mini-Shaft™

Grooving

Parting-off

X4

Adapters Clamping units

Accessories and Spare parts

Workpiece materials

General ISO Turning

HSS-blade 150.10A-20/25 JETI for Parting-off – Metric/ Inch

Steadyline®

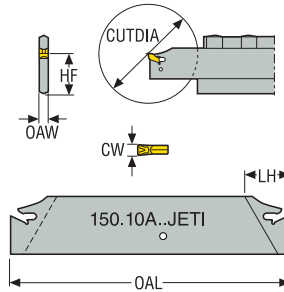

MDT

- For inserts program, see page(s) 936, 937
- For more information on Jetstream Tooling® (High pressure coolant) and accessories, please see page(s) 38, 85-89, 1002
- * Max coolant pressure may need additional spare part according to machine side limitation
- Right-hand version of blade shown
- Please check availability at www.secotools.com / Seco Online Store

Mini-Shaft™

Designation	Item number	OAL	OAW	HF	LH	CUTDIA	CP*	Weight	CW	CTWS
		mm Inch	mm Inch	mm Inch	mm Inch	mm Inch	bar psi	kg lbs	mm Inch	
150.10A-20-2RJETI	03002649	120 4.724	1,8 0.071	21,4 0.843	24,0 0.945	35,0 1.378	200 2901.0	0,1 0.220	2,0 0.079	150.10-2
150.10A-20-2.5RJETI	03002651	120 4.724	2,0 0.079	21,4 0.843	24,0 0.945	35,0 1.378	200 2901.0	0,1 0.220	2,5 0.098	150.10-2.5
150.10A-20-3RJETI	03002653	120 4.724	2,4 0.094	21,4 0.843	-	92,0 3.622	200 2901.0	0,1 0.220	3,0 0.118	150.10-3
150.10A-20-4RJETI	03002655	120 4.724	3,4 0.134	21,4 0.843	-	98,0 3.858	200 2901.0	0,1 0.220	4,0 0.157	150.10-4
150.10A-20-5RJETI	03002657	120 4.724	4,4 0.173	21,4 0.843	-	98,0 3.858	200 2901.0	0,1 0.220	5,0 0.197	150.10-5
150.10A-20-6RJETI	03002659	120 4.724	5,7 0.222	21,4 0.843	-	98,0 3.858	200 2901.0	0,2 0.440	6,0 0.236	150.10-6
150.10A-20-2LJETI	03002650	120 4.724	1,8 0.071	21,4 0.843	24,0 0.945	35,0 1.378	200 2901.0	0,1 0.220	2,0 0.079	150.10-2
150.10A-20-2.5LJETI	03002652	120 4.724	2,0 0.079	21,4 0.843	24,0 0.945	35,0 1.378	200 2901.0	0,1 0.220	2,5 0.098	150.10-2.5
150.10A-20-3LJETI	03002654	120 4.724	2,4 0.094	21,4 0.843	-	98,0 3.858	200 2901.0	0,1 0.220	3,0 0.118	150.10-3
150.10A-20-4LJETI	03002656	120 4.724	3,4 0.134	21,4 0.843	-	98,0 3.858	200 2901.0	0,1 0.220	4,0 0.157	150.10-4
150.10A-20-5LJETI	03002658	120 4.724	4,4 0.173	21,4 0.843	-	98,0 3.858	200 2901.0	0,1 0.220	5,0 0.197	150.10-5
150.10A-20-6LJETI	03002660	120 4.724	5,7 0.222	21,4 0.843	-	98,0 3.858	200 2901.0	0,2 0.440	6,0 0.236	150.10-6
150.10A-25-2RJETI	03002661	150 5.906	1,8 0.071	25,0 0.984	25,0 0.984	35,0 1.378	200 2901.0	0,08 0.180	2,0 0.079	150.10-2
150.10A-25-2.5RJETI	03002663	150 5.906	2,0 0.079	25,0 0.984	25,0 0.984	35,0 1.378	200 2901.0	0,1 0.220	2,5 0.098	150.10-2.5
150.10A-25-3RJETI	03002665	150 5.906	2,4 0.094	24,96 0.983	25,0 0.984	122,0 4.803	200 2901.0	0,08 0.180	3,0 0.118	150.10-3
150.10A-25-4RJETI	03002667	150 5.906	3,4 0.134	25,0 0.984	25,0 0.984	122,0 4.803	200 2901.0	0,1 0.220	4,0 0.157	150.10-4
150.10A-25-5RJETI	03002669	150 5.906	4,4 0.173	25,0 0.984	-	122,0 4.803	200 2901.0	0,2 0.440	5,0 0.197	150.10-5
150.10A-25-6RJETI	03002671	150 5.906	5,7 0.222	25,0 0.984	-	122,0 4.803	200 2901.0	0,2 0.440	6,0 0.236	150.10-6
150.10A-25-2LJETI	03002662	150 5.906	1,8 0.071	25,0 0.984	25,0 0.984	35,0 1.378	200 2901.0	0,08 0.180	2,0 0.079	150.10-2

Designation	Item number	OAL	OAW	HF	LH	CUTDIA	CP*	Weight	CW	CTWS
		mm Inch	mm Inch	mm Inch	mm Inch	mm Inch	bar psi	kg lbs	mm Inch	
150.10A-25-2.5LJETI	03002664	150 5.906	2,0 0.079	25,0 0.984	25,0 0.984	35,0 1.378	200 2901.0	0,1 0.220	2,5 0.098	150.10-2.5
150.10A-25-3LJETI	03002666	150 5.906	2,4 0.094	24,96 0.983	25,0 0.984	122,0 4.803	200 2901.0	0,08 0.180	3,0 0.118	150.10-3
150.10A-25-4LJETI	03002668	150 5.906	3,4 0.134	25,0 0.984	25,0 0.984	122,0 4.803	200 2901.0	0,1 0.220	4,0 0.157	150.10-4
150.10A-25-5LJETI	03002670	150 5.906	4,4 0.173	25,0 0.984	-	122,0 4.803	200 2901.0	0,2 0.440	5,0 0.197	150.10-5
150.10A-25-6LJETI	03002672	150 5.906	5,7 0.222	25,0 0.984	-	122,0 4.803	200 2901.0	0,2 0.440	6,0 0.236	150.10-6

Accessories

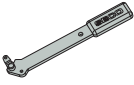
For size	Key
	
150.10A-...	150.10A-150

General ISO Turning

Steadyline®

MDT

Mini-Shaft™

Grooving

Parting-off

X4

Adapters
Clamping units

Accessories and
Spare parts

Workpiece
materials

General ISO Turning

Steadyline®

MDT

Mini-Shaft™

Grooving

Parting-off

X4

Adapters
Clamping units

Accessories and
Spare parts

Workpiece
materials

Toolblock R/L150.10-..20/25JETI for HSS-blade 150.10A-..20/25JETI for Parting-off – Metric

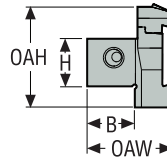
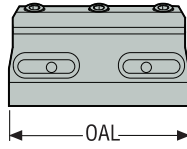

- For blades program, see page(s) 924, 925
- For more information on Jetstream Tooling® (High pressure coolant) and accessories, please see page(s) 38, 85-89, 1002
- * Max coolant pressure may need additional spare part according to machine side limitation
- Please check availability at www.secotools.com / Seco Online Store

Designation	Item number	H	B	OAH	OAL	OAW	CP*	Weight	CTWS
		mm	mm	mm	mm	mm	bar	kg	
150.10-1616-20JETI	03191913	16,0	16,0	32,0	95	35,9	200	0,6	Blade-20
150.10-2020-20JETI	03002495	20,0	20,0	32,0	95	39,8	200	0,7	Blade-20
150.10-2020-25JETI	03002498	20,0	20,0	39,0	95	40,8	200	0,8	Blade-25
150.10-2520-25JETI	03191914	25,0	20,0	42,0	95	39,8	200	0,9	Blade-25
150.10-2525-25JETI	03002500	25,0	25,0	42,0	95	44,8	200	1,0	Blade-25
150.10-3232-25JETI	03002502	32,0	32,0	49,0	95	51,8	200	1,4	Blade-25

Spare Parts

For size	Clamp	Key	O-ring	Plug	Screw
150.10-..	 150.10-260	 5SMS795	 ORING-20X2	 JET-P1/8-5MM	 TCEI0620



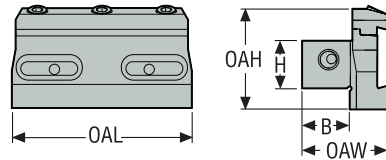

Toolblock R/L150.10-..20/25JETI for HSS-blade 150.10A-..20/25JETI for Parting-off – Inch

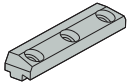

- For blades program, see page(s) 924, 925
- For more information on Jetstream Tooling® (High pressure coolant) and accessories, please see page(s) 38, 85-89, 1002
- * Max coolant pressure may need additional spare part according to machine side limitation
- Please check availability at www.secotools.com / Seco Online Store

Designation	Item number	H	B	OAH	OAL	OAW	CP*	Weight	CTWS
		Inch	Inch	Inch	Inch	Inch	psi	lbs	
150.10-10-20JETI	10005704	0.625	0.625	1.260	3.740	1.409	2901.0	1.320	Blade-20
150.10-12-20JETI	03002496	0.750	0.750	1.260	3.740	1.528	2901.0	1.540	Blade-20
150.10-12-25JETI	03002499	0.750	0.750	1.535	3.740	1.567	2901.0	1.760	Blade-25
150.10-16-20JETI	10005705	1.000	1.000	1.417	3.740	1.772	2901.0	2.200	Blade-20
150.10-16-25JETI	03002501	1.000	1.000	1.654	3.740	1.780	2901.0	2.200	Blade-25
150.10-20-25JETI	03002503	1.250	1.250	1.929	3.740	2.031	2901.0	3.090	Blade-25

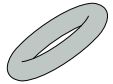
Spare Parts

For size	Clamp	Key	O-ring	Plug	Screw
150.10-..	 150.10-260	 5SMS795	 ORING-20X2	 JET-P1/8-5MM	 TCEI0620

General ISO Turning

Steadyline®

MDT

Mini-Shaft™

Grooving

Parting-off

X4

Adapters
Clamping units

Accessories and
Spare parts

Workpiece
materials

General ISO Turning

HSS-blade 150.10A-15 for Parting-off – Metric/ Inch

Steadyline®



HSS-blade 150.10A-15

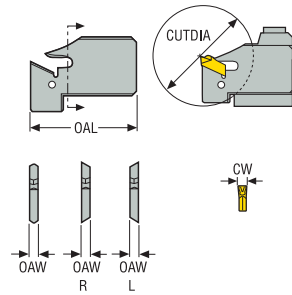

R/L 150.10
KAPR = 90,0 °

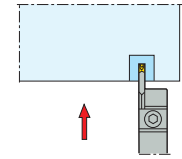

MDT

- For inserts program, see page(s) 936, 937
- Right-hand version shown
- Please check availability at www.secotools.com / Seco Online Store

Mini-Shaft™

Designation	Item number	OAL		CUTDIA	Weight		CTWS	
		mm	Inch		kg	lbs		
150.10A-15-1.4	02578572	33	1.299	1,2	0.047	38,0	1,4	150.10-1.4
						1.496	0.055	
150.10A-15-2	02578575	33	1.299	1,8	0.071	38,0	2,0	150.10-2
						1.496	0.079	
150.10A-15-2.5	02578577	33	1.299	2,0	0.079	38,0	2,5	150.10-2.5
						1.496	0.098	
150.10A-15-3	02578578	33	1.299	2,4	0.094	38,0	3,0	150.10-3
						1.496	0.118	
R150.10A-15-4	02578596	33	1.299	3,4	0.134	38,0	4,0	150.10-4
						1.496	0.157	
L150.10A-15-4	02578594	33	1.299	3,4	0.134	38,0	4,0	150.10-4
						1.496	0.157	

Grooving

Parting-off

Accessories

For size	Key
150.10A	150.10A-150

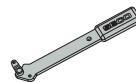

X4

Adapters
Clamping units

Accessories and
Spare parts

Workpiece
materials

Toolblock R/L150.10-..15 for HSS-blade 150.10A-..15 for Parting-off – Inch

R/L150.10
KAPR

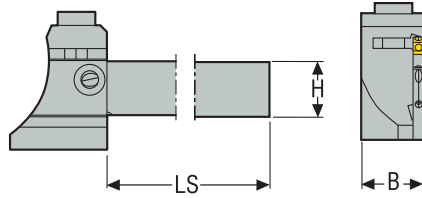
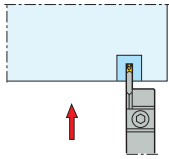

- For blades program, see page(s) 928
- * Max coolant pressure may need additional spare part according to machine side limitation
- Right-hand version shown
- Right-hand blade must only be used with Right-hand toolblock
- Left-hand blade must only be used with Left-hand toolblock
- Please check availability at www.secotools.com / Seco Online Store

Designation	Item number	H	B	LS	Weight
		Inch	Inch	Inch	lbs
R150.10-0375-15	00047748	0.375	0.375	3.228	0.440
R150.10-0500-15	00047749	0.500	0.500	3.228	0.660
R150.10-0625-15	00048456	0.625	0.625	3.228	0.880
R150.10-0750-15	00048457	0.750	0.750	3.228	0.880
R150.10-1000-15	00048458	1.000	1.000	4.724	1.540
L150.10-0625-15	00048462	0.625	0.625	3.228	0.880
L150.10-0750-15	00048463	0.750	0.750	3.228	0.880
L150.10-1000-15	00048464	1.000	1.000	4.724	1.540

Spare Parts

For size

Locking screw



R/L150.10-

UC6S1/4UNFX1

Accessories

For size

Key

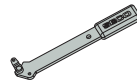

R/L150.10-

150.10A-150

General ISO Turning

Steadyline®

MDT

Mini-Shaft™

Grooving

Parting-off

X4

Adapters
Clamping units

Accessories and
Spare parts

Workpiece
materials

General ISO Turning

HSS-blade 150.10A-20/25 for Parting-off – Metric/ Inch

Steadyline®

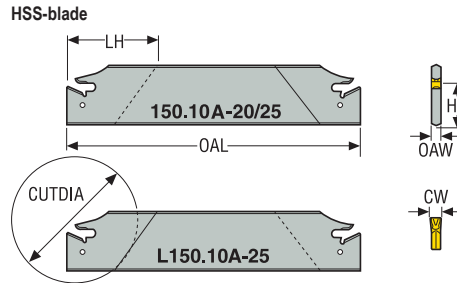
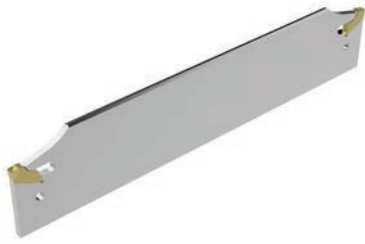

MDT

- For inserts program, see page(s) 936, 937
- Please check availability at www.secotools.com / Seco Online Store

Mini-Shaft™

Designation	Item number	OAL	OAW	CUTDIA	HF	LH	Weight	CTWS
		mm Inch	mm Inch	mm Inch	mm Inch	mm Inch		
150.10A-20-1.4	02578579	120 4.724	1,2 0.047	35,0 1.378	21,4 0.843	24,0 0.945	0,1 0.220	150.10-1.4
150.10A-20-2	02578580	120 4.724	1,8 0.071	35,0 1.378	21,4 0.843	24,0 0.945	0,1 0.220	150.10-2
150.10A-20-2.5	02578581	120 4.724	2,0 0.079	35,0 1.378	21,4 0.843	24,0 0.945	0,1 0.220	150.10-2.5
150.10A-20-3	02578582	120 4.724	2,4 0.094	90,0 3.543	21,4 0.843	– –	0,1 0.220	150.10-3
150.10A-20-4	02578583	120 4.724	3,4 0.134	100,0 3.937	21,4 0.843	– –	0,1 0.220	150.10-4
150.10A-20-5	02578584	120 4.724	4,4 0.173	120,0 4.724	21,4 0.843	– –	0,1 0.220	150.10-5
150.10A-20-6	02578585	120 4.724	5,7 0.222	120,0 4.724	21,4 0.843	– –	0,2 0.440	150.10-6
150.10A-25-1.4	02578586	150 5.906	1,2 0.047	35,0 1.378	25,0 0.984	24,0 0.945	0,1 0.220	150.10-1.4
150.10A-25-2	02578587	150 5.906	1,8 0.071	35,0 1.378	25,0 0.984	24,0 0.945	0,1 0.220	150.10-2
150.10A-25-2.5	02578588	150 5.906	2,0 0.079	35,0 1.378	25,0 0.984	24,0 0.945	0,1 0.220	150.10-2.5
150.10A-25-3	02578589	150 5.906	2,4 0.094	120,0 4.724	25,0 0.984	– –	0,1 0.220	150.10-3
150.10A-25-4	02578590	150 5.906	3,4 0.134	140,0 5.512	25,0 0.984	– –	0,2 0.440	150.10-4
150.10A-25-5	02578592	150 5.906	4,4 0.173	160,0 6.299	25,0 0.984	– –	0,2 0.440	150.10-5
150.10A-25-6	02578593	150 5.906	5,7 0.222	160,0 6.299	25,0 0.984	– –	0,2 0.440	150.10-6
L150.10A-25-1.4	02578595	150 5.906	1,2 0.047	35,0 1.378	24,9 0.980	24,0 0.945	0,1 0.220	150.10-1.4

Grooving

Parting-off

X4

Adapters
Clamping units

Accessories and
Spare parts

Workpiece
materials

Accessories

For size	Key
150.10A	150.10A-150



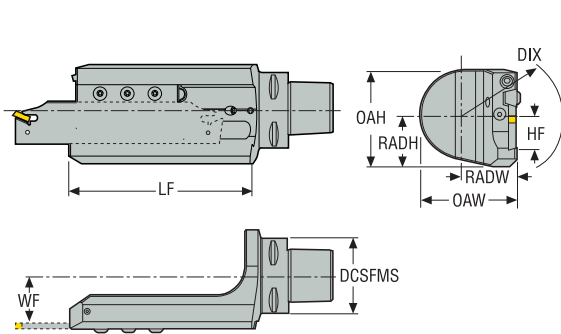

Adapters C.-R/L150.10-.20/25JETI for Parting-off – Metric/ Inch



- For blades program, see page(s) 924, 925
- For more information on Jetstream Tooling® (High pressure coolant) and accessories, please see page(s) 38, 85-89, 1002
- CTMS = Seco-Capto™ size
- * Max coolant pressure
- Right-hand version shown
- Please check availability at www.secotools.com / Seco Online Store

Designation	Item number	CTMS	DCSFMS	DIX	LF	HF	WF	OAW	OAH	RADW	RADH	CP*	Weight
													mm Inch
C5-R150.10-122-20JETI	03134584	C5	50,0 1.969	85,0 3.346	122,0 4.803	20,0 0.787	26,0 1.024	56,0 2.205	58,5 2.303	31,0 1.220	32,0 1.260	70,0 1015.3	1,4 3.090
C5-L150.10-122-20JETI	03134583	C5	50,0 1.969	85,0 3.346	122,0 4.803	20,0 0.787	26,0 1.024	56,0 2.205	58,5 2.303	31,0 1.220	32,0 1.260	70,0 1015.3	1,4 3.090
C6-R150.10-160-25JETI	03134586	C6	63,0 2.480	100,0 3.937	160,0 6.299	25,0 0.984	32,0 1.260	69,5 2.736	69,0 2.717	37,0 1.457	37,0 1.457	70,0 1015.3	2,5 5.510
C6-L150.10-160-25JETI	03134585	C6	63,0 2.480	100,0 3.937	160,0 6.299	25,0 0.984	32,0 1.260	69,5 2.736	69,0 2.717	37,0 1.457	37,0 1.457	70,0 1015.3	2,5 5.510
C8-R150.10-160-25JETI	03134591	C8	80,0 3.150	111,0 4.370	160,0 6.299	25,0 0.984	40,5 1.594	85,5 3.366	69,0 2.717	45,5 1.791	37,0 1.457	70,0 1015.3	3,4 7.500
C8-L150.10-160-25JETI	03134590	C8	80,0 3.150	111,0 4.370	160,0 6.299	25,0 0.984	40,5 1.594	85,5 3.366	69,0 2.717	45,5 1.791	37,0 1.457	70,0 1015.3	3,5 7.720

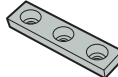
Spare Parts

For size	Coolant nozzle	O-ring	Wedge clamp	Wedge screw
C5	 CN6	 ORING-20X2	 5431080-04	 5512031-09
C6 / C8	CN7	5641005-74	5431080-02	5512031-09

General ISO Turning

Steadyline®

MDT

Mini-Shaft™

Grooving

Parting-off

X4

Adapters
Clamping units

Accessories and
Spare parts

Workpiece
materials

General ISO Turning

Adapters C.-150.10-.20/25JETI for Parting-off – Metric – Metric/ Inch

Steadyline®

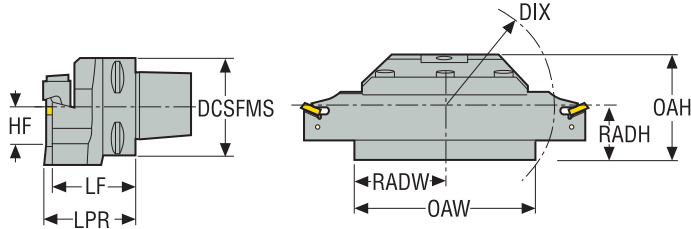

MDT

- For blades program, see page(s) 924, 925
- For more information on Jetstream Tooling® (High pressure coolant) and accessories, please see page(s) 38, 85-89, 1002
- CTMS = Seco-Capto™ size
- * Max coolant pressure
- Please check availability at www.secotools.com / Seco Online Store





Mini-Shaft™

Designation	Item number	CTMS	DCSFMS	DIX	LF	HF	OAW	OAH	RADW	RADH	CP*	Weight
			mm Inch	mm Inch	mm Inch	mm Inch	mm Inch	mm Inch	mm Inch	mm Inch	bar psi	kg lbs
C5-150.10-040-20JETI	03134581	C5	50,0 1.969	96,0 3.780	35,0 1.378	20,0 0.787	80,0 3.150	80,0 3.150	40,0 1.575	30,0 1.181	70,0 1015.3	0,9 1.980
C6-150.10-050-25JETI	03134582	C6	63,0 2.480	103,0 4.055	45,0 1.772	25,0 0.984	82,0 3.228	82,0 3.228	41,0 1.614	37,0 1.457	70,0 1015.3	1,6 3.530
C8-150.10-050-25JETI	03134589	C8	80,0 3.150	103,0 4.055	45,0 1.772	25,0 0.984	82,0 3.228	82,0 3.228	41,0 1.614	37,0 1.457	70,0 1015.3	2,6 5.730

Grooving

Spare Parts

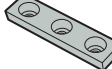
Parting-off

For size	Coolant nozzle	O-ring	Wedge clamp	Wedge screw
C5	 CN6	 ORING-20X2	 5431080-04	 5512031-09
C6 / C8	CN7	ORING-20X2	5431080-02	5512031-09

X4

Adapters
Clamping units

Accessories and
Spare parts

Workpiece
materials



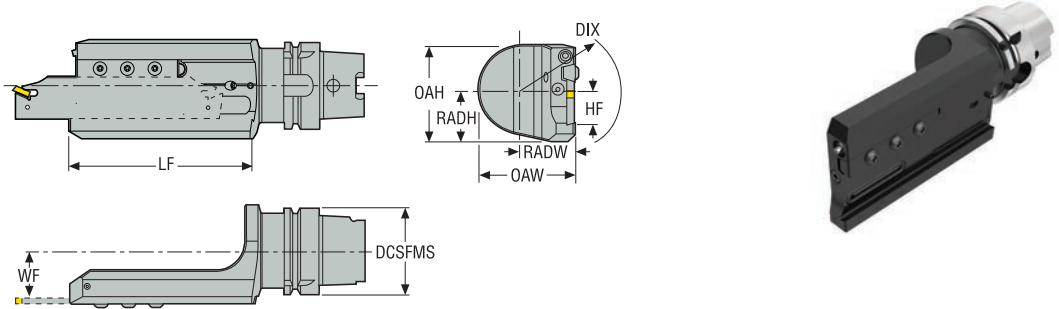

Adapters E9364-R/L150.10..-25JETI for Parting-off – Metric – Metric/ Inch



- For blades program, see page(s) 924, 925
- For more information on Jetstream Tooling® (High pressure coolant) and accessories, please see page(s) 38, 85-89, 1002
- * Max coolant pressure
- Please check availability at www.secotools.com / Seco Online Store

Designation	Item number	CTMS	DCSFMS		LF	HF	WF	OAW	OAH	RADW	RADH	CP*	Weight									
			mm	Inch										mm	Inch							
E9364-R150.10-175-25JETI	03134588	HSK-T63	63,0	2.480	175,0	6.890	25,0	0.984	32,0	1.260	69,5	2.736	69,0	2.717	37,0	1.457	37,0	1.457	70,0	1015.3	2,6	5.730
E9364-L150.10-175-25JETI	03134587	HSK-T63	63,0	2.480	175,0	6.890	25,0	0.984	32,0	1.260	69,5	2.736	69,0	2.717	37,0	1.457	37,0	1.457	70,0	1015.3	2,5	5.510

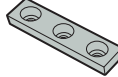
Spare Parts

For size	Coolant nozzle	O-ring	Wedge clamp	Wedge screw
E9364-R/L	 CN7	 5641005-74	 5431080-02	 5512031-09

General ISO Turning
Steadyline®
MDT
Mini-Shaft™
Grooving
Parting-off
X4
Adapters Clamping units
Accessories and Spare parts
Workpiece materials

General ISO Turning

Steadyline®

MDT

Mini-Shaft™

Grooving

Parting-off

X4

Adapters
Clamping units

Accessories and
Spare parts

Workpiece
materials

Adapters R/L150.10...20/25 for Parting-off – Metric

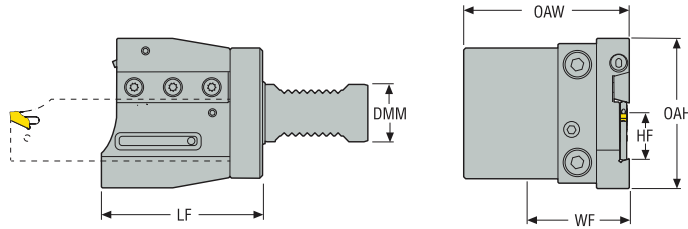

- For blades program, see page(s) 924, 925
- For more information on Jetstream Tooling® (High pressure coolant) and accessories, please see page(s) 38, 85-89, 1002
- * Max coolant pressure
- Right-hand adapter with Right-hand blade shown (Left-hand adapter must be used with Left-hand blade)
- Please check availability at www.secotools.com / Seco Online Store

Designation	Item number	DMM	LF	HF	WF	OAW	OAH	CP*	Weight
		mm	mm	mm	mm	mm	mm	bar	kg
R150.10-F-VDI25-20JETI	03070436	25,0	83,0	20,0	43,0	73,0	74,0	80,0	1,4
R150.10-F-VDI30-20JETI	03070438	30,0	90,0	20,0	50,0	85,0	74,0	80,0	1,6
R150.10-F-VDI30-25JETI	03070440	30,0	84,0	25,0	51,0	86,0	78,0	80,0	1,8
R150.10-F-VDI40-25JETI	03070442	40,0	80,0	25,0	76,0	118,5	100,0	80,0	3,0
L150.10-F-VDI25-20JETI	03070437	25,0	83,0	20,0	43,0	73,0	74,0	80,0	1,4
L150.10-F-VDI30-20JETI	03070439	30,0	90,0	20,0	50,0	85,0	74,0	80,0	1,6
L150.10-F-VDI30-25JETI	03070441	30,0	84,0	25,0	51,0	86,0	78,0	80,0	1,8
L150.10-F-VDI40-25JETI	03070443	40,0	80,0	25,0	76,0	118,5	100,0	80,0	3,0

Spare Parts

For size	Adjusting screw	Coolant nozzle	Coolant ring	Locking screw	Locking screw 2	O-ring	Pin	Wedge clamp	Wedge screw
-.F-.25-20	5333011-01	CN6	5641005-133	MC6S8X16	-	5641005-103	3111020-557	5431115-05	5513015-12
-.F-.30-20	5333011-01	CN6	5641005-133	MC6S8X20	-	5641005-134	3111020-557	5431115-05	5513015-12
-.F-.30-25	5333011-01	CN6	5641005-100	MC6S8X20	-	5641005-134	3111020-557	5431115-05	5513015-12
-.F-.40-25	5333011-01	CN6	5641005-100	MC6S8X25	5512031-10	5641005-135	3111050-609	5431115-09	5513015-12

Adapters R/L150.10...20/25 for Parting-off – Metric

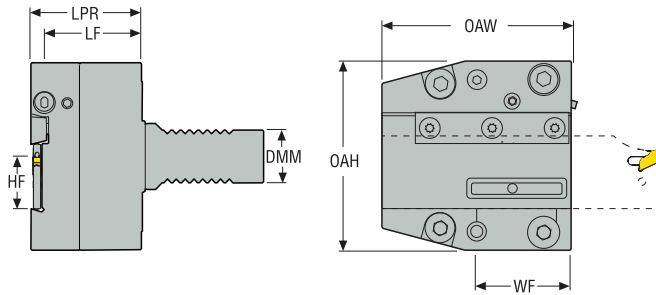

- For blades program, see page(s) 924, 925
- For more information on Jetstream Tooling® (High pressure coolant) and accessories, please see page(s) 38, 85-89, 1002
- * Max coolant pressure
- Right-hand adapter with Left-hand blade shown (Left-hand adapter must be used with Right-hand blade)
- Please check availability at www.secotools.com / Seco Online Store

Designation	Item number	DMM	LF	HF	WF	LPR	OAW	OAH	CP*	Weight
		mm	mm	mm	mm	mm	mm	mm	bar	kg
R150.10-G-VDI30-20JETI	03070428	30,0	45,5	20,0	35,0	50,5	70,0	66,0	80,0	2,0
R150.10-G-VDI30-25JETI	03070430	30,0	45,5	25,0	42,5	50,5	85,0	85,0	80,0	2,9
R150.10-G-VDI40-25JETI	03070432	40,0	45,5	25,0	42,5	50,5	85,0	85,0	80,0	3,2
R150.10-G-VDI50-25JETI	03070434	50,0	45,5	25,0	42,5	50,5	85,0	90,0	80,0	3,8
L150.10-G-VDI30-20JETI	03070429	30,0	45,5	20,0	35,0	50,5	70,0	66,0	80,0	2,0
L150.10-G-VDI30-25JETI	03070431	30,0	45,5	25,0	42,5	50,5	85,0	85,0	80,0	2,9
L150.10-G-VDI40-25JETI	03070433	40,0	45,5	25,0	42,5	50,5	85,0	85,0	80,0	3,2
L150.10-G-VDI50-25JETI	03070435	50,0	45,5	25,0	42,5	50,5	85,0	90,0	80,0	3,8

Spare Parts

For size	Adjusting screw	Coolant nozzle	Coolant ring	Locking screw	Locking screw 2	O-ring	Pin	Wedge clamp	Wedge screw
.-G-.30-20	5333011-01	CN6	5641005-133	MC6S6X20	MC6S6X25	5641005-134	3111050-611	5431115-09	5513015-12
.-G-.30-25	5333011-01	CN6	5641005-100	MC6S8X25	-	5641005-134	3111050-611	5431115-09	5513015-12
.-G-.40-25	5333011-01	CN6	5641005-100	MC6S8X25	-	5641005-135	3111050-611	5431115-09	5513015-12
.-G-.50-25	5333011-01	CN6	5641005-100	MC6S8X25	-	5641001-119	3111050-611	5431115-09	5513015-12

General ISO Turning

Steadyline®

MDT

Mini-Shaft™

Grooving

Parting-off

X4

Adapters Clamping units

Accessories and Spare parts

Workpiece materials

Inserts – Parting-off, 150.10...-12 and 150.10...-14

Please check availability at www.secotools.com / Seco Online Store

Tolerances: Size:
CW = ±0,05/0.002 1.4-2.5/1.4-2.5
CW = ±0,08/0.003 3-6/3-6

Toolholder range, see page(s) 920, 924, 925, 928, 930

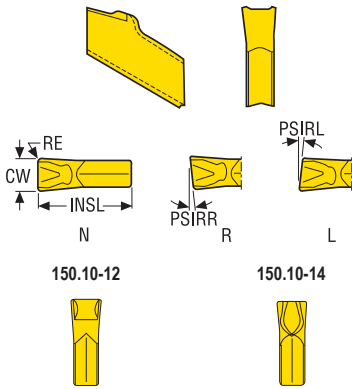

Designation	RE	CW	INSL	PSIRR°	PSIRL°	Grades							
						Coated							Uncoated
						T25M	T350M	CP500	CP600	TGP35	TGP45	TGS2050	HX
150.10-2.5N-12	0,17 0.007	2,5 0.098	9,00 0.354	-	-	■	■	■	■	■	■		
150.10-2.5R6-12	0,17 0.007	2,5 0.098	9,00 0.354	6,0	-	■			■			■	
150.10-2.5L6-12	0,17 0.007	2,5 0.098	9,00 0.354	-	6,0	■			■				
150.10-3N-12	0,19 0.007	3,1 0.122	9,00 0.354	-	-	■	■	■	■	■	■	■	
150.10-3R6-12	0,19 0.007	3,1 0.122	9,00 0.354	6,0	-	■			■			■	
150.10-3L6-12	0,19 0.007	3,1 0.122	9,00 0.354	-	6,0	■			■			■	
150.10-4N-12	0,23 0.009	4,1 0.161	9,00 0.354	-	-	■	■	■	■	■	■	■	
150.10-4R6-12	0,23 0.009	4,1 0.161	9,00 0.354	6,0	-	■							
150.10-4L6-12	0,23 0.009	4,1 0.161	9,00 0.354	-	6,0	■							
150.10-5N-12	0,26 0.010	5,1 0.201	9,00 0.354	-	-	■				■			
150.10-6N-12	0,3 0.012	6,35 0.250	9,00 0.354	-	-	■				■			
150.10-1.4N-14	0,15 0.006	1,4 0.055	9,00 0.354	-	-			■	■			■	■
150.10-2.0N-14	0,15 0.006	2,0 0.079	9,00 0.354	-	-		■	■	■		■	■	■
150.10-2.25N-14	0,15 0.006	2,25 0.089	9,00 0.354	-	-		■	■	■		■		■
150.10-2.5N-14	0,17 0.007	2,5 0.098	9,00 0.354	-	-	■		■	■		■		■
150.10-2.5R6-14	0,17 0.007	2,5 0.098	9,00 0.354	6,0	-	■			■		■	■	
150.10-2.5L6-14	0,17 0.007	2,5 0.098	9,00 0.354	-	6,0	■			■				
150.10-3N-14	0,19 0.007	3,1 0.122	9,00 0.354	-	-	■	■	■	■	■	■	■	■
150.10-3R6-14	0,19 0.007	3,1 0.122	9,00 0.354	6,0	-	■		■	■		■	■	
150.10-3L6-14	0,19 0.007	3,1 0.122	9,00 0.354	-	6,0	■			■		■	■	
150.10-4N-14	0,23 0.009	4,1 0.161	9,00 0.354	-	-	■	■	■	■	■	■	■	■
150.10-4R6-14	0,23 0.009	4,1 0.161	9,00 0.354	6,0	-	■							

Designation	RE	CW	INSL	PSIRR°	PSIRL°	Grades							
						Coated							Uncoated
	mm Inch	mm Inch	mm Inch			T25M	T350M	CP500	CP600	TGF35	TGF45	TGS2050	HX
150.10-4L6-14	0,23 0.009	4,1 0.161	9,00 0.354	-	6,0	■							
150.10-5N-14	0,26 0.010	5,1 0.201	9,00 0.354	-	-	■		■	■				
150.10-6N-14	0,3 0.012	6,35 0.250	9,00 0.354	-	-	■		■	■				
150.10-1.4N-16	0,15 0.006	1,4 0.055	9,00 0.354	-	-			■	■		■	■	
150.10-2.0N-16	0,15 0.006	2,0 0.079	9,00 0.354	-	-		■	■	■		■	■	
150.10-2.25N-16	0,15 0.006	2,25 0.089	9,00 0.354	-	-	■	■	■	■		■		■
150.10-2.5L6-16	0,17 0.007	2,5 0.098	9,00 0.354	-	6,0	■			■				
150.10-2.5N-16	0,17 0.007	2,5 0.098	9,00 0.354	-	-	■	■	■	■		■		■
150.10-2.5R6-16	0,17 0.007	2,5 0.098	9,00 0.354	6,0	-	■			■		■	■	■
150.10-3L6-16	0,19 0.007	3,1 0.122	9,00 0.354	-	6,0	■			■		■	■	
150.10-3N-16	0,19 0.007	3,1 0.122	9,00 0.354	-	-	■	■	■	■	■	■	■	■
150.10-3R6-16	0,19 0.007	3,1 0.122	9,00 0.354	6,0	-	■			■	■	■	■	
150.10-4L6-16	0,23 0.009	4,1 0.161	9,00 0.354	-	6,0	■							
150.10-4N-16	0,23 0.009	4,1 0.161	9,00 0.354	-	-	■	■	■	■	■	■	■	■
150.10-4R6-16	0,23 0.009	4,1 0.161	9,00 0.354	6,0	-	■					■		■
150.10-5L6-16	0,26 0.010	5,1 0.201	9,00 0.354	-	6,0	■							
150.10-5N-16	0,26 0.010	5,1 0.201	9,00 0.354	-	-	■		■	■	■	■		■
150.10-5R6-16	0,26 0.010	5,1 0.201	9,00 0.354	6,0	-	■							
150.10-6N-16	0,3 0.012	6,35 0.250	9,00 0.354	-	-	■		■	■	■	■		■

- General / ISO Turning
- Steadyline®
- MDT
- Mini-Shaft™
- Grooving
- Parting-off
- X4
- Adapters
Clamping units
- Accessories and
Spare parts
- Workpiece
materials



X4

The Seco X4 system with a 4-cutting-edge insert is optimized for parting-off and grooving primarily small parts. It consists of indexable tangential inserts and a highly stable clamp design. These strong, dependable system components achieve high accuracy, repeatability, productivity and surface quality in external grooving and parting-off operations involving small parts and slim bars and tubes made from a wide variety of work materials.

- Inserts with four cutting edges.
- Easy double access clamping system.
- Good repeatability ($\pm 0,025$ mm / *0.001 inch*).
- Jetstream Tooling® Duo – improves chip control and tool life of cutting edge.

X4 – General information

The Seco X4 system (multi edge solution) comprises toolholders and inserts for external radial machining.

The system can be used for:

- Grooving
- Parting off

Seco X4 comes in combination with the unique Jetstream Tooling® Duo. A high pressure cooling system which provides directed coolant supply to the cutting edge by two streams: the first to the rake surface and the second to the clearance surface.



The X4 system provides several features:

- Four cutting edges
- Ability to pass free along a shoulder down to the centre
- Easy double access clamping system
- Easy indexing without total extraction of the screw
- Integrity safe in case of edge failure. The inserts can still be used with three broken passive edges
- Good repeatability ($\pm 0,025$ mm / 0.001 inch)
- Jetstream Tooling® Duo – improves chip control and tool life of cutting edge



Set-up machining recommendations

The mounting should be stable.

The tool should be securely clamped and the overhang should be as small as possible.

The centre height should never deviate by more than $\pm 0,1$ mm / ± 0.0039 inch from the workpiece centre.

Parting-off

An insert with a neutral edge (N) normally results in a longer useful life of the insert.

The useful life of the insert can be increased by reducing the feed rate or stopping the feed entirely before breakthrough.

Formulae for cutting data calculation can be found in page(s) 102.

Seco Jetstream Tooling® Duo

Seco Jetstream Tooling® Duo holders, yet another innovation introduced to market, feature both a rake face and flank face jet, that may provide even better chip control and significantly longer tool life. For more information on Jetstream Tooling® and accessories, please see page(s) 85-89, 1002.

Troubleshooting

Troubleshooting for X4 inserts, see page(s) 914.



Seco-Capto™ – External toolholders

General ISO Turning

Steadyline®

MDT

Mini-Shaft™

Grooving

Parting-off

X4

Adapters
Clamping units

Accessories and
Spare parts

Workpiece
materials

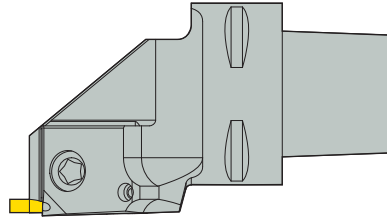

C4	- X4	F	R	27	060	- 25	03	JET
1	2	3	4	5	6	7	8	9

1. Seco-Capto™ size	2. Tool system	3. Toolholder setting angle
	X4	<p>F = 90° G = 0°</p>
4. Version	5. WF-dimension	6. LF-dimension
<p>R = Right L = Left</p>		
7. Insert length	8. Seat size	9. Cooling system
<p>25 = 25 mm / 0.984 inch</p>	<p>03 = 3,1 mm / 0.122 inch</p>	<p>JET = Jetstream Tooling® Duo JETI = Jetstream Tooling® integrated coolant inlet</p>

External toolholders



C4	F	R	25	25	M	25	03	JET
1	2	3	4	5	6	7	8	9

1. Tool system	2. Toolholder setting angle	3. Version
X4	<p>F = 90° G = 0°</p>	<p>R = Right L = Left</p>
4. Shank height	5. Shank width	6. Tool length
		<p>H = 100 mm / 3.937 inch K = 125 mm / 4.921 inch M = 150 mm / 5.906 inch</p>
7. Insert length	8. Seat size	9. Cooling system
<p>25 = 25 mm / 0.984 inch</p>	<p>03 = 3,1 mm / 0.122 inch</p>	JET = Jetstream Tooling® Duo

General ISO Turning
Steadyline®
MDT
Mini-Shaft™
Grooving
Parting-off
X4
Adapters Clamping units
Accessories and Spare parts
Workpiece materials

Inserts

General ISO Turning

Steadyline®

MDT

Mini-Shaft™

Grooving

Parting-off

X4

Adapters
Clamping units

Accessories and
Spare parts

Workpiece
materials

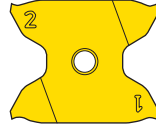

X4	G	K	25	03	010	-	0150	RR15	-	MC
1	2	3	4	5	6	7	8	9		9

1. Tool system	2. Tolerances	3. Insert type								
X4	<p>Tolerance ± mm</p> <table border="1"> <tr> <th>Tolerance class</th> <th>CW</th> <th>RE</th> <th>IGL</th> </tr> <tr> <td>G</td> <td>0,025 / 0,001</td> <td>0,03 / 0,0012</td> <td>0,025 / 0,001</td> </tr> </table>	Tolerance class	CW	RE	IGL	G	0,025 / 0,001	0,03 / 0,0012	0,025 / 0,001	<p>K = four edges with chipbreaker Left</p>
Tolerance class	CW	RE	IGL							
G	0,025 / 0,001	0,03 / 0,0012	0,025 / 0,001							

4. Insert length	5. Seat size	6. Corner radius
<p>25 = 25 mm / 0.984 inch</p>	<p>03 = 3,1 mm / 0.122 inch</p>	<p>005 = 0,05 mm / 0.0020 inch 015 = 0,15 mm / 0.0059 inch 010 = 0,10 mm / 0.0039 inch M0 = round</p>

7. Cutting edge width	8. Version	9. Chipbreaker or geometry code
<p>0050 = 0,5 mm / 0.020 inch 0300 = 3 mm / 0.120 inch</p>		<p>MC = Chipbreaker for medium Parting-off and Grooving FG = Radial groove R = Round</p>

X4 – Appliation overview

Grooving

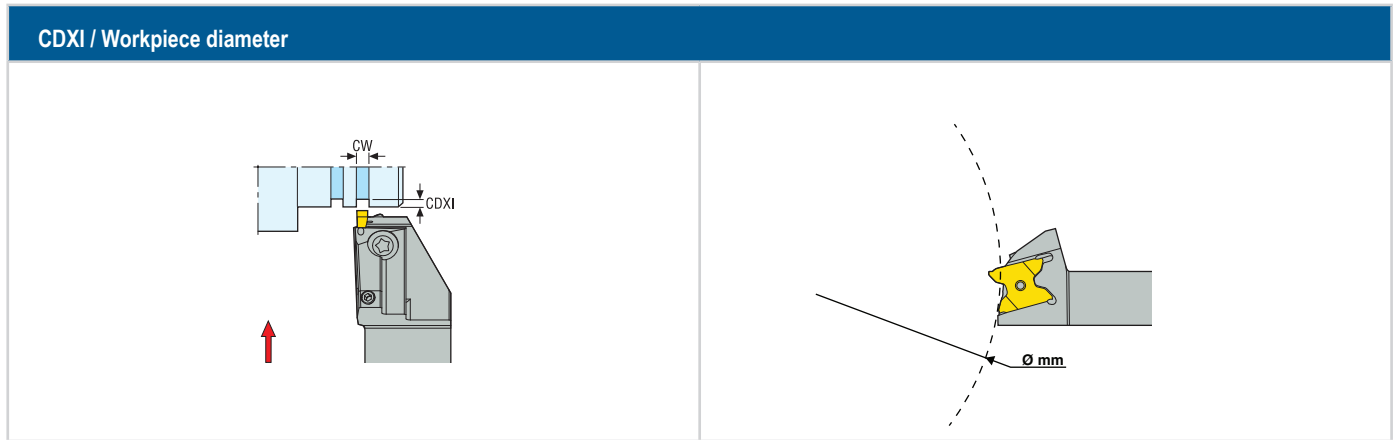

Maximum cutting depth CDXI is limited relative to workpiece diameter to avoid contact between workpiece and toolholder.

X4 Grooving – Cutting depth CDXI

Cutting edge width CW, mm / inch	Workpiece diameter, Ø mm / inch									
	0-130 0-5.118	130-140 5.118-5.512	140-160 5.512-6.299	160-180 6.299-7.087	180-200 7.087-7.874	200-250 7.874-9.843	250-300 9.843-11.811	300-400 11.811-15.748	400-500 15.748-19.686	500-1000 19.686-39.370
0,5 / 0.020	2,6 / 0.100	2,6 / 0.100	2,6 / 0.100	2,6 / 0.100	2,6 / 0.100	2,6 / 0.100	2,6 / 0.100	2,6 / 0.100	2,6 / 0.100	2,6 / 0.100
1,0 / 0.040	4,3 / 0.169	4,3 / 0.169	4,3 / 0.169	4,3 / 0.169	4,3 / 0.169	4,3 / 0.169	4,3 / 0.169	4,3 / 0.169	4,3 / 0.169	4,0 / 0.160
1,5 / 0.060	6,5 / 0.256	6,4 / 0.252	6,1 / 0.240	5,9 / 0.232	5,5 / 0.217	5,0 / 0.200	5,0 / 0.200	4,5 / 0.177	4,5 / 0.177	4,0 / 0.160
2,0 / 0.080	6,5 / 0.256	6,4 / 0.252	6,1 / 0.240	5,9 / 0.232	5,5 / 0.217	5,0 / 0.200	5,0 / 0.200	4,5 / 0.177	4,5 / 0.177	4,0 / 0.160
2,5 / 0.098	6,5 / 0.256	6,4 / 0.252	6,1 / 0.240	5,9 / 0.232	5,5 / 0.217	5,0 / 0.200	5,0 / 0.200	4,5 / 0.177	4,5 / 0.177	4,0 / 0.160
3,0 / 0.120	6,5 / 0.256	6,4 / 0.252	6,1 / 0.240	5,9 / 0.232	5,5 / 0.217	5,0 / 0.200	5,0 / 0.200	4,5 / 0.177	4,5 / 0.177	4,0 / 0.160

Parting-off

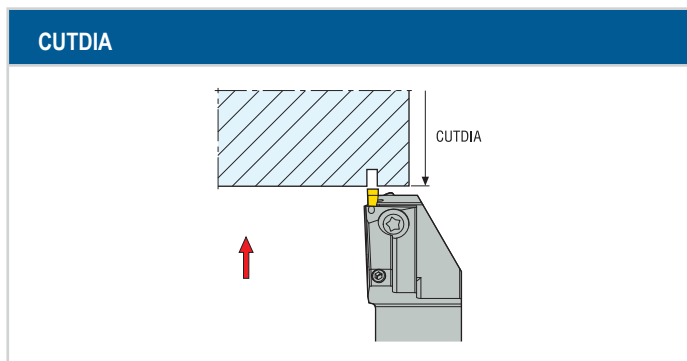

Maximum workpiece diameter, CUTDIA	
Cutting edge width CW mm / inch	Workpiece diameter, CUTDIA mm / inch
0,5 / 0.020	5,2 / 0.205
1,0 / 0.040	8,6 / 0.339
1,5 / 0.060	13,0 / 0.512
2,0 / 0.080	13,0 / 0.512
2,5 / 0.098	13,0 / 0.512
3,0 / 0.120	13,0 / 0.512

General / ISO Turning
Steadyline®
MDT
Mini-Shaft™
Grooving
Parting-off
X4
Adapters Clamping units
Accessories and Spare parts
Workpiece materials

X4 grades, coated		
General ISO Turning	<p>CP500</p>	<p>Tough PVD-coated micrograin grade intended for grooving, profiling and parting-off at moderate cutting speeds. Provides more wear resistance compared to CP600.</p> <p>(Ti,Al)N + TiN</p>
Steadyline®	<p>CP600</p>	<p>Very tough PVD-coated fine-grain grade, universal choice intended for grooving and parting-off at low to moderate cutting speeds. Well-suited in stainless steel and in interrupted cuts. Tougher alternative to CP500.</p> <p>(Ti,Al)N + TiN</p>
MDT	<p>TGH1050</p>	<p>Very hard supermicrograin grade intended for partly hardened steel components as well as generally workpiece materials such as superalloys and cast-iron and due to remarkable edge toughness it also provides high performance in interrupted cuts and hard-surface removal.</p> <p>Ti-Al-Si-N nanolaminate coating</p>

X4 grades, PCBN		
Grooving	<p>CBN200</p>	<p>Inserts with brazed tips, intended for hardened steels and pearlitic cast iron.</p> <p>Composition: 90% cBN content grade with an average grain size of 3-6 µm and a Al ceramic binder.</p> <p>Coating: No coating.</p>

Indicative ISO classification of the grades

Steel P
Stainless steel M
Cast iron K
Non-ferrous metals N
Superalloys and titanium S
Hard materials H

The application area for each grade is shown in the chart below.

The black areas in the chart indicate a grade's main ISO application groups and the white areas indicate other supplementary application groups.

	P					M					K					N				S				H					
	P01	P10	P20	P30	P40	P50	M01	M10	M20	M30	M40	K01	K10	K20	K30	K40	N01	N10	N20	N30	S01	S10	S20	S30	H01	H10	H20	H30	H40
CP500			●	●	●	●	●	●	●	●	●	●	●	●	●	●	●	●	●	●	●	●	●	●					○
CP600			●	●	●	●	●	●	●	●	●					○	●	●	●	●	●	●	●	●					○
TGH1050												○					●	●	●	●	●	●	●	●	●	●	●	●	●
CBN200												●	●	●	●	●									●	●	●	●	●

Adapters Clamping units

Accessories and Spare parts

Workpiece materials

Cutting data

Cutting speed v_c (m/min)

In this section a recommended cutting speed is indicated under specified conditions.

Use the tables beginning on page(s) 1006 to classify the workpiece material into a SMG.

The cutting data tables provide a recommendation of chipbreaker and a start value for feed rate (f) and cutting speed (v_c).

The cutting data tables are based on grooving with full cutting width (CW).

The recommended cutting speeds in the tables are calculated for 15 minutes tool life with use of external flood coolant.

In order to increase the accuracy towards the actual cutting conditions and requirements of the applications the recommendation is to use My Pages – Suggest on www.secotools.com

v_c = cutting speed (m/min / inch/min)

CW = cutting width (mm / inch)

f = feed rate (mm/rev / inch/rev)

Grade CP500

SMG		CW = 0.5-1.0 CW = 0.020-0.039		CW = 1.5-2.0 CW = 0.059-0.079		CW = 2.5-3.0 CW = 0.098-0.118	
		f	v_c	f	v_c	f	v_c
P1	-MC CP500	0,075	185	0,12	155	0,15	140
		0,0030	610	0,0048	510	0,0060	460
P2	-MC CP500	0,075	180	0,12	150	0,15	135
		0,0030	590	0,0048	490	0,0060	445
P3	-MC CP500	0,075	155	0,11	130	0,14	120
		0,0030	510	0,0044	425	0,0055	395
P4	-MC CP500	0,070	135	0,11	115	0,14	105
		0,0028	445	0,0044	375	0,0055	345
P5	-MC CP500	0,070	130	0,11	110	0,14	100
		0,0028	425	0,0044	360	0,0055	330
P6	-MC CP500	0,070	145	0,11	125	0,13	115
		0,0028	475	0,0044	410	0,0050	375
P7	-MC CP500	0,070	140	0,11	120	0,13	110
		0,0028	460	0,0044	395	0,0050	360
P8	-MC CP500	0,075	130	0,11	110	0,14	100
		0,0030	425	0,0044	360	0,0055	330
P11	-MC CP500	0,070	135	0,11	115	0,13	105
		0,0028	445	0,0044	375	0,0050	345
P12	-MC CP500	0,048	85	0,075	75	0,095	70
		0,0019	280	0,0030	245	0,0038	230
M1	-MC CP500	0,075	205	0,12	175	0,15	150
		0,0030	670	0,0048	570	0,0060	490
M2	-MC CP500	0,070	165	0,11	145	0,14	125
		0,0028	540	0,0044	475	0,0055	410
M3	-MC CP500	0,055	125	0,085	120	0,11	110
		0,0022	410	0,0034	395	0,0044	360
M4	-MC CP500	0,050	90	0,075	95	0,095	85
		0,0020	295	0,0030	310	0,0038	280
M5	-MC CP500	0,050	75	0,075	80	0,095	75
		0,0020	245	0,0030	260	0,0038	245
K1	-MC CP500	0,075	170	0,12	145	0,15	130
		0,0030	560	0,0048	475	0,0060	425
K2	-MC CP500	0,070	145	0,11	120	0,14	110
		0,0028	475	0,0044	395	0,0055	360
K3	-MC CP500	0,070	125	0,11	100	0,14	90
		0,0028	410	0,0044	330	0,0055	295
K4	-MC CP500	0,070	115	0,11	100	0,14	85
		0,0028	375	0,0044	330	0,0055	280
K5	-MC CP500	0,065	70	0,10	60	0,12	55
		0,0026	230	0,0040	195	0,0048	180
K6	-MC CP500	0,070	105	0,11	90	0,14	85
		0,0028	345	0,0044	295	0,0055	280
K7	-MC CP500	0,065	90	0,10	75	0,12	70
		0,0026	295	0,0040	245	0,0048	230
N11	-MC CP500	0,10	110	0,15	90	0,19	85
		0,0040	360	0,0060	295	0,0075	280
S1	-MC CP500	0,050	22	0,075	19	0,095	18
		0,0020	70	0,0030	60	0,0038	60
S2	-MC CP500	0,050	19	0,075	17	0,095	16
		0,0020	60	0,0030	55	0,0038	50
S3	-MC CP500	0,046	17	0,070	15	0,090	14
		0,0018	55	0,0028	49	0,0036	46

Grade CP600

SMG		CW = 0.5-1.0 CW = 0.020-0.039		CW = 1.5-2.0 CW = 0.059-0.079		CW = 2.5-3.0 CW = 0.098-0.118	
		f	v _c	f	v _c	f	v _c
P1	-MC CP600	0,075	170	0,12	145	0,15	130
		0.0030	560	0.0048	475	0.0060	425
		0,075	165	0,12	140	0,15	130
P2	-MC CP600	0.0030	540	0.0048	460	0.0060	425
		0,075	145	0,11	125	0,14	115
P3	-MC CP600	0.0030	475	0.0044	410	0.0055	375
		0,070	130	0,11	110	0,14	100
P4	-MC CP600	0.0028	425	0.0044	360	0.0055	330
		0,070	125	0,11	105	0,14	95
P5	-MC CP600	0.0028	410	0.0044	345	0.0055	310
		0,070	140	0,11	115	0,13	110
P6	-MC CP600	0.0028	460	0.0044	375	0.0050	360
		0,070	130	0,11	110	0,13	105
P7	-MC CP600	0.0028	425	0.0044	360	0.0050	345
		0,075	120	0,11	105	0,14	95
P8	-MC CP600	0.0030	395	0.0044	345	0.0055	310
		0,070	125	0,11	105	0,13	100
P11	-MC CP600	0.0028	410	0.0044	345	0.0050	330
		0,048	80	0,075	70	0,095	65
P12	-MC CP600	0.0019	260	0.0030	230	0.0038	215
		0,075	190	0,12	165	0,15	140
M1	-MC CP600	0.0030	620	0.0048	540	0.0060	460
		0,070	155	0,11	140	0,14	120
M2	-MC CP600	0.0028	510	0.0044	460	0.0055	395
		0,055	115	0,085	115	0,11	105
M3	-MC CP600	0.0022	375	0.0034	375	0.0044	345
		0,050	85	0,075	85	0,095	80
M4	-MC CP600	0.0020	280	0.0030	280	0.0038	260
		0,050	70	0,075	75	0,095	70
M5	-MC CP600	0.0020	230	0.0030	245	0.0038	230
		0,075	160	0,12	135	0,15	125
K1	-MC CP600	0.0030	520	0.0048	445	0.0060	410
		0,070	135	0,11	115	0,14	100
K2	-MC CP600	0.0028	445	0.0044	375	0.0055	330
		0,070	115	0,11	95	0,14	85
K3	-MC CP600	0.0028	375	0.0044	310	0.0055	280
		0,070	110	0,11	90	0,14	80
K4	-MC CP600	0.0028	360	0.0044	295	0.0055	260
		0,065	65	0,10	55	0,12	50
K5	-MC CP600	0.0026	215	0.0040	180	0.0048	165
		0,070	100	0,11	85	0,14	80
K6	-MC CP600	0.0028	330	0.0044	280	0.0055	260
		0,065	85	0,12	65	0,14	65
K7	-MC CP600	0.0026	280			0.0048	215
X4	N11	-MC CP600					
	S1	-MC CP600					
	S2	-MC CP600					
	S3	-MC CP600					

Adapters
Clamping units

Accessories and
Spare parts

Workpiece
materials

Grade TGH1050

SMG		CW = 0.5-1.0 CW = 0.020-0.039		CW = 1.5-2.0 CW = 0.059-0.079		CW = 2.5-3.0 CW = 0.098-0.118	
		f	V _c	f	V _c	f	V _c
K1	-MC TGH1050	—	—	—	—	—	—
K2	-MC TGH1050	—	—	—	—	—	—
K3	-MC TGH1050	—	—	—	—	—	—
S1	-MC TGH1050	—	—	—	—	—	—
S2	-MC TGH1050	—	—	—	—	—	—
S3	-MC TGH1050	—	—	—	—	—	—
H3	-MC TGH1050	0,032 0,0013	49 160	0,050 0,0020	50 165	0,060 0,0024	50 165
H5	-MC TGH1050	0,048 0,0019	95 310	0,075 0,0030	90 295	0,095 0,0038	85 280
H7	-MC TGH1050	0,032 0,0013	49 160	0,050 0,0020	50 165	0,060 0,0024	50 165
H8	-MC TGH1050	0,036 0,0014	90 295	0,055 0,0022	95 310	0,070 0,0028	90 295
H11	-MC TGH1050	0,048 0,0019	120 395	0,075 0,0030	115 375	0,095 0,0038	110 360
H12	-MC TGH1050	0,036 0,0014	105 345	0,055 0,0022	110 360	0,070 0,0028	105 345
H21	-MC TGH1050	0,036 0,0014	90 295	0,055 0,0022	95 310	0,070 0,0028	90 295
H31	-MC TGH1050	0,032 0,0013	70 230	0,050 0,0020	70 230	0,060 0,0024	70 230

- General ISO Turning
- Steadyline®
- MDT
- Mini-Shaft™
- Grooving
- Parting-off
- X4
- Adapters
Clamping units
- Accessories and
Spare parts
- Workpiece
materials

General ISO Turning

C.-X4FR/L...JET – Toolholders for inserts X4GK – Metric/ Inch

Steadyline®



CTWS



- For inserts program, see page(s) 955-959
- For CW and CDXI, see inserts page(s) 943
- * Max coolant pressure
- CTMS = Seco-Capto™ size
- CTWS = Insert shape and size
- For more information on Jetstream Tooling® (High pressure coolant) and accessories, please see page(s) 38, 85-89, 1002
- Right-hand version shown
- Right-hand holder must only be used with Right-hand insert (RN/RR/RL)
- Left-hand holder must only be used with Left-hand insert (LN/LR/LL)
- Please check availability at www.secotools.com / Seco Online Store

MDT

Mini-Shaft™

Grooving

Parting-off

X4

Adapters Clamping units

Accessories and Spare parts

Workpiece materials

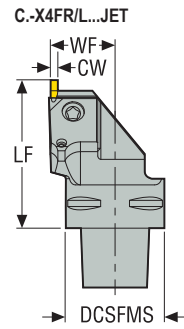

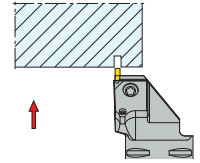

X4FR/L...JET
KAPR = 90,0 °



Designation	Item number	CTMS	DCSFMS		LF	CP*	Weight		CTWS				
			mm	Inch			kg	lbs					
C4-X4FR-27060-2503JET	02823293	C4	40,0	1.575	27,0	1.063	60,0	2.362	70,0	1015.3	0,7	1.540	X42503R
C4-X4FL-27060-2503JET	02823290	C4	40,0	1.575	27,0	1.063	60,0	2.362	70,0	1015.3	0,7	1.540	X42503L
C5-X4FR-35060-2503JET	02823294	C5	50,0	1.969	35,0	1.378	60,0	2.362	70,0	1015.3	0,9	1.980	X42503R
C5-X4FL-35060-2503JET	02823291	C5	50,0	1.969	35,0	1.378	60,0	2.362	70,0	1015.3	0,9	1.980	X42503L
C6-X4FR-45065-2503JET	02823295	C6	63,0	2.480	45,0	1.772	65,0	2.559	70,0	1015.3	1,2	2.650	X42503R
C6-X4FL-45065-2503JET	02823292	C6	63,0	2.480	45,0	1.772	65,0	2.559	70,0	1015.3	1,2	2.650	X42503L

Spare Parts

For size	Clamp key	Clamp screw
-2503	 T15P-7	 L85020-T15P

X4FR/L...JETI – Toolholders compatible with JETI adapters for inserts X4GK – Metric



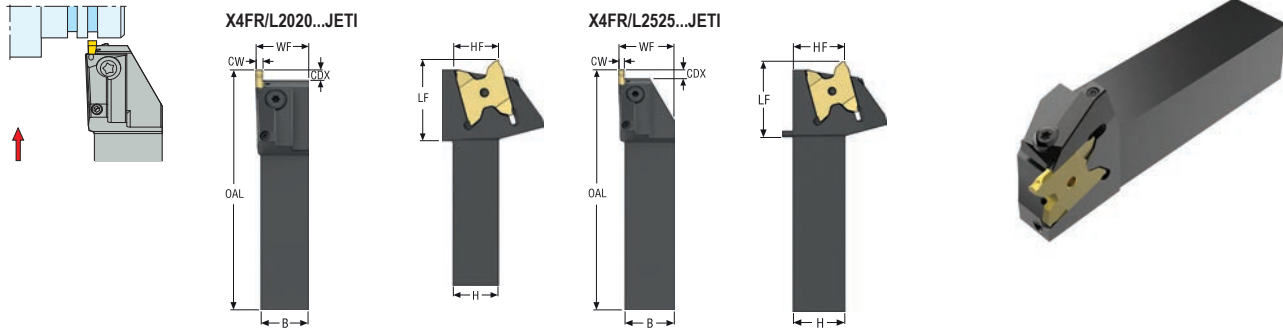

X4FR/L...JETI
KAPR = 90,0°



- For inserts program, see page(s) 955-959
- For suitable adapter, see page(s) 962-973
- For CW and CDXI, see inserts page(s) 943
- * When using toolholder together with an adapter the maximum coolant pressure might be limited, please see page(s) 85
- For more information on Jetstream Tooling® (High pressure coolant) and accessories, please see page(s) 38, 85-89, 1002
- Right-hand version shown
- Right-hand holder must only be used with Right-hand insert (RN/RR/RL)
- Left-hand holder must only be used with Left-hand insert (LN/LR/LL)
- Please check availability at www.secotools.com / Seco Online Store

Designation	Item number	H	B	OAL	LF	WF	HF	CP*	Weight	CTWS
		mm	mm	mm	mm	mm	mm	bar	kg	
X4FR2020X2503JETI	03244928	20	20	100	36	22,0	20,0	200,0	0,4	X4GK25..RN/RR/RL..
X4FR2525X2503JETI	03244929	25	25	121	37	28,0	25,0	200,0	0,6	X4GK25..RN/RR/RL..
X4FL2020X2503JETI	03244926	20	20	100	36	22,0	20,0	200,0	0,3	X4GK25..LN/LR/LL...
X4FL2525X2503JETI	03244927	25	25	121	37	28,0	25,0	200,0	0,6	X4GK25..LN/LR/LL...

Spare Parts

For size	Clamp key	Clamp screw	Plug	Plug screw
-2503	 T15P-7	 L85020-T15P	 JET-P1/8-5MM	 P6SS6X6

General ISO Turning

Steadyline®

MDT

Mini-Shaft™

Grooving

Parting-off

X4

Adapters Clamping units

Accessories and Spare parts

Workpiece materials

General ISO Turning

X4FR/L...JET – Toolholders for inserts X4GK – Metric

Steadyline®

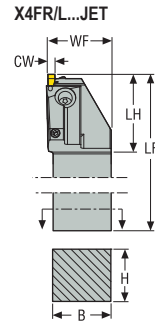

X4FR/L...JET
KAPR = 90,0 °

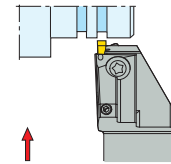

MDT

CTWS



- For inserts program, see page(s) 955-959
- For CW and CDXI, see inserts page(s) 943
- * Max coolant pressure
- For more information on Jetstream Tooling® (High pressure coolant) and accessories, please see page(s) 38, 85-89, 1002
- Right-hand version shown
- Right-hand holder must only be used with Right-hand insert (RN/RR/RL)
- Left-hand holder must only be used with Left-hand insert (LN/LR/LL)
- Please check availability at www.secotools.com / Seco Online Store

Mini-Shaft™

Designation	Item number	H	B	LF	WF	LH	CP*	Weight	CTWS
		mm	mm	mm	mm	mm	bar	kg	
X4FR1616M2503JET	02823286	16	16	150	18,0	36,0	275,0	0,4	X4GK25..RN/RR/RL..
X4FL1616M2503JET	02823245	16	16	150	18,0	36,0	275,0	0,4	X4GK25..LN/LR/LL...

Grooving

Spare Parts

Parting-off

For size	Clamp key	Clamp screw	Plug
-2503	 T15P-7	 L85020-T15P	 JET-P1/8-5MM

X4

Adapters
Clamping units

Accessories and
Spare parts

Workpiece
materials

X4FR/L...JET – Toolholders for inserts X4GK – Inch

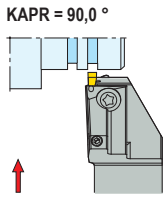

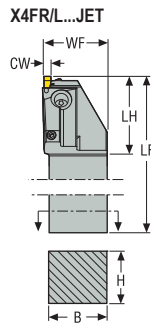

KAPR = 90,0°



- For inserts program, see page(s) 955-959
- For CW and CDXI, see inserts page(s) 943
- * Max coolant pressure
- For more information on Jetstream Tooling® (High pressure coolant) and accessories, please see page(s) 38, 85-89, 1002
- Right-hand version shown
- Right-hand holder must only be used with Right-hand insert (RN/RR/RL)
- Left-hand holder must only be used with Left-hand insert (LN/LR/LL)
- Please check availability at www.secotools.com / Seco Online Store

Designation	Item number	H	B	LF	WF	LH	CP*	Weight	CTWS
		Inch	Inch	Inch	Inch	Inch	psi	lbs	
X4FR0632503DJET	02823299	0.625	0.625	6.000	0.750	1.441	3988.5	0.880	X42503R
X4FR0752503DJET	02823300	0.750	0.750	6.000	0.866	1.441	3988.5	1.100	X42503R
X4FR1002503DJET	02823301	1.000	1.000	6.000	1.102	1.441	3988.5	1.760	X42503R
X4FL0632503DJET	02823296	0.625	0.625	6.000	0.750	1.441	3988.5	0.880	X42503L
X4FL0752503DJET	02823297	0.750	0.750	6.000	0.866	1.441	3988.5	1.100	X42503L
X4FL1002503DJET	02823298	1.000	1.000	6.000	1.102	1.441	3988.5	1.760	X42503L

Spare Parts

For size	Clamp key	Clamp screw	Plug
-2503	 T15P-7	 L85020-T15P	 JET-P1/8-5MM

General / ISO Turning

Steadyline®

MDT

Mini-Shaft™

Grooving

Parting-off

X4

Adapters
Clamping units

Accessories and
Spare parts

Workpiece
materials

General ISO Turning

X4FR/L – Toolholders for inserts X4GK – Metric

Steadyline®

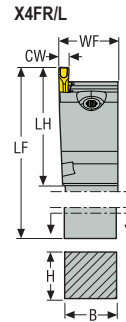

X4FR/L
KAPR = 90,0 °

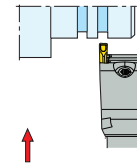

MDT

CTWS



- For inserts program, see page(s) 955-959
- For CW and CDXI, see inserts page(s) 943
- Right-hand version shown
- Right-hand holder must only be used with Right-hand insert (RN/RR/RL)
- Left-hand holder must only be used with Left-hand insert (LN/LR/LL)
- Please check availability at www.secotools.com / Seco Online Store



Mini-Shaft™

Designation	Item number	H	B	LF	WF	LH	Weight	CTWS
		mm	mm	mm	mm	mm	kg	
X4FR1212K2503	02919944	12	12	125	11,9	36,6	0,2	X4GK25..RN/RR/RL..
X4FR1616K2503	02919937	16	16	125	18,0	36,6	0,3	X4GK25..RN/RR/RL..
X4FR2020M2503	02968134	20	20	150	22,0	36,0	0,6	X4GK25..RN/RR/RL..
X4FR2525M2503	02953258	25	25	150	28,0	36,0	0,8	X4GK25..RN/RR/RL..
X4FL1212K2503	02919935	12	12	125	11,9	36,6	0,2	X4GK25..LN/LR/LL...
X4FL1616K2503	02919936	16	16	125	18,0	36,6	0,3	X4GK25..LN/LR/LL...
X4FL2020M2503	02968135	20	20	150	22,0	36,0	0,6	X4GK25..LN/LR/LL...
X4FL2525M2503	02953259	25	25	150	28,0	36,0	0,8	X4GK25..LN/LR/LL...

Grooving

Parting-off

Spare Parts

For size	Clamp key	Clamp screw
-2503	 T15P-7	 L85020-T15P

X4

Adapters
Clamping units

Accessories and
Spare parts

Workpiece
materials

X4FR/L – Toolholders for inserts X4GK – Inch

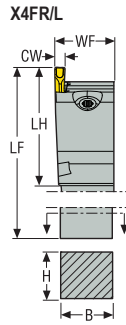
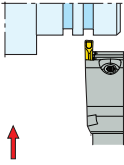

X4FR/L
KAPR = 90,0°



- For inserts program, see page(s) 955-959
- For CW and CDXI, see inserts page(s) 943
- Right-hand version shown
- Right-hand holder must only be used with Right-hand insert (RN/RR/RL)
- Left-hand holder must only be used with Left-hand insert (LN/LR/LL)
- Please check availability at www.secotools.com / Seco Online Store

Designation	Item number	H	B	LF	WF	LH	Weight	CTWS
		Inch	Inch	Inch	Inch	Inch	lbs	
X4FR050C2503	02933930	0.496	0.496	4.961	0.500	1.441	0.440	X42503R
X4FR063C2503	02933932	0.625	0.625	4.961	0.709	1.441	0.660	X42503R
X4FR0752503D	02968139	0.750	0.750	6.000	0.866	1.417	1.100	X42503R
X4FR1002503D	02968136	0.984	0.984	6.000	1.102	1.417	1.760	X42503R
X4FL050C2503	02933931	0.496	0.496	4.961	0.500	1.441	0.440	X42503L
X4FL063C2503	02933933	0.625	0.625	4.961	0.709	1.441	0.660	X42503L
X4FL0752503D	02968140	0.787	0.787	5.906	0.866	1.417	1.100	X42503L
X4FL1002503D	02968137	0.984	0.984	6.000	1.102	1.417	1.760	X42503L

Spare Parts

For size	Clamp key	Clamp screw
-2503	 T15P-7	 L85020-T15P

General / ISO Turning

Steadyline®

MDT

Mini-Shaft™

Grooving

Parting-off

X4

Adapters
Clamping units

Accessories and
Spare parts

Workpiece
materials

General ISO Turning

X4FR/L...ITX – Toolholders for inserts X4GK – Metric

Steadyline®

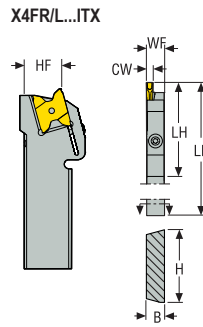

X4FR/L...ITX
KAPR = 90,0 °

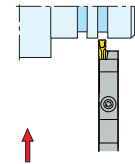

MDT

CTWS



- For inserts program, see page(s) 955-960
- For CW and CDXI, see inserts page(s) 943
- Right-hand version shown
- Right-hand holder must only be used with Right-hand insert (RN/RR/RL)
- Left-hand holder must only be used with Left-hand insert (LN/LR/LL)
- Please check availability at www.secotools.com / Seco Online Store

Mini-Shaft™

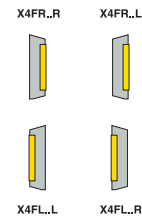

Designation	Item number	H	B	LF	WF	HF	LH	Weight	CTWS
		mm	mm	mm	mm	mm	mm	kg	
X4FR26ITX2503R	02866967	26	7,85	119,5	7,85	21,4	47,0	0,2	X4GK25..RN/RR/RL..
X4FR32ITX2503R	02877941	32	7,85	119,5	7,85	25,0	47,0	0,3	X4GK25..RN/RR/RL..
X4FL26ITX2503R	02870671	26	7,85	119,5	7,85	21,4	47,0	0,2	X4GK25..LN/LR/LL...
X4FL32ITX2503R	02877939	32	7,85	119,5	7,85	25,0	47,0	0,3	X4GK25..LN/LR/LL...
X4FR26ITX2503L	02870670	26	7,85	119,5	7,85	21,4	47,0	0,2	X4GK25..RN/RR/RL..
X4FR32ITX2503L	02877940	32	7,85	119,5	7,85	25,0	47,0	0,3	X4GK25..RN/RR/RL..
X4FL26ITX2503L	02870672	26	7,85	119,5	7,85	21,4	47,0	0,2	X4GK25..LN/LR/LL...
X4FL32ITX2503L	02877938	32	7,85	119,1	7,85	25,0	47,0	0,3	X4GK25..LN/LR/LL...

Grooving

Parting-off

Spare Parts

X4

For size	Clamp key	Clamp screw
26-32	T09P-2	L84017-T09P

Adapters
Clamping units

Accessories and
Spare parts

Workpiece
materials

X4GK

* Maximum cutting depth CDXI is limited relative to workpiece diameter to avoid contact between workpiece and toolholder, see guide page(s) 943

Right-hand insert (RN/RR/RL) must only be used with Right-hand holder

Please check availability at www.secotools.com / Seco Online Store

Tolerances:
 CW = $\pm 0,025/0,001$
 CDXI = $\pm 0,1/0,004$
 S = $\pm 0,025/0,001$
 RE = $\pm 0,03/0,0012$

PSIRR/PSIRL = $\pm 0,25^\circ$

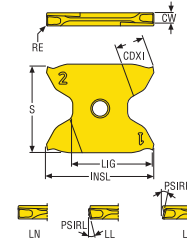

RN-MC



RR-MC



RL-MC



Designation	RE	CW	LIG	INSL	S	CDXI*	PSIRR°	PSIRL°	Grades Coated		
									CP500	CP600	TGH1050
	mm Inch	mm Inch	mm Inch	mm Inch	mm Inch	mm Inch					
X4GK2503005-0050RN-MC	0,05 0.002	0,5 0.020	19,0 0.748	25,44 1.002	20,40 0.803	2,6 0.102	0	0	■	■	■
X4GK2503005-0100RN-MC	0,05 0.002	1,0 0.039	19,0 0.748	25,44 1.002	20,40 0.803	4,3 0.169	0	0	■	■	■
X4GK2503010-0150RN-MC	0,1 0.004	1,5 0.059	19,0 0.748	25,44 1.001	20,40 0.803	6,5 0.256	0	0	■	■	■
X4GK2503010-0200RN-MC	0,1 0.004	2,0 0.079	19,0 0.748	25,44 1.001	20,40 0.803	6,5 0.256	0	0	■	■	■
X4GK2503015-0250RN-MC	0,15 0.006	2,5 0.098	19,0 0.748	25,43 1.001	20,39 0.803	6,5 0.256	0	0	■	■	■
X4GK2503015-0300RN-MC	0,15 0.006	3,0 0.118	19,0 0.748	25,43 1.001	20,39 0.803	6,5 0.256	0	0	■	■	■
X4GK2503020-0150RN-MC	0,2 0.008	1,5 0.059	19,0 0.748	25,44 1.001	20,40 0.803	6,5 0.256	0	0	■	■	■
X4GK2503020-0200RN-MC	0,2 0.008	2,0 0.079	19,0 0.748	25,44 1.001	20,40 0.803	6,5 0.256	0	0	■	■	■
X4GK2503030-0250RN-MC	0,3 0.012	2,5 0.098	19,0 0.748	25,43 1.001	20,39 0.803	6,5 0.256	0	0	■	■	■
X4GK2503030-0300RN-MC	0,3 0.012	3,0 0.118	19,0 0.748	25,43 1.001	20,39 0.803	6,5 0.256	0	0	■	■	■
X4GK2503005-0100RR15-MC	0,05 0.002	1,0 0.039	19,0 0.748	25,40 1.000	20,36 0.802	4,3 0.169	15	0	■	■	■
X4GK2503005-0150RR15-MC	0,05 0.002	1,5 0.059	19,0 0.748	25,37 0.999	20,34 0.801	6,5 0.256	15	0	■	■	■
X4GK2503010-0150RR15-MC	0,1 0.004	1,5 0.059	19,0 0.748	25,37 0.999	20,34 0.801	6,5 0.256	15	0	■	■	■
X4GK2503010-0200RR15-MC	0,1 0.004	2,0 0.079	19,0 0.748	25,35 0.998	20,32 0.800	6,5 0.256	15	0	■	■	■
X4GK2503015-0250RR15-MC	0,15 0.006	2,5 0.098	18,9 0.744	25,32 0.997	20,30 0.799	6,5 0.256	15	0	■	■	■
X4GK2503015-0300RR06-MC	0,15 0.006	3,0 0.118	18,9 0.744	25,31 0.996	20,28 0.798	6,5 0.256	6	0	■	■	■
X4GK2503005-0100RL15-MC	0,05 0.002	1,0 0.039	19,0 0.748	25,44 1.002	20,40 0.803	4,3 0.169	0	15	■	■	■
X4GK2503010-0150RL15-MC	0,1 0.004	1,5 0.059	19,0 0.748	25,43 1.001	20,39 0.803	6,5 0.256	0	15	■	■	■
X4GK2503010-0200RL15-MC	0,1 0.004	2,0 0.079	19,0 0.748	25,43 1.001	20,39 0.803	6,5 0.256	0	15	■	■	■
X4GK2503015-0250RL15-MC	0,15 0.006	2,5 0.098	19,0 0.748	25,43 1.001	20,39 0.803	6,5 0.256	0	15	■	■	■
X4GK2503015-0300RL06-MC	0,15 0.006	3,0 0.118	19,0 0.748	25,43 1.001	20,39 0.803	6,5 0.256	0	6	■	■	■

General ISO Turning

Steadyline®

MDT

Mini-Shaft™

Grooving

Parting-off

X4

Adapters
Clamping units

Accessories and
Spare parts

Workpiece
materials

X4GK

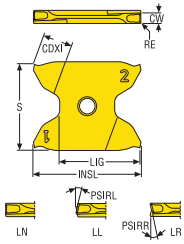

Tolerances:
 CW = $\pm 0,025/0,001$
 CDXI = $\pm 0,1/0,004$
 S = $\pm 0,025/0,001$
 RE = $\pm 0,03/0,0012$

PSIRR/PSIRL = $\pm 0,25^\circ$

* Maximum cutting depth CDXI is limited relative to workpiece diameter to avoid contact between workpiece and toolholder, see guide page(s) 943

Left-hand insert (LN/LR/LL) must only be used with Left-hand holder

Please check availability at www.secotools.com / Seco Online Store

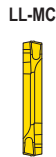
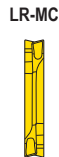
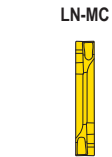

Designation	RE	CW	LIG	INSL	S	CDXI*	PSIRR°	PSIRL°	Grades Coated		
	mm Inch	mm Inch	mm Inch	mm Inch	mm Inch	mm Inch			CP500	CP600	TGH1050
X4GK2503005-0050LN-MC	0,05 0.002	0,5 0.020	19,0 0.748	25,44 1.002	20,40 0.803	2,6 0.102	0	0		■	■
X4GK2503005-0100LN-MC	0,05 0.002	1,0 0.039	19,0 0.748	25,44 1.002	20,40 0.803	4,3 0.169	0	0		■	■
X4GK2503010-0150LN-MC	0,1 0.004	1,5 0.059	19,0 0.748	25,44 1.001	20,40 0.803	6,5 0.256	0	0	■	■	■
X4GK2503010-0200LN-MC	0,1 0.004	2,0 0.079	19,0 0.748	25,44 1.001	20,40 0.803	6,5 0.256	0	0	■	■	■
X4GK2503015-0250LN-MC	0,15 0.006	2,5 0.098	19,0 0.748	25,43 1.001	20,39 0.803	6,5 0.256	0	0	■	■	■
X4GK2503015-0300LN-MC	0,15 0.006	3,0 0.118	19,0 0.748	25,43 1.001	20,39 0.803	6,5 0.256	0	0	■	■	■
X4GK2503020-0150LN-MC	0,2 0.008	1,5 0.059	19,0 0.748	25,44 1.001	20,40 0.803	6,5 0.256	0	0	■		
X4GK2503020-0200LN-MC	0,2 0.008	2,0 0.079	19,0 0.748	25,44 1.001	20,40 0.803	6,5 0.256	0	0	■		
X4GK2503030-0250LN-MC	0,3 0.012	2,5 0.098	19,0 0.748	25,43 1.001	20,39 0.803	6,5 0.256	0	0	■		
X4GK2503030-0300LN-MC	0,3 0.012	3,0 0.118	19,0 0.748	25,43 1.001	20,39 0.803	6,5 0.256	0	0	■		
X4GK2503005-0100LR15-MC	0,05 0.002	1,0 0.039	19,0 0.748	25,44 1.002	20,40 0.803	4,3 0.169	15	0		■	
X4GK2503010-0150LR15-MC	0,1 0.004	1,5 0.059	19,0 0.748	25,43 1.001	20,39 0.803	6,5 0.256	15	0	■	■	
X4GK2503010-0200LR15-MC	0,1 0.004	2,0 0.079	19,0 0.748	25,43 1.001	20,39 0.803	6,5 0.256	15	0		■	
X4GK2503015-0250LR15-MC	0,15 0.006	2,5 0.098	19,0 0.748	25,43 1.001	20,39 0.803	6,5 0.256	15	0		■	
X4GK2503015-0300LR06-MC	0,15 0.006	3,0 0.118	19,0 0.748	25,43 1.001	20,39 0.803	6,5 0.256	6	0		■	
X4GK2503005-0100LL15-MC	0,05 0.002	1,0 0.039	19,0 0.748	25,40 1.000	20,36 0.802	4,3 0.169	0	15		■	
X4GK2503005-0150LL15-MC	0,05 0.002	1,5 0.059	19,0 0.748	25,37 0.999	20,34 0.801	6,5 0.256	0	15	■		
X4GK2503010-0150LL15-MC	0,1 0.004	1,5 0.059	19,0 0.748	25,37 0.999	20,34 0.801	6,5 0.256	0	15	■	■	
X4GK2503010-0200LL15-MC	0,1 0.004	2,0 0.079	19,0 0.748	25,35 0.998	20,32 0.800	6,5 0.256	0	15		■	
X4GK2503015-0250LL15-MC	0,15 0.006	2,5 0.098	18,9 0.744	25,32 0.997	20,30 0.799	6,5 0.256	0	15		■	
X4GK2503015-0300LL06-MC	0,15 0.006	3,0 0.118	18,9 0.744	25,31 0.996	20,28 0.798	6,5 0.256	0	6		■	

X4GK

* Maximum cutting depth CDXI is limited relative to workpiece diameter to avoid contact between workpiece and toolholder, see guide page(s) 943

Tolerances:
CW = $\pm 0,025/0.001$
CDXI = $\pm 0,1/0.004$
S = $\pm 0,025/0.001$
RE = $\pm 0,03/0.0012$

Right-hand insert (RN/RR/RL) must only be used with Right-hand holder

Left-hand insert (LN/LR/LL) must only be used with Left-hand holder

Please check availability at www.secotools.com / Seco Online Store

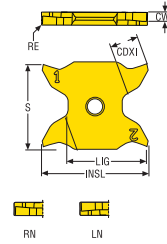

RN-FG



LN-FG



Designation	RE	CW	LIG	INSL	S	CDXI*	Grades Coated		
							CP600	CP600	TGH1050
X4GK2503010-0115RN-FG	0,1 0.004	1,15 0.045	19,0 0.748	25,44 1.001	20,40 0.803	4,3 0.169	■		
X4GK2503010-0135RN-FG	0,1 0.004	1,35 0.053	19,0 0.748	25,44 1.001	20,40 0.803	4,3 0.169	■		
X4GK2503010-0165RN-FG	0,1 0.004	1,65 0.065	19,0 0.748	25,44 1.001	20,40 0.803	6,5 0.256	■		
X4GK2503010-0190RN-FG	0,1 0.004	1,9 0.075	19,0 0.748	25,44 1.001	20,40 0.803	6,5 0.256	■		
X4GK2503015-0215RN-FG	0,15 0.006	2,15 0.085	19,0 0.748	25,43 1.001	20,39 0.803	6,5 0.256	■		
X4GK2503015-0265RN-FG	0,15 0.006	2,65 0.104	19,0 0.748	25,43 1.001	20,39 0.803	6,5 0.256	■		
X4GK2503005-0050RN-FG	0,05 0.002	0,5 0.020	19,0 0.748	25,44 1.001	20,40 0.803	2,6 0.102			■
X4GK2503005-0100RN-FG	0,05 0.002	1,0 0.039	19,0 0.748	25,44 1.001	20,40 0.803	4,3 0.169			■
X4GK2503010-0150RN-FG	0,1 0.004	1,5 0.059	19,0 0.748	25,44 1.001	20,40 0.803	6,5 0.256			■
X4GK2503010-0200RN-FG	0,1 0.004	2,0 0.079	19,0 0.748	25,44 1.001	20,40 0.803	6,5 0.256			■
X4GK2503015-0250RN-FG	0,15 0.006	2,5 0.098	19,0 0.748	25,44 1.001	20,40 0.803	6,5 0.256			■
X4GK2503015-0300RN-FG	0,15 0.006	3,0 0.118	19,0 0.748	25,44 1.001	20,40 0.803	6,5 0.256			■
X4GK2503010-0115LN-FG	0,1 0.004	1,15 0.045	19,0 0.748	25,44 1.001	20,40 0.803	4,3 0.169	■		
X4GK2503010-0135LN-FG	0,1 0.004	1,35 0.053	19,0 0.748	25,44 1.001	20,40 0.803	4,3 0.169	■		
X4GK2503010-0165LN-FG	0,1 0.004	1,65 0.065	19,0 0.748	25,44 1.001	20,40 0.803	6,5 0.256	■		
X4GK2503010-0190LN-FG	0,1 0.004	1,9 0.075	19,0 0.748	25,44 1.001	20,40 0.803	6,5 0.256	■		
X4GK2503015-0215LN-FG	0,15 0.006	2,15 0.085	19,0 0.748	25,43 1.001	20,39 0.803	6,5 0.256	■		
X4GK2503015-0265LN-FG	0,15 0.006	2,65 0.104	19,0 0.748	25,43 1.001	20,39 0.803	6,5 0.256	■		
X4GK2503005-0050LN-FG	0,05 0.002	0,5 0.020	19,0 0.748	25,44 1.001	20,40 0.803	2,6 0.102			■
X4GK2503005-0100LN-FG	0,05 0.002	1,0 0.039	19,0 0.748	25,44 1.001	20,40 0.803	4,3 0.169			■
X4GK2503010-0150LN-FG	0,1 0.004	1,5 0.059	19,0 0.748	25,44 1.001	20,40 0.803	6,5 0.256			■

General ISO Turning

Steadyline®

MDT

Mini-Shaft™

Grooving

Parting-off

X4

Adapters
Clamping units

Accessories and
Spare parts

Workpiece
materials

General ISO Turning	Designation	RE	CW	LIG	INSL	S	CDXI*	Grades Coated		
		mm <i>Inch</i>	mm <i>Inch</i>	mm <i>Inch</i>	mm <i>Inch</i>	mm <i>Inch</i>	mm <i>Inch</i>	CP500	CP600	TGH1050
	X4GK2503010-0200LN-FG	0,1 <i>0.004</i>	2,0 <i>0.079</i>	19,0 <i>0.748</i>	25,44 <i>1.001</i>	20,40 <i>0.803</i>	6,5 <i>0.256</i>			■
X4GK2503015-0250LN-FG	0,15 <i>0.006</i>	2,5 <i>0.098</i>	19,0 <i>0.748</i>	25,44 <i>1.001</i>	20,40 <i>0.803</i>	6,5 <i>0.256</i>			■	
X4GK2503015-0300LN-FG	0,15 <i>0.006</i>	3,0 <i>0.118</i>	19,0 <i>0.748</i>	25,44 <i>1.001</i>	20,40 <i>0.803</i>	6,5 <i>0.256</i>			■	

Steadyline®

MDT

Mini-Shaft™

Grooving

Parting-off

X4

Adapters
Clamping units

Accessories and
Spare parts

Workpiece
materials

X4GK

* Maximum cutting depth CDXI is limited relative to workpiece diameter to avoid contact between workpiece and toolholder, see guide page(s) 943

Right-hand insert (RN/RR/RL) must only be used with Right-hand holder

Left-hand insert (LN/LR/LL) must only be used with Left-hand holder

Please check availability at www.secotools.com / Seco Online Store

Tolerances:
CW = ±0,025
CDXI = ±0,1
S = ±0,025
RE = ±0,03

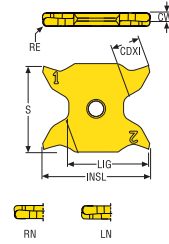

RN-R



LN-R



Designation	RE	CW	LIG	INSL	S	CDXI*	Grades Coated		
							CP600	CP600	TGH1050
X4GK2503M0-0100RN-R	0,5 0.020	1,0 0.039	19,0 0.748	25,24 0.994	20,38 0.802	4,3 0.169	■		
X4GK2503M0-0120RN-R	0,6 0.024	1,2 0.047	19,0 0.748	25,29 0.996	20,37 0.802	4,3 0.169	■		
X4GK2503M0-0150RN-R	0,75 0.030	1,5 0.059	19,0 0.748	25,36 0.998	20,37 0.802	6,5 0.256	■		
X4GK2503M0-0200RN-R	1,0 0.039	2,0 0.079	19,0 0.748	25,39 1.000	20,36 0.801	6,5 0.256	■		
X4GK2503M0-0300RN-R	1,5 0.059	3,0 0.118	19,0 0.748	25,37 0.999	20,34 0.801	6,5 0.256	■		
X4GK2503M0-0100LN-R	0,5 0.020	1,0 0.039	19,0 0.748	25,24 0.994	20,38 0.802	4,3 0.169	■		
X4GK2503M0-0120LN-R	0,6 0.024	1,2 0.047	19,0 0.748	25,29 0.996	20,37 0.802	4,3 0.169	■		
X4GK2503M0-0150LN-R	0,75 0.030	1,5 0.059	19,0 0.748	25,36 0.998	20,37 0.802	6,5 0.256	■		
X4GK2503M0-0200LN-R	1,0 0.039	2,0 0.079	19,0 0.748	25,39 1.000	20,36 0.801	6,5 0.256	■		
X4GK2503M0-0300LN-R	1,5 0.059	3,0 0.118	19,0 0.748	25,37 0.999	20,34 0.801	6,5 0.256	■		

General / ISO Turning

Steadyline®

MDT

Mini-Shaft™

Grooving

Parting-off

X4

Adapters
Clamping units

Accessories and
Spare parts

Workpiece
materials

General ISO Turning

X4G

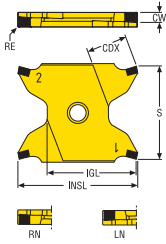

Tolerances:
 CW = $\pm 0,025/0,001$
 CDXI = $\pm 0,1/0,004$
 S = $\pm 0,025/0,001$
 RE = $\pm 0,03/0,0012$

* Maximum cutting depth CDXI is limited relative to workpiece diameter to avoid contact between workpiece and toolholder, see guide page(s) 943

Right-hand insert (RN/RR/RL) must only be used with Right-hand holder

Left-hand insert (LN/LR/LL) must only be used with Left-hand holder

Please check availability at www.secotools.com / Seco Online Store

Steadyline®

RN-D



LN-D



MDT

Designation	RE		CW		LIG		INSL		S		CDXI*		Grades Coated
	mm	Inch	mm	Inch	mm	Inch	mm	Inch	mm	Inch	mm	Inch	CBN200
X4G2503015S-0215RN-D	0,15	0.006	2,15	0.085	19,0	0.748	25,00	0.984	20,36	0.802	6,5	0.256	■
X4G2503015S-0215LN-D	0,15	0.006	2,15	0.085	19,0	0.748	25,00	0.984	20,36	0.802	6,5	0.256	■

Mini-Shaft™

Grooving

Parting-off

X4

Adapters Clamping units

Accessories and Spare parts

Workpiece materials



Adapters

Seco offers a comprehensive product range of stationary adapters that can be used in horizontal or vertical lathes, machining centers and sliding-head and multi-tasking machines. These products can be used in spindles, turrets, sub-spindles and half-turrets.

- Shank tools adapters offer a very popular connection for square-shank turning toolholders.
- Boring bars adapters offer several flexible tool sizes in a wide diameter range for rough and fine boring.

General ISO Turning

C-ASHA-...JETI – Metric/ Inch

Steadyline®

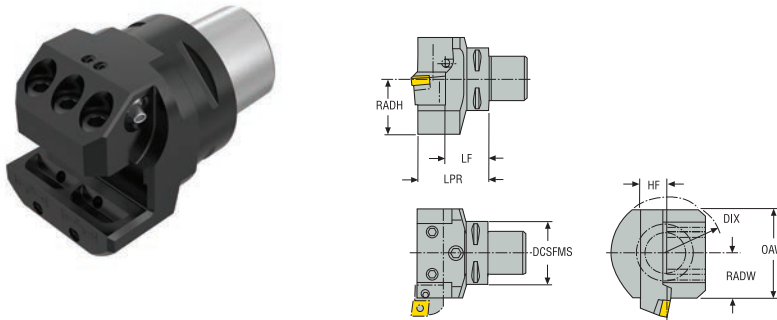

MDT

- * Max coolant pressure may need additional spare part according to machine side limitation
- For more information on Jetstream Tooling® (High pressure coolant) and accessories, please see page(s) 38, 85-89, 1002
- CTMS = Seco-Capto™ size
- Please check availability at www.secotools.com / Seco Online Store

Mini-Shaft™

Designation	Item number	CTMS	DCSFMS		LF	HF	LPR	OAW	RADW	RADH	CP*	Weight										
			mm	Inch									mm	Inch								
C5-ASHA-065-20JETI	03142918	C5	50,0	1.969	85,0	3.346	45,0	1.772	20,0	0.787	65,0	2.559	64,0	2.520	32,0	1.260	37,0	1.457	150,0	2175.6	1,5	3.310
C6-ASHA-070-20JETI	03142926	C6	63,0	2.480	85,0	3.346	50,0	1.969	20,0	0.787	70,0	2.756	64,0	2.520	32,0	1.260	37,0	1.457	150,0	2175.6	1,9	4.190
C6-ASHA-080-25JETI	03142927	C6	63,0	2.480	100,0	3.937	55,0	2.165	25,0	0.984	80,0	3.150	76,0	2.992	38,0	1.496	46,0	1.811	150,0	2175.6	2,5	5.510
C8-ASHA-075-25JETI	03142941	C8	80,0	3.150	103,0	4.055	50,0	1.969	25,0	0.984	75,0	2.953	80,0	3.150	38,0	1.496	46,0	1.811	150,0	2175.6	3,1	6.830

Grooving

Parting-off

Spare Parts

For size	Clamp screw	Coolant nozzle
Cx-ASHA	T6SS12X20	CN8

X4

Adapters Clamping units

Accessories and Spare parts

Workpiece materials

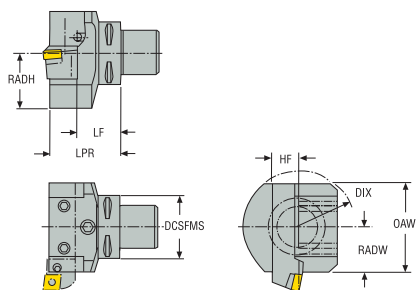

C.-ASHA-..JETI – Inch



- * Max coolant pressure may need additional spare part according to machine side limitation
- For more information on Jetstream Tooling® (High pressure coolant) and accessories, please see page(s) 38, 85-89, 1002
- CTMS = Seco-Capto™ size
- Please check availability at www.secotools.com / Seco Online Store

Designation	Item number	CTMS	DCSFMS	DIX	LF	HF	LPR	OAW	RADW	RADH	CP*	Weight
			Inch	Inch	Inch	Inch	Inch	Inch	Inch	Inch	psi	lbs
C5-ASHA-065-12AJETI	10008680	C5	1.969	3.346	1.809	0.750	2.559	2.520	1.260	1.457	2175.6	3.310
C6-ASHA-070-12AJETI	10008679	C6	2.480	3.346	2.006	0.750	2.756	2.520	1.260	1.457	2175.6	4.190
C6-ASHA-080-16AJETI	10008681	C6	2.480	3.937	2.150	1.000	3.150	2.992	1.496	1.811	2175.6	5.510

Spare Parts

For size	Clamp screw	Nozzle
C.-ASHA	 T6SS12X20	 CN8

- General ISO Turning
- Steadyline®
- MDT
- Mini-Shaft™
- Grooving
- Parting-off
- X4
- Adapters Clamping units
- Accessories and Spare parts
- Workpiece materials

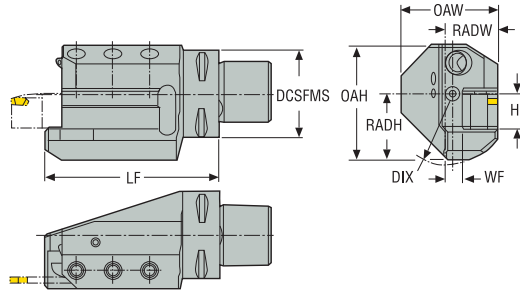

C-ASHR/L-...JETI – Metric/ Inch



- * Max coolant pressure may need additional spare part according to machine side limitation
- For more information on Jetstream Tooling® (High pressure coolant) and accessories, please see page(s) 38, 85-89, 1002
- CTMS = Seco-Capto™ size
- Right-hand version shown
- Please check availability at www.secotools.com / Seco Online Store

Designation	Item number	CTMS	DCSFMS	DIX	LF	HF	WF	OAH	RADW	RADH	CP*	Weight
			mm Inch	mm Inch	mm Inch	mm Inch	mm Inch	mm Inch	mm Inch	mm Inch	bar psi	kg lbs
C5-ASHR-095-20JETI	03142924	C5	50,0 1.969	85,0 3.346	95,0 3.740	20,0 0.787	10,0 0.394	69,0 2.717	30,0 1.181	37,0 1.457	150,0 2175.6	1,7 3.750
C5-ASHL-095-20JETI	03142921	C5	50,0 1.969	85,0 3.346	95,0 3.740	20,0 0.787	10,0 0.394	69,0 2.717	30,0 1.181	37,0 1.457	150,0 2175.6	1,7 3.750
C6-ASHR-105-20JETI	03142932	C6	63,0 2.480	85,0 3.346	105,0 4.134	20,0 0.787	10,0 0.394	69,0 2.717	30,0 1.181	37,0 1.457	150,0 2175.6	2,4 5.290
C6-ASHR-122-25JETI	03142933	C6	63,0 2.480	100,0 3.937	122,0 4.803	25,0 0.984	13,0 0.512	78,0 3.071	38,0 1.496	46,0 1.811	150,0 2175.6	3,0 6.610
C6-ASHL-105-20JETI	03142928	C6	63,0 2.480	85,0 3.346	105,0 4.134	20,0 0.787	10,0 0.394	69,0 2.717	30,0 1.181	37,0 1.457	150,0 2175.6	2,4 5.290
C6-ASHL-122-25JETI	03142929	C6	63,0 2.480	100,0 3.937	122,0 4.803	25,0 0.984	13,0 0.512	78,0 3.071	38,0 1.496	46,0 1.811	150,0 2175.6	3,0 6.610
C8-ASHR-122-25JETI	03142943	C8	80,0 3.150	103,0 4.055	122,0 4.803	25,0 0.984	15,0 0.591	86,0 3.386	40,0 1.575	46,0 1.811	150,0 2175.6	3,9 8.600
C8-ASHL-122-25JETI	03142942	C8	80,0 3.150	103,0 4.055	122,0 4.803	25,0 0.984	15,0 0.591	86,0 3.386	40,0 1.575	46,0 1.811	150,0 2175.6	3,8 8.380

Spare Parts

For size	Clamp screw	Coolant nozzle
...-095, -105	 T6SS10X20	 CN8
...-122	T6SS12X20	CN8

General ISO Turning
Steadyline®
MDT
Mini-Shaft™
Grooving
Parting-off
X4
Adapters Clamping units
Accessories and Spare parts
Workpiece materials

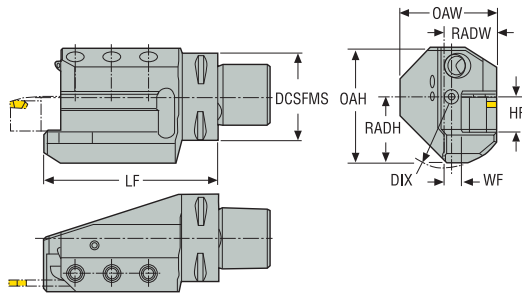

C.-ASHR/L-..JETI – Inch



- * Max coolant pressure may need additional spare part according to machine side limitation
- For more information on Jetstream Tooling® (High pressure coolant) and accessories, please see page(s) 38, 85-89, 1002
- CTMS = Seco-Capto™ size
- Right-hand version shown
- Please check availability at www.secotools.com / Seco Online Store

Designation	Item number	CTMS	DCSFMS	DIX	LF	HF	WF	OAH	RADW	RADH	CP*	Weight
			Inch	Inch	Inch	Inch	Inch	Inch	Inch	Inch	psi	lbs
C5-ASHR-095-12AJETI	10008687	C5	1.969	3.346	3.740	0.750	0.431	2.717	1.181	1.457	2175.6	3.750
C5-ASHL-095-12AJETI	10008688	C5	1.969	3.346	3.740	0.750	0.431	2.717	1.181	1.457	2175.6	3.750
C6-ASHR-105-12AJETI	10008685	C6	2.480	3.346	4.134	0.750	0.431	2.717	1.260	1.457	2175.6	5.290
C6-ASHR-122-16AJETI	10008689	C6	2.480	3.937	4.803	1.000	0.496	3.071	1.496	1.811	2175.6	6.610
C6-ASHL-105-12AJETI	10008686	C6	2.480	3.346	4.134	0.750	0.431	2.717	1.260	1.457	2175.6	5.290
C6-ASHL-122-16AJETI	10008690	C6	2.480	3.937	4.803	1.000	0.496	3.071	1.496	1.811	2175.6	6.610

Spare Parts

For size	Clamp screw	Nozzle
...-095/105	 T6SS10X20	 CN8
...-122	T6SS12X20	CN8

General / ISO Turning

Steadyline®

MDT

Mini-Shaft™

Grooving

Parting-off

X4

Adapters
Clamping units

Accessories and
Spare parts

Workpiece
materials

General ISO Turning

C.-ASHS-..JETI – Metric/ Inch

Steadyline®

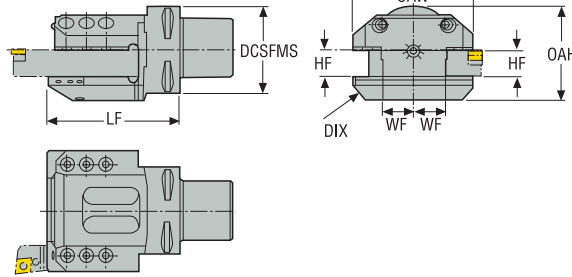

MDT



- * Max coolant pressure may need additional spare part according to machine side limitation
- For more information on Jetstream Tooling® (High pressure coolant) and accessories, please see page(s) 38, 85-89, 1002
- CTMS = Seco-Capto™ size
- Please check availability at www.secotools.com / Seco Online Store

Mini-Shaft™

Designation	Item number	CTMS	DCSFMS	DIX	LF	HF	WF	OAW	OAH	RADW	CP*	Weight
			mm Inch	mm Inch	mm Inch	mm Inch	mm Inch	mm Inch	mm Inch	mm Inch	bar psi	kg lbs
C6-ASHS-122-25JETI	03142936	C6	63,0 2.480	114,0 4.488	122,0 4.803	25,0 0.984	20,0 0.787	90,0 3.543	78,0 3.071	45,0 1.772	150,0 2175.6	4,2 9.260
C8-ASHS-122-25JETI	03142944	C8	80,0 3.150	128,0 5.039	122,0 4.803	25,0 0.984	30,0 1.181	110,0 4.331	78,0 3.071	55,0 2.165	150,0 2175.6	4,8 10.580

Grooving

Spare Parts

For size	Clamp screw	Coolant nozzle
Cx-ASHS	 T6SS12X20	 CN8

Parting-off

X4

Adapters
Clamping units

Accessories and
Spare parts

Workpiece
materials

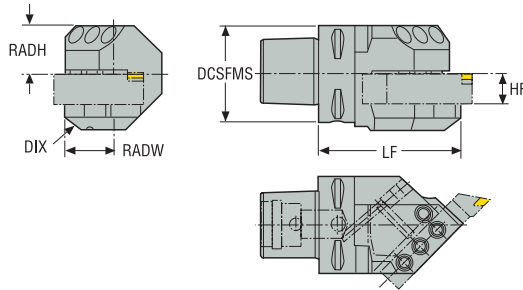

C-ASHR/L-..JETI – Metric / Inch



- * Max coolant pressure may need additional spare part according to machine side limitation
- For more information on Jetstream Tooling® (High pressure coolant) and accessories, please see page(s) 38, 85-89, 1002
- CTMS = Seco-Capto™ size
- Right-hand version shown
- Please check availability at www.secotools.com / Seco Online Store

Designation	Item number	CTMS	DCSFMS		DIX	LF	HF	RADW	RADH	CP*	Weight							
			mm	Inch														
C5-ASHR45-085-20JETI	03142925	C5	50,0	1.969	85,0	3.346	85,0	3.346	20,0	0.787	32,0	1.260	37,0	1.457	150,0	2175.6	1,6	3.530
C5-ASHL45-085-20JETI	03142923	C5	50,0	1.969	85,0	3.346	85,0	3.346	20,0	0.787	32,0	1.260	37,0	1.457	150,0	2175.6	1,6	3.530
C6-ASHR45-095-20JETI	03142934	C6	63,0	2.480	85,0	3.346	95,0	3.740	20,0	0.787	32,0	1.260	37,0	1.457	150,0	2175.6	2,1	4.630
C6-ASHR45-114-25JETI	03142935	C6	63,0	2.480	100,0	3.937	114,0	4.488	25,0	0.984	36,0	1.417	46,0	1.811	150,0	2175.6	2,9	6.390
C6-ASHL45-095-20JETI	03142930	C6	63,0	2.480	85,0	3.346	95,0	3.740	20,0	0.787	32,0	1.260	37,0	1.457	150,0	2175.6	2,1	4.630
C6-ASHL45-114-25JETI	03142931	C6	63,0	2.480	100,0	3.937	114,0	4.488	25,0	0.984	36,0	1.417	46,0	1.811	150,0	2175.6	2,9	6.390

Spare Parts

For size	Clamp screw	Coolant nozzle
...-085, -095	 T6SS10X20	 CN8
...114	T6SS12X20	CN8

General / ISO Turning

Steadyline®

MDT

Mini-Shaft™

Grooving

Parting-off

X4

Adapters
Clamping units

Accessories and
Spare parts

Workpiece
materials

General ISO Turning

Steadyline®

MDT

Mini-Shaft™

Grooving

Parting-off

X4

Adapters
Clamping units

Accessories and
Spare parts

Workpiece
materials

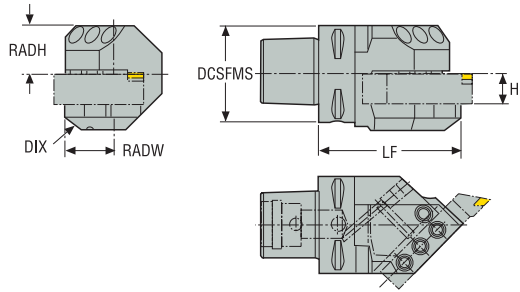

C-ASHR/L-...JETI – Inch



- * Max coolant pressure may need additional spare part according to machine side limitation
- For more information on Jetstream Tooling® (High pressure coolant) and accessories, please see page(s) 38, 85-89, 1002
- CTMS = Seco-Capto™ size
- Right-hand version shown
- Please check availability at www.secotools.com / Seco Online Store

Designation	Item number	CTMS	DCSFMS	DIX	LF	HF	RADW	RADH	CP*	Weight
			Inch	Inch	Inch	Inch	Inch	Inch	psi	lbs
C5-ASHR45-085-12AJETI	10008693	C5	1.969	3.346	3.346	0.750	1.260	1.457	2175.6	3.530
C5-ASHL45-085-12AJETI	10008694	C5	1.969	3.346	3.346	0.750	1.260	1.457	2175.6	3.530
C6-ASHR45-095-12AJETI	10008691	C6	2.480	3.346	3.740	0.750	1.260	1.457	2175.6	5.290
C6-ASHR45-114-16AJETI	10008682	C6	2.480	3.937	4.488	1.000	1.417	1.811	2175.6	6.390
C6-ASHL45-095-12AJETI	10008692	C6	2.480	3.346	3.740	0.750	1.260	1.457	2175.6	5.290
C6-ASHL45-114-16AJETI	10008683	C6	2.480	3.937	4.488	1.000	1.417	1.811	2175.6	6.390

Spare Parts

For size	Clamp screw	Nozzle
...-085/095	 T6SS10X20	 CN8
...-114	T6SS12X20	CN8

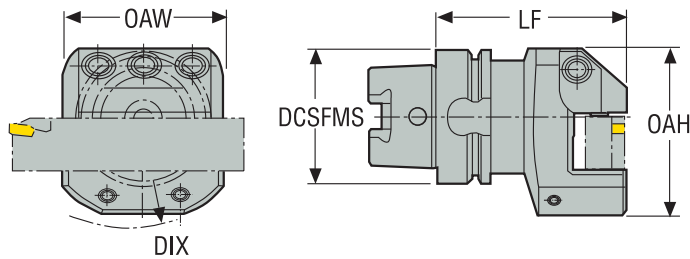

E9364-ASHA-..JETI – Metric/ Inch



- * Max coolant pressure may need additional spare part according to machine side limitation
- For more information on Jetstream Tooling® (High pressure coolant) and accessories, please see page(s) 38, 85-89, 1002
- Please check availability at www.secotools.com / Seco Online Store

Designation	Item number	CTMS	DCSFMS	DIX	LF	HF	LPR	OAW	OAH	RADW	RADH	CP*	Weight
			mm Inch	mm Inch	mm Inch	mm Inch	mm Inch	mm Inch	mm Inch	mm Inch	mm Inch	bar psi	kg lbs
E9364-ASHA-090-25JETI	03142937	HSK-T63	63,0 2.480	100,0 3.937	65,0 2.559	25,0 0.984	90,0 3.543	76,0 2.992	78,0 3.071	38,0 1.496	46,0 1.811	150,0 2175.6	2,3 5.070

Spare Parts

For size	Clamp screw	Coolant nozzle
E9364-ASHA	 T6SS12X20	 CN8

General ISO Turning

Steadyline®

MDT

Mini-Shaft™

Grooving

Parting-off

X4

Adapters
Clamping units

Accessories and
Spare parts

Workpiece
materials

General ISO Turning

E9364-ASHA-..JETI – Inch

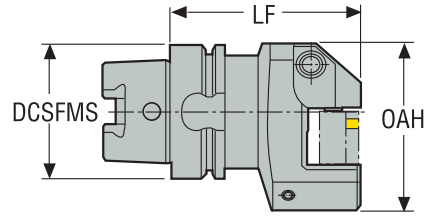
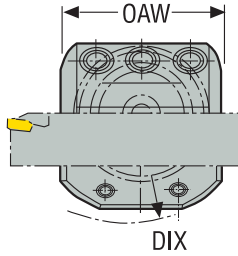

Steadyline®

MDT



- * Max coolant pressure may need additional spare part according to machine side limitation
- For more information on Jetstream Tooling® (High pressure coolant) and accessories, please see page(s) 38, 85-89, 1002
- Please check availability at www.secotools.com / Seco Online Store

Mini-Shaft™

Designation	Item number	CTMS	DCSFMS	DIX	LF	HF	LPR	OAW	OAH	RADW	RADH	CP*	Weight
			Inch	Inch	Inch	Inch	Inch	Inch	Inch	Inch	Inch	psi	lbs
E9364-ASHA-090-16AJETI	10008684	HSK-T63	2.478	3.937	2.543	1.000	3.543	2.992	3.071	1.496	1.811	2175.6	5.070

Spare Parts

Grooving

For size	Clamp screw	Nozzle
E9364	 T6SS12X20	 CN8

Parting-off

X4

Adapters Clamping units

Accessories and Spare parts

Workpiece materials

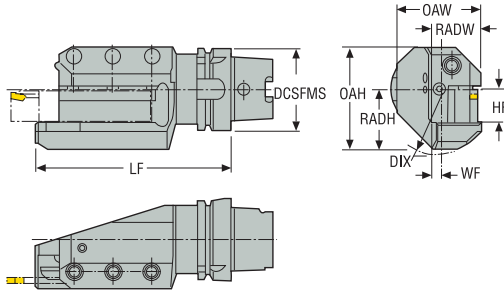

E9364-ASHR/L-..JETI – Metric / Inch



- * Max coolant pressure may need additional spare part according to machine side limitation
- For more information on Jetstream Tooling® (High pressure coolant) and accessories, please see page(s) 38, 85-89, 1002
- Right-hand version shown
- Please check availability at www.secotools.com / Seco Online Store

Designation	Item number	CTMS	DCSFMS	DIX	LF	HF	OAW	OAH	RADW	RADH	CP*	Weight
E9364-ASHR-132-25JETI	03142939	HSK-T63	63,0 2.480	100,0 3.937	132,0 5.197	25,0 0.984	69,47 2.735	78,0 3.071	48,0 1.890	46,0 1.811	150,0 2175.6	2,8 6.170
E9364-ASHL-132-25JETI	03142938	HSK-T63	63,0 2.480	100,0 3.937	132,0 5.197	25,0 0.984	69,47 2.735	78,0 3.071	48,0 1.890	46,0 1.811	150,0 2175.6	2,8 6.170

Spare Parts

For size	Clamp screw	Coolant nozzle
E9364-ASHR/L	 T6SS12X20	 CN8

General / ISO Turning

Steadyline®

MDT

Mini-Shaft™

Grooving

Parting-off

X4

Adapters
Clamping units

Accessories and
Spare parts

Workpiece
materials

ASHA-R/L-.-JETI – Metric/ Inch

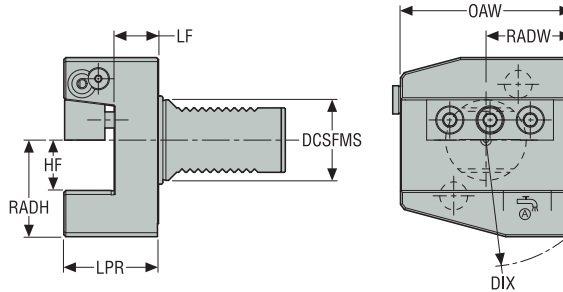

- Face mounting turret position
- Right combined design B1 and B4
- Left combined design B2 and B3
- Double sided VDI shank grinding
- Right-hand version shown
- CTMS = VDI size
- * Max coolant pressure
- For more information on Jetstream Tooling® (High pressure coolant) and accessories, please see page(s) 38, 85-89, 1002
- Please check availability at www.secotools.com / Seco Online Store

Designation	Item number	CTMS	DCSFMS	DIX	LF	HF	LPR	OAW	RADW	RADH	CP*	Weight
			mm Inch	mm Inch	mm Inch	mm Inch	mm Inch	mm Inch	mm Inch	mm Inch	bar psi	kg lbs
ASHA-R-VDI30-20-JETI	03200452	VDI30	30,0 1.181	103,0 4.055	22,0 0.866	20,0 0.787	42,0 1.654	70,0 2.756	35,0 1.378	38,0 1.496	80,0 1160.3	1,6 3.530
ASHA-L-VDI30-20-JETI	03200455	VDI30	30,0 1.181	103,0 4.055	22,0 0.866	20,0 0.787	42,0 1.654	70,0 2.756	35,0 1.378	38,0 1.496	80,0 1160.3	1,6 3.530
ASHA-R-VDI40-25-JETI	03200453	VDI40	40,0 1.575	128,0 5.039	22,0 0.866	25,0 0.984	47,0 1.850	85,0 3.346	42,5 1.673	48,0 1.890	80,0 1160.3	2,6 5.730
ASHA-L-VDI40-25-JETI	03200456	VDI40	40,0 1.575	128,0 5.039	22,0 0.866	25,0 0.984	47,0 1.850	85,0 3.346	42,5 1.673	48,0 1.890	80,0 1160.3	2,6 5.730
ASHA-R-VDI50-25-JETI	03200454	VDI50	50,0 1.969	142,0 5.591	30,0 1.181	25,0 0.984	55,0 2.165	100,0 3.937	50,0 1.969	50,0 1.969	80,0 1160.3	4,4 9.700
ASHA-L-VDI50-25-JETI	03200457	VDI50	50,0 1.969	142,0 5.591	30,0 1.181	25,0 0.984	55,0 2.165	100,0 3.937	50,0 1.969	50,0 1.969	80,0 1160.3	4,4 9.700

Spare Parts

For size	Clamp screw	Coolant adapter	Nozzle	O-ring	Screw	Screw 2	Washer	Wedge
VDI30	MC6S6X25	JET-CFP1/8	CN14	5641005-134	MF6S5X12	MC6S6X14	JET-CS1013	5431115-07
VDI40	MC6S8X25	JET-CFP1/8	CN14	5641005-135	MF6S5X12	MC6S8X16	JET-CS1013	5431115-08
R-VDI50	MC6S8X30	JET-CFP1/8	CN13	5641001-119	MF6S6X12	MC6S8X16	JET-CS1013	5431115-08
L-VDI50	MC6S8X30	JET-CFP1/8	CN13	5641001-119	MF6S6X12	MC6S8X16	JET-CS1013	5431115-08



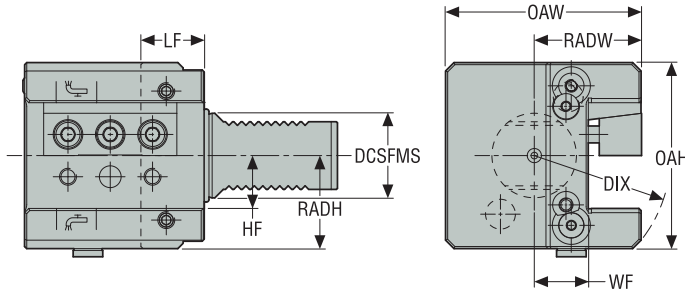





ASHN-...-JETI – Metric / Inch

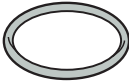

- Star mounting turret position
- Neutral combined design C1, C2, C3, C4
- Double sided VDI shank grinding
- Neutral version shown
- CTMS = VDI size
- * Max coolant pressure
- For more information on Jetstream Tooling® (High pressure coolant) and accessories, please see page(s) 38, 85-89, 1002
- Please check availability at www.secotools.com / Seco Online Store

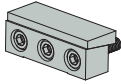
Designation	Item number	CTMS	DCSFMS		DIX		LF		HF		OAW		OAH		RADW		RADH		CP*	Weight		
			mm	Inch	mm	Inch	mm	Inch	mm	Inch	mm	Inch	mm	Inch	mm	Inch	mm	Inch			bar	psi
ASHN-VDI30-20-JETI	03200450	VDI30	30,0	1.181	65,0	2.559	22,0	0.866	20,0	0.787	85,5	3.366	70,0	2.756	55,5	2.185	35,0	1.378	80,0	1160.3	2,0	4.410
ASHN-VDI40-25-JETI	03200451	VDI40	40,0	1.575	64,0	2.520	30,0	1.181	25,0	0.984	92,5	3.642	88,0	3.465	50,5	1.988	44,0	1.732	80,0	1160.3	3,5	7.720

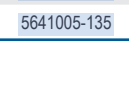
Spare Parts

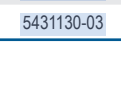
For size	Coolant adapter	Nozzle	O-ring	Screw	Washer	Wedge set
..-20	 JET-CFP1/8	 CN14	 5641005-134	 MF6S5X12	 JET-CS1013	 5431130-02
..-25	 JET-CFP1/8	 CN13	 5641005-135	 MF6S6X12	 JET-CS1013	 5431130-03

General / ISO Turning

Steadyline®

MDT

Mini-Shaft™

Grooving

Parting-off

X4

Adapters
Clamping units

Accessories and
Spare parts

Workpiece
materials

General ISO Turning

C.-ASHA – Metric/ Inch

Steadyline®

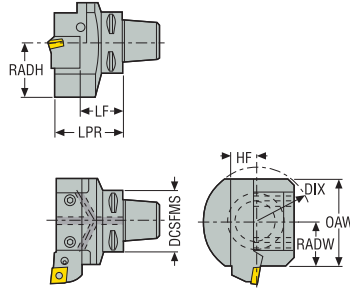

MDT

- Neutral version shown
- CTMS = Seco-Capto™ size
- * Max coolant pressure
- Please check availability at www.secotools.com / Seco Online Store

Mini-Shaft™

Designation	Item number	CTMS	DCSFMS	DIX	LF	HF	LPR	OAW	RADW	RADH	CP*	Weight
			mm Inch	mm Inch	mm Inch	mm Inch	mm Inch	mm Inch	mm Inch	mm Inch	bar psi	kg lbs
C6-ASHA-50071-32M	02690506	C6	63,0 2.480	130,0 5.118	45,0 1.772	32,0 1.260	71,0 2.795	100,0 3.937	50,0 1.969	65,0 2.559	80,0 1160.3	3,4 7.500

Grooving

Spare Parts

For size	Bolt	Circlip	Coolant nozzle	O-ring
C6	VB23	SGH1510	CN9	ORING-9X2

Parting-off

X4

Adapters
Clamping units

Accessories and
Spare parts

Workpiece
materials

C-ASHA – Inch

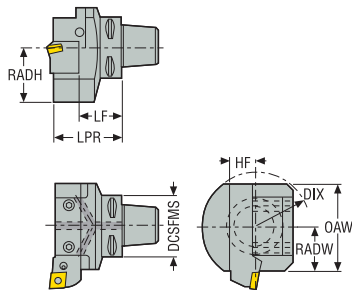

- Neutral version shown
- CTMS = Seco-Capto™ size
- * Max coolant pressure
- Please check availability at www.secotools.com / Seco Online Store

Designation	Item number	CTMS	DCSFMS	DIX	LF	HF	LPR	OAW	RADW	RADH	CP*	Weight
			Inch	Inch	Inch	Inch	Inch	Inch	Inch	Inch	psi	lbs
C8-ASHA-55085-20-A	02594533	C8	3.150	5.591	2.087	1.250	3.346	4.331	2.165	2.559	1160.3	10.360

Spare Parts

For size	Nozzle
	
C8	CN9

General ISO Turning

Steadyline®

MDT

Mini-Shaft™

Grooving

Parting-off

X4

Adapters
Clamping units

Accessories and
Spare parts

Workpiece
materials

General ISO Turning

C.-ASHR/L – Metric/ Inch

Steadyline®

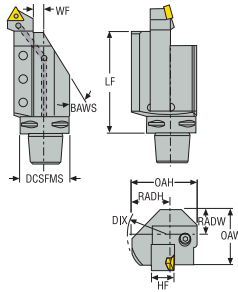

MDT

- Right-hand version shown
- CTMS = Seco-Capto™ size
- * Max coolant pressure
- Please check availability at www.secotools.com / Seco Online Store

Mini-Shaft™

Designation	Item number	CTMS	DCSFMS	DIX	LF	HF	WF	OAW	OAH	RADW	RADH	BAWS°	CP*	Weight
			mm Inch	mm Inch	mm Inch	mm Inch	mm Inch	mm Inch	mm Inch	mm Inch	mm Inch		bar psi	kg lbs
C8-ASHR-40140-32	02548913	C8	80,0 3.150	110,0 4.331	140,0 5.512	32,0 1.260	8,0 0.315	80,0 3.150	85,0 3.346	40,0 1.575	55,0 2.165	30,0	80,0 1160.3	5,2 11.460
C8-ASHL-40140-32	02545526	C8	80,0 3.150	110,0 4.331	140,0 5.512	32,0 1.260	8,0 0.315	80,0 3.150	85,0 3.346	40,0 1.575	55,0 2.165	30,0	80,0 1160.3	5,5 12.130

Grooving

Spare Parts

For size	Coolant nozzle
C8	 CN10

Parting-off

X4

Adapters
Clamping units

Accessories and
Spare parts

Workpiece
materials

C.-ASHS – Metric/ Inch

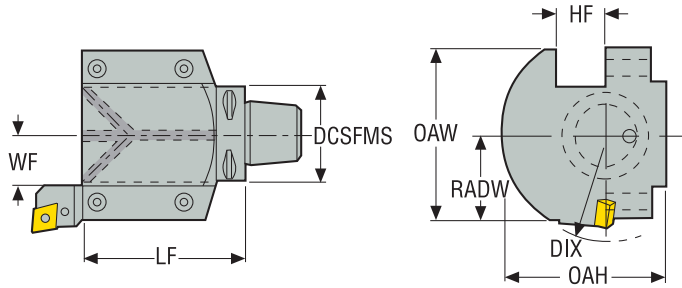

- Neutral version shown
- CTMS = Seco-Capto™ size
- * Max coolant pressure
- Please check availability at www.secotools.com / Seco Online Store

Designation	Item number	CTMS	DCSFMS	DIX	LF	HF	WF	OAW	OAH	RADW	CP*	Weight
			mm Inch	mm Inch	mm Inch	mm Inch	mm Inch	mm Inch	mm Inch	mm Inch	bar psi	kg lbs
C6-ASHS-58115-32	00024834	C6	63,0 2.480	140,0 5.512	115,0 4.528	32,0 1.260	33,0 1.299	116,0 4.567	110,0 4.331	58,0 2.283	80,0 1160.3	7,4 16.310

Spare Parts

For size	Coolant nozzle
C6	CN9



General ISO Turning

Steadyline®

MDT

Mini-Shaft™

Grooving

Parting-off

X4

Adapters
Clamping units

Accessories and
Spare parts

Workpiece
materials

General ISO Turning

C.-ASHR/L – Metric/ Inch

Steadyline®

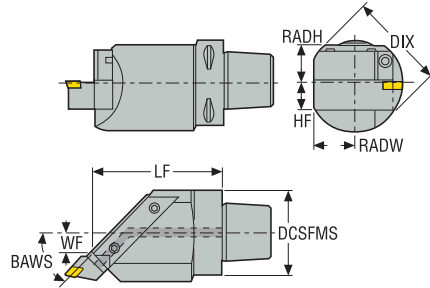

MDT

- Right-hand version shown
- CTMS = Seco-Capto™ size
- * Max coolant pressure
- Please check availability at www.secotools.com / Seco Online Store

Mini-Shaft™

Designation	Item number	CTMS	DCSFMS	DIX	LF	HF	RADW	RADH	BAWS°	CP*	Weight
			mm Inch	mm Inch	mm Inch	mm Inch	mm Inch	mm Inch		bar psi	kg lbs
C8-ASHR45-50135-32	02548915	C8	80,0 3.150	140,0 5.512	115,0 4.528	32,0 1.260	45,0 1.772	40,0 1.575	45,0	80,0 1160.3	6,6 14.550
C8-ASHL45-50135-32	02590034	C8	80,0 3.150	140,0 5.512	135,0 5.315	32,0 1.260	45,0 1.772	40,0 1.575	45,0	80,0 1160.3	6,6 14.550

Grooving

Spare Parts

For size	Coolant nozzle
C8	 CN9

Parting-off

X4

Adapters
Clamping units

Accessories and
Spare parts

Workpiece
materials

C.-ASHR/L – Metric/ Inch

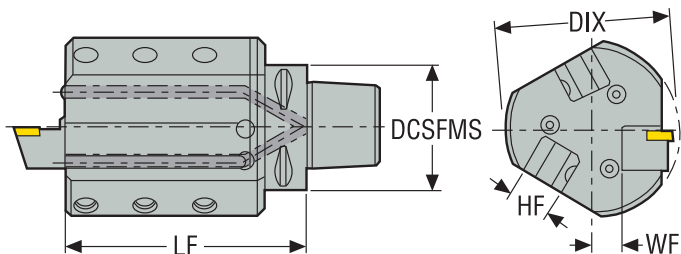

- Right-hand version shown
- CTMS = Seco-Capto™ size
- * Max coolant pressure
- Please check availability at www.secotools.com / Seco Online Store

Designation	Item number	CTMS	DCSFMS		LF		HF		WF		CP*	Weight				
			mm	Inch	mm	Inch	mm	Inch	mm	Inch			mm	Inch		
C5-ASHR3-36123-20	02590021	C5	50,0	1.969	90,0	3.543	123,0	4.843	20,0	0.787	16,0	0.630	80,0	1160.3	3,7	8.160
C6-ASHR3-36125-20	02437460	C6	63,0	2.480	90,0	3.543	125,0	4.921	20,0	0.787	16,0	0.630	80,0	1160.3	3,8	8.380
C6-ASHL3-36125-20	02204131	C6	63,0	2.480	90,0	3.543	125,0	4.921	20,0	0.787	16,0	0.630	80,0	1160.3	3,8	8.380

Spare Parts

For size	Coolant nozzle
C5 / C6	 CN2

General ISO Turning
Steadyline®
MDT
Mini-Shaft™
Grooving
Parting-off
X4
Adapters
Clamping units
Accessories and Spare parts
Workpiece materials

General ISO Turning

C.-ASHR/L – Inch

Steadyline®

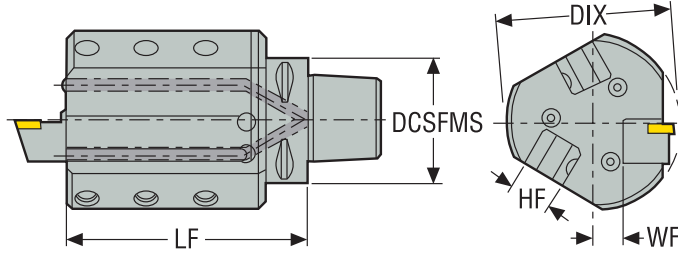

MDT

- Right-hand version shown
- CTMS = Seco-Capto™ size
- * Max coolant pressure
- Please check availability at www.secotools.com / Seco Online Store

Mini-Shaft™

Designation	Item number	CTMS	DCSFMS	DIX	LF	HF	WF	CP*	Weight
			Inch	Inch	Inch	Inch	Inch	psi	lbs
C6-ASHR3-36125-12-A	02594601	C6	2.480	3.543	4.843	0.750	0.614	1160.3	3.310

Spare Parts

Grooving

For size	Nozzle
C6	 CN9

Parting-off

X4

Adapters
Clamping units

Accessories and
Spare parts

Workpiece
materials

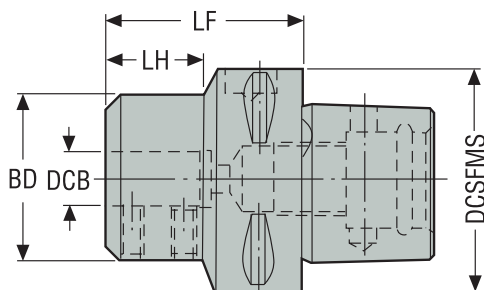

C.-131 – Metric/ Inch



- CTMS = Seco-Capto™ size
- * Max coolant pressure
- Please check availability at www.secotools.com / Seco Online Store

Designation	Item number	CTMS	DCSFMS		DCB		BD		LF	LH	CP*	Weight				
			mm	Inch	mm	Inch	mm	Inch					mm	Inch		
C3-131-00035-10	00094677	C3	32,0	1.260	10,0	0.394	36,0	1.417	35,0	1.378	20,0	0.787	80,0	1160.3	0,24	0.530
C3-131-00040-12	00094678	C3	32,0	1.260	12,0	0.472	36,0	1.417	40,0	1.575	24,0	0.945	80,0	1160.3	0,29	0.640
C4-131-00040-10	00072826	C4	40,0	1.575	10,0	0.394	36,0	1.417	40,0	1.575	19,0	0.748	80,0	1160.3	0,39	0.860
C4-131-00045-12	00094679	C4	40,0	1.575	12,0	0.472	36,0	1.417	45,0	1.772	24,0	0.945	80,0	1160.3	0,42	0.930
C4-131-00050-16	00094680	C4	40,0	1.575	16,0	0.630	36,0	1.417	50,0	1.969	29,0	1.142	80,0	1160.3	0,43	0.950
C5-131-00045-10	00094681	C5	50,0	1.969	10,0	0.394	36,0	1.417	45,0	1.772	21,0	0.827	80,0	1160.3	0,62	1.370
C5-131-00045-12	00094682	C5	50,0	1.969	12,0	0.472	36,0	1.417	45,0	1.772	22,5	0.886	80,0	1160.3	0,6	1.320
C5-131-00055-16	00094683	C5	50,0	1.969	16,0	0.630	36,0	1.417	55,0	2.165	31,0	1.220	80,0	1160.3	0,65	1.430

Spare Parts

For size	Key	Screw
...-10	 3SMS795	 951C0610
...-12	3SMS795	951C0610
...-16	4SMS795	951C0810

General ISO Turning
Steadyline®
MDT
Mini-Shaft™
Grooving
Parting-off
X4
Adapters Clamping units
Accessories and Spare parts
Workpiece materials

General ISO Turning

Steadyline®

MDT

Mini-Shaft™

Grooving

Parting-off

X4

Adapters Clamping units

Accessories and Spare parts

Workpiece materials

C.-131 – Metric/ Inch

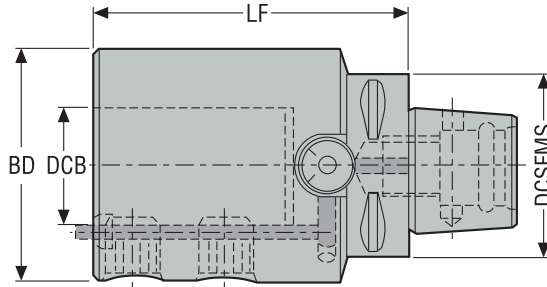

- Sleeves, see page(s) 983
- CTMS = Seco-Capto™ size
- * Max coolant pressure
- Please check availability at www.secotools.com / Seco Online Store

Designation	Item number	CTMS	DCSFMS	DCB	BD	LF	CP*	Weight
			mm Inch	mm Inch	mm Inch	mm Inch	bar psi	kg lbs
C5-131-00100-25	02466940	C5	50,0 1.969	25,0 0.984	63,0 2.480	100,0 3.937	80,0 1160.3	2,1 4.630
C6-131-00098-25	02435607	C6	63,0 2.480	25,0 0.984	63,0 2.480	98,0 3.858	80,0 1160.3	2,0 4.410
C8-131-00098-25	02590011	C8	80,0 3.150	25,0 0.984	63,0 2.480	98,0 3.858	80,0 1160.3	3,4 7.500
C8-131-00112-40	02590013	C8	80,0 3.150	40,0 1.575	80,0 3.150	112,0 4.409	80,0 1160.3	4,2 9.260

Spare Parts

For size	Locking key	Locking screw
C5...-25	8SMS795	LH16020
C6...-25	8SMS795	LH16020
C8...-25	8SMS795	LH16020
C8...-40	10SMS795	LH20020

132N – Metric/ Inch

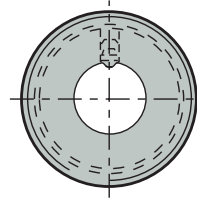
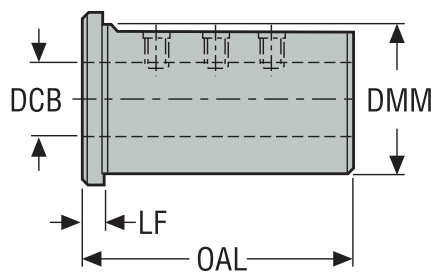

- Holders, see page(s) 982
- Please check availability at www.secotools.com / Seco Online Store

Designation	Item number	DMM	DCB	LF	OAL	Weight
		mm Inch	mm Inch	mm Inch	mm Inch	kg lbs
132N-2506	02583296	25,0 0.984	6,0 0.236	5,0 0.197	61,0 2.402	0,1 0.220
132N-2508	02583300	25,0 0.984	8,0 0.315	5,0 0.197	61,0 2.402	0,3 0.660
132N-2510	02583301	25,0 0.984	10,0 0.394	5,0 0.197	61,0 2.402	0,3 0.660
132N-2512	02583302	25,0 0.984	12,0 0.472	5,0 0.197	61,0 2.402	0,3 0.660
132N-2516	02435623	25,0 0.984	16,0 0.630	5,0 0.197	61,0 2.402	0,1 0.220
132N-2520	02435624	25,0 0.984	20,0 0.787	5,0 0.197	61,0 2.402	0,1 0.220
132N-4020	02533449	40,0 1.575	20,0 0.787	5,0 0.197	75,0 2.953	0,1 0.220
132N-4025	02583362	40,0 1.575	25,0 0.984	5,0 0.197	75,0 2.953	0,5 1.100
132N-4032	02435628	40,0 1.575	32,0 1.260	5,0 0.197	75,0 2.953	0,3 0.660

Spare Parts

For size	Key	Screw
-2506	3SMS795	P6SS6X8
-2508	4SMS795	P6SS8X8
-2510	4SMS795	P6SS8X6
-2512	4SMS795	P6SS8X6
-2516/-2520/4032	-	-
-4020	5SMS795	P6SS10X8
-4025	5SMS795	P6SS10X8

General ISO Turning

Steadyline®

MDT

Mini-Shaft™

Grooving

Parting-off

X4

Adapters Clamping units

Accessories and Spare parts

Workpiece materials

General ISO Turning

131- and SL Holders and sleeves for boring tools – Metric/ Inch

Steadyline®

MDT

Mini-Shaft™

Grooving

Parting-off

X4

Adapters
Clamping units

Accessories and
Spare parts

Workpiece
materials

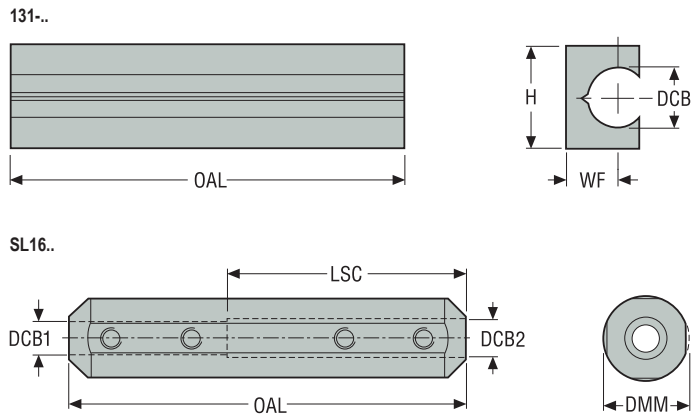

• Please check availability at www.secotools.com / Seco Online Store

Designation	Item number	DMM	DCB	DCB1	DCB2	WF	H	OAL	LSC	Weight
		mm Inch	mm Inch	mm Inch	mm Inch	mm Inch	mm Inch	mm Inch	mm Inch	kg lbs
131-408	75003148	-	8,0 0.315	-	-	-	13,0 0.512	110,0 4.331	-	0,111 0.240
131-410	75003149	-	10,0 0.394	-	-	-	16,0 0.630	110,0 4.331	-	0,13 0.290
131-412	75003150	-	12,0 0.472	-	-	-	20,0 0.787	110,0 4.331	-	0,158 0.350
131-416	75003151	-	16,0 0.630	-	-	-	25,0 0.984	110,0 4.331	-	0,214 0.470
131-420	75003152	-	20,0 0.787	-	-	-	32,0 1.260	110,0 4.331	-	0,328 0.720
SL160506	00026511	16,0 0.630	-	5,0 0.197	6,0 0.236	-	-	75,0 2.953	45,0 1.772	0,1 0.220
SL160608	00040435	16,0 0.630	-	6,0 0.236	8,0 0.315	-	-	75,0 2.953	45,0 1.772	0,09 0.200

Spare Parts

For size	Locking screw
131-	-
SL16..	P6SS4X4

Accessories

For size	Locking key
131-	-
SL16..	2SMS795



Seco-Capto™ clamping units

Seco-Capto™ clamping units provide a flexible and modular system, whereby the same adapters can be used across different machines and tool assemblies can be built with extensions. The Seco-Capto systems offers high torque transmission, rigidity and accuracy with a strong, self-centering joint within 2 µm. Seco-Capto back ends are available on rotating tools, as well as stationary tools for turning, boring, threading and grooving applications.

- Type 2085 with straight-shank-type machine-side connection
- Type 2000/3000 with cylindrical machine-side connection.
- VDI Clamping units
- Type 2090 clamping units adapters provide a specific mounting system.

- General ISO Turning
- Steadyline®
- MDT
- Mini-Shaft™
- Grooving
- Parting-off
- X4
- Adapters Clamping units
- Accessories and Spare parts
- Workpiece materials

Selection of VDI clamping unit

	Internal/Toolholder Right Clamping unit LC	External/Toolholder Right Clamping unit RC	Internal/Toolholder Right Clamping unit RC	External/Toolholder Right Clamping unit LC
	Internal/Toolholder Right	External/Toolholder Right	Internal/Toolholder Right	External/Toolholder Right

Note: The polygon socket has to be rotated 180°

Selection of VDI clamping unit

	Internal/Toolholder Left Clamping unit LC	External/Toolholder Left Clamping unit RC	Internal/Toolholder Left Clamping unit RC	External/Toolholder Left Clamping unit LC
	Internal/Toolholder Left	External/Toolholder Left	Internal/Toolholder Left	External/Toolholder Left

Note: The polygon socket has to be rotated 180°

Selection of clamping unit 2000/3000/2085

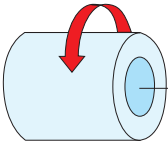
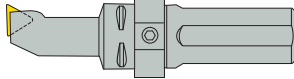
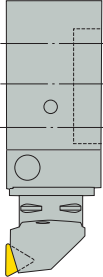
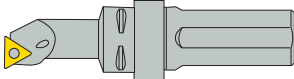
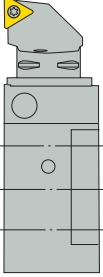
	<p>Internal/Toolholder Right NC 2000/3000 Upside-down</p> 	<p>External/Toolholder Left Clamping unit RC</p> 
		
	<p>Internal/Toolholder Right NC 2000/3000</p>	<p>Internal/Toolholder Right NC 2000/3000</p>

- General ISO Turning
- Steadyline®
- MDT
- Mini-Shaft™
- Grooving
- Parting-off
- X4
- Adapters Clamping units
- Accessories and Spare parts
- Workpiece materials

Selection of VDI clamping unit

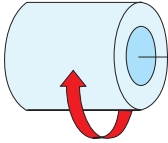
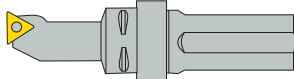
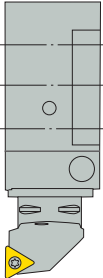
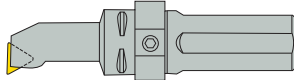
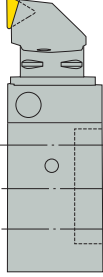
	<p>Internal/Toolholder Left NC 2000/3000</p> 	<p>External/Toolholder Left LC 2085</p> 
		
	<p>Internal/Toolholder Left NC 2000/3000 Upside-down</p>	<p>External/Toolholder Left LC 2085 Upside-down</p>

2000 = cylindrical type with drawbar, 3000 = cylindrical type with screw, 2085 = shank type.

General ISO Turning

Clamping unit 2090 for special applications

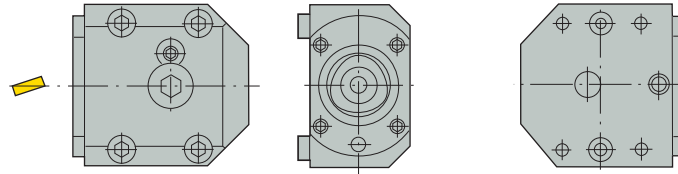

Steadyline®

Design instruction for application of clamping unit RC/LC 2090

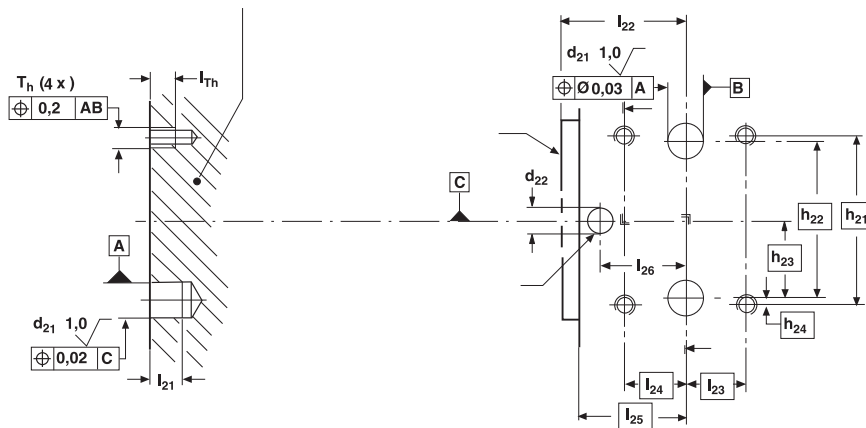

1. Material hardness = 270 HB min
2. Front of clamping unit
3. Coolant outlet

MDT

Mini-Shaft™

Grooving

Parting-off

Seco-Capto™ size	Designation	Dimensions in mm/inch													
		d ₂₁ H7	d ₂₂	h ₂₁	h ₂₂	h ₂₃	h ₂₄	l ₂₁ min	l ₂₂	l ₂₃	l ₂₄	l ₂₅	l ₂₆	l _{Th} min	T _h
C3	C3-R/LC2090-19039M	12 0.470	5 0.200	42 1.654	39 1.535	19,5 0.768	1,5 0.060	8,5 0.335	39 1.535	19,0 0.748	19,0 0.748	33,5 1.319	28 1.102	7,5 0.295	M6
C4	C4-R/LC2090-24043A	16 0.630	7 0.280	60 2.362	5 0.200	27,5 1.083	2,5 0.098	11,0 0.433	43 1.693	19,0 0.748	19,0 0.748	36,5 1.437	30 1.180	11,0 0.433	M8
C5	C5-R/LC2090-32048A	20 0.787	7 0.280	70 2.756	62 2.441	31,0 1.220	4,0 0.160	12,0 0.470	48 1.890	21,0 0.827	21,0 0.827	39,5 1.555	33 1.299	13,0 0.512	M10
C6	C6-R/LC2090-42060	25 0.984	10 0.400	82 3.228	71 2.795	35,5 1.398	5,5 0.217	20,0 0.787	60 2.362	24,5 0.965	24,5 0.965	50,0 1.969	41 1.614	12,0 0.470	M10
C8	C8-R/LC2090-50088	32 1.260	11 0.433	110 4.331	92 3.622	46,0 1.811	9,0 0.354	20,0 0.787	88 3.465	43,0 1.693	43,0 1.693	76,0 2.992	63 2.480	14,5 0.571	M12

Toolholders

A large range of Seco-Capto™ toolholders is available:

- For external and internal turning with negative inserts.
- For external and internal turning with positive inserts.
- For external and internal turning with MDT inserts.
- For external and internal threading.

For selection of toolholder use the guidelines for conventional tools.

Adapters
Clamping units

Accessories and
Spare parts

Workpiece
materials

Cover plug

A cover plug should always be used to protect the ground surfaces of the connecting sleeve from dirt or damage to the clamping units when they do not have a cutting unit inserted.

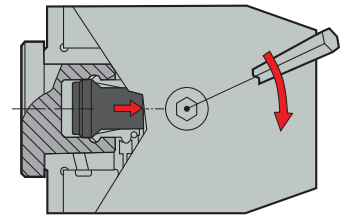

General ISO Turning

Clamping force

In order to obtain the necessary clamping force (F) the clamping unit should be tightened to the torque value (Mv) as recommended in the table below.

Torque Mv	
Size	Nm
C3	35
C4	50
C5	70
C6	90
C8	130

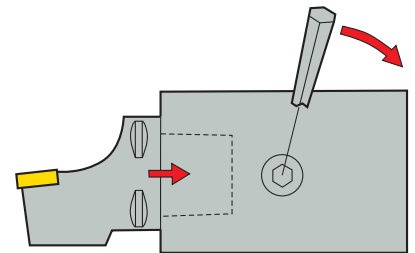

Steadyline®

MDT

Mini-Shaft™

Turning the cutting tool 180°

If the entire clamping unit has to be rotated 180°, the polygon socket should be rotated 180°.

1. Loosen the screws (2).
2. Dismantle the polygon socket. Use the special tool as described on page(s) 1003 (ordered separately).
3. Move the guiding pin to the opposite side of the clamping unit.
4. Rotate the polygon socket 180° and reassemble. Tap carefully with a plastic mallet.

Grooving

Parting-off

Lubrication

All manual clamping units are lubricated with BP Energrease ACS-2 prior to delivery (Alternative MOBIL Temp Shc 32 or STATOIL Beacon 325). The lubrication should be checked every six months. New grease can be applied via the cam.

1. Remove the screw (1).
2. Assemble grease nipple 5692 012-01.
3. Pump in grease with grease gun until it begins to seep out around the key handle at the cam.
4. Remove grease nipple.
5. Replace screw (1) into the cam.

Note: Clamping unit must be clamped during lubrication.

X4

Adapters
Clamping units

Accessories and
Spare parts

Workpiece
materials

General ISO Turning

Straight shank type – Metric/ Inch

Steadyline®

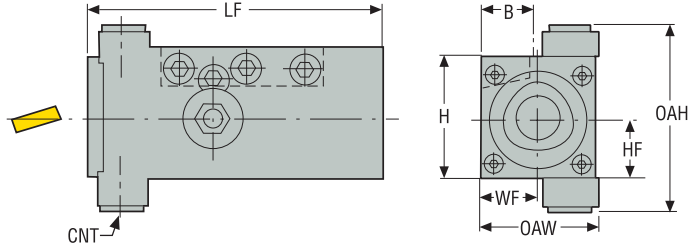

MDT

- How to select Clamping unit, see page(s) 987
- Spare Parts, see page(s) 997
- Right-hand version shown
- * Max coolant pressure
- Please check availability at www.secotools.com / Seco Online Store

Mini-Shaft™

Designation	Item number	CTWS	Shank	LF	HF	WF	H	B	OAW	OAH	CNT	CP*	Weight
				mm Inch	mm Inch	mm Inch	mm Inch	mm Inch	mm Inch	mm Inch		mm Inch	bar psi
C3-LC2085-4038M	00093954	C3	2020	95,0 3.740	20,0 0.787	19,0 0.748	40,0 1.575	20,0 0.787	38,0 1.496	62,0 2.441	G1/8	80,0 1160.3	1,05 2.310
C3-RC2085-4038M	00093966	C3	2020	95,0 3.740	20,0 0.787	19,0 0.748	40,0 1.575	20,0 0.787	38,0 1.496	62,0 2.441	G1/8	80,0 1160.3	1,05 2.310
C4-LC2085-5048	00093977	C4	2525	125,0 4.921	25,0 0.984	24,0 0.945	50,0 1.969	25,0 0.984	48,0 1.890	58,0 2.283	G1/8	80,0 1160.3	2,1 4.630
C4-RC2085-5048	75079661	C4	2525	125,0 4.921	25,0 0.984	24,0 0.945	50,0 1.969	25,0 0.984	48,0 1.890	58,0 2.283	G1/8	80,0 1160.3	2,1 4.630
C5-LC2085-6464	00093997	C5	3232	145,0 5.709	32,0 1.260	32,0 1.260	64,0 2.520	32,0 1.260	64,0 2.520	72,0 2.835	G1/8	80,0 1160.3	4,3 9.480
C5-RC2085-6464	75069018	C5	3232	145,0 5.709	32,0 1.260	32,0 1.260	64,0 2.520	32,0 1.260	64,0 2.520	72,0 2.835	G1/8	80,0 1160.3	4,1 9.040

Grooving

Parting-off

X4

Adapters
Clamping units

Accessories and
Spare parts

Workpiece
materials

Cylindrical type – Metric / Inch

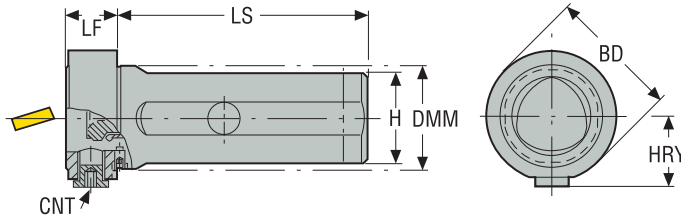

- How to select Clamping unit, see page(s) 987
- Spare Parts, see page(s) 998
- Type 2000 locking with drawbar and segment
- Type 3000 locking with centre bolt
- Neutral version shown
- * Max coolant pressure
- Please check availability at www.secotools.com / Seco Online Store

Designation	Item number	CTWS	DMM	BD	LF	LS	HRY	H	CNT	CP*	Weight
			mm Inch	mm Inch	mm Inch	mm Inch	mm Inch	mm Inch		bar psi	kg lbs
C3-NC2000-08018-32	00094035	C3	32,0 1.260	45,5 1.791	18,0 0.709	80,0 3.150	26,0 1.024	30,0 1.181	G1/8	80,0 1160.3	0,62 1.370
C3-NC3000-08018-32	00094037	C3	32,0 1.260	45,5 1.791	18,0 0.709	80,0 3.150	26,0 1.024	30,0 1.181	G1/8	80,0 1160.3	0,64 1.410
C3-NC3000-10018-40	00093956	C3	32,0 1.260	45,5 1.791	18,0 0.709	100,0 3.937	26,0 1.024	37,0 1.457	G1/8	80,0 1160.3	1,11 2.450
C4-NC2000-10020-40	00094039	C4	40,0 1.575	51,5 2.028	20,0 0.787	100,0 3.937	28,0 1.102	37,0 1.457	G1/8	80,0 1160.3	1,07 2.360
C5-NC2000-12024-50	00094045	C5	50,0 1.969	61,5 2.421	24,0 0.945	120,0 4.724	33,0 1.299	47,0 1.850	G1/8	80,0 1160.3	1,99 4.390
C4-NC3000-10020-40	00094041	C4	40,0 1.575	51,5 2.028	20,0 0.787	100,0 3.937	28,0 1.102	37,0 1.457	G1/8	80,0 1160.3	1,09 2.400
C5-NC3000-12024-50	00090845	C5	50,0 1.969	61,5 2.421	24,0 0.945	120,0 4.724	33,0 1.299	47,0 1.850	G1/8	80,0 1160.3	1,84 4.060

General / ISO Turning

Steadyline®

MDT

Mini-Shaft™

Grooving

Parting-off

X4

Adapters
Clamping units

Accessories and
Spare parts

Workpiece
materials

General ISO Turning

Cylindrical type – Inch

Steadyline®

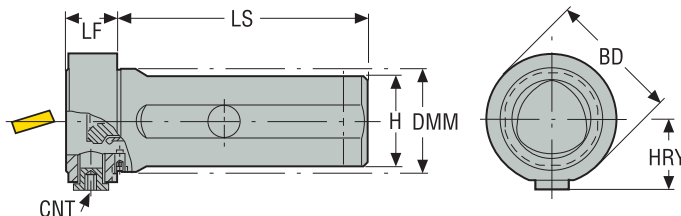

MDT

- How to select Clamping unit, see page(s) 987
- Spare Parts, see page(s) 998
- Type 2000 locking with drawbar and segment
- Type 3000 locking with centre bolt
- Neutral version shown
- * Max coolant pressure
- Please check availability at www.secotools.com / Seco Online Store

Mini-Shaft™

Designation	Item number	CTWS	DMM	BD	LF	LS	HRY	H	CNT	CP*	Weight
			Inch	Inch	Inch	Inch	Inch	Inch		psi	lbs
C4-NC2000-10020-A24	00077739	C4	1.500	2.028	0.787	3.937	1.024	1.457	G1/8	1160.3	2.140
C4-NC2000-12020-A32	00077741	C4	2.000	2.028	0.787	4.724	1.024	1.850	G1/8	1160.3	3.570
C5-NC2000-12024-A32	00077743	C5	2.000	2.421	0.945	4.724	1.220	1.850	G1/8	1160.3	4.610
C4-NC3000-10020-A24	00077745	C4	1.500	2.028	0.787	3.937	1.024	1.378	G1/8	1160.3	2.250
C4-NC3000-12020-A32	00077749	C4	2.000	2.028	0.787	4.724	1.024	1.850	G1/8	1160.3	4.230
C5-NC3000-12024-A32	00077757	C5	2.000	2.421	0.945	4.724	1.220	1.850	G1/8	1160.3	4.670

Grooving

Parting-off

X4

Adapters
Clamping units

Accessories and
Spare parts

Workpiece
materials

VDI type angled DIN69880 – Metric / Inch

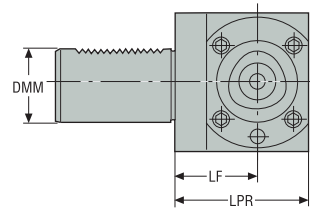
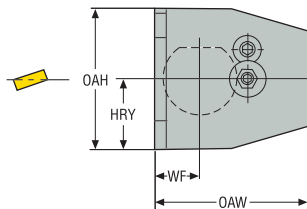

- How to select Clamping unit, see page(s) 986
- Spare Parts, see page(s) 999
- Right-hand version shown
- * Max coolant pressure
- Please check availability at www.secotools.com / Seco Online Store

Designation	Item number	CTWS	DMM	LF	WF	HRV	LPR	OAW	OAH	CP*	Weight
			mm Inch	mm Inch	mm Inch	mm Inch	mm Inch	mm Inch	mm Inch	bar psi	kg lbs
C3-RC2030-41020M	00093958	C3	30,0 1.181	41,0 1.614	20,0 0.787	30,0 1.181	60,0 2.362	74,0 2.913	57,0 2.244	80,0 1160.3	1,9 4.190
C3-LC2030-41020M	00093946	C3	30,0 1.181	41,0 1.614	20,0 0.787	30,0 1.181	60,0 2.362	74,0 2.913	57,0 2.244	80,0 1160.3	1,9 4.190
C3-RC2030-41030M	00093959	C3	30,0 1.181	41,0 1.614	30,0 1.181	30,0 1.181	60,0 2.362	73,0 2.874	57,0 2.244	80,0 1160.3	2,0 4.410
C3-LC2030-41030M	00093947	C3	30,0 1.181	41,0 1.614	30,0 1.181	30,0 1.181	60,0 2.362	73,0 2.874	57,0 2.244	80,0 1160.3	2,0 4.410
C4-RC2040-51030M	75065642	C4	40,0 1.575	51,0 2.008	30,0 1.181	38,0 1.496	75,0 2.953	86,0 3.386	75,0 2.953	80,0 1160.3	3,8 8.380
C4-LC2040-51030M	00093969	C4	40,0 1.575	51,0 2.008	30,0 1.181	38,0 1.496	75,0 2.953	86,0 3.386	75,0 2.953	80,0 1160.3	3,8 8.380
C4-RC2040-51040M	00093982	C4	40,0 1.575	51,0 2.008	40,0 1.575	38,0 1.496	75,0 2.953	86,0 3.386	75,0 2.953	80,0 1160.3	4,0 8.820
C4-LC2040-51040M	00093970	C4	40,0 1.575	51,0 2.008	40,0 1.575	38,0 1.496	75,0 2.953	86,0 3.386	75,0 2.953	80,0 1160.3	4,0 8.820
C5-RC2040-53030M	00094003	C5	40,0 1.575	53,0 2.087	30,0 1.181	41,0 1.614	85,0 3.346	99,0 3.898	82,0 3.228	80,0 1160.3	4,9 10.800
C5-LC2040-53030M	00093986	C5	40,0 1.575	53,0 2.087	30,0 1.181	41,0 1.614	85,0 3.346	99,0 3.898	82,0 3.228	80,0 1160.3	4,9 10.800
C5-RC2040-53040M	00090846	C5	40,0 1.575	53,0 2.087	40,0 1.575	41,0 1.614	85,0 3.346	99,0 3.898	82,0 3.228	80,0 1160.3	5,0 11.020
C5-LC2040-53040M	00093987	C5	40,0 1.575	53,0 2.087	40,0 1.575	41,0 1.614	85,0 3.346	99,0 3.898	82,0 3.228	80,0 1160.3	5,0 11.020
C5-RC2050-53030M	00094005	C5	50,0 1.969	53,0 2.087	30,0 1.181	43,0 1.693	85,0 3.346	99,0 3.898	86,0 3.386	80,0 1160.3	5,8 12.790
C5-LC2050-53030M	00093989	C5	50,0 1.969	53,0 2.087	30,0 1.181	43,0 1.693	85,0 3.346	99,0 3.898	86,0 3.386	80,0 1160.3	5,8 12.790
C5-RC2050-53040M	00092175	C3	50,0 1.969	53,0 2.087	40,0 1.575	43,0 1.693	85,0 3.346	99,0 3.898	86,0 3.386	80,0 1160.3	6,0 13.230
C5-LC2050-53040M	00093990	C5	50,0 1.969	53,0 2.087	40,0 1.575	43,0 1.693	85,0 3.346	99,0 3.898	86,0 3.386	80,0 1160.3	6,0 13.230
C5-RC2060-43040M	00094011	C5	60,0 2.362	43,0 1.693	40,0 1.575	53,0 2.087	75,0 2.953	99,0 3.898	94,0 3.701	80,0 1160.3	6,8 14.990
C5-LC2060-43040M	00093993	C5	60,0 2.362	43,0 1.693	40,0 1.575	53,0 2.087	75,0 2.953	99,0 3.898	94,0 3.701	80,0 1160.3	6,8 14.990

General / ISO Turning

Steadyline®

MDT

Mini-Shaft™

Grooving

Parting-off

X4

Adapters
Clamping units

Accessories and
Spare parts

Workpiece
materials

General ISO Turning	Designation	Item number	CTWS	DMM	LF	WF	HRY	LPR	OAW	OAH	CP*	Weight
				mm <i>Inch</i>	mm <i>Inch</i>	mm <i>Inch</i>	mm <i>Inch</i>	mm <i>Inch</i>	mm <i>Inch</i>	mm <i>Inch</i>	bar <i>psi</i>	kg <i>lbs</i>
	C6-RC2060-53040	00094025	C6	60,0 2.362	53,0 2.087	40,0 1.575	53,0 2.087	95,0 3.740	122,0 4.803	105,0 4.134	80,0 1160.3	9,6 21.160
C6-LC2060-53040	00094018	C6	60,0 2.362	53,0 2.087	40,0 1.575	53,0 2.087	95,0 3.740	122,0 4.803	105,0 4.134	80,0 1160.3	9,6 21.160	

Steadyline®

MDT

Mini-Shaft™

Grooving

Parting-off

X4

Adapters
Clamping units

Accessories and
Spare parts

Workpiece
materials

VDI type straight DIN69880 – Metric/ Inch

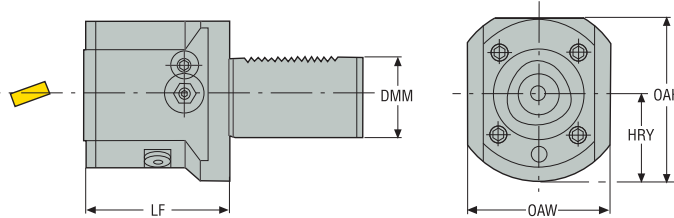

- How to select Clamping unit, see page(s) 986
- Spare Parts, see page(s) 1000
- Right-hand version shown
- * Max coolant pressure
- Please check availability at www.secotools.com / Seco Online Store

Designation	Item number	CTWS	DMM	LF	HRY	OAW	OAH	CP*	Weight
			mm Inch	mm Inch	mm Inch	mm Inch	mm Inch	bar psi	kg lbs
C3-RC2030-00060M	00093957	C3	30,0 1.181	60,0 2.362	34,0 1.339	50,0 1.969	61,0 2.402	80,0 1160.3	1,1 2.430
C3-LC2030-00060M	00093945	C3	30,0 1.181	60,0 2.362	34,0 1.339	50,0 1.969	61,0 2.402	80,0 1160.3	1,1 2.430
C4-RC2040-00075M	75069447	C4	40,0 1.575	75,0 2.953	41,0 1.614	75,0 2.953	75,0 2.953	80,0 1160.3	2,2 4.850
C4-LC2040-00075M	75065641	C4	40,0 1.575	75,0 2.953	41,0 1.614	75,0 2.953	75,0 2.953	80,0 1160.3	2,2 4.850
C5-RC2040-00085M	00094001	C5	40,0 1.575	85,0 3.346	41,0 1.614	75,0 2.953	82,0 3.228	80,0 1160.3	3,3 7.280
C5-LC2040-00085M	75079704	C5	40,0 1.575	85,0 3.346	41,0 1.614	75,0 2.953	82,0 3.228	80,0 1160.3	3,3 7.280
C4-RC2050-00065M	75068269	C4	50,0 1.969	65,0 2.559	49,0 1.929	70,0 2.756	83,0 3.268	80,0 1160.3	2,6 5.730
C4-LC2050-00065M	00093972	C4	50,0 1.969	65,0 2.559	49,0 1.929	70,0 2.756	83,0 3.268	80,0 1160.3	2,6 5.730
C5-RC2060-00075M	00094007	C5	60,0 2.362	75,0 2.953	58,0 2.283	80,0 3.150	100,0 3.937	80,0 1160.3	5,2 11.460
C5-LC2060-00075M	00093992	C5	60,0 2.362	75,0 2.953	58,0 2.283	80,0 3.150	100,0 3.937	80,0 1160.3	5,2 11.460
C5-RC2050-00085M	00091790	C5	50,0 1.969	85,0 3.346	49,0 1.929	83,0 3.268	90,0 3.543	80,0 1160.3	4,2 9.260
C5-LC2050-00085M	00093988	C5	50,0 1.969	85,0 3.346	49,0 1.929	83,0 3.268	90,0 3.543	80,0 1160.3	4,2 8.820
C6-RC2060-00095	00094024	C6	60,0 2.362	95,0 3.740	58,0 2.283	84,0 3.307	111,0 4.370	80,0 1160.3	6,9 15.210
C6-LC2060-00095	00094017	C6	60,0 2.362	95,0 3.740	58,0 2.283	84,0 3.307	111,0 4.370	80,0 1160.3	6,9 15.210

General / ISO Turning

Steadyline®

MDT

Mini-Shaft™

Grooving

Parting-off

X4

Adapters
Clamping units

Accessories and
Spare parts

Workpiece
materials

General ISO Turning

For special applications – Metric/ Inch

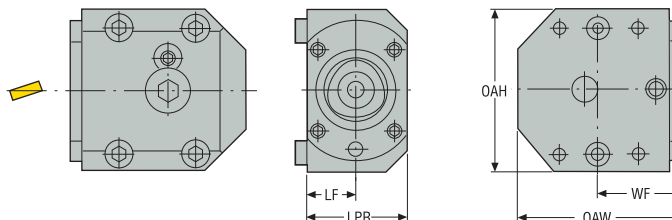
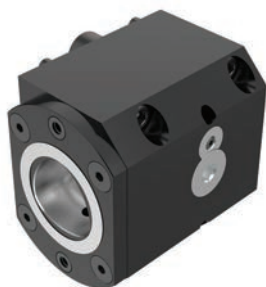

Steadyline®

MDT

- Design instruction, see page(s) 988
- Spare Parts, see page(s) 1001
- Right-hand version shown
- * Max coolant pressure
- Please check availability at www.secotools.com / Seco Online Store

Mini-Shaft™

Designation	Item number	CTWS	LF	WF	LPR	OAW	OAH	CP*	Weight
			mm Inch	mm Inch	mm Inch	mm Inch	mm Inch		
C3-RC2090-19039M	00093967	C3	19,0 0.748	39,0 1.535	38,0 1.496	73,0 2.874	54,0 2.126	80,0 1160.3	1,0 2.200
C3-LC2090-19039M	00093955	C3	19,0 0.748	39,0 1.535	38,0 1.496	73,0 2.874	54,0 2.126	80,0 1160.3	1,0 2.200
C4-RC2090-24043A	00093984	C4	24,0 0.945	43,0 1.693	48,0 1.890	86,0 3.386	77,0 3.031	80,0 1160.3	1,9 4.190
C4-LC2090-24043A	00093978	C4	24,0 0.945	43,0 1.693	48,0 1.890	86,0 3.386	77,0 3.031	80,0 1160.3	1,9 4.190
C5-RC2090-32048A	00094015	C5	32,0 1.260	48,0 1.890	64,0 2.520	100,0 3.937	92,0 3.622	80,0 1160.3	3,5 7.720
C5-LC2090-32048A	00093998	C5	32,0 1.260	48,0 1.890	64,0 2.520	100,0 3.937	92,0 3.622	80,0 1160.3	3,5 7.720
C6-RC2090-42060	00094029	C6	42,0 1.654	60,0 2.362	84,0 3.307	122,0 4.803	105,0 4.134	80,0 1160.3	6,5 14.330
C6-LC2090-42060	00094021	C6	42,0 1.654	60,0 2.362	84,0 3.307	122,0 4.803	105,0 4.134	80,0 1160.3	6,5 14.330
C8-RC2090-50088	00094034	C8	50,0 1.969	88,0 3.465	100,0 3.937	146,0 5.748	133,0 5.236	80,0 1160.3	12,4 27.340
C8-LC2090-50088	00094032	C8	50,0 1.969	88,0 3.465	100,0 3.937	146,0 5.748	133,0 5.236	80,0 1160.3	12,4 27.340

Grooving

Parting-off

X4

Adapters
Clamping units

Accessories and
Spare parts

Workpiece
materials

Manually operated clamping units

Type 2085

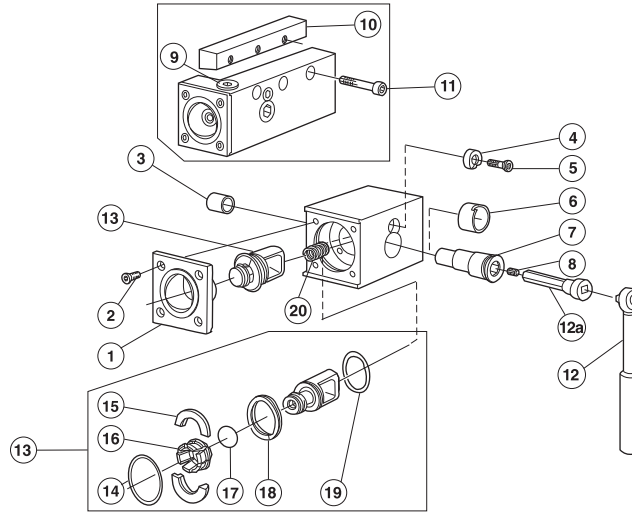

Size	1 Sleeve	2 Screw (4x)	3 Bushing	4 Locking washer	5 Screw
C3	5252015-01	416.1-834	3823010-101	5541030-01	416.1-834
C4	5252015-02	5513020-26	3823010-122	5541030-02	416.1-834
C5	5252015-03	5513020-14	3823010-162	5541030-03	5513020-14
Size	6 Bushing	7 Cam shaft	8 Screw	9 Plug	10 Metric wedge
C3	5638022-01	5333025-01	3214010-355	3611005-180	5431115-01
C4	5638022-02	5333025-02	3214010-355	3611005-180	5431115-02
C5	5638022-03	5333025-03	3214010-355	3611005-180	5431115-03
Size	11 Screw	12 Torque wrench	12a Adapter	20 Compression spring	
C3	3212010-362	BT-TK-02	5680035-05	5561001-71	
C4	3212010-364	C-TK-01	5680035-06	5561001-41	
C5	3212010-416	C-TK-01	5680035-07	5561001-41	

Draw bar set		Parts included in draw bar set					
Size	13 Draw bar set	14 Spiral retaining ring	15 Holder ring (set of 2)	16 Segment (set of 6)	17 O-ring	18 Flat wire spring	19 O-ring
C3	5461100-101	5545039-01	5546001-16	5549120-08	5641005-01	5561015-02	5641005-15
C4	5461100-111	5545039-03	5546001-20	5549120-06	5641005-05	5561015-03	5641005-19
C5	5461100-121	5545039-02	5546001-17	5549120-07	5641005-06	5561015-04	5641005-16

General ISO Turning

Steadyline®

MDT

Mini-Shaft™

Grooving

Parting-off

X4

Adapters
Clamping units

Accessories and
Spare parts

Workpiece
materials

Type 2000

General ISO Turning

Steadyline®

MDT

Mini-Shaft™

Grooving

Parting-off

X4

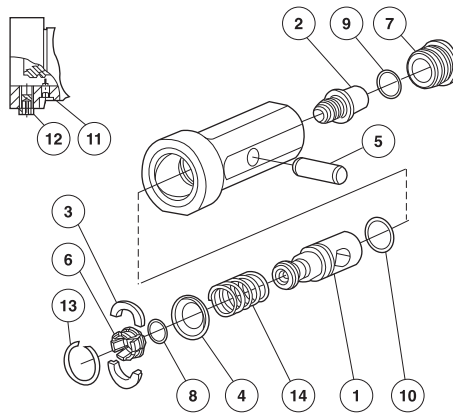

Size	1 Drawbar	2 Clamping screw	3 Holder ring (set of 2)	4 Ring	5 Support pin
C3	5461105-01	5519105-01	5546002-01	5541028-01	5552032-01
C4	5461105-02	5519105-02	5546002-02	5541028-02	5552032-02
C5	5461105-03	5519105-03	5546002-03	5541028-03	5552032-03
Size	6 Segment (set of 6)	7 Thread ring	8 O-ring	9 O-ring	10 O-ring
C3	5549120-08	5512091-03	5641005-01	3671010-118	3671010-124
C4	5549120-06	5512091-01	5641005-05	3671010-120	3671010-126
C5	5549120-07	5512091-02	5641005-06	3671010-124	3671010-128
Size	11 Holder ring (set of 2)	12 Ring	13 Support pin	14 Segment (set of 6)	Key (size, mm)
C3	3214020-204	3611005-180	5545042-01	5561001-52	3021013-080 (8,0)
C4	3214020-255	3611005-180	3421105-026	5561001-53	5680010-03 (10,0)
C5	3214020-255	3611005-180	3421105-032	5561001-54	12SMS795 (12,0)

Type 3000

Adapters
Clamping units

Accessories and
Spare parts

Workpiece
materials

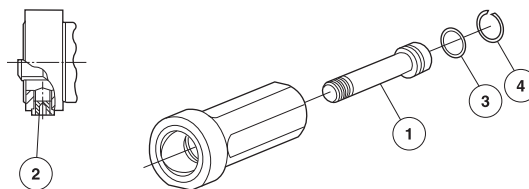

Size	1 Clamping screw	2 Blind plug	3 O-ring	4 Retaining ring	Key (size, mm)
C3	5512096-01	3611005-180	3671010-020	5545040-03	3021013-080 (8,0)
C4	5512096-02	3611005-180	3671010-022	5545040-05	5680010-03 (10,0)
C5	5512096-03	3611005-180	3671010-024	5545040-06	12SMS795 (12,0)

VDI angled design, DIN 69880

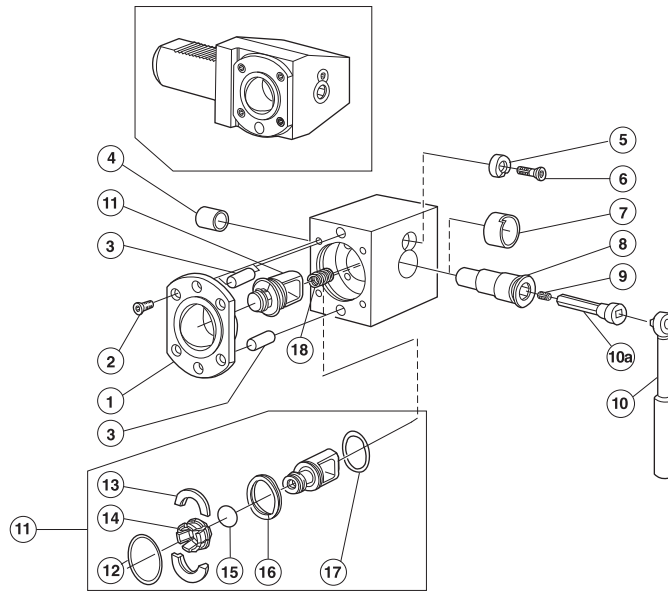

Size	1 Sleeve	2 Screw (4x)	3 Pin	4 Bushing	5 Locking washer
C3	5252010-01	416.1-834	3111050-558	3823010-101	5541030-01
C4	5252010-02	5513020-26	3111050-610	3823010-122	5541030-02
C5	5252010-03	5513020-14	3111050-661	3823010-162	5541030-03
C6	5252010-04	3213010-410	3111050-715	3823010-183	5541030-04

Size	6 Screw	7 Bushing	8 Cam shaft	9 Screw	10 Torque wrench
C3	416.1-834	5638022-01	5333025-01	3214010-355	BT-TK-02
C4	416.1-834	5638022-02	5333025-02	3214010-355	C-TK-01
C5	5513020-14	5638022-03	5333025-03	3214010-355	C-TK-01
C6	5513020-14	5638022-04	5333025-04	3214010-355	C-TK-01

Size	10a Adapter	18 Compression spring			
C3	5680035-05	5561001-71			
C4	5680035-06	5561001-41			
C5	5680035-07	5561001-41			
C6	5680035-07	5561001-41			

Draw bar set		Parts included in draw bar set					
Size	11 Draw bar set	12 Spiral retaining ring	13 Holder ring (set of 2)	14 Segment (set of 6)	15 O-ring	16 Flat wire spring	17 O-ring
C3	5461100-101	5545039-01	5546001-16	5549120-08	5641005-01	5561015-02	5641005-15
C4	5461100-111	5545039-03	5546001-20	5549120-06	5641005-05	5561015-03	5641005-19
C5	5461100-121	5545039-02	5546001-17	5549120-07	5641005-06	5561015-04	5641005-16
C6	5461100-131	5545039-04	5546001-18	5549120-04	5641005-04	5561015-05	5641005-17

General ISO Turning
Steadyline®
MDT
Mini-Shaft™
Grooving
Parting-off
X4
Adapters Clamping units
Accessories and Spare parts
Workpiece materials

VDI straight design, DIN 69880

General ISO Turning

Steadyline®

MDT

Mini-Shaft™

Grooving

Parting-off

X4

Adapters
Clamping units

Accessories and
Spare parts

Workpiece
materials

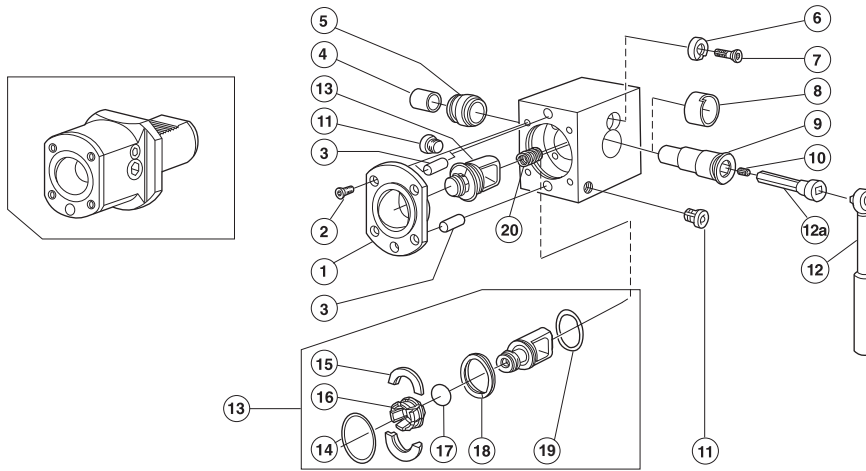

Size	1 Sleeve	2 Screw (4x)	3 Pin	4 Bushing	5 Sleeve
C3	5252010-01	416.1-834	3111050-558	3823010-101	5638024-01
C4	5252010-02	5513020-26	3111050-610	3823010-122	5638024-02
C5	5252010-03	5513020-14	3111050-661	3823010-162	5638024-03
C6	5252010-04	3213010-410	3111050-715	3823010-183	5638024-04

Size	6 Locking washer	7 Screw	8 Bushing	9 Cam shaft	10 Screw
C3	5541030-01	416.1-834	5638022-01	5333025-01	3214010-355
C4	5541030-02	416.1-834	5638022-02	5333025-02	3214010-355
C5	5541030-03	5513020-14	5638022-03	5333025-03	3214010-355
C6	5541030-04	5513020-14	5638022-04	5333025-04	3214010-355

Size	11 Plug	12 Torque wrench	12a Adapter	20 Compression spring
C3	3611005-180	BT-TK-02	5680035-05	5561001-71
C4	3611005-180	C-TK-01	5680035-06	5561001-41
C5	3611005-180	C-TK-01	5680035-07	5561001-41
C6	3611005-140	C-TK-01	5680035-07	5561001-41

Draw bar set		Parts included in draw bar set					
Size	13 Draw bar set	14 Spiral retaining ring	15 Holder ring (set of 2)	16 Segment (set of 6)	17 O-ring	18 Flat wire spring	19 O-ring
C3	5461100-101	5545039-01	5546001-16	5549120-08	5641005-01	5561015-02	5641005-15
C4	5461100-111	5545039-03	5546001-20	5549120-06	5641005-05	5561015-03	5641005-19
C5	5461100-121	5545039-02	5546001-17	5549120-07	5641005-06	5561015-04	5641005-16
C6	5461100-131	5545039-04	5546001-18	5549120-04	5641005-04	5561015-05	5641005-17

Type 2090

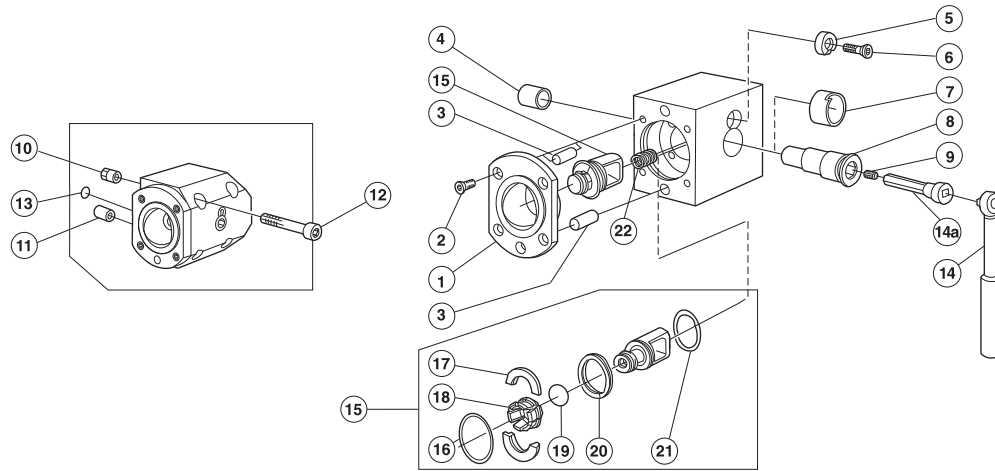

Size	1 Sleeve	2 Screw (4x)	3 Pin	4 Bushing	5 Locking washer	6 Screw
C3	5252010-01	416.1-834	3111050-558	3823010-101	5541030-01	416.1-834
C4	5252010-02	5513020-26	3111050-610	3823010-122	5541030-02	416.1-834
C5	5252010-03	5513020-14	3111050-661	3823010-162	5541030-03	5513020-14
C6	5252010-04	3213010-410	3111050-715	3823010-183	5541030-04	5513020-14
C8	5252010-05	3213010-462	3111050-769	3823010-225	5541030-05	5513020-14



Size	7 Bushing	8 Cam shaft	9 Screw	10 Locating pin	11 Dowel pin	12 Screw
C3	5638022-01	5333025-01	3214010-355	5552063-05	5552061-07	3212010-363
C4	5638022-02	5333025-02	3214010-355	5552063-07	5552061-09	3212010-414
C5	5638022-03	5333025-03	3214010-355	5552063-06	5552061-08	3212010-466
C6	5638022-04	5333025-04	3214010-355	5552063-03	5552061-05	3212010-469
C8	5638022-05	5333025-05	3214010-355	5552063-04	5552061-06	3212010-521

Size	13 O-ring	14 Torque wrench	14a Adapter	22 Compression spring
C3	5641001-22	BT-TK-02	5680035-05	5561001-71
C4	3671010-114	C-TK-01	5680035-06	5561001-41
C5	3671010-114	C-TK-01	5680035-07	5561001-41
C6	3671010-119	C-TK-01	5680035-07	5561001-41
C8	3671010-119	C-TK-02	5680035-07	5561001-41

Draw bar set		Parts included in draw bar set					
Size	15 Draw bar set	16 Spiral retaining ring	17 Holder ring (set of 2)	18 Segment (set of 6)	19 O-ring	20 Flat wire spring	21 O-ring
C3	5461100-101	5545039-01	5546001-16	5549120-08	5641005-01	5561015-02	5641005-15
C4	5461100-111	5545039-03	5546001-20	5549120-06	5641005-05	5561015-03	5641005-19
C5	5461100-121	5545039-02	5546001-17	5549120-07	5641005-06	5561015-04	5641005-16
C6	5461100-131	5545039-04	5546001-18	5549120-04	5641005-04	5561015-05	5641005-17
C8	5461100-141	5545039-05	5546001-19	5549120-05	5641005-07	5561015-06	5641005-18











General ISO Turning
Steadyline®
MDT
Mini-Shaft™
Grooving
Parting-off
X4
Adapters
Clamping units
Accessories and Spare parts
Workpiece materials



Hoses, Designation ordering code includes spare parts

Connection type	Designation	Length mm / inch
Straight fitting 	JET-HOSE150SS	150 / 5.906
	JET-HOSE200SS	200 / 7.874
	JET-HOSE250SS	250 / 9.843
	JET-HOSE300SS	300 / 11.811
Banjo fitting 	JET-HOSE150BS	150 / 5.906
	JET-HOSE200BS	200 / 7.874
	JET-HOSE250BS	250 / 9.843
	JET-HOSE300BS	300 / 11.811
Banjo-to-Banjo fitting 	JET-HOSE150BB	150 / 5.906
	JET-HOSE200BB	200 / 7.874
	JET-HOSE250BB	250 / 9.843
	JET-HOSE300BB	300 / 11.811

All hoses are pressure rated to a maximum of 275 bar / 3990 psi

Spare Parts, included in delivery

DesignationSS	...BS	...BB
JET-CFP1/8BSP		■	■	■
JET-CBP15		■	■	■
JET-AD1/8BSP		■	■	
JET-ADM10		■		
JET-BBM10			■	■
JET-BB1/8BSP			■	■
JET-C1/4-1/8BSP			■	■
JET-P1/8-5mm		■	■	■
JET-WM10*		■	■	■
JET-ORING10X1**		■	■	■

Designation	
JET-CFP0611	
JET-CFP0613	
JET-CFP0614	
JET-CFP0615	
JET-CLS0608	
JET-CS1115	
JET-CFP1/8BSP14	
JET-CFP1/8BSP12.7	
JET-CFP1/8BSP12	
JET-CFP1/8BSP10	

Pack of 2, except *Pack of 20
 ** Not suitable for use in inducer
 For assembly instructions, see page(s) 89

General ISO Turning
 Steadyline®
 MDT
 Mini-Shaft™
 Grooving
 Parting-off
 X4
 Adapters
 Clamping units
 Accessories and Spare parts
 Workpiece materials

Torque wrench

Size	Nm / In/Lbs.	Designation	Spare Parts		
			Adapter*	d	d ₁
C3	35 / 309.8	BT-TK-02	5680035-05	3/8"	8
C4	50 / 442.5	C-TK-01	5680035-06	1/2"	10
C5	70 / 619.6	C-TK-01	5680035-07	1/2"	12
C6	90 / 796.6	C-TK-01	5680035-07	1/2"	12
C8	130 / 1150.6	C-TK-02	5680035-07	1/2"	12

Sliding hammer for dismantling the polygon socket

Size	Designation
C3	CC-ET-01
C4	CC-ET-01
C5	CC-ET-02
C6	CC-ET-02
C8	CC-ET-02

* To be ordered separately

Tool for dismantling the polygon socket on manual clamping unit

Size	Designation	Spare Parts	
		Centre	Peripheral insert
C3	C3-WDT-01M	3214030-463	5512040-03
C4	C4-WDT-02	3214030-464	5512040-04
C5	C5-WDT-02	3214030-516	5512040-05
C6	C6-WDT-02	3214030-516	5512040-06
C8	C-TK-02	3214030-516	5512072-01

Grease nipple

Size	Designation
C3	5692012-01
C4	5692012-01
C5	5692012-01
C6	5692012-01
C8	5692012-01

Cover plug

Size	Designation	
	Type 3000	Other types
C3	C3-CP-11	C3-CP-01
C4	C4-CP-11	C4-CP-01
C5	C5-CP-11	C5-CP-01
C6	-	C6-CP-01
C8	-	C8-CP-01

Key's for changing nozzle

Nozzle key set	Parts included in set			Not included
	Key (T-handle)	Blade	Socket	Use for nozzle
NK-CN6	DOUBLE-T	H4B-H5.0	NK07.25-H5.0	CN6
NK-CN7	DOUBLE-T	H4B-H5.0	NK09.25-H5.0	CN7
NK-CN8	DOUBLE-T	H4B-H5.0	NK11.25-H5.0	CN8

General ISO Turning
Steadyline®
MDT
Mini-Shaft™
Grooving
Parting-off
X4
Adapters Clamping units
Accessories and Spare parts
Workpiece materials

Maximum Torque value for clamping screws

Screw designation	Torque Nm / In/Lbs.	Torque key
110.26-655	10,0 / 88.5	H00T-60100
117.26-655	5,0 / 44.3	H00T-3050
117.26-657	3,0 / 26.6	H00-2530
170.26-655	6,0 / 53.1	H00T-4060
C02205-T07P	0,9 / 8.0	T00-07P09
C02505-T07P	0,9 / 8.0	T00-07P09
C02506-T07P	0,9 / 8.0	T00-07P09
C03007-T09P	2,0 / 17.7	T00-09P20
C03508-T15P	3,0 / 26.6	T00-15P30
C03509-T15P	3,0 / 26.6	T00-15P30
C03510-T15P	3,0 / 26.6	T00-15P30
C03511-T09P	2,0 / 17.7	T00-09P20
C03512-T15P	3,0 / 26.6	T00-15P30
C04008-T15P	3,5 / 31.0	T00-15P35
C04010-T15P	3,5 / 31.0	T00-15P35
C04011-T15P	3,5 / 31.0	T00-15P35
C04014-T15P	3,5 / 31.0	T00-15P35
C04512-T15P	5,0 / 44.3	T00-15P50
C04518-T15P	5,0 / 44.3	T00-15P50
C05010-T20P	5,0 / 44.3	T00-20P50
C05012-T15P	5,0 / 44.3	T00-15P50
C05013-T20P	5,0 / 44.3	T00-20P50
C05018-T20P	5,0 / 44.3	T00-20P50
C11804-T06P	0,5 / 4.4	T00-06P05
C46017-T20P	6,0 / 53.1	T00T-20P60
C82204-T06P	0,5 / 4.4	T00-06P05
CC05	0,9 / 8.0	H00-1509
CC08P-V13	2,0 / 17.7	T00-09P20
CC09P-D11	2,0 / 17.7	T00-09P20
CC12P-S12	3,5 / 31.0	T00-15P35
CC14	6,0 / 53.1	H00T-4060
CC16	10,0 / 88.5	-
CC17P	10,0 / 88.5	-
CC17P-06	10,0 / 88.5	-
CC17P-09	10,0 / 88.5	-
CC20P	10,0 / 88.5	-
CC20P-V13	10,0 / 88.5	-
CD09-S09	2,0 / 17.7	T00-09P20
CD12-S12	3,5 / 31.0	T00-15P35
CD16-S16	5,0 / 44.3	T00-20P50
CD19-S19	5,0 / 44.3	T00-20P50
CD19-V16	5,0 / 44.3	T00-20P50
CSC8015-T20P	5,0 / 44.3	T00-20P50
CSC1015-T20P	5,0 / 44.3	T00-20P50
CSP16-T15P	2,0 / 17.7	T00-15P20
CSP22-T15P	3,0 / 26.6	T00-15P30
CSP27-T25P	6,0 / 53.1	T00T-25P60

Screw designation	Torque Nm / In/Lbs.	Torque key
L84017-T09P	2,0 / 17.7	T00-09P20
L85011-T15P	5,0 / 44.3	T00-15P50
L85012-T15P	5,0 / 44.3	T00-15P50
L85017-T09P	2,0 / 17.7	T00-09P20
L85020-T15P	3,5 / 31.0	T00-15P35
L85021-T15P	3,5 / 31.0	T00-15P35
L86015-T20P	6,0 / 53.1	T00T-20P60
L86025-T20P	6,0 / 53.1	T00T-20P60
LD1035-T25P	6,0 / 53.1	T00T-25P60
LD5020-T09P	2,0 / 17.7	T00-09P20
LD6020-T15P	3,0 / 26.6	T00-15P30
LD6021-T09P	2,0 / 17.7	T00-09P20
LD6024-T20P	3,0 / 26.6	T00-15P30
LD6025-T15P	3,0 / 26.6	T00-15P30
LD6026-T09P	2,0 / 17.7	T00-09P20
LD8025-T25P	6,0 / 53.1	T00T-25P60
LD8030-T25P	6,0 / 53.1	T00T-25P60
LS0512	2,5 / 22.1	-
LS0613	3,0 / 26.6	H00-2530
LS0616	3,0 / 26.6	H00-2530
LS0818	4,0 / 35.4	-
LS0822	4,0 / 35.4	-
MC6S4X14	3,5 / 31.0	-
MC6S4X18	3,5 / 31.0	-
MC6S5X14	5,0 / 44.3	H00T-4050
MC6S5X18	5,0 / 44.3	H00T-4050
MN0909L-T09P	2,0 / 17.7	T00-09P20
MN1215L-T15P	3,0 / 26.6	T00-15P30
MN1215R-T15P	3,0 / 26.6	T00-15P30
MN1215S-T15P	3,0 / 26.6	T00-15P30
MN1215T-T15P	3,0 / 26.6	T00-15P30
MN1515-T15P	3,0 / 26.6	T00-15P30
MN1515SL-T15P	3,0 / 26.6	T00-15P30
MN1520-T20P	6,0 / 53.1	T00T-20P60
MN1920-T20P	6,0 / 53.1	T00T-20P60
MN1925-T25P	5,0 / 44.3	T00T-25P50
MN2525-T25P	6,0 / 53.1	T00T-25P60
PL1403-T09P	2,5 / 22.1	T00-09P20
TCEI0409	3,5 / 31.0	-
TCEI0509	6,0 / 53.1	H00T-4060
TCEI0513	6,0 / 53.1	H00T-4060
TCEI0609	8,0 / 70.8	H00T-5080
TCEI0613	8,0 / 70.8	H00T-5080
TCEI0614	8,0 / 70.8	H00T-5080
TCEI0620	8,0 / 70.8	H00T-5080
TCEI0815	10,0 / 88.5	H00T-60100
TCEI0825	10,0 / 88.5	H00T-60100
TCEI1020	15,0 / 132.8	-
WS1620-T20P	3,5 / 31.0	T00-20P35
WS1920-T20P	3,5 / 31.0	T00-20P35
WS2325-T25P	5,0 / 44.3	T00T-25P50

For the Seco range of torque keys, please see next page

Workpiece materials



Torque key range

The range of torque keys with fixed torque values are available, in combinations key grip/torque value for insert locking, for most of the Seco turning products. By using a torque key you always ensure the correct tightening force when mounting the insert. The torque value is given on page(s) 1004 for each screw. Torque keys are calibrated according to ISO 6789.



Code key: T00-15P35

- T00 = Torque screwdriver type for Torx Plus blade
- T00T = Torque T-handle type for Torx Plus blade
- H00 = Torque screwdriver for hexagonal blade
- H00T = Torque T-handle type for hexagonal blade



- 15P = Torx Plus size
- 35 = Torque value 3,5 Nm

Torque key*	Replaceable blade	Torx Plus size	Torque value Nm / In/Lbs.
			
T00-06P05	T00-06P	T06P	0,5 / 4,4
T00-07P05	T00-07P	T07P	0,5 / 4,4
T00-07P09	T00-07P	T07P	0,9 / 8,0
T00-08P12	T00-08P	T08P	1,2 / 10,6
T00-08P20	T00-08P	T08P	2,0 / 17,7
T00-09P09	T00-09P	T09P	0,9 / 8,0
T00-09P12	T00-09P	T09P	1,2 / 10,6
T00-09P20	T00-09P	T09P	2,0 / 17,7
T00-10P20	T00-10P	T10P	2,0 / 17,7
T00-10P30	T00-10P	T10P	3,0 / 26,6
T00-10P35	T00-10P	T10P	3,5 / 31,0
T00-15P20	T00-15P	T15P	2,0 / 17,7
T00-15P30	T00-15P	T15P	3,0 / 26,6
T00-15P35	T00-15P	T15P	3,5 / 31,0
T00-15P40	T00-15P	T15P	4,0 / 35,4
T00-15P50	T00-15P	T15P	5,0 / 44,3
T00-20P35	T00-20P	T20P	3,5 / 31,0
T00-20P50	T00-20P	T20P	5,0 / 44,3



*Including blade

Torque key*	Replaceable blade	Torx Plus size	Torque value Nm / In/Lbs.
			
T00T-15P50	T00T-15P	T15P	5,0 / 44,3
T00T-20P50	T00T-20P	T20P	5,0 / 44,3
T00T-20P60	T00T-20P	T20P	6,0 / 53,1
T00T-20P80	T00T-20P	T20P	8,0 / 70,8
T00T-25P50	T00T-25P	T25P	5,0 / 44,3
T00T-25P60	T00T-25P	T25P	6,0 / 53,1
T00T-25P80	T00T-25P	T25P	8,0 / 70,8
T00T-30P80	T00T-30P	T30P	8,0 / 70,8

*Including blade

Torque key*	Replaceable blade	Hexagonal size mm / inch	Torque value Nm / In/Lbs.
			
H00-1305	H00-1.3	1,3 / 0.050	0,5 / 4,4
H00-1505	H00-1.5	1,5 / 0.060	0,5 / 4,4
H00-1509	H00-1.5	1,5 / 0.060	0,9 / 8,0
H00-2009	H00-2.0	2,0 / 0.080	0,9 / 8,0
H00-2016	H00-2.0	2,0 / 0.080	1,6 / 14,2
H00-2020	H00-2.0	2,0 / 0.080	2,0 / 17,7
H00-2512	H00-2.5	2,5 / 0.098	1,2 / 10,6
H00-2530	H00-2.5	2,5 / 0.098	3,0 / 26,6
H00-2535	H00-2.5	2,5 / 0.098	3,5 / 31,0
H00-3020	H00-3.0	3,0 / 0.120	2,0 / 17,7
H00-3030	H00-3.0	3,0 / 0.120	3,0 / 26,6
H00-4030	H00-4.0	4,0 / 0.160	3,0 / 26,6

*Including blade

Torque key*	Replaceable blade	Hexagonal size mm / inch	Torque value Nm / In/Lbs.
			
H00T-3050	H00T-3.0	3,0 / 0.120	5,0 / 44,3
H00T-4050	H00T-4.0	4,0 / 0.160	5,0 / 44,3
H00T-4060	H00T-4.0	4,0 / 0.160	5,0 / 44,3
H00T-5050	H00T-5.0	5,0 / 0.200	5,0 / 44,3
H00T-5080	H00T-5.0	5,0 / 0.200	8,0 / 70,8
H00T-50100	H00T-5.0	5,0 / 0.200	10,0 / 88,5
H00T-60100	H00T-6.0	6,0 / 0.240	10,0 / 88,5

*Including blade

Please observe that the blades are not interchangeable between screwdriver type and T-handle type.

Torx Plus® is a registered trade mark belonging to Camcar-TeXtron (USA)

SMG – Introduction

Cutting speed v_c (m/min)

The foundation for SMG is a classification of workpiece materials based on their type rather than their relative machinability and consequently it contains workpiece materials like composites. It is comprehensive enough, but still easy to identify which SMG a particular material belongs.

Each SMG has a specific material standard in a specific condition assigned as reference to allow easy adjustment of cutting data for any actual material compared to any Seco reference material see page(s) 103.

As example the reference materials EN C45E for SMG P4 and EN 42 CrMo 4 for both SMG P5 and SMG H5 see further details in the following tables.

Steels, ferritic and martensitic stainless steels

SMG	Description	Properties	Reference	$k_{c1.1}$	m_c
P1	Free-cutting steels	$360 < R_m < 880$	11 SMn30 $R_m = 385 \text{ N/mm}^2$	1500	0,14
P2	Low-alloy ferritic steels, C < 0.25%wt Low-alloy weldable general structural steels	$320 < R_m < 600$	S235JRG2 $R_m = 420 \text{ N/mm}^2$	1600	0,23
P3	Ferritic & ferritic/pearlitic steels, C < 0.25%wt Weldable general structural steels Case-hardening steels	$430 < R_m < 610$	16 MnCr 5 $R_m = 550 \text{ N/mm}^2$	1800	0,14
P4	Low-alloy general structural steels, $0.25\% < C < 0.67\%$ wt Low-alloy Quench & Temper steels	$520 < R_m < 1200$	C 45E $R_m = 660 \text{ N/mm}^2$	2000	0,15
P5	Structural steels, $0.25\% < C < 0.67\%$ wt Quench & Temper steels	$550 < R_m < 1200$	42 CrMo 4 $R_m = 700 \text{ N/mm}^2$	2020	0,18
P6	Low-alloy through-hardening steels, C > 0.67%wt Low-alloy spring and bearing steels	$520 < R_m < 1200$	C 100S $R_m = 600 \text{ N/mm}^2$	2100	0,17
P7	Through-hardening steels, C > 0.67%wt Spring and bearing steels	$600 < R_m < 1200$	100 Cr 6 $R_m = 650 \text{ N/mm}^2$	2160	0,17
P8	Tool steels High Speed Steels (HSS)	$600 < R_m < 1200$	X 40 CrMoV 5 1 $R_m = 700 \text{ N/mm}^2$	2400	0,20
P11	Ferritic & martensitic stainless steels	$415 < R_m < 1200$	X 20 Cr 13 $R_m = 675 \text{ N/mm}^2$	2000	0,15
P12	Maraging and precipitation-hardening stainless steels	$500 < R_m < 1200$	X 5 CrNiCuNb 16 4 $R_m = 1100 \text{ N/mm}^2$	2100	0,17

Free-cutting, austenitic and duplex stainless steels

SMG	Description	Properties	Reference	$k_{c1.1}$	m_c
M1	Free-cutting austenitic stainless steels		X 10 CrNiS 18 9	1700	0,14
M2	Low-alloy austenitic stainless steels		X 5 CrNi 18 10	1920	0,18
M3	Medium-alloy austenitic stainless steels		X 2 CrNiMo 18 14 3	2070	0,17
M4	High-alloy austenitic and duplex stainless steels		X 2 CrNiMoN 22 5 3	2230	0,16
M5	Difficult high-alloy austenitic and duplex stainless steels		X 2 CrNiMoN 25 7 4	2510	0,13

Cast irons

SMG	Description	Properties	Reference	$k_{c1.1}$	m_c
K1	Grey cast irons (GCI)		EN-GJL-250	930	0,32
K2	Compacted graphite irons (CGI)		EN-GJV-400	1000	0,35
K3	Malleable cast irons (MCI)		EN-GJMB-550-4	1050	0,37
K4	Nodular cast irons (SGI)		EN-GJS-500-7	1160	0,37
K5	Austempered ductile irons (ADI)		EN-GJS-1000-5		
K6	Austenitic lamellar cast irons		EN-GJLA-XNiCuCr15-6-2		
K7	Austenitic nodular cast irons		EN-GJSA-XNiMn23-4		

Non-ferrous metals

SMG	Description	Properties	Reference	$k_{c1.1}$	m_c
N1	Aluminium alloys, Si < 9%		AW-7075		
N2	Aluminium alloys, 9% < Si < 16%		AC-44200 Si = 12%		
N3	Aluminium alloys, Si > 16%		AISI17Cu5		
N11	Copper alloys		CW614N	740	0,26

Superalloys and titanium

SMG	Description	Properties	Reference	$k_{c1.1}$	m_c
S1	Iron-based superalloys		Disalloy		
S2	Cobalt-based superalloys		Stellite 21		
S3	Nickel-based superalloys		Inconel 718	2530	0,21
S11	Titanium, low alloyed, (α)		Ti		
S12	Titanium, medium alloyed, (α + β)		TiAl6V4	1500	0,24
S13	Titanium, high alloyed, (near β and β)		Ti10V2Fe3Al		

General ISO Turning

Steadyline®

MDT

Mini-Shaft™

Grooving

Parting-off

X4

 Adapters
Clamping units

 Accessories and
Spare parts

 Workpiece
materials

Hard materials

SMG	Description	Properties	Reference	$k_{c1.1}$	m_c
H3	Case-hardened steels	58 < HRC < 62	16 MnCr 5 60 HRC	2070	0,14
H5	Quenched & Tempered steels	38 < HRC < 56	42 CrMo 4 50 HRC	2320	0,18
H7	Quenched & Tempered steels Bearing steels	56 < HRC < 64	100 Cr 6 60 HRC	2480	0,17
H8	Tool steels High Speed Steels (HSS)	38 < HRC < 64	X 40 CrMoV 5 1 50 HRC	2750	0,20
H11	Martensitic stainless steels	38 < HRC < 50	X 20 Cr 13 45 HRC	2300	0,15
H12	Maraged and precipitation-hardened stainless steels	1200 < R_m < 1650	X 5 CrNiCuNb 16 4 $R_m = 1450 \text{ N/mm}^2$	2410	0,17
H21	Manganese steels	23 < HRC < 64	X 120 Mn 12 50 HRC		
H31	White cast irons	50 < HRC < 64	EN-GJN-HV600(XCr11) 55 HRC		

Other difficult materials

SMG	Description	Properties	Reference	$k_{c1.1}$	m_c
PM1	Low-alloy PM-materials		F-0008 Fe-0.7C		
PM2	Medium-alloy PM-materials		FLC-4608 Fe2Cu1.8Ni 0.5Mo0.2Mn0.8C		
PM3	High-alloy PM-materials Exhaust valve seat materials, etc.				
HF1	Hardfacing alloys Welded or plasma-deposited iron-based alloys				
HF2	Hardfacing alloys Welded or plasma-deposited cobalt- and nickel-based alloys				
CC1	Sintered tungsten carbide		G50		

General ISO Turning
Steadyline®
MDT
Mini-Shaft™
Grooving
Parting-off
X4
Adapters
Clamping units
Accessories and
Spare parts
Workpiece
materials

Plastics and Composites

SMG	Description	Properties	Reference	$k_{c1.1}$	m_c
TS1	Thermosetting polymers		Urea formaldehyde (UF)		
TS2	Thermosetting carbon-fibre composites		T300 T700 T800 HTA-S IMA - Epoxy (M21)...		
TS3	Thermosetting glass-fibre composites		Epoxy - HX..(42..)E glass (7781...)...		
TS4	Thermosetting aramide-fibre composites		Kevlar 49		
TP1	Thermoplastic polymers		Polycarbonate (PC)		
TP2	Thermoplastic carbon-fibre composites		PPS/PEEK - T300..		
TP3	Thermoplastic glass-fibre composites		PPS/PEEK - E glass or A glass...		
TP4	Thermoplastic aramide-fibre composites				

Graphite

SMG	Description	Properties	Reference	$k_{c1.1}$	m_c
GR1	Graphite		R 8500		

General ISO Turning

Steadyline®

MDT

Mini-Shaft™

Grooving

Parting-off

X4

 Adapters
Clamping units

 Accessories and
Spare parts

 Workpiece
materials

SMG

SMG	EN	EN-Nr	W.-Nr	DIN	AFNOR	BS	UNI	JIS	SS	UNS
P1	11 SMn 30	1.0715	1.0715	9 SMn 28	S 250	230 M 07	CF 9 SMn 28	SUM 22	1912	G12130
	11 SMnPb 30	1.0718	1.0718	9 SMnPb 28	S 250 Pb		CF 9 SMnPb 28	SUM 22 L	1914	G12134
	10 S 20	1.0721	1.0721	10 S 20	10 F 1	210 M 15	CF 10 S 20			
			1.0722	10 SPb 20	10 PbF 2		CF 10 SPb 20			
	15 SMn 13	1.0725	1.0723	15 S 20		210 A 15		SUM 32	1922	
	35 S20	1.0726	1.0726	35 S 20	35 MF 4	212 M 36			1957	G11400
	46 S20	1.0727	1.0727	46 S 20	45 MF 4	212 M 44			1973	G11460
	11 SMn 37	1.0736	1.0736	9 SMn 36	S 300	240 M 07	CF 9 SMn 36			G12150
11 SMn 37	1.0736	1.0736	9 SMn 36	S 300	240 M 07	CF 9 SMn 36			G12150	
S235JR	1.0037	1.0037	St 37-2	E 24-2		Fe 360 B	STKM 12 C		1311	
S235JRG2	1.0038	1.0116	St 37-3	E 24-3, E 24-4	4360-40 C	Fe 360 D FF			1312, 1313	
S275J2G3	1.0144	1.0144	St 44-3 N	E 28-3, E 28-4	4360-43 C	Fe 430 D FF	SM 41 C		1412, 1414	
C 10	1.0301	1.0301	C 10	34 C 10, XC 10	045 M 10	C 10	S 10 C			G10100
		1.0401	C 15	37 C 12, XC 18	080 M 15	C 15, C 16			1350	G10170
C22	1.0402	1.0402	C 22	C 20	050 A 20	C 20, C 21			1450	G10200
S355JR	1.0570	1.0570	St 52-3	E 36-3, E 36-4	4360-50 C	Fe 510 B	SM 50 YA		2172, 2132	
C 15R	1.1141	1.1141	Ck 15	XC 15, XC 18	080 M 15	C 15, C 16			1370	G10170
		1.1158	Ck 25	XC 25	060 A 25	C 25	S 25 C			G10250
		1.2162	21 MnCr 5	20 NC 5			SCR 420 H			
P3	16 Mo 3	1.5415	1.5415	15 Mo 3	15 D 3	1501-240	16 Mo 3		2912	
			1.5423	16 Mo 5		1503-245-420	16 Mo 5	SB 450 M		G45200
	14 NiCr 14	1.5752	1.5752	14 NiCr 14	12 NC 15	655 M 13		SNC 815 (H)		G33106
			1.5919	15 CrNi 6	16 NC 6	S 107	16 CrNi 4			
	18 NiCrMo 7 6	1.6587	1.6587	18 CrNiMo 7 6	18 NCD 6	820 A 16	18 NiCrMo 7			
	16 MnCr 5	1.7131	1.7131	16 MnCr 5	16 MC 5	527 M 17	16 MnCr 5	SCR 415	2511	G51170
	16 MnCrS 5	1.7139	1.7139	16 MnCrS 5						
	20 MnCr 5	1.7147	1.7147	20 MnCr 5	20 MC 5		20 MnCr 5	SMnC 420 (H)		G51200
	20 MnCrS 5	1.7149	1.7149	20 MnCrS 5	20 MnCrS 5			SMnC 21 H		
	13 CrMo 4 5	1.7335	1.7335	13 CrMo 4 4	15 CD 3.5	1501-620 Gr. 27	14 CrMo 4 5		2216	
		1.7337	16 CrMo 4 4	15 CD 4.5	1501-620 Gr. 27	14 CrMo 4 5		2216		
10 CrMo 9 10	1.7380	1.7380	10 CrMo 9 10	10 CD 9.10	1501-622 Gr. 31	12 CrMo 9 10		2218	J21890	
P4	C35		1.0501	C 35	55 C 35	060 A 35	C 35		1550	G10350
	E 335	1.0503	1.0503	C 45	65 C 45	80 M 46	C 45	S 45 C	1650	G10430
	C40		1.0511	C 40	60 C 40	080 M 40		S 40 C		
	E 360	1.0070	1.0535	St 70-2	A 70-2		Fe 690		1655	
	C60	1.0601	1.0601	C 60	CC 55	080 A 62	C 60			G10600
			1.1157	40 Mn 4	35 M 5	150 M 36				G10390
	G 28 Mn6	1.1165	1.1165	30 Mn 5		120 M 36		SMn 1 H, SCMn 2		G13300
	C 35E	1.1181	1.1181	Ck 35	XC 38 H1	080 M 36	C 35	S 35 C	1572	G10340
	C 45E	1.1191	1.1191	Ck 45	XC 42	080 M 46	C 45	S 45 C	1672	G10420
	C 60E	1.1221	1.1221	Ck 60	XC 60	080 A 62	C 60	S 58 C	1665, 1678	G10640
			1.1740	C 60 W	Y3 55			SK 7		
	P5	55 SiCr7	1.7100	1.0904	55 Si 7	55 S 7	250 A 53	55 Si 8		2085, 2090
			1.2330	35 CrMo 4	34 CD 4	708 A 37	35 CrMo 4			T51620
			1.2542	45 WCrV 7		BS 1	45 WCrV 8 KU		2710	T41901
			1.2714	56 NiCrMoV 7		BH 224-5	56 NiCrMoV7-KU	SKT 4		T61206
			1.5121	46 MnSi 4						
			1.5710	36 NiCr 6	35 NC 6	640 A 35			SNC 236	
			1.5736	36 NiCr 10	35 NC 11		35 NiCr 9	SNC 631 (H)		
36 CrNiMo 4			1.6511	36 CrNiMo 4	40 NCD 3	816 M 40	38 NiCrMo 4 (KB)			G98400
34 CrNiMo 6		1.6582	1.6582	34 CrNiMo 6	35 NCD 6	817 M 40	35 NiCrMo 6 (KW)	SNCM 447	2541	G43400
34 Cr 4		1.7033	1.7033	34 Cr 4	32 C 4	530 A 32	34 Cr 4 (KB)	SCR 430 (H)		G51320
41 Cr 4		1.7035	1.7035	41 Cr 4	42 C 4	530 M 40	41 Cr 4	SCR 440 (H)		G51400
25 CrMo 4		1.7218	1.7218	25 CrMo 4	25 CD 4 S	708 M 25	25 CrMo 4 (KB)	SCM 425	2225	G41300
42 CrMo 4		1.7225	1.7225	42 CrMo 4	42 CD 4	708 M 40	42 CrMo 4	SCM 440 (H)	2244	G41400
42 CrMo 4		1.7225	1.7225	42 CrMo 4	42 CD 4	708 M 40	42 CrMo 4	SCM 440 (H)	2244	G41400
			1.7361	32 CrMo 12	30 CD 12	722 M 24	32 CrMo 12		2240	
50 CrV 4	1.8159	1.8159	50 CrV 4	50 CV 4	735 A 50	51 CrV 4	SUP 10	2230	H61500	
41 CrAlMo 7 10	1.8509	1.8509	41 CrAlMo 7	40 CAD 6.12	905 M 39	41 CrAlMo 7	SACM 645	2940	K24065	
C 67S	1.1231	1.1231	Ck 67	XC 68	060 A 67	C 70		1770	G10700	
C 100S	1.1274	1.1274	Ck 101		060 A 96		SUP 4	1870	G10950	
C 105U	1.1545	1.1545	C 105 W1	Y1 105		C 100 KU		1880		
		1.1645	C 105 W2	Y1 105		C 100 KU	SK 3			
		1.1663	C 125 W	Y2 120		C 120 KU	SK 2			

General ISO Turning
Steadyline®
MDT
Mini-Shaft™
Grooving
Parting-off
X4
Adapters
Clamping units
Accessories and Spare parts
Workpiece materials

SMG

U.N.E./ I.H.A.	AISI / ASTM	GOST	ČSN	Misc. Brands	Condition	Structure
	1213				Annealed	
	12 L 13				Annealed	
	1108				Annealed	
	11 L 08				Annealed	
					Annealed	
	1140	40			Annealed	
	1146				Annealed	
	1215				Annealed	
	12 L 14				Annealed	
		16D			Annealed	
	A573 Grade 58	18kp	11 378		Annealed	
	A573 Grade 70	St14kP	11 448		Annealed	
	1010	10			Annealed	
F.1110	1015	15			Annealed	
	1020, 1023	20	12 024		Annealed	
		17G1S	11 523		Annealed	
F.1511	1015	15			Annealed	
F.1120	1025	25			Annealed	
					Annealed	
	A204 Grade A		15 020		Annealed	
	4520				Annealed	
	3310, 9314	20X2H4A	16 420		Annealed	
	4320		16 220		Annealed	
					Annealed	
F.1516	5115	12KHN2	14 220		Annealed	
		18HG			Annealed	
	5120	20KH	14 221		Annealed	
	5120 H	20KH			Annealed	
	A182-F11, A182-F12	12KHM	15 121		Annealed	
	A387 Grade 12 Cl. 2				Annealed	
F.155	A182-F22	12KH8	15 313		Annealed	
F.1130	1035	35	12 040		Annealed	
F.5110	1045	45	12 050		Annealed	
	1040	40	12 041		Annealed	
F.1150	1055	55			Annealed	
	1060	60	12 061		Annealed	
	1039	40G			Annealed	
	1330	30G2			Annealed	
F.1135	1035	35			Annealed	
F.1140	1045	45	12 050		Annealed	
F.1150	1064	60			Annealed	
	1060	60			Annealed	
F.144	9255	55S2			Annealed	
F.1250	4135	35KHM			Annealed	
F.5241	S1	5KHV2S			Annealed	
	L6	5KHNV			Annealed	
	5045				Annealed	
	3135				Quenched & Tempered	
	3435				Annealed	
	9840				Quenched & Tempered	
F.1280	4340	38H2N2MA	16 343		Annealed	
	5132	35KH			Quenched & Tempered	
	5140	40H	14 140		Quenched & Tempered	
F.1251	4130	20KHM	15 130		Quenched & Tempered	
F.1252	4142, 4140	38HM	15 142		Annealed	
F.1252	4142, 4140	38HM	15 142		Quenched & Tempered	
					Quenched & Tempered	
F.143	6150	50KHFA	15 260		Quenched & Tempered	
F.1740	A355 Cl. A				Annealed	
F.5103	1070	70			Annealed	
F.5117	1095				Annealed	
F.5118	W1	U10A			Annealed	
		U10			Annealed	
	W1	U13			Annealed	

General ISO Turning

Steadyline®

MDT

Mini-Shaft™

Grooving

Parting-off

X4

 Adapters
Clamping units

 Accessories and
Spare parts

 Workpiece
materials

SMG

SMG	EN	EN-Nr	W.-Nr	DIN	AFNOR	BS	UNI	JIS	SS	UNS	
P7	107 CrV 3	1.2210	1.2210	115 CrV 3	100 C 3		107 CrV 3 KU			T61202	
			1.2510	100 MnCrW 4	90 MWCV 5	BO 1	95 MnWCr 5 KU	SKS 3	2140	T31501	
	90 MnCrV 8	1.2842	1.2842	90 MnCrV 8	90 MV 8		90 MnVCr 8 KU			T31502	
	100 Cr 6	1.3505	1.3505	100 Cr 6	100 C 6	534 A 99	100 Cr 6	SUJ 2	2258	G51986	
P8	X 210 Cr 12	1.2080	1.2080	X 210 Cr 12	Z 200 C 12	BD 3	X 210 Cr 13 KU	SKD 1		T30403	
			1.2343	X 38 CrMoV 5 1	Z 38 CDV 5	BH 11	X 37 CrMoV 5 1 KU	SKD 6		T20811	
	X 40 CrMoV 5 1	1.2344	1.2344	X 40 CrMoV 5 1	Z 40 CDV 5	BH 13	X 40 CrMo 5 1 1 KU	SKD 61	2242	T20813	
	X 100 CrMoV 5	1.2363	1.2363	X 100 CrMoV 5 1	Z 100 CDV 5	BA 2	X 100 CrMoV 5 1 KU	SKD 12	2260	T30102	
			1.2365	X 32 CrMoV 3 3	32 DCV 28	BH 10	30 CrMoV 12 27 KU	SKD 7		T20810	
			1.2436	X 210 CrW 12			X 215 CrW 12 1 KU	SKD 2		2312	
			1.2601	X 165 CrMoV 12			X 165 CrMoV 12 KU			2310	
			1.2713	55 NiCrMoV 6	55 NCDV 7			SKT 4			T61206
	HS 6-5-2-5	1.3243	1.3243	S 6-5-2-5	Z 85 WDKCV 06-05-05-04-02		HS 6-5-2-5	SKH 55		2723	
	HS 2-10-1-8	1.3247	1.3247	S 2-10-1-8	Z 110 DKCWW 09-08-04	BM 42	HS 2-9-1-8	SKH 51			T11342
	HS 18-1-2-5	1.3255	1.3255	S 18-1-2-5	Z 80 WKCW 18-05-04-01	BT 4	HS 18-1-1-5	SKH 3			T12004
HS 6-5-2	1.3343	1.3343	S 6-5-2	Z 85 WDCV 06-05-04-02	BM 2	HS 6-5-2	SKH 9, SKH 51		2722	T11302	
HS 2-9-2	1.3348	1.3348	S 2-9-2	Z 100 DCWW 09-04-02-02		HS 2-9-2	SKH 58		2782	T11307	
HS 18-0-1	1.3355	1.3355	S 18-0-1	Z 80 WCV 18-04-01	BT 1	HS 18-0-1	SKH 2			T12001	
P11	X 6 Cr 13	1.4000	1.4000	X 6 Cr 13	Z 6 C 12	403 S 17	X 6 Cr 13	SUS 403	2301	S41008	
	X 12 Cr 13	1.4006	1.4006	X 10 Cr 13	Z 10 C 13	410 S 21	X 12 Cr 13	SUS 410	2302	S41000	
	X 6 Cr 17	1.4016	1.4016	X 6 Cr 17	Z 8 C 17	430 S 15	X 8 Cr 17	SUS 430	2320	S43000	
	X 20 Cr 13	1.4021	1.4021	X 20 Cr 13	Z 20 C 13	420 S 37	X 20 Cr 13	SUS 420 J 1	2303	S42000	
	X 39 Cr 13	1.4031	1.4031	X 40 Cr 13	Z 40 C 14	420 S 45	X 40 Cr 14	SUS 420	2304	S40280	
	X 70 CrMo 15	1.4109	1.4109	X 65 CrMo 14	Z 70 D 14			SUS 440 A		S44002	
	X 90 CrMoV 18	1.4112	1.4112	X 90 CrMoV 18	Z 2 CND 18 05	409 S 19	X CrTi 12	SUS 440 B	2327	S44003	
	X 105 CrMo 17	1.4125	1.4125	X 105 CrMo 17	Z 100 CD 17		X 105 CrMo 17	SUS 440 C		S44004	
	X 3 CrNiMo 13 3	1.4313	1.4313	X 5 CrNi 13 4	Z 5 CN 13 4	425 C 11	X 6 CrNi 13 04	SCS 5		2385	S41500
	X 18 CrNi 28	1.4749	1.4749	X 18 CrNi 28	Z 18 C 25					2322	S44600
P12	X 6 NiCrTiMoV 25 15	1.4534	1.4534	X 3 CrNiMoAl 13 8 2						S13800	
	X 4 CrNiCuNb 16 4	1.4540	1.4540	X 4 CrNiCuNb 16 4						S15500	
		1.4540	1.4540	X 4 CrNiCuNb 16 4	Z 4 CNUNb 16.4 M					S15500	
	X 4 CrNiCuNb 16 4	1.4540	1.4540	X 4 CrNiCuNb 16 4						S15500	
	X 5 CrNiCuNb 16 4	1.4542	1.4542	X 5 CrNiCuNb 16 4				SUS 630		S17400	
	X 5 CrNiCuNb 17 4	1.4548	1.4548	X 5 CrNiCuNb 17 4	Z 6 CNU 17.4			SCS 24, SUS 630		S17400	
	X 7 CrNiAl 17 7	1.4564	1.4564	X 7 CrNiAl 17 7	Z 9 CAN 17.7	301 S 81	X 7 CrNiAl 17 7	SUS 631	2388	S17700	
	X 2 NiCoMoTi 18 12 4	1.6356	1.6356	X 2 NiCoMoTi 18 12 4						K93160	
	X 2 NiCoMoTi 18 9 5	1.6358	1.6358	X 2 NiCoMoTi 18 9 5	Z 2 NKD 19-09					K93120	
	X 2 NiCoMo 18 9 5	1.6358	1.6358	X 2 NiCoMoTi 18 9 5	Z 2 NKD 19-09					K93120	
	X 2 NiCoMo 18 8 5	1.6359	1.6359	X 2 NiCoMo 18 8 5		S 162				K92890	
	X 2 NiCoMo 18 8 5	1.6359	1.6359	X 2 NiCoMo 18 8 5		S 162				K92890	
	M1	X 10 CrNiS 18 9	1.4305	1.4305	X 10 CrNiS 18 9	Z 10 CNF 18.09	303 S 31	X 10 CrNi 18 09	SUS 303	2346	S30300
X 2 CrNi 19 11		1.4306	1.4306	X 2 CrNi 19 11	Z 2 CN 18.10	304 S 12	X 3 Cr Ni 18 11	SUS 304 L	2352	S30403	
X 5 CrNi 18 10		1.4301	1.4301	X 5 CrNi 18 10	Z 6 CN 18.09	304 S 31	X 5 CrNi 18 11	SUS 304	2333	S30400	
X 5 CrNiMo 17 12 2		1.4401	1.4401	X 5 CrNiMo 17 12 2	Z 3 CND 17.11.1	316 S 31	X 5 CrNiMo 17 12	SUS 316	2347	S31600	
M2	X 6 CrNiNb 18 10	1.4550	1.4550	X 6 CrNiNb 18 10	Z 6 CNNb 18.10	347 S 31	X 6 CrNiNb 18 11	SUS 347		S34700	
	X 9 CrNi 18 8	1.4310	1.4310	X 12 CrNi 17 7	Z 12 CN 17.07	301 S 21	X 12 CrNi 17 07	SUS 301	(2331)	S30100	
	X 12 CrNi 18 8	1.4300	1.4300	X 12 CrNi 18 8	Z 12 CN 18	302 S 25		SUS 302		S30200	
	X 2 CrNiMo 18 14 3	1.4435	1.4435	X 2 CrNiMo 18 14 3	Z 2 CND 17.13	316 S 12	X 2 CrNiMo 17 13 2	SCS 16, SUS 316 L	2353	S31603	
M3	X 2 CrNiMoN 17 13 3	1.4429	1.4429	X 2 CrNiMoN 17 13 3	Z 2 CND 17.13 Az	316 S 62	X 2 CrNiMoN 17 13 3	SUS 316 LN	2375	S31653	
	X 2 CrNiN 18 10	1.4311	1.4311	X 2 CrNiN 19 11	Z 2 CN 18 .10 Az	304 S 62	X 2 CrNiN 18 11	SUS 304 LN	2371	S30453	
	X 3 CrNiMo 18 12 3	1.4466	1.4466	X 5 CrNi 18 15		317 S 16	X 5 CrNi 18 15	SUS 317		S31700	
	X 9 CrNiSiN 21 11 2	1.4835	1.4893	X 9 CrNiSiN 21 11 2		310 S 31				2368	S30815
M4	X 12 CrNi 25 21	1.4335	1.4335	X 12 CrNi 25 21	Z 12 CN 25.20	310 S 24	X 6 CrNi 26 20	SUH 310, SUS 310 S	2361	S31008	
	X 2 CrNiMoN 22 5 3	1.4462	1.4462	X 2 CrNiMoN 22 5	Z 2 CND 22.05 Az	332 S 15	X 2 CrNiMoN 22 5			2377	S31803
	X 2 CrNiMoSi 19 5	1.4424	1.4417	X 2 CrNiMoSi 19 5	Z 2 CND 18.05.03					2376	S31500
	X 2 NiCrMoCu 25 20 5	1.4539	1.4539	X 2 NiCrMoCu 25 20 5	Z 2 NCDU 25 20	904 S 13				2562	N08904
M5	X 3 CrNiMo 27 5 2	1.4460	1.4460	X 4 CrNiMo 27 5 2	Z 3 CND 25.7 Az		X 3 CrNiMo 27 5 2	SUS 329 J 1	2324	S32900	
	X 5 CrNiCuNb 16 4	1.4980	1.4943	X 4 NiCrTi 25 15	Z 6 NCTDV 25.15	HR 51		SUH 660	2570	S66286	
	X 1 CrNiMoN 20 18 7	1.4547	1.4529	X 1 CrNiMoN 20 18 7	Z 1 CNDU 20.18.05 Az		X 1 CrNiMoN 20 18 7			2778	S31254
	X 1 CrNiMoN 25 22 8	1.4652	1.4652	X 2 CrNiMoN 25 22 7							S32654
M5	X 10 NiCrAlTi 32 20	1.4876	1.4876	X 10 NiCrAlTi 32 20	Z 10 NC 32.21			NCF 800		N08800	
	X 2 CrNiMoN 25 7 4	1.4410	1.4410	X 2 CrNiMoN 25 7 4	Z 3 CND 25.07 Az		X 2 CrNiMoN 25 7 4		2328	S32750	

General ISO Turning
Steadyline®
MDT
Mini-Shaft™
Grooving
Parting-off
X4
Adapters Clamping units
Accessories and Spare parts
Workpiece materials

SMG

U.N.E./ I.H.A.	AISI / ASTM	GOST	ČSN	Misc. Brands	Condition	Structure
F.520L	L2	11KHF			Annealed	
F.5220	O1	9KHVG			Annealed	
	O2	9G2F			Annealed	
F.5230	52100	SHKH15	14 109		Annealed	
F.5212	D3	KH12			Annealed	
	H11	4KH5MFS			Annealed	
F.5318	H13	4KH5MF1S			Annealed	
F.5227	A2	9KH5VF			Annealed	
	H10	3KH3M3F			Annealed	
F.5213		KH12			Annealed	
		KH12MF			Annealed	
F.520.S	L6	5KHNM			Annealed	
F.5613	M35	R6M5K5			Annealed	
	M42	R2AM9K5			Annealed	
	T4	R18K5F2			Annealed	
F.5603	M2	R6M5			Annealed	
	M7				Annealed	
	T1	R18			Annealed	
	403	08KH13			Annealed	Ferritic
F.3401	410, CA-15	12KH13, 08KH13			Annealed	Martensitic
F.3113	430	12KH17			Annealed	Ferritic
F.5261	420	20KH13	17 022		Annealed	Martensitic
F.3404	420	40KH13			Annealed	Martensitic
	440 A				Annealed	Martensitic
	440 B	95KH18			Annealed	Martensitic
	440 C	95KH18			Annealed	Martensitic
	A182 F6NM			F6NM	Annealed	Martensitic
	446	15KH28			Annealed	Ferritic
	XM-13			PH 13-8 Mo	Solution annealed	Austenitic
	XM-12			15-5 PH	H1150	Martensitic
	XM-12			15-5 PH	Solution annealed	Martensitic
	XM-12			15-5 PH	H1025	Martensitic
	SAE 630			17-4 PH	H1150	Martensitic
	630			17-4 PH	Solution annealed	Martensitic
	631	09KH17N7YU1		17-7 PH	Solution annealed	Austenitic/Ferritic
	AMS 6515			Marage 350	Solution annealed	Martensitic
	AMS 6521			Marage 300	Solution annealed	Martensitic
	AMS 6514			Marage 300, Vascomax C300	Solution annealed	Martensitic
	AMS 6512			Marage 250	Solution annealed	Martensitic
	AMS 6512			Marage 250, Vascomax C250	Solution annealed	Martensitic
F.3508	303	12KH19N9			Annealed	Austenitic
F.3504	304 L	03KH18N11			Annealed	Austenitic
F.3504	304	08KH18N10	17 240		Annealed	Austenitic
F.3534	316	08KH17H13M2T	17 346		Annealed	Austenitic
F.3524	347	08KH18N12B			Annealed	Austenitic
F.3517	301	07KH16N6			Annealed	Austenitic
	302	12KH18N9			Annealed	Austenitic
F.3533	(316 L)	03KH17N14M3	17 349		Annealed	Austenitic
	316 LN	03KH16N15M3			Annealed	Austenitic
F.3541	304 LN	03KH18N11			Annealed	Austenitic
	317	08KH17H15M3T			Annealed	Austenitic
				253 MA	Annealed	Austenitic
	310 S	12KH25N20			Annealed	Austenitic
	329 LN			SAF 2205	Annealed	Duplex
				3RE60	Annealed	Duplex
	904L				Annealed	Super austenitic
	329				Annealed	Duplex
	660			A286	Solution annealed	Austenitic
				254 SMO	Annealed	Super austenitic
				654 SMO	Annealed	Super austenitic
				Alloy 800	Annealed	Austenitic
	F 53			SAF 2507	Annealed	Super duplex

General ISO Turning

Steadyline®

MDT

Mini-Shaft™

Grooving

Parting-off

X4

 Adapters
Clamping units

 Accessories and
Spare parts

 Workpiece
materials

SMG

SMG	EN	EN-Nr	W.-Nr	DIN	AFNOR	BS	UNI	JIS	SS	UNS	
K1	EN-GJL-150	0.6150	0.6150	GG-15	Fl 15 D	Grade 150	G15	FC 150	01 15-00	F11601	
	EN-GJL-200	0.6200	0.6200	GG-20	Fl 20 D	Grade 220	G20	FC 200	01 20-00	F12101	
	EN-GJL-250	0.6250	0.6250	GG-25	Fl 25 D	Grade 260	G25	FC 250	01 25-00	F12401	
	EN-GJL-350	0.6350	0.6350	GG-35	Fl 35 D	Grade 350	G35	FC 350	01 35-00	F13502	
	EN-GJL-215			GG-220 HB					02 19		
K2	EN-GJV-300			GJV-300							
	EN-GJV-350			GJV-350							
	EN-GJV-400			GJV-400							
	EN-GJV-450			GJV-450							
K3	EN-GJMB-550-4	0.8155		GTS-55-04	P 540/5	P 540/5	P 55-04	PCMP55-04	08 54-00	F24130	
	EN-GJS-350-22	0.7033	0.7033	GGG-35.3	FGS 370-17	Grade 350/22		FCD 350-22L	07 17-15		
K4	EN-GJS-400-15	0.7040	0.7040	GGG-40	FGS 400-12	Grade 420/12	GS 400-12	FCD 400-18L	07 17-02	F32800	
	EN-GJS-400-18	0.7043	0.7043	GGG-40.3	FGS 370-17	Grade 370/17	GSO 42/17		07 17-12	F32800	
	EN-GJS-500-7	0.7050	0.7050	GGG-50	FGS 500-7	Grade 500/7	GS 500-7	FCD 500-7	07 27-02	F33800	
	EN-GJS-600-3	0.7060	0.7060	GGG-60	FGS 600-3	Grade 600/3	GS 600-3	FCD 600-3	07 32-03	F34100	
	EN-GJS-700-2	0.7070	0.7070	GGG-70	FGS 700-2	Grade 700/2	GS 700-2	FCD 700-2	07 37-01	F34800	
K5	EN-GJS-1000-5			GJS-1000-5						ADI grade 5	
	EN-GJS-1200-2			GJS-1200-2						ADI grade 2	
	EN-GJS-1400-1			GJS-1400-1						ADI grade 3	
	EN-GJS-800-8			GJS-800-8						ADI grade 4	
K6	EN-GJLA-XNiCr 20-2	0.6660	0.6660	GGL-NiCr 20 2	FGL Ni20 Cr2	Grade F2			05 23-00	F41002	
	EN-GJLA-XNiCr 30-3	0.6676	0.6676	GGL-NiCr 30 3	FGL Ni30 Cr3	Grade F3				F41004	
K7	EN-GJLA-XNiCuCr 15-6-2	0.6655	0.6655	GGL-NiCuCr 15 6 2	FGL Ni15 Cu6 Cr2	Grade F1				F41000	
	EN-GJSA-XNiMn 13-7	0.7652	0.7652	GGG-NiMn 13 7	FGS Ni13 Mn7	Grade S6			07 72-00		
	EN-GJSA-XNiCr 20-2	0.7660	0.7660	GGG-NiCr 20 2	FGS Ni20 Cr2	Grade S2				F43000	
	EN-GJSA-XNiMn 23-4	0.7673	0.7673	GGG-NiMn 23 4	FGS Ni23 Mn4	Grade S2M				F43010	
	EN-GJSA-XNiCr 30-3	0.7676	0.7676	GGG-NiCr 30 3	FGS Ni30 Cr3	Grade S3				F43003	
N1	EN-GJSA-XNi 35	0.7683	0.7683	GGG-Ni 35	FGS Ni35					F43006	
	AW-1050A	Al99.5	3.0255	Al99.5	A-5/1050A	1B	(A1050)		4007	AA1050A	
	AW-2011	AlCuBiPb	3.1655	AlCuBiPb	A-U5PbBi/2011	FC1		A2011	4355	AA2011	
	AW-2014	AlCuSiMn	3.1255	AlCuSiMn	A-U4SG/2014	H15			4338	AA2014	
	AW-5005	AlMg1	3.3315	AlMg1	A-G0.6	N41			4106	AA5005	
	AW-6060	AlMgSi0.5	3.3206	AlMgSi0.5	A-GS/6060	(H9)			4103	AA6060	
	AW-6063	AlMgSi0.7	3.3210	AlMgSi0.7	A-GSUC/6061	(H10)		(A6063)	4104, 4107	AA6005	
	AW-3103	AlMn1	3.0515	AlMn1		N3			4054	AA3103	
	AW-3003	AlMn1Cu	3.0517	AlMn1Cu	A-M1/3003			A3003		AA3003	
	AW-7020	AlZn4.5Mg1	3.4335	AlZn4.5Mg1	A-Z5G/7020	H17			4425	AA7020	
	AW-7075		3.4365	AlZnMgCu1.5	A-Z5GU/7075	2L95/2L96			A7075	AA7075	
	AC-42000		3.2341	G-AlSi5Mg	A-S7G	LM25	3599		AC 4C	4244	
	AC-46200	AlSi8Cu3(Si)	3.2161	G-AlSi8Cu3						4251	A13800
	MG-P-63	MgAl6Zn	3.5612	G-MgAl6Zn	G-A6-Z1	MAG-E-121					M11600
	MG-P-61	MgAl8Zn	3.5812	G-MgAl8Zn	(G-A7-Z1)						
	MN65120	MgSe3Zn2Zr1	3.5103	G-MgSe3Zn2Zr1	ZRE1	MAG6-TE					M12330
	AC-43400	AlSi10Mg(Fe)	3.2381	G-AlSi10Mg	A-S10G	LM9				4253	A13600
	AC-44200	AlSi12	3.2382	GD-AlSi12							
	AW-6082	AlMgSi1	3.2315	AlMgSi1	A-SGM0.7/6082	H30				4212	AA6082
	N3	CC331G		2.0940.01	CuAl10Fe	CuAl10Fe	AB1			5710	C95200
CC333G			2.0975.01	CuAl10Ni	CuAl10Ni5Fe5	AB2			5716	C95500	
N11			2.0872	CuNi10Fe1Mn	CuNi10Fe1Mn	CN102			5667	C70600	
				CuNi10Zn45							
			2.0790	CuNi18Zn19Pb	CuNi18Zn19Pb1						C76300
	CW352H		2.1176	CuSn10Pb10	CuSn10Pb10	LB2			5640	C93700	
	CC480K		2.1050.01	CuSn10	CuSn10	CT1			5443	C90700	
			2.1087	CuSn10Zn					5458	C90500	
	CW452K	CuSn6	2.1020	CuSn6	CuSn6	PB103	C5191		5428	C51900	
	CW502L	CuZn15	2.0240	CuZn15	CuZn15	CZ102	C2300		5112	C23000	
	CW706R	CuZn28Sn1	2.0470	CuZn28Sn1	CuZn29Sn1				5220	C44300	
	CW508L	CuZn37	2.0321	CuZn37	CuZn37	CZ108			5150	C27200	
	CW717R	CuZn38Sn1	2.0530	CuZn38Sn1						C46400	
	CW614N	CuZn39Pb3	2.0401	CuZn39Pb3	CuZn39Pb3	CZ121			5170	C38500	
CW612N	CuZn40Pb2	2.0402	CuZn40Pb2	CuZn39Pb2	CZ120			5168	C37800		
CW622N	CuZn44Pb2	2.0410	CuZn44Pb2		CZ104			5272	C68700		

General ISO Turning
Steadyline®
MDT
Mini-Shaft™
Grooving
Parting-off
X4
Adapters Clamping units
Accessories and Spare parts
Workpiece materials

SMG

SMG	EN	EN-Nr	W.-Nr	DIN	AFNOR	BS	UNI	JIS	SS	UNS	
S1											
S2											
S3	NiMo30		2.4810							N10002	
	NiMo16Cr15W		2.4819							N10276	
	NiCr19Fe19Nb5Mo3		2.4668							N07718	
			2.4669							N07750	
	NiCr20TiAl		2.4631							N07080	
S3	NiCr19Co18Mo4Ti3Al3									N07500	
	NiCr20Co13Mo4Ti3Al		2.4654							N07001	
S11			3.7024							R54620	
S12										R56320	
S12	TiAl6V4		3.7164							R56400	
S13				TiV10Fe2Al3							
H3	16 MnCr 5	1.7131	1.7131	16 MnCr 5	16 MC 5	527 M 17	16 MnCr 5	SCR 415	2511	G51170	
H5	C 67S	1.1231	1.1231	Ck 67	XC 68	060 A 67	C 70		1770	G10700	
	C 75S	1.1248	1.1248	Ck 75	XC 75	060 A 78	C 75		1774, 1778	G10780	
	C 100S	1.1274	1.1274	Ck 101		060 A 96		SUP 4	1870	G10950	
	C 105U	1.1545	1.1545	C 105 W1	Y1 105		C 100 KU		1880		
			1.2550		60 WCrV 7	55 WC 20		55 WCrV 8 KU			
H5	55 Cr 3	1.7176	1.7176	55 Cr 3	55 C 3	527 A 60	55 Cr 3	SUP 9 (A)	2253	G51550	
	42 CrMo 4	1.7225	1.7225	42 CrMo 4	42 CD 4	708 M 40	42 CrMo 4	SCM 440 (H)	2244	G41400	
	107 CrV 3	1.2210	1.2210	115 CrV 3	100 C 3		107 CrV 3 KU			T61202	
			1.2510		100 MnCrW 4	90 MWCV 5	BO 1	95 MnWCr 5 KU	SKS 3	2140	T31501
H7	90 MnCrV 8	1.2842	1.2842	90 MnCrV 8	90 MV 8	BO 2	90 MnVCr 8 KU			T31502	
	100 Cr 6	1.3505	1.3505	100 Cr 6	100 C 6	534 A 99	100 Cr 6	SUJ 2	2258	G51986	
	X 40 CrMoV 5 1	1.2344	1.2344	X 40 CrMoV 5 1	Z 40 CDV 5	BH 13	X 40 CrMo 5 1 1 KU	SKD 61	2242	T20813	
H8	X 100 CrMoV 5	1.2363	1.2363	X 100 CrMoV 5 1	Z 100 CDV 5	BA 2	X 100 CrMoV 5 1 KU	SKD 12	2260	T30102	
	X 155 CrVMo 12 1		1.2379	X 155 CrVMo 12 1	Z 160 CDV 12	BD 2	X 155 CrVMo 12 1 KU	SKD 11		T30402	
			1.2436	X 210 CrW 12			X 215 CrW 12 1 KU	SKD 2	2312		
			1.2601	X 165 CrMoV 12			X 165 CrMoV 12 KU		2310		
			1.2713	55 NiCrMoV 6	55 NCDV 7			SKT 4			T61206
	HS 6-5-2-5	1.3243	1.3243	S 6-5-2-5	Z 85 WDKCV 06-05-05-04-02		HS 6-5-2-5	SKH 55	2723		
	HS 2-10-1-8	1.3247	1.3247	S 2-10-1-8	Z 110 DKCWV 09-08-	BM 42	HS 2-9-1-8	SKH 51			T11342
HS 18-0-1	1.3355	1.3355	S 18-0-1	Z 80 WCV 18-04-01	BT 1	HS 18-0-1	SKH 2			T12001	
H11	X 20 Cr 13	1.4021	1.4021	X 20 Cr 13	Z 20 C 13	420 S 37	X 20 Cr 13	SUS 420 J 1	2303	S42000	
	X 70 CrMo 15	1.4109	1.4109	X 65 CrMo 14	Z 70 D 14			SUS 440 A		S44002	
	X 90 CrMoV 18	1.4112	1.4112	X 90 CrMoV 18	Z 2 CND 18 05	409 S 19	X CrTi 12	SUS 440 B	2327	S44003	
	X 105 CrMo 17	1.4125	1.4125	X 105 CrMo 17	Z 100 CD 17		X 105 CrMo 17	SUS 440 C		S44004	
H12	X 4 CrNiCuNb 16 4	1.4540	1.4540	X 4 CrNiCuNb 16 4						S15500	
	X 5 CrNiCuNb 16 4	1.4542	1.4542	X 5 CrNiCuNb 16 4				SUS 630		S17400	
	X 5 CrNiCuNb 16 4	1.4542	1.4542	X 5 CrNiCuNb 16 4				SUS 630		S17400	
	X 7 CrNiAl 17 7	1.4568	1.4568	X 7 CrNiAl 17 7	Z 9 CAN 17.7	301 S 81	X 7 CrNiAl 17 7	SUS 631	2388	S17700	
	X 8 CrNiMoAl 15 7 5	1.4574	1.4574	X 8 CrNiMoAl 15 7 5						S15700	
	X 6 NiCrTiMoV 25 15	1.4980	1.4943	X 4 NiCrTi 25 15	Z 6 NCTDV 25.15	HR 51		SUH 660	2570	S66286	
	X 2 NiCoMo 18 8 5	1.6359	1.6359	X 2 NiCoMo 18 8 5		S 162				K92890	
	X 2 NiCoMoTi 18 9 5	1.6358	1.6358	X 2 NiCoMoTi 18 9 5	Z 2 NKD 19-09					K93120	
	X 2 NiCoMoTi 18 9 5	1.6358	1.6358	X 2 NiCoMoTi 18 9 5	Z 2 NKD 19-09					K93120	
	X 2 NiCoMoTi 18 12 4	1.6356	1.6356	X 2 NiCoMoTi 18 12 4						K93160	
H21	X 120 Mn 12	1.3401	1.3401	X 120 Mn 12	Z 120 M 12	BW 10		SC MnH 1	2183		
H31	EN-GJN-HV520	0.9620	0.9620	G-X330 NiCr 4 2	FB Ni4 Cr2 BC	Grade 2 A			05 12-00	F45001	
	EN-GJN-HV550	0.9625	0.9625	G-X260 NiCr 4 2	FB Ni4 Cr2 HC	Grade 2 B			05 13-00	F45000	
	EN-GJN-HV600(XCr11)	0.9630	0.9630	G-X300 CrNiSi 9 5 2	FB Cr9 Ni5	Grade 2 C, D, E			04 57-00	F45003	

General ISO Turning
Steadyline®
MDT
Mini-Shaft™
Grooving
Parting-off
X4
Adapters
Clamping units
Accessories and
Spare parts
Workpiece
materials

SMG

U.N.E./ I.H.A.	AISI / ASTM	GOST	ČSN	Misc. Brands	Condition	Structure
				Discalloy	Precipitation hardened	
				Haynes 25		
				Stellite 21		
				Hastelloy C		
		KHN65MV		Hastelloy C-276		
				IN 100		
				Inconel 718		
				Inconel X-750	Solution annealed	
				Nimonic 80A		
				René 41		
				Udimet 500		
				Waspalloy		
				Ti	Commercially pure	Ti (α)
	AMS 4919			Ti 6-2-4-2	Annealed	Ti (α)
	AMS 4943			Ti 3Al-2.5V (grd 9)	Annealed	Ti (α+β)
	AMS 4920, Grade 5	VT6		Ti 6Al-4V	Annealed	Ti (α+β)
	AMS 4986			Ti 10V-2Fe-3Al	Annealed	Ti (β)
F.1516	5115	12KHN2	14 220		Case hardened	
F.5103	1070	70			Quenched & Tempered	
F.5107	1078, 1080	75			Quenched & Tempered	
F.5117	1095				Quenched & Tempered	
F.5118	W1	U10A			Quenched & Tempered	
	S1	5KHV2SF			Quenched & Tempered	
	5155				Quenched & Tempered	
F.1252	4142, 4140	38HM	15 142		Quenched & Tempered	
F.520L	L2	11KHF			Quenched & Tempered	
F.5220	O1	9KHVG			Quenched & Tempered	
	O2	9G2F			Quenched & Tempered	
F.5230	52100	SHKH15	14 109		Quenched & Tempered	
F.5318	H13	4KH5MF1S			Quenched & Tempered	
F.5227	A2	9KH5VF			Quenched & Tempered	
F.5211	D2	KH12MF			Quenched & Tempered	
F.5213		KH12			Quenched & Tempered	
		KH12MF			Quenched & Tempered	
F.520.S	L6	5KHNM			Quenched & Tempered	
F.5613	M35	R6M5K5			Quenched & Tempered	
	M42	R2AM9K5			Quenched & Tempered	
	T1	R18			Quenched & Tempered	
F.5261	420	20KH13	17 022		Quenched & Tempered	Martensitic
	440 A				Quenched & Tempered	Martensitic
	440 B	95KH18			Quenched & Tempered	Martensitic
	440 C	95KH18			Quenched & Tempered	Martensitic
	XM-12			15-5 PH	H900	Martensitic
	SAE 630			17-4 PH	H1025	Martensitic
	SAE 630			17-4 PH	H900	Martensitic
	AMS 5528	09KH17N7YU1		17-7 PH	TH1050	Martensitic
	632			PH 15-7 Mo	TH1050	Martensitic
	660			A286	Precipitation hardened	Austenitic
	AMS 6512			Marage 250	Precipitation hardened	Martensitic
	AMS 6521			Marage 300	Precipitation hardened	Martensitic
	AMS 6521			Marage 300	Precipitation hardened	Martensitic
	AMS 6515			Marage 350	Precipitation hardened	Martensitic
	A128 Grade A			Hadfield		
	A532 IB (NiCr-LC)			Ni-Hard 2		White cast iron
	A532 IA (NiCr-HC)			Ni-Hard 1		White cast iron
	A532 ID (Ni-HiCr)			Ni-Hard 4		White cast iron

General ISO Turning

Steadyline®

MDT

Mini-Shaft™

Grooving

Parting-off

X4

 Adapters
Clamping units

 Accessories and
Spare parts

 Workpiece
materials

General ISO Turning

Cemented carbide inserts and insert carriers

Cemented carbide inserts and cemented carbide insert carriers from Seco Tools are not included in the product range intended for the following requirements. Nevertheless Seco Tools can make the following declaration. These products meet all requirements in RoHS (Restriction of the use of certain Hazardous Substances in electrical and electronic equipment), WEEE (Waste Electrical & Electronic Equipment) and ELV (End of Life Vehicles) requirements. Products do not contain mercury, lead, hexavalent chromium, cadmium, CFC, HCFC, flame retardants or solvents in concentrations that exceed specifications in the regulations.

Regrinding:

Wet or dry grinding can produce potentially hazardous dusts or mists that can irritate skin, eyes, nose, throat and result in lung damage or disease. To avoid injury use proper safety precautions and protective equipment.

Disposal:

Seco Tools will buy back used inserts and solid carbide tools for recycling. Inserts and solid carbide tools should be separated from other metal waste (steel, aluminium, copper etc). All packing material is fully recyclable.

Steadyline®

MDT

CBN and PCD inserts

Inserts from Seco Tools are not included in the product range intended for the following requirements. Nevertheless Seco Tools can make the following declaration. This product meets all requirements in RoHS (Restriction of the use of certain Hazardous Substances in electrical and electronic equipment), WEEE (Waste Electrical & Electronic Equipment) and ELV (End of Life Vehicles) requirements. Products do not contain mercury, lead, hexavalent chromium, cadmium, CFC, HCFC, flame retardants or solvents in concentrations that exceed specifications in the regulations.

Regrinding:

Wet or dry grinding can produce potentially hazardous dusts or mists that can irritate skin, eyes, nose, throat and result in lung damage or disease. To avoid injury use proper safety precautions and protective equipment.

Disposal:

Seco Tools will buy back used CBN- or PCD-tipped inserts for recycling. Inserts should be separated from other metal waste (steel, aluminium, copper etc). Solid CBN-inserts may be discarded as landfill waste. All packing material is fully recyclable.

Mini-Shaft™

Grooving

Parting-off

Black oxide insert carriers

Insert carriers from Seco Tools are not included in the product range intended for the following requirements. Nevertheless Seco Tools can make the following declaration. This product meets all requirements in RoHS (Restriction of the use of certain Hazardous Substances in electrical and electronic equipment), WEEE (Waste Electrical & Electronic Equipment) and ELV (End of Life Vehicles) requirements. Products do not contain mercury, lead, hexavalent chromium, cadmium, CFC, HCFC, flame retardants or solvents in concentrations that exceed specifications in the regulations.

Disposal:

Used insert carriers may be sent for recycling together with ordinary steel waste (swarf and discarded steel scrap) for recycling. All packing material is fully recyclable.

X4

Adapters
Clamping units

Accessories and
Spare parts

Workpiece
materials

Cermet inserts

Inserts from Seco Tools are not included in the product range intended for the following requirements. Nevertheless Seco Tools can make the following declaration.

This product meets all requirements in RoHS (Restriction of the use of certain Hazardous Substances in electrical and electronic equipment), WEEE (Waste Electrical & Electronic Equipment) and ELV (End of Life Vehicles) requirements.

Cermet grade C15M inserts do contain nickel and will leach nickel when in contact with the skin. Amount of leaching is higher than specified in norm SS-EN 1811 Reference test method for release of nickel from products intended to come into direct and prolonged contact with the skin. These norms are intended for products that are in direct and prolonged contact with the skin and are therefore not directly applicable for cermet inserts. Persons with known allergic reactions to nickel are advised to wear protective gloves when handling cermet inserts.

Regrinding:

Wet or dry grinding can produce potentially hazardous dusts or mists that can irritate skin, eyes, nose, throat and result in lung damage or disease. To avoid injury use proper safety precautions and protective equipment.

Disposal:

Used inserts may be recycled. Inserts should be separated from other metal waste (steel, aluminium, copper, etc) including cemented carbide inserts. All packing material is fully recyclable.

Nickel coated insert carriers

Insert carriers from Seco Tools are not included in the product range intended for the following requirements. Nevertheless Seco Tools can make the following declaration.

This product meets all requirements in RoHS (Restriction of the use of certain Hazardous Substances in electrical and electronic equipment), WEEE (Waste Electrical & Electronic Equipment) and ELV (End of Life Vehicles) requirements.

Products do not contain mercury, lead, hexavalent chromium, cadmium, CFC, HCFC, flame retardants or solvents in concentrations that exceed specifications in the regulations. Insert carriers do contain nickel and will leach nickel when in contact with the skin. Amount of leaching is not higher than norm SS-EN 1811 Reference test method for release of nickel from products intended to come into direct and prolonged contact with the skin.

These norms are intended for products that are in direct and prolonged contact with the skin and are therefore not directly applicable for insert carriers. Persons with known allergic reactions to nickel are advised to wear protective gloves when handling nickel coated insert carriers.

Disposal:

Used tools maybe sent for recycling together with ordinary steel waste (swarf and discarded steel scrap) for recycling. All packing material is fully recyclable.

Intentionally added alloying elements

Grade	Cemented carbide											Coating						
	W	Ti	Ta	Nb	Co	Cr	Ni	Mo	C	N	Ru	Ti	Al	C	N	O	Si	Nb
CP20	■				■				■			■			■			
CP200	■				■	■			■			■	■		■			
CP300	■	■	■	■	■				■			■	■		■			
CP500	■				■	■			■			■	■		■			
CP600	■				■	■			■			■	■		■			
C15M	■	■	■	■	■		■	■	■	■								
CF	■				■				■									
CM	■				■				■									
DP2000	■				■				■			■			■	■		
DP3000	■	■	■	■	■				■			■	■	■	■	■		
DS2050	■				■	■			■			■	■		■			■
DS4050	■				■				■			■	■		■			■
F15M	■				■				■			■	■		■			
F25M	■	■	■	■	■				■			■	■		■			
F30M	■				■				■			■	■		■			
F40M	■				■				■			■	■		■			
HX	■		■		■				■			■			■			
H02	■		■		■				■			■			■			
H15	■				■				■			■			■			
H25	■				■				■			■			■			
KX	■				■				■			■			■			
MH1000	■				■				■			■	■		■			
MK1500	■				■				■			■	■		■	■		
MK2050	■				■				■			■	■	■	■		■	
MM4500	■				■				■			■	■	■	■	■		
MP1501	■				■				■			■	■	■	■	■		
MP2050	■				■				■		■	■	■	■	■	■		
MP2501	■				■				■			■	■	■	■	■		
MP3000	■				■				■			■	■	■	■	■		
MS2500	■				■				■			■	■	■	■	■		
MS2050	■				■				■			■	■	■	■	■		
RX1500	■				■		■	■	■			■	■	■	■			■
RX2000	■				■				■			■	■	■	■			
RM2020	■				■				■			■	■	■	■			
RM2090	■				■				■			■	■	■	■			
RN2010	■				■				■			■	■	■	■			
RS2090	■				■				■			■	■	■	■			
T350M	■				■				■			■	■	■	■	■		
T25M	■				■				■			■	■	■	■	■		
TGH1050	■				■				■			■	■	■	■	■		
TGK1500	■				■				■			■	■	■	■	■		
TGP25	■	■	■	■	■				■			■	■	■	■	■		
TGP35	■				■				■			■	■	■	■	■		
TGP45	■				■				■			■	■	■	■	■		
TGS2050	■				■				■			■	■	■	■	■		
TH1000	■				■				■			■	■	■	■	■		
TH1500	■				■				■			■	■	■	■	■		
TK0501	■				■				■			■	■	■	■	■		
TK1501	■				■				■			■	■	■	■	■		
TM1501	■	■	■	■	■				■			■	■	■	■	■		
TM2000	■	■	■	■	■				■			■	■	■	■	■		
TM2501	■	■	■	■	■				■			■	■	■	■	■		
TM3501	■	■	■	■	■				■			■	■	■	■	■		
TM4000	■	■	■	■	■				■			■	■	■	■	■		
TP0501	■	■	■	■	■				■			■	■	■	■	■		
TP1020	■	■	■	■	■				■			■	■	■	■	■		
TP1030	■	■	■	■	■				■			■	■	■	■	■		
TP1501	■	■	■	■	■				■			■	■	■	■	■		
TP25	■	■	■	■	■				■			■	■	■	■	■		
TP200	■	■	■	■	■				■			■	■	■	■	■		
TP2501	■	■	■	■	■				■			■	■	■	■	■		
TP3501	■	■	■	■	■				■			■	■	■	■	■		
TP40	■				■				■			■	■	■	■	■		
TS2000	■				■				■			■	■	■	■	■		
TS2050	■				■				■			■	■	■	■	■		
TS2500	■				■				■			■	■	■	■	■		
TTP2050	■				■				■			■	■	■	■	■		
T250D	■				■				■			■	■	■	■	■		
T400D	■				■				■			■	■	■	■	■		
T100R	■				■				■			■	■	■	■	■		
T60M	■	■	■	■	■				■			■	■	■	■	■		
883	■				■				■			■	■	■	■	■		
890	■				■				■			■	■	■	■	■		

This work is published with the understanding that Seco Tools and its editors are supplying information aimed to present a general orientation and direction of metal cutting and related sciences. If professional services are required for specific applications, the assistance of an appropriate professional should be acquired.

The information is provided “as is”; Seco Tools and its editors disclaim all representations and warranties, express or implied, of any kind, including, without limitations, any warranties of merchantability, fitness for a particular purpose, title, or non-infringement. In no event will Seco Tools or its editors be liable to any party for any direct, indirect, special or other consequential damages for any use of the information, even if Seco Tools or its editors are advised of the possibility of such damage.

The information provided herein is for reference purposes only. Actual prices, specifications, and product descriptions are finalised at the time of sale and may vary by location. The information provided herein is subject to change without prior notice.

WWW.SECOTOOLS.COM

10033466, ST20206750 GB,
© SECO TOOLS AB, 2021. All rights reserved.
Technical specifications are subject to
change without notice.